

Surge Withstanding Thick Film Chip Resistors

multicomp PRO

**RoHS
Compliant**



Features

- Excellent surge withstanding and pulse withstanding performance
- High power rating
- AEC-Q200 Compliance

Applications

- Metering (Testing/Measurement)
- Medical Devices
- Automotive
- Power supply and Chargers
- Inverters
- LCD Video Monitors

Construction

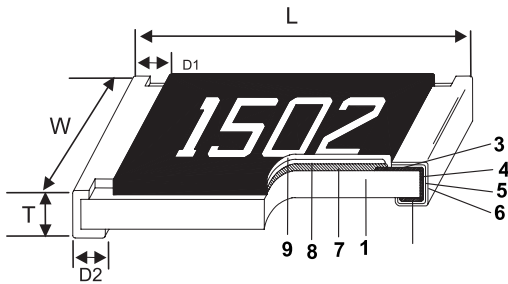

1	Alumina Substrate
2	Bottom Electrode
3	Top Electrode
4	Edge Electrode
5	Barrier Layer

6	External Electrode
7	Resistor Layer
8	Primary Overcoat
9	Secondary Overcoat

Dimensions

Chip size (Inch)	L (mm)	W (mm)	T (mm)	D1 (mm)	D2 (mm)	Weight (g) (1000pcs)
0603	1.6 ±0.1	0.8 ±0.1	0.45 ±0.1	0.3 ±0.2	0.3 ±0.2	2.042
0805	2 ±0.1	1.25 ±0.1	0.5 ±0.1	0.35 ±0.2	0.4 ±0.2	4.368
1206	3.1 ±0.1	1.55 ±0.1	0.55 ±0.1	0.5 ±0.25	0.5 ±0.2	8.947
1210	3.1 ±0.1	2.6 ±0.15	0.55 ±0.1	0.5 ±0.25	0.5 ±0.2	15.959
2010	5 ±0.1	2.5 ±0.15	0.55 ±0.1	0.6 ±0.25	0.5 ±0.2	24.241
2512	6.35 ±0.1	3.1 ±0.15	0.55 ±0.1	0.6 ±0.25	0.5 ±0.2	39.448

Derating Curve

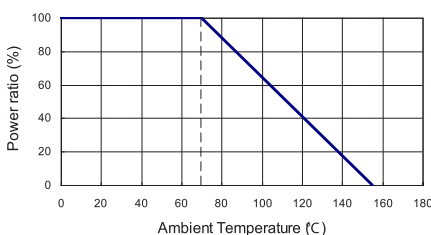

Newark.com/exclusive-brands
Farnell.com/exclusive-brands
Element14.com/exclusive-brands

multicomp PRO

Surge Withstanding Thick Film Chip Resistors

multicomp PRO

Standard Electrical Specifications

Chip size (Inch)	Power Rating at 70°C	Operating Temp. Range	Max. Operating Voltage	Max. Overload Voltage	Resistance Range (E24)			TCR (PPM/°C)
					±5%	±10%	±20%	
0603	1/8W	-55°C to +155°C	50V	100V	10Ω - 270Ω			±200
					300Ω - 1MΩ			±100
0805	1/4W		150V	300V	1Ω - 270Ω			±200
					300Ω - 20MΩ			±100
1206	1/3W		200V	400V	1Ω - 20Ω			±200
					22Ω - 20MΩ			±100
1210	1/2W		200V	400V	1Ω - 20Ω			±200
					22Ω - 20MΩ			±100
2010	3/4W		400V	800V	1Ω - 20Ω			±200
					22Ω - 20MΩ			±100
2512	1.5W	500V	1000V	1Ω - 20Ω			±200	
				22Ω - 20MΩ			±100	

High Power (HP) Rating Electrical Specifications

Chip size (Inch)	Power Rating at 70°C	Operating Temp. Range	Max. Operating Voltage	Max. Overload Voltage	Resistance Range (E24)			TCR (PPM/°C)
					±5%	±10%	±20%	
0603	1/4W	-55°C to +155°C	75V	150V	10Ω - 270Ω			±200
					300Ω - 1MΩ			±100
0805	2/5W		150V	300V	1Ω - 270Ω			±200
					300Ω - 1MΩ			±100
1206	1/2W		200V	400V	1Ω - 20Ω			±200
					22Ω - 1MΩ			±100
1210	3/4W		200V	400V	1Ω - 20Ω			±200
					22Ω - 1MΩ			±100
2010	1W		400V	800V	1Ω - 20Ω			±200
					22Ω - 1MΩ			±100

Operating Voltage = $\sqrt{(P \times R)}$ or Max. Operating Voltage listed above, whichever is lower.

Overload Voltage = $2.5 \times \sqrt{(P \times R)}$ or Max. Overload Voltage listed above, whichever is lower.

Surge Withstanding Thick Film Chip Resistors

multicomp PRO

Environmental Characteristics

Item	Requirement	Test Method
Temperature Coefficient of Resistance (T.C.R.)	As Spec.	JIS-C-5201-1 4.8 IEC-60115-1 4.8 At 25°C/-55°C and 25°C/+125°C, 25°C is the reference temperature
Short Time Overload	$\pm(1.0\%+0.05\Omega)$	JIS-C-5201-1 4.13 IEC-60115-1 4.13 RCWV*2.5 or Max. Overload Voltage whichever is lower for 5 seconds
Insulation Resistance	$\geq 10G$	JIS-C-5201-1 4.6 IEC-60115-1 4.6 Max. Overload Voltage for 1 minute
Endurance	$\pm(3.0\%+0.05\Omega)$	JIS-C-5201-1 4.25 IEC-60115-1 4.25.1 70 \pm 2°C, RCWV for 1000 hrs with 1.5 hrs "ON" and 0.5 hr "OFF"
Damp Heat with Load	$\pm(3.0\%+0.05\Omega)$	JIS-C-5201-1 4.24 IEC-60115-1 4.24 40 \pm 2°C, 90~95% R.H., RCWV for 1000 hrs with 1.5 hr "ON" and 0.5 hrs "OFF"
Dry Heat	$\pm(3.0\%+0.05\Omega)$	JIS-C-5201-1 4.23 IEC-60115-1 4.23.2 at +155°C for 1000 hrs
Bending Strength	$\pm(1.0\%+0.05\Omega)$	JIS-C-5201-1 4.33 IEC-60115-1 4.33 Bending once for 5 seconds 2010, 2512 sizes: 2mm Other sizes: 3mm
Solderability	95% min. coverage	JIS-C-5201-1 4.17 IEC-60115-1 4.17 245 \pm 5°C for 3 seconds
Resistance to Soldering Heat	$\pm(1.0\%+0.05\Omega)$	JIS-C-5201-1 4.18 IEC-60115-1 4.18 260 \pm 5°C for 10 seconds
Voltage Proof	No breakdown or flashover	JIS-C-5201-1 4.7 IEC-60115-1 4.7 1.42 times Max. Operating Voltage for 1 minute
Leaching	Individual leaching area \leq 5% Total leaching area \leq 10%	JIS-C-5201-1 4.18 IEC-60068-2-58 8.2.1 260 \pm 5°C for 30 seconds
Rapid Change of Temperature	$\pm(1.0\%+0.05\Omega)$	JIS-C-5201-1 4.19 IEC-60115-1 4.19 -55°C to +155°C, 5 cycles

RCWV(Rated Continuous Working Voltage)= $\sqrt{P \cdot R}$ or Max. Operating Voltage whichever is lower.

Storage Temperature: 15 to 28°C; Humidity < 80%RH

Newark.com/exclusive-brands
Farnell.com/exclusive-brands
Element14.com/exclusive-brands

multicomp PRO

Surge Withstanding Thick Film Chip Resistors

Soldering Condition

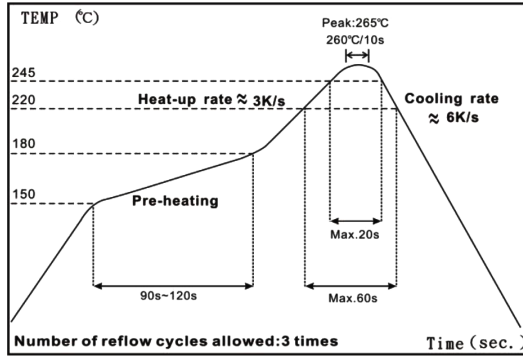

IR Reflow Soldering

(1) Time of IR reflow soldering at maximum temperature point 260°C: 10s

Packaging

Reel Specifications & Packaging Quantity

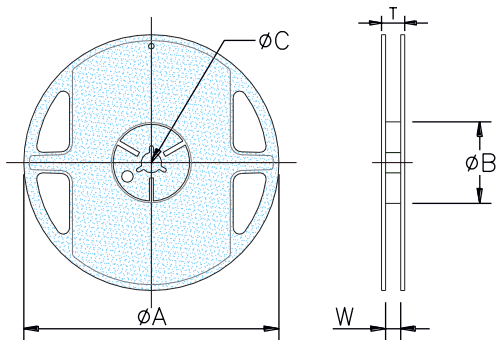

Chip size (Inch)	Packaging Quantity		Tape Width	Reel Diameter	øA (mm)	øB (mm)	øC (mm)	W (mm)	T (mm)
0603	Paper	5K	8mm	7 inch	178.5 ±1.5	60 ^{+1/-0}	13 ±0.2	9 ±0.5	12.5±0.5
0805									
1206									
1210									
2010	Embossed	4K	12mm	7 inch	178.5 ±1.5	60 ^{+1/-0}	13 ±0.5	13 ±0.5	15.5±0.5
2512									

Paper Tape Specifications

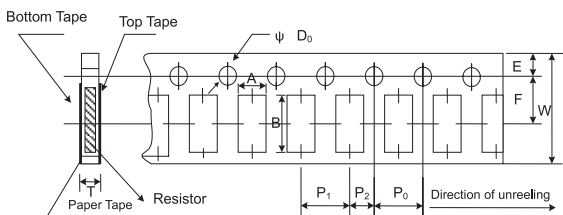

Newark.com/exclusive-brands
Farnell.com/exclusive-brands
Element14.com/exclusive-brands

Surge Withstanding Thick Film Chip Resistors

Chip size (Inch)	A (mm)	B (mm)	W (mm)	E (mm)	F (mm)	P ₀ (mm)	P ₁ (mm)	P ₂ (mm)	ΦD ₀ (mm)	T (mm)
0603	1.1 ±0.1	1.9 ±0.1	8 ±0.2	1.75 ±0.1	3.5 ±0.05	4 ±0.1	4 ±0.05	2 ±0.05	1.5 +0.1,-0	0.7 ±0.1
0805	1.6 ±0.1	2.4 ±0.2	8 ±0.2	1.75 ±0.1	3.5 ±0.05	4 ±0.1	4 ±0.05	2 ±0.05	1.5 +0.1,-0	0.85 ±0.1
1206	1.9 ±0.1	3.5 ±0.2	8 ±0.2	1.75 ±0.1	3.5 ±0.05	4 ±0.1	4 ±0.05	2 ±0.05	1.5 +0.1,-0	0.85 ±0.1
1210	2.9 ±0.1	3.5 ±0.2	8 ±0.2	1.75 ±0.1	3.5 ±0.05	4 ±0.1	4 ±0.05	2 ±0.05	1.5 +0.1,-0	0.85 ±0.1

Embossed Plastic Tape Specifications

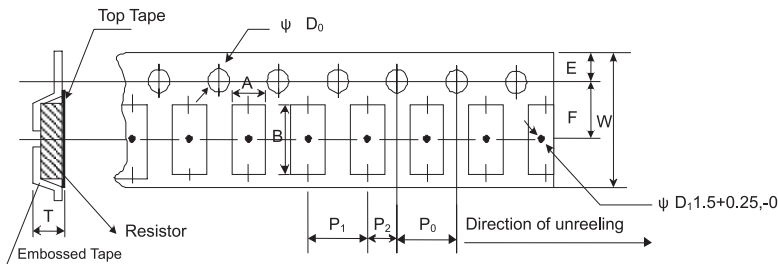

Chip size (Inch)	A (mm)	B (mm)	W (mm)	E (mm)	F (mm)	P ₀ (mm)	P ₁ (mm)	P ₂ (mm)	ΦD ₀ (mm)	T (mm)
2010	2.8 ±0.1	5.5 ±0.1	12 ±0.3	1.75 ±0.1	5.5 ±0.05	4 ±0.1	4 ±0.1	2 ±0.05	1.5 +0.1, -0	1.2 ⁺⁰
2512	3.5 ±0.1	6.7 ±0.1	12 ±0.3	1.75 ±0.1	5.5 ±0.05	4 ±0.1	4 ±0.1	2 ±0.05	1.5 +0.1, -0	1.2 ⁺⁰

Marking

0805 to 2512 4 digits marking for Example

Resistance	100Ω	2.2KΩ	10KΩ	100KΩ	1MΩ
Marking	1000	2201	1002	1003	1004

0603: 3 digits marking in E24

Example: 101=100Ω 102=1KΩ (1st and 2nd are E24 code and 3rd code is multiplier)

E24 code	10	11	12	13	15	16	18	20	22	24	27	30	33	36	39	43	47	51	56	62	68	75	82	91
----------	----	----	----	----	----	----	----	----	----	----	----	----	----	----	----	----	----	----	----	----	----	----	----	----

Recommend Land Pattern

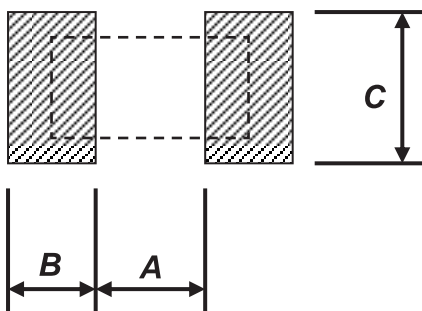

Chip size (Inch)	A (mm)	B (mm)	C (mm)
0603	0.9	0.6	0.9
0805	1.2	0.7	1.3
1206	2	0.9	1.6
1210	2	0.9	2.8
2010	3.8	0.9	2.8
2512	4.9	1	3.4

Surge Withstanding Thick Film Chip Resistors



Lightning Surge

Resistors are tested in accordance with IEC 60115-1 using both 1.2/50us and 10/700 pulse shapes. The limit of acceptance is a shift in resistance of less than 1% from the initial value.

SWR Series 1.2/50us Lightning Surge

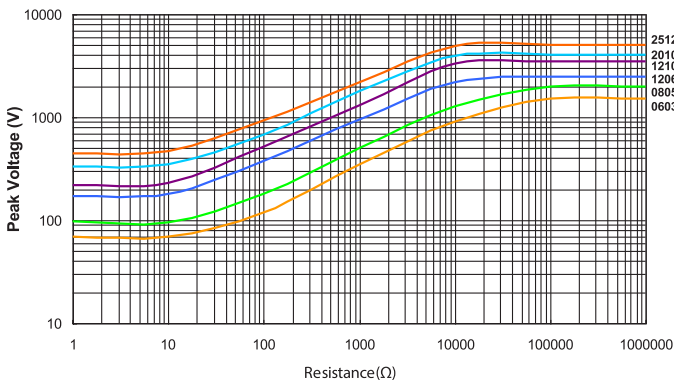

SWR Series 10/700us Lightning Surge

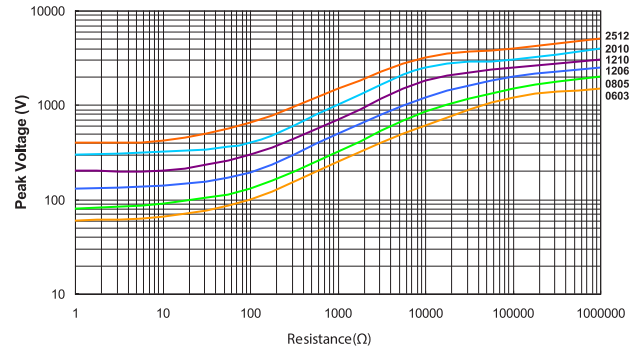

Pulse Withstanding Capacity

The limit of acceptance was a shift in resistance of less than 1% from the initial value. The power applied was subject to the restrictions of the maximum permissible impulse voltage graph shown.

SWR Series Single Pulse(100 Ohm)

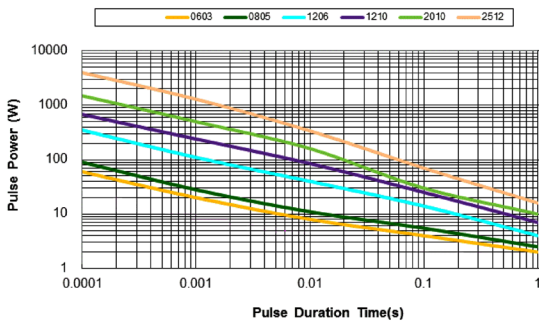

Continuous Pulse

The continuous load graph was obtained by applying repetitive rectangular pulses where the pulse period was adjusted so that the average power dissipated in the resistor was equal to its rated power at 70°C. Again the limit of acceptance was a shift in resistance of less than 1% from the initial value.

SWR Series Continuous Pulse(100 Ohm)

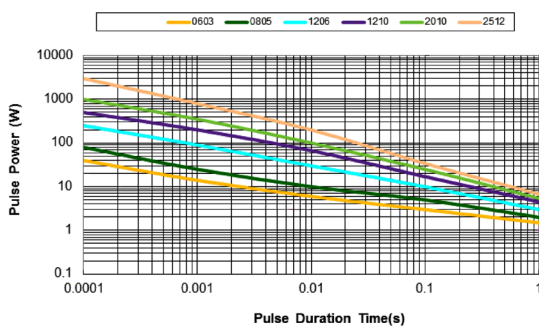

SWR Series Pulse Voltage(100 Ohm)

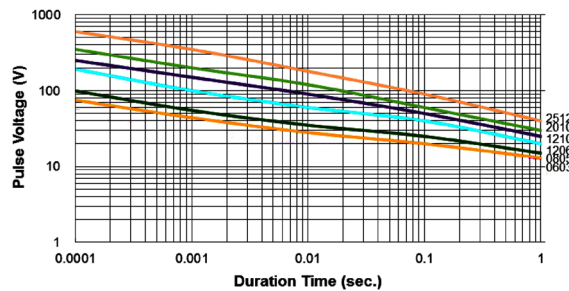

Surge Withstanding Thick Film Chip Resistors

multicomp PRO

Part Number Table

Description	Part Number
Chip Resistor, Surge Withstanding, Thick Film, 5%, 47K Ohm, 1/4W HP, 0603	MP000032
Chip Resistor, Surge Withstanding, Thick Film, 5%, 10K Ohm, 1/8W, 0603	MP000033
Chip Resistor, Surge Withstanding, Thick Film, 5%, 10R Ohm, 1/8W, 0603	MP000034
Chip Resistor, Surge Withstanding, Thick Film, 5%, 1K Ohm, 1/4W, 0805	MP000035
Chip Resistor, Surge Withstanding, Thick Film, 5%, 10K Ohm, 1/4W, 0805	MP000036
Chip Resistor, Surge Withstanding, Thick Film, 5%, 100K Ohm, 1/4W, 0805	MP000037
Chip Resistor, Surge Withstanding, Thick Film, 5%, 120K Ohm, 1/4W, 0805	MP000038
Chip Resistor, Surge Withstanding, Thick Film, 5%, 15K Ohm, 1/4W, 0805	MP000039
Chip Resistor, Surge Withstanding, Thick Film, 5%, 150K Ohm, 1/4W, 0805	MP000040
Chip Resistor, Surge Withstanding, Thick Film, 5%, 2K Ohm, 1/4W, 0805	MP000041
Chip Resistor, Surge Withstanding, Thick Film, 5%, 200K Ohm, 1/4W, 0805	MP000042
Chip Resistor, Surge Withstanding, Thick Film, 5%, 240K Ohm, 1/4W, 0805	MP000043
Chip Resistor, Surge Withstanding, Thick Film, 5%, 300R Ohm, 1/4W, 0805	MP000044
Chip Resistor, Surge Withstanding, Thick Film, 5%, 3K Ohm, 1/4W, 0805	MP000045
Chip Resistor, Surge Withstanding, Thick Film, 5%, 330R Ohm, 1/4W, 0805	MP000046
Chip Resistor, Surge Withstanding, Thick Film, 5%, 3K3 Ohm, 1/4W, 0805	MP000047
Chip Resistor, Surge Withstanding, Thick Film, 5%, 330K Ohm, 1/4W, 0805	MP000048
Chip Resistor, Surge Withstanding, Thick Film, 5%, 4K3 Ohm, 1/4W, 0805	MP000049
Chip Resistor, Surge Withstanding, Thick Film, 5%, 470R Ohm, 1/4W, 0805	MP000050
Chip Resistor, Surge Withstanding, Thick Film, 5%, 4K7 Ohm, 1/4W, 0805	MP000051
Chip Resistor, Surge Withstanding, Thick Film, 5%, 47K Ohm, 1/4W, 0805	MP000052
Chip Resistor, Surge Withstanding, Thick Film, 5%, 4.7M Ohm, 1/4W, 0805	MP000053
Chip Resistor, Surge Withstanding, Thick Film, 5%, 510R Ohm, 1/4W, 0805	MP000054
Chip Resistor, Surge Withstanding, Thick Film, 5%, 68K Ohm, 1/4W, 0805	MP000055
Chip Resistor, Surge Withstanding, Thick Film, 5%, 910R Ohm, 1/4W, 0805	MP000056
Chip Resistor, Surge Withstanding, Thick Film, 5%, 10R Ohm, 2/5W HP, 0805	MP000057
Chip Resistor, Surge Withstanding, Thick Film, 5%, 100R Ohm, 2/5W HP, 0805	MP000058
Chip Resistor, Surge Withstanding, Thick Film, 5%, 1R Ohm, 1/4W, 0805	MP000059
Chip Resistor, Surge Withstanding, Thick Film, 5%, 10R Ohm, 1/4W, 0805	MP000060
Chip Resistor, Surge Withstanding, Thick Film, 5%, 11R Ohm, 1/4W, 0805	MP000061
Chip Resistor, Surge Withstanding, Thick Film, 5%, 15R Ohm, 1/4W, 0805	MP000062
Chip Resistor, Surge Withstanding, Thick Film, 5%, 20R Ohm, 1/4W, 0805	MP000063
Chip Resistor, Surge Withstanding, Thick Film, 5%, 22R Ohm, 1/4W, 0805	MP000064
Chip Resistor, Surge Withstanding, Thick Film, 5%, 30R Ohm, 1/4W, 0805	MP000065
Chip Resistor, Surge Withstanding, Thick Film, 5%, 33R Ohm, 1/4W, 0805	MP000066
Chip Resistor, Surge Withstanding, Thick Film, 5%, 47R Ohm, 1/4W, 0805	MP000067
Chip Resistor, Surge Withstanding, Thick Film, 5%, 51R Ohm, 1/4W, 0805	MP000068
Chip Resistor, Surge Withstanding, Thick Film, 5%, 56R Ohm, 1/4W, 0805	MP000069

Newark.com/exclusive-brands
Farnell.com/exclusive-brands
Element14.com/exclusive-brands

multicomp PRO

Surge Withstanding Thick Film Chip Resistors

multicomp PRO

Description	Part Number
Chip Resistor, Surge Withstanding, Thick Film, 5%, 68R Ohm, 1/4W, 0805	MP000070
Chip Resistor, Surge Withstanding, Thick Film, 5%, 75R Ohm, 1/4W, 0805	MP000071
Chip Resistor, Surge Withstanding, Thick Film, 5%, 100R Ohm, 1/4W, 0805	MP000072
Chip Resistor, Surge Withstanding, Thick Film, 5%, 150R Ohm, 1/4W, 0805	MP000073
Chip Resistor, Surge Withstanding, Thick Film, 5%, 220R Ohm, 1/4W, 0805	MP000074
Chip Resistor, Surge Withstanding, Thick Film, 5%, 2R2 Ohm, 1/4W, 0805	MP000075
Chip Resistor, Surge Withstanding, Thick Film, 5%, 3R3 Ohm, 1/4W, 0805	MP000076
Chip Resistor, Surge Withstanding, Thick Film, 5%, 4R7 Ohm, 1/4W, 0805	MP000077
Chip Resistor, Surge Withstanding, Thick Film, 5%, 5R1 Ohm, 1/4W, 0805	MP000078
Chip Resistor, Surge Withstanding, Thick Film, 5%, 5R6 Ohm, 1/4W, 0805	MP000079
Chip Resistor, Surge Withstanding, Thick Film, 5%, 6R8 Ohm, 1/4W, 0805	MP000080
Chip Resistor, Surge Withstanding, Thick Film, 5%, 7R5 Ohm, 1/4W, 0805	MP000081
Chip Resistor, Surge Withstanding, Thick Film, 5%, 8R2 Ohm, 1/4W, 0805	MP000082
Chip Resistor, Surge Withstanding, Thick Film, 5%, 22R Ohm, 1/3W, 1206	MP000083
Chip Resistor, Surge Withstanding, Thick Film, 5%, 39R Ohm, 1/3W, 1206	MP000084
Chip Resistor, Surge Withstanding, Thick Film, 5%, 47R Ohm, 1/3W, 1206	MP000085
Chip Resistor, Surge Withstanding, Thick Film, 5%, 100R Ohm, 1/3W, 1206	MP000086
Chip Resistor, Surge Withstanding, Thick Film, 5%, 1K Ohm, 1/3W, 1206	MP000087
Chip Resistor, Surge Withstanding, Thick Film, 5%, 10K Ohm, 1/3W, 1206	MP000088
Chip Resistor, Surge Withstanding, Thick Film, 5%, 100K Ohm, 1/3W, 1206	MP000089
Chip Resistor, Surge Withstanding, Thick Film, 5%, 1M Ohm, 1/3W, 1206	MP000090
Chip Resistor, Surge Withstanding, Thick Film, 5%, 1K2 Ohm, 1/3W, 1206	MP000091
Chip Resistor, Surge Withstanding, Thick Film, 5%, 130K Ohm, 1/3W, 1206	MP000092
Chip Resistor, Surge Withstanding, Thick Film, 5%, 150R Ohm, 1/3W, 1206	MP000093
Chip Resistor, Surge Withstanding, Thick Film, 5%, 1K5 Ohm, 1/3W, 1206	MP000094
Chip Resistor, Surge Withstanding, Thick Film, 5%, 150K Ohm, 1/3W, 1206	MP000095
Chip Resistor, Surge Withstanding, Thick Film, 5%, 1K8 Ohm, 1/3W, 1206	MP000096
Chip Resistor, Surge Withstanding, Thick Film, 5%, 200R Ohm, 1/3W, 1206	MP000097
Chip Resistor, Surge Withstanding, Thick Film, 5%, 2K4 Ohm, 1/3W, 1206	MP000098
Chip Resistor, Surge Withstanding, Thick Film, 5%, 24K Ohm, 1/3W, 1206	MP000099
Chip Resistor, Surge Withstanding, Thick Film, 5%, 240K Ohm, 1/3W, 1206	MP000100
Chip Resistor, Surge Withstanding, Thick Film, 5%, 2K7 Ohm, 1/3W, 1206	MP000101
Chip Resistor, Surge Withstanding, Thick Film, 5%, 270K Ohm, 1/3W, 1206	MP000102
Chip Resistor, Surge Withstanding, Thick Film, 5%, 3K Ohm, 1/3W, 1206	MP000103
Chip Resistor, Surge Withstanding, Thick Film, 5%, 300K Ohm, 1/3W, 1206	MP000104
Chip Resistor, Surge Withstanding, Thick Film, 5%, 330R Ohm, 1/3W, 1206	MP000105
Chip Resistor, Surge Withstanding, Thick Film, 5%, 3K3 Ohm, 1/3W, 1206	MP000106
Chip Resistor, Surge Withstanding, Thick Film, 5%, 330K Ohm, 1/3W, 1206	MP000107
Chip Resistor, Surge Withstanding, Thick Film, 5%, 3K9 Ohm, 1/3W, 1206	MP000108

Newark.com/exclusive-brands
Farnell.com/exclusive-brands
Element14.com/exclusive-brands

multicomp PRO

Surge Withstanding Thick Film Chip Resistors

multicomp PRO

Description	Part Number
Chip Resistor, Surge Withstanding, Thick Film, 5%, 43K Ohm, 1/3W, 1206	MP000109
Chip Resistor, Surge Withstanding, Thick Film, 5%, 470R Ohm, 1/3W, 1206	MP000110
Chip Resistor, Surge Withstanding, Thick Film, 5%, 4K7 Ohm, 1/3W, 1206	MP000111
Chip Resistor, Surge Withstanding, Thick Film, 5%, 47K Ohm, 1/3W, 1206	MP000112
Chip Resistor, Surge Withstanding, Thick Film, 5%, 470K Ohm, 1/3W, 1206	MP000113
Chip Resistor, Surge Withstanding, Thick Film, 5%, 4.7M Ohm, 1/3W, 1206	MP000114
Chip Resistor, Surge Withstanding, Thick Film, 5%, 510R Ohm, 1/3W, 1206	MP000115
Chip Resistor, Surge Withstanding, Thick Film, 5%, 820R Ohm, 1/3W, 1206	MP000116
Chip Resistor, Surge Withstanding, Thick Film, 5%, 75R Ohm, 1/2W HP, 1206	MP000117
Chip Resistor, Surge Withstanding, Thick Film, 5%, 100R Ohm, 1/2W HP, 1206	MP000118
Chip Resistor, Surge Withstanding, Thick Film, 5%, 1K Ohm, 1/2W HP, 1206	MP000119
Chip Resistor, Surge Withstanding, Thick Film, 5%, 200R Ohm, 1/2W HP, 1206	MP000120
Chip Resistor, Surge Withstanding, Thick Film, 5%, 240R Ohm, 1/2W HP, 1206	MP000121
Chip Resistor, Surge Withstanding, Thick Film, 5%, 300R Ohm, 1/2W HP, 1206	MP000122
Chip Resistor, Surge Withstanding, Thick Film, 5%, 300K Ohm, 1/2W HP, 1206	MP000123
Chip Resistor, Surge Withstanding, Thick Film, 5%, 470R Ohm, 1/2W HP, 1206	MP000124
Chip Resistor, Surge Withstanding, Thick Film, 5%, 1R Ohm, 1/3W, 1206	MP000125
Chip Resistor, Surge Withstanding, Thick Film, 5%, 2R Ohm, 1/3W, 1206	MP000126
Chip Resistor, Surge Withstanding, Thick Film, 5%, 3R Ohm, 1/3W, 1206	MP000127
Chip Resistor, Surge Withstanding, Thick Film, 5%, 10R Ohm, 1/3W, 1206	MP000128
Chip Resistor, Surge Withstanding, Thick Film, 5%, 15R Ohm, 1/3W, 1206	MP000129
Chip Resistor, Surge Withstanding, Thick Film, 5%, 1R5 Ohm, 1/3W, 1206	MP000130
Chip Resistor, Surge Withstanding, Thick Film, 5%, 1R8 Ohm, 1/3W, 1206	MP000131
Chip Resistor, Surge Withstanding, Thick Film, 5%, 2R2 Ohm, 1/3W, 1206	MP000132
Chip Resistor, Surge Withstanding, Thick Film, 5%, 3R3 Ohm, 1/3W, 1206	MP000133
Chip Resistor, Surge Withstanding, Thick Film, 5%, 4R7 Ohm, 1/3W, 1206	MP000134
Chip Resistor, Surge Withstanding, Thick Film, 5%, 5R6 Ohm, 1/3W, 1206	MP000135
Chip Resistor, Surge Withstanding, Thick Film, 5%, 6R8 Ohm, 1/3W, 1206	MP000136
Chip Resistor, Surge Withstanding, Thick Film, 5%, 3R Ohm, 1/2W HP, 1206	MP000137
Chip Resistor, Surge Withstanding, Thick Film, 5%, 10R Ohm, 1/2W HP, 1206	MP000138
Chip Resistor, Surge Withstanding, Thick Film, 5%, 15R Ohm, 1/2W HP, 1206	MP000139
Chip Resistor, Surge Withstanding, Thick Film, 5%, 20R Ohm, 1/2W HP, 1206	MP000140
Chip Resistor, Surge Withstanding, Thick Film, 5%, 4R7 Ohm, 1/2W HP, 1206	MP000141
Chip Resistor, Surge Withstanding, Thick Film, 5%, 5R1 Ohm, 1/2W HP, 1206	MP000142
Chip Resistor, Surge Withstanding, Thick Film, 5%, 22R Ohm, 3/4W, 2010	MP000143
Chip Resistor, Surge Withstanding, Thick Film, 5%, 24R Ohm, 3/4W, 2010	MP000144
Chip Resistor, Surge Withstanding, Thick Film, 5%, 27R Ohm, 3/4W, 2010	MP000145
Chip Resistor, Surge Withstanding, Thick Film, 5%, 33R Ohm, 3/4W, 2010	MP000146
Chip Resistor, Surge Withstanding, Thick Film, 5%, 39R Ohm, 3/4W, 2010	MP000147

Newark.com/exclusive-brands
Farnell.com/exclusive-brands
Element14.com/exclusive-brands

multicomp PRO

Surge Withstanding Thick Film Chip Resistors

multicomp PRO

Description	Part Number
Chip Resistor, Surge Withstanding, Thick Film, 5%, 47R Ohm, 3/4W, 2010	MP000148
Chip Resistor, Surge Withstanding, Thick Film, 5%, 51R Ohm, 3/4W, 2010	MP000149
Chip Resistor, Surge Withstanding, Thick Film, 5%, 56R Ohm, 3/4W, 2010	MP000150
Chip Resistor, Surge Withstanding, Thick Film, 5%, 82R Ohm, 3/4W, 2010	MP000151
Chip Resistor, Surge Withstanding, Thick Film, 5%, 100R Ohm, 3/4W, 2010	MP000152
Chip Resistor, Surge Withstanding, Thick Film, 5%, 1K Ohm, 3/4W, 2010	MP000153
Chip Resistor, Surge Withstanding, Thick Film, 5%, 10K Ohm, 3/4W, 2010	MP000154
Chip Resistor, Surge Withstanding, Thick Film, 5%, 100K Ohm, 3/4W, 2010	MP000155
Chip Resistor, Surge Withstanding, Thick Film, 5%, 1M Ohm, 3/4W, 2010	MP000156
Chip Resistor, Surge Withstanding, Thick Film, 5%, 120R Ohm, 3/4W, 2010	MP000157
Chip Resistor, Surge Withstanding, Thick Film, 5%, 12K Ohm, 3/4W, 2010	MP000158
Chip Resistor, Surge Withstanding, Thick Film, 5%, 150R Ohm, 3/4W, 2010	MP000159
Chip Resistor, Surge Withstanding, Thick Film, 5%, 1K5 Ohm, 3/4W, 2010	MP000160
Chip Resistor, Surge Withstanding, Thick Film, 5%, 150K Ohm, 3/4W, 2010	MP000161
Chip Resistor, Surge Withstanding, Thick Film, 5%, 220R Ohm, 3/4W, 2010	MP000162
Chip Resistor, Surge Withstanding, Thick Film, 5%, 24K Ohm, 3/4W, 2010	MP000163
Chip Resistor, Surge Withstanding, Thick Film, 5%, 270R Ohm, 3/4W, 2010	MP000164
Chip Resistor, Surge Withstanding, Thick Film, 5%, 27K Ohm, 3/4W, 2010	MP000165
Chip Resistor, Surge Withstanding, Thick Film, 5%, 270K Ohm, 3/4W, 2010	MP000166
Chip Resistor, Surge Withstanding, Thick Film, 5%, 300R Ohm, 3/4W, 2010	MP000167
Chip Resistor, Surge Withstanding, Thick Film, 5%, 330R Ohm, 3/4W, 2010	MP000168
Chip Resistor, Surge Withstanding, Thick Film, 5%, 3K3 Ohm, 3/4W, 2010	MP000169
Chip Resistor, Surge Withstanding, Thick Film, 5%, 360R Ohm, 3/4W, 2010	MP000170
Chip Resistor, Surge Withstanding, Thick Film, 5%, 430R Ohm, 3/4W, 2010	MP000171
Chip Resistor, Surge Withstanding, Thick Film, 5%, 470R Ohm, 3/4W, 2010	MP000172
Chip Resistor, Surge Withstanding, Thick Film, 5%, 4K7 Ohm, 3/4W, 2010	MP000173
Chip Resistor, Surge Withstanding, Thick Film, 5%, 5K1 Ohm, 3/4W, 2010	MP000174
Chip Resistor, Surge Withstanding, Thick Film, 5%, 510K Ohm, 3/4W, 2010	MP000175
Chip Resistor, Surge Withstanding, Thick Film, 5%, 560K Ohm, 3/4W, 2010	MP000176
Chip Resistor, Surge Withstanding, Thick Film, 5%, 620R Ohm, 3/4W, 2010	MP000177
Chip Resistor, Surge Withstanding, Thick Film, 5%, 680R Ohm, 3/4W, 2010	MP000178
Chip Resistor, Surge Withstanding, Thick Film, 5%, 75K Ohm, 3/4W, 2010	MP000179
Chip Resistor, Surge Withstanding, Thick Film, 5%, 100R Ohm, 1W HP, 2010	MP000180
Chip Resistor, Surge Withstanding, Thick Film, 5%, 1R Ohm, 3/4W, 2010	MP000181
Chip Resistor, Surge Withstanding, Thick Film, 5%, 2R Ohm, 3/4W, 2010	MP000182
Chip Resistor, Surge Withstanding, Thick Film, 5%, 3R Ohm, 3/4W, 2010	MP000183
Chip Resistor, Surge Withstanding, Thick Film, 5%, 10R Ohm, 3/4W, 2010	MP000184
Chip Resistor, Surge Withstanding, Thick Film, 5%, 15R Ohm, 3/4W, 2010	MP000185
Chip Resistor, Surge Withstanding, Thick Film, 5%, 18R Ohm, 3/4W, 2010	MP000186

Newark.com/exclusive-brands
Farnell.com/exclusive-brands
Element14.com/exclusive-brands

multicomp PRO

Surge Withstanding Thick Film Chip Resistors

multicomp PRO

Description	Part Number
Chip Resistor, Surge Withstanding, Thick Film, 5%, 2R2 Ohm, 3/4W, 2010	MP000187
Chip Resistor, Surge Withstanding, Thick Film, 5%, 2R7 Ohm, 3/4W, 2010	MP000188
Chip Resistor, Surge Withstanding, Thick Film, 5%, 4R7 Ohm, 3/4W, 2010	MP000189
Chip Resistor, Surge Withstanding, Thick Film, 5%, 6R8 Ohm, 3/4W, 2010	MP000190
Chip Resistor, Surge Withstanding, Thick Film, 5%, 8R2 Ohm, 1W HP, 2010	MP000191
Chip Resistor, Surge Withstanding, Thick Film, 5%, 22R Ohm, 1.5W, 2512	MP000192
Chip Resistor, Surge Withstanding, Thick Film, 5%, 24R Ohm, 1.5W, 2512	MP000193
Chip Resistor, Surge Withstanding, Thick Film, 5%, 27R Ohm, 1.5W, 2512	MP000194
Chip Resistor, Surge Withstanding, Thick Film, 5%, 33R Ohm, 1.5W, 2512	MP000195
Chip Resistor, Surge Withstanding, Thick Film, 5%, 36R Ohm, 1.5W, 2512	MP000196
Chip Resistor, Surge Withstanding, Thick Film, 5%, 39R Ohm, 1.5W, 2512	MP000197
Chip Resistor, Surge Withstanding, Thick Film, 5%, 47R Ohm, 1.5W, 2512	MP000198
Chip Resistor, Surge Withstanding, Thick Film, 5%, 51R Ohm, 1.5W, 2512	MP000199
Chip Resistor, Surge Withstanding, Thick Film, 5%, 68R Ohm, 1.5W, 2512	MP000200
Chip Resistor, Surge Withstanding, Thick Film, 5%, 82R Ohm, 1.5W, 2512	MP000201
Chip Resistor, Surge Withstanding, Thick Film, 5%, 100R Ohm, 1.5W, 2512	MP000202
Chip Resistor, Surge Withstanding, Thick Film, 5%, 1K Ohm, 1.5W, 2512	MP000203
Chip Resistor, Surge Withstanding, Thick Film, 5%, 10K Ohm, 1.5W, 2512	MP000204
Chip Resistor, Surge Withstanding, Thick Film, 5%, 100K Ohm, 1.5W, 2512	MP000205
Chip Resistor, Surge Withstanding, Thick Film, 5%, 1M Ohm, 1.5W, 2512	MP000206
Chip Resistor, Surge Withstanding, Thick Film, 5%, 120R Ohm, 1.5W, 2512	MP000207
Chip Resistor, Surge Withstanding, Thick Film, 5%, 1.2M Ohm, 1.5W, 2512	MP000208
Chip Resistor, Surge Withstanding, Thick Film, 5%, 150R Ohm, 1.5W, 2512	MP000209
Chip Resistor, Surge Withstanding, Thick Film, 5%, 1K5 Ohm, 1.5W, 2512	MP000210
Chip Resistor, Surge Withstanding, Thick Film, 5%, 150K Ohm, 1.5W, 2512	MP000211
Chip Resistor, Surge Withstanding, Thick Film, 5%, 160R Ohm, 1.5W, 2512	MP000212
Chip Resistor, Surge Withstanding, Thick Film, 5%, 16K Ohm, 1.5W, 2512	MP000213
Chip Resistor, Surge Withstanding, Thick Film, 5%, 180R Ohm, 1.5W, 2512	MP000214
Chip Resistor, Surge Withstanding, Thick Film, 5%, 180K Ohm, 1.5W, 2512	MP000215
Chip Resistor, Surge Withstanding, Thick Film, 5%, 200R Ohm, 1.5W, 2512	MP000216
Chip Resistor, Surge Withstanding, Thick Film, 5%, 2K Ohm, 1.5W, 2512	MP000217
Chip Resistor, Surge Withstanding, Thick Film, 5%, 20K Ohm, 1.5W, 2512	MP000218
Chip Resistor, Surge Withstanding, Thick Film, 5%, 200K Ohm, 1.5W, 2512	MP000219
Chip Resistor, Surge Withstanding, Thick Film, 5%, 220R Ohm, 1.5W, 2512	MP000220
Chip Resistor, Surge Withstanding, Thick Film, 5%, 240K Ohm, 1.5W, 2512	MP000221
Chip Resistor, Surge Withstanding, Thick Film, 5%, 270R Ohm, 1.5W, 2512	MP000222
Chip Resistor, Surge Withstanding, Thick Film, 5%, 2K7 Ohm, 1.5W, 2512	MP000223
Chip Resistor, Surge Withstanding, Thick Film, 5%, 300R Ohm, 1.5W, 2512	MP000224
Chip Resistor, Surge Withstanding, Thick Film, 5%, 30K Ohm, 1.5W, 2512	MP000225

Newark.com/exclusive-brands
Farnell.com/exclusive-brands
Element14.com/exclusive-brands

multicomp PRO

Surge Withstanding Thick Film Chip Resistors

multicomp PRO

Description	Part Number
Chip Resistor, Surge Withstanding, Thick Film, 5%, 330R Ohm, 1.5W, 2512	MP000226
Chip Resistor, Surge Withstanding, Thick Film, 5%, 3K3 Ohm, 1.5W, 2512	MP000227
Chip Resistor, Surge Withstanding, Thick Film, 5%, 330K Ohm, 1.5W, 2512	MP000228
Chip Resistor, Surge Withstanding, Thick Film, 5%, 36K Ohm, 1.5W, 2512	MP000229
Chip Resistor, Surge Withstanding, Thick Film, 5%, 390R Ohm, 1.5W, 2512	MP000230
Chip Resistor, Surge Withstanding, Thick Film, 5%, 430R Ohm, 1.5W, 2512	MP000231
Chip Resistor, Surge Withstanding, Thick Film, 5%, 43K Ohm, 1.5W, 2512	MP000232
Chip Resistor, Surge Withstanding, Thick Film, 5%, 470R Ohm, 1.5W, 2512	MP000233
Chip Resistor, Surge Withstanding, Thick Film, 5%, 4K7 Ohm, 1.5W, 2512	MP000234
Chip Resistor, Surge Withstanding, Thick Film, 5%, 47K Ohm, 1.5W, 2512	MP000235
Chip Resistor, Surge Withstanding, Thick Film, 5%, 470K Ohm, 1.5W, 2512	MP000236
Chip Resistor, Surge Withstanding, Thick Film, 5%, 510R Ohm, 1.5W, 2512	MP000237
Chip Resistor, Surge Withstanding, Thick Film, 5%, 560R Ohm, 1.5W, 2512	MP000238
Chip Resistor, Surge Withstanding, Thick Film, 5%, 56K Ohm, 1.5W, 2512	MP000239
Chip Resistor, Surge Withstanding, Thick Film, 5%, 5.6M Ohm, 1.5W, 2512	MP000240
Chip Resistor, Surge Withstanding, Thick Film, 5%, 620R Ohm, 1.5W, 2512	MP000241
Chip Resistor, Surge Withstanding, Thick Film, 5%, 680R Ohm, 1.5W, 2512	MP000242
Chip Resistor, Surge Withstanding, Thick Film, 5%, 68K Ohm, 1.5W, 2512	MP000243
Chip Resistor, Surge Withstanding, Thick Film, 5%, 7K5 Ohm, 1.5W, 2512	MP000244
Chip Resistor, Surge Withstanding, Thick Film, 5%, 75K Ohm, 1.5W, 2512	MP000245
Chip Resistor, Surge Withstanding, Thick Film, 5%, 750K Ohm, 1.5W, 2512	MP000246
Chip Resistor, Surge Withstanding, Thick Film, 5%, 820R Ohm, 1.5W, 2512	MP000247
Chip Resistor, Surge Withstanding, Thick Film, 5%, 82K Ohm, 1.5W, 2512	MP000248
Chip Resistor, Surge Withstanding, Thick Film, 5%, 1R Ohm, 1.5W, 2512	MP000249
Chip Resistor, Surge Withstanding, Thick Film, 5%, 2R Ohm, 1.5W, 2512	MP000250
Chip Resistor, Surge Withstanding, Thick Film, 5%, 3R Ohm, 1.5W, 2512	MP000251
Chip Resistor, Surge Withstanding, Thick Film, 5%, 10R Ohm, 1.5W, 2512	MP000252
Chip Resistor, Surge Withstanding, Thick Film, 5%, 12R Ohm, 1.5W, 2512	MP000253
Chip Resistor, Surge Withstanding, Thick Film, 5%, 13R Ohm, 1.5W, 2512	MP000254
Chip Resistor, Surge Withstanding, Thick Film, 5%, 15R Ohm, 1.5W, 2512	MP000255
Chip Resistor, Surge Withstanding, Thick Film, 5%, 18R Ohm, 1.5W, 2512	MP000256
Chip Resistor, Surge Withstanding, Thick Film, 5%, 20R Ohm, 1.5W, 2512	MP000257
Chip Resistor, Surge Withstanding, Thick Film, 5%, 1R2 Ohm, 1.5W, 2512	MP000258
Chip Resistor, Surge Withstanding, Thick Film, 5%, 1R3 Ohm, 1.5W, 2512	MP000259
Chip Resistor, Surge Withstanding, Thick Film, 5%, 1R5 Ohm, 1.5W, 2512	MP000260
Chip Resistor, Surge Withstanding, Thick Film, 5%, 2R2 Ohm, 1.5W, 2512	MP000261
Chip Resistor, Surge Withstanding, Thick Film, 5%, 3R3 Ohm, 1.5W, 2512	MP000262
Chip Resistor, Surge Withstanding, Thick Film, 5%, 3R9 Ohm, 1.5W, 2512	MP000263
Chip Resistor, Surge Withstanding, Thick Film, 5%, 4R7 Ohm, 1.5W, 2512	MP000264

Newark.com/exclusive-brands
Farnell.com/exclusive-brands
Element14.com/exclusive-brands

multicomp PRO

Surge Withstanding Thick Film Chip Resistors

multicomp PRO

Description	Part Number
Chip Resistor, Surge Withstanding, Thick Film, 5%, 5R1 Ohm, 1.5W, 2512	MP000265
Chip Resistor, Surge Withstanding, Thick Film, 5%, 6R8 Ohm, 1.5W, 2512	MP000266
Chip Resistor, Surge Withstanding, Thick Film, 5%, 7R5 Ohm, 1.5W, 2512	MP000267
Chip Resistor, Surge Withstanding, Thick Film, 5%, 8R2 Ohm, 1.5W, 2512	MP000268
Chip Resistor, Surge Withstanding, Thick Film, 5%, 68R Ohm, 3/4W HP, 1210	MP000269
Chip Resistor, Surge Withstanding, Thick Film, 5%, 820R Ohm, 3/4W HP, 1210	MP000270
Chip Resistor, Surge Withstanding, Thick Film, 5%, 22R Ohm, 1/2W, 1210	MP000271
Chip Resistor, Surge Withstanding, Thick Film, 5%, 33R Ohm, 1/2W, 1210	MP000272
Chip Resistor, Surge Withstanding, Thick Film, 5%, 100R Ohm, 1/2W, 1210	MP000273
Chip Resistor, Surge Withstanding, Thick Film, 5%, 1K Ohm, 1/2W, 1210	MP000274
Chip Resistor, Surge Withstanding, Thick Film, 5%, 180R Ohm, 1/2W, 1210	MP000275
Chip Resistor, Surge Withstanding, Thick Film, 5%, 220R Ohm, 1/2W, 1210	MP000276
Chip Resistor, Surge Withstanding, Thick Film, 5%, 2K4 Ohm, 1/2W, 1210	MP000277
Chip Resistor, Surge Withstanding, Thick Film, 5%, 270R Ohm, 1/2W, 1210	MP000278
Chip Resistor, Surge Withstanding, Thick Film, 5%, 620R Ohm, 1/2W, 1210	MP000279
Chip Resistor, Surge Withstanding, Thick Film, 5%, 68K Ohm, 1/2W, 1210	MP000280
Chip Resistor, Surge Withstanding, Thick Film, 5%, 750R Ohm, 1/2W, 1210	MP000281
Chip Resistor, Surge Withstanding, Thick Film, 5%, 1R Ohm, 1/2W, 1210	MP000282
Chip Resistor, Surge Withstanding, Thick Film, 5%, 2R Ohm, 1/2W, 1210	MP000283
Chip Resistor, Surge Withstanding, Thick Film, 5%, 10R Ohm, 1/2W, 1210	MP000284
Chip Resistor, Surge Withstanding, Thick Film, 5%, 12R Ohm, 1/2W, 1210	MP000285
Chip Resistor, Surge Withstanding, Thick Film, 5%, 15R Ohm, 1/2W, 1210	MP000286
Chip Resistor, Surge Withstanding, Thick Film, 5%, 20R Ohm, 1/2W, 1210	MP000287
Chip Resistor, Surge Withstanding, Thick Film, 5%, 2R2 Ohm, 1/2W, 1210	MP000288
Chip Resistor, Surge Withstanding, Thick Film, 5%, 3R9 Ohm, 1/2W, 1210	MP000289

Important Notice : This data sheet and its contents (the "Information") belong to the members of the AVNET group of companies (the "Group") or are licensed to it. No licence is granted for the use of it other than for information purposes in connection with the products to which it relates. No licence of any intellectual property rights is granted. The Information is subject to change without notice and replaces all data sheets previously supplied. The Information supplied is believed to be accurate but the Group assumes no responsibility for its accuracy or completeness, any error in or omission from it or for any use made of it. Users of this data sheet should check for themselves the Information and the suitability of the products for their purpose and not make any assumptions based on information included or omitted. Liability for loss or damage resulting from any reliance on the Information or use of it (including liability resulting from negligence or where the Group was aware of the possibility of such loss or damage arising) is excluded. This will not operate to limit or restrict the Group's liability for death or personal injury resulting from its negligence. Multicomp Pro is the registered trademark of Premier Farnell Limited 2019.

Newark.com/exclusive-brands
Farnell.com/exclusive-brands
Element14.com/exclusive-brands

multicomp PRO