



ENGLISH

Datasheet

RS Pro Carbide PCB Drill Bit 0.9mm

RS Stock No: **457-639**



Product Details

RS Pro tungsten carbide drill bit has a diameter of 0.8 mm. The miniature solid drill bit has a shoulder shank for easy handling. This drill bit is suitable for PCB drilling and provides clean hole on multi layer PCB boards or standard circuit boards.

Features and Benefits

- Tungsten carbide
- Diameter of 0.9 mm
- Shoulder shank for easy handling
- Suitable for PCB drilling
- Provides clean hole on multi layer PCB boards or standard circuit boards



ENGLISH

Specifications:

| | |
|----------------|----------|
| Diameter | 0.9 mm |
| Material | Carbide |
| Flute Length | 9.5 mm |
| Overall Length | 38 mm |
| Shank Diameter | 3.175 mm |

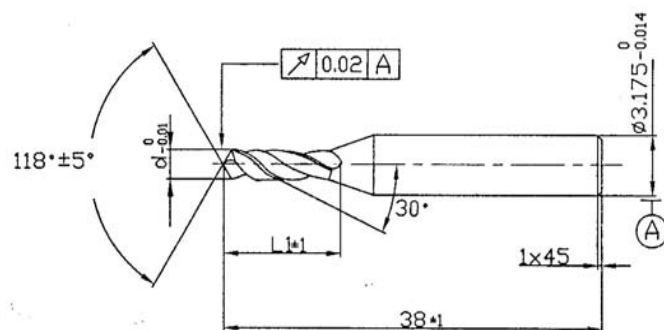

| RS STOCK NUMBER | MANUFACTURE PART NO. | DESCRIPTION | DIA.(d)mm | TOLERENC E(mm) | OVERALL LENGTH(mm) | FLUTE LENGTH(L1)m m |
|-----------------|----------------------|---------------------------|-----------|----------------|--------------------|---------------------|
| 457594 | TM200-0050 | Tungsten drill bit 0.5mm | 0.5 | -0.01 | 38±1 | 4.8±1 |
| 457645 | TM200-0060 | Tungsten drill bit 0.6mm | 0.6 | -0.01 | 38±1 | 6.5±1 |
| 457649 | TM200-0070 | Tungsten drill bit 0.7mm | 0.7 | -0.01 | 38±1 | 8.5±1 |
| 457633 | TM200-0080 | Tugsten drill bit0.8mm | 0.8 | -0.01 | 38±1 | 9.5±1 |
| 457639 | TM200-0090 | Tungsten drill bit 0.9mm | 0.9 | -0.01 | 38±1 | 9.5±1 |
| 457655 | TM200-0100 | Tungsten drill bit 1.0mm | 1.0 | -0.01 | 38±1 | 10.5±1 |
| 457623 | TM200-0110 | Tungsten drill bit 1.1mm | 1.1 | -0.01 | 38±1 | 10.5±1 |
| 457673 | TM200-0120 | Tungseten drill bit 1.2mm | 1.2 | -0.01 | 38±1 | 10.5±1 |
| 457677 | TM200-0130 | Tungsten drill bit 1.3mm | 1.3 | -0.01 | 38±1 | 10.5±1 |
| 457667 | TM200-0140 | Tungsten drill bit 1.4mm | 1.4 | -0.01 | 38±1 | 10.5±1 |
| 457661 | TM200-0150 | Tungsten drill bit 1.5mm | 1.5 | -0.01 | 38±1 | 10.5±1 |

Remarks:

- Material: Tungsten carbide
- Shank Dia.: 1/8"