

## Datasheet

Stock No: 286-3702

# RS Pro Round Tube Handrail Bracket, strut profile Type 3



## Product Details

Hand Rail Bracket, Wall Fixing

Can also be used to fix structures to walls or for the attachment of kicking boards to the base of an upright

Dimensions (mm)					
Tube Size Ref.	B	C	D	E	F
1	57	44	82	63	10
2	63	44	102	76	10
3	67	48	108	85	10

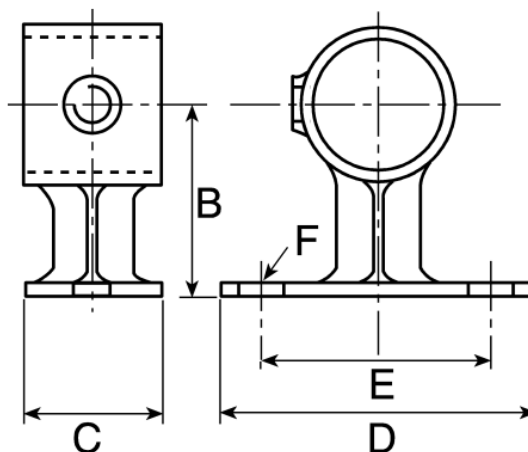



## Specifications:

Structural Element Type	Round Tube
Connector Type	Handrail Bracket
Fits Strut Profile	Type 3
Fits Tube Diameter	48.3mm
Product Family	RS Handrail System
Material	Cast Iron
Product System	143

### Staircase Fittings

The line drawing illustrates some typical applications of the fittings for the construction of staircase handrails.

For Tube Size Refs. 1, 2 and 3.

The 'selection guide' table links the alphabetical key in the illustration to the specific fittings (a typical stock number is also quoted).

Selection Guide		
Key	Fitting Description	Typical Stock No.
H	90° Elbow	286-3370
M	Rail Base Flange	286-3623
Q	Single Mesh Panel Clip	415-7037
S	Handrail bracket	286-3689
T	Single swivel combination	286-3522
U	Double swivel combination	286-3544
V	Variable elbow 15° to 60°	415-5968
W	Adj. Short tee 30° to 60°	415-6006
X	Two socket cross adj. 30° to 45°	415-6034
Y	Short tee swivel	415-6191
Z	Plastic stop end	286-3718

### Note

The 'selection guide' table links the alphabetical key in the illustration to the specific fittings (a typical stock number is also quoted).