



ENGLISH

Datasheet

Stock No: 394443

RS PRO Toggle Switch



Feature:
ON-OFF-ON
16.00 high
8.00 high,keyway, (thd)
Solder Lug
Silver
EPOXY (std)
RoHS & Lead Free

Code symbol:
2MS3
TL1
B25
M1
Q
E
S

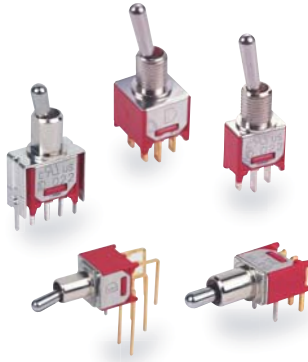

SPECIFICATIONS

CONTACT RATING: Dependent upon contact material, see page 29.

MECHANICAL LIFE: 30,000 make-and-break cycles.

CONTACT RESISTANCE: 20 mΩ max. (initial value) @ 2-4VDC
100mA for both silver and gold plated contacts.

INSULATION RESISTANCE: 1,000 MΩ min./1000VDC

DIELECTRIC STRENGTH: 1,000 Vrms min.@sea level.(initial value)

OPERATING TEMPERATURE: -40°C to 85°C.

MATERIALS

CASE: Diallyl phthalate (DAP) (UL94v-0).

ACTUATOR: Brass, chrome plated.

BUSHING: Brass or zinc, nickel plated.

HOUSING: Stainless Steel.

SWITCH SUPPORT: Brass, tin plated.

TERMINAL/CONTACT: Brass or copper with silver or gold plated.

(See page 29)

MODEL NO.	ACTUATOR	BUSHING	TERMINAL TYPE	TERMINAL PLATING	SEAL	RoHS SOLDERING
<u>SP</u>	<u>T1</u> 9.40 high	<u>B1</u> 5.59 high,flat (thd)		<u>Q</u> Silver	<u>E</u> EPOXY (std)	<u>S</u> RoHS & Lead Free
<u>2MS1</u> ON-NONE-ON	<u>T2</u> 5.33 high	<u>B2</u> 5.59 high,flat (non-thd)		<u>R</u> Gold	<u>N</u> NO EPOXY	
<u>2MS2</u> ON-NONE-(ON)	<u>T3</u> 7.37 high	<u>B3</u> 5.59 high,keyway (thd)		<u>C</u> Gold over silver		
<u>2MS3</u> ON-OFF-ON	<u>T4</u> 10.41 high	<u>B4</u> 5.59 high,keyway (non-thd)				
<u>2MS4</u> (ON)-OFF-(ON)	<u>T5</u> 5.59 high	<u>B5</u> 7.87 high,flat (thd)				
<u>2MS5</u> ON-OFF-(ON)	<u>TL1</u> 16.00 high	<u>B6</u> 7.87 high,flat (non-thd)				
<u>2MS6</u> OFF-NONE-ON	<u>TL2</u> 16.26 high	<u>B7</u> 6.60 high,keyway (thd)				
<u>DP</u>		<u>B8</u> 6.60 high,keyway (non-thd)				
<u>2MD1</u> ON-NONE-ON		<u>Locking</u>		<u>M1</u> Solder Lug		
<u>2MD2</u> ON-NONE-(ON)		<u>B25</u> 8.00 high,keyway, (thd) *		<u>M2</u> PC thru-hole		
<u>2MD3</u> ON-OFF-ON				<u>M51</u> 15.24 high, wire wrap		
<u>2MD6</u> ON-ON-ON ▲				<u>M6</u> Right angle, PC thru-hole **		
				<u>M6N</u> Right angle, snap-in, PC thru-hole **		
				<u>M7</u> Vertical right angle, PC thru-hole **		
				<u>M7N</u> Vertical right angle, snap-in, PC thru-hole **		
				<u>V-bracket</u>		
				<u>VS2</u> V-bracket		
				<u>V2N</u> Snap-in V-bracket		
				<u>VS3</u> V-bracket		
				<u>V3N</u> Snap-in V-bracket		

▲ Please confirm the availability before order.

* Only available for Locking lever.
** The terminal type of M6, M6N, M7, M7N are not suitable for 2MS6.

EXAMPLE: 2MS1T1B1M1QES

▼ SWITCH FUNCTION

NO. POLES	UL/CSA MODEL NO.	MODEL NO.	SWITCH FUNCTION			CONNECTED TERMINALS / SCHEMATIC		
			POS.1	POS.2	POS.3	POS.1	POS.2	POS.3
SP	Q2211	2MS1	ON	NONE	ON	2-3	N/A	2-1
	Q2212	2MS2	ON	NONE	(ON)			
	Q2213	2MS3	ON	OFF	ON		OPEN	
	Q2214	2MS4	(ON)	OFF	(ON)			
	Q2215	2MS5	ON	OFF	(ON)	OPEN	N/A	3-1
	Q2216	2MS6*	OFF	NONE	ON			
DP	Q2221	2MD1	ON	NONE	ON	2-3,5-6	N/A	2-1,5-4
	Q2222	2MD2	ON	NONE	(ON)			
	Q2223	2MD3	ON	OFF	ON		OPEN	
	▲ Q2226	2MD6	ON	ON	ON			

()=MOMENTARY

▲ Please confirm the availability before order.

▼ POLE OPTIONS

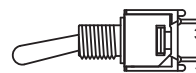
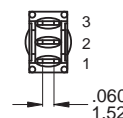
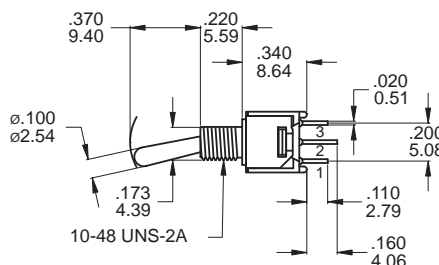
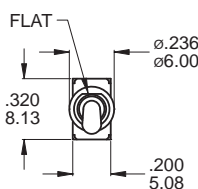

SPDT

Model name. 2MS1T1B1M1QES

* 2MS6 Models: Omit terminal 2

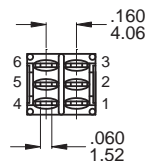
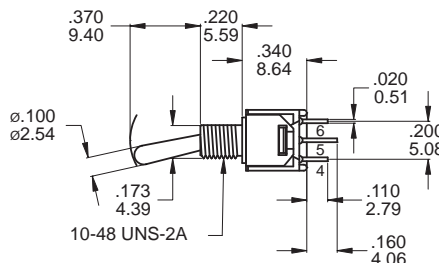
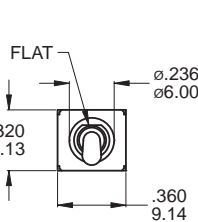

DPDT

Model name. 2MD1T1B1M1RES

2M Series

Sub-Miniature Toggle Switches



2M Toggle Switches

▼ ACTUATOR OPTIONS

T1

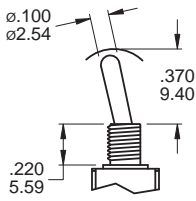

T2

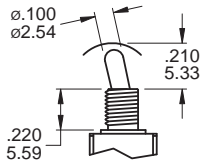

T3

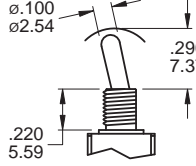

T4

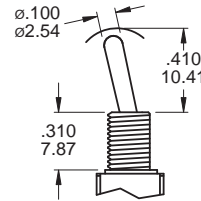

T5

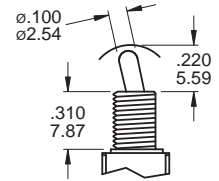

Note:

1. Above schematic T1, T2, T3 are shown with Bushing B1-B4.

For B5 Bushing: - .090inch(2.29mm)

For B7 Bushing: - .040inch(1.02mm)

2. T4, T5 Actuator are shown with Bushing B5, B6.

For B1-B3 Bushing: +.090inch(2.29mm)

For B7 Bushing: +.050inch(1.27mm)

3. T1~T5 Actuator are shown with Terminal M1 and M2.

For M6, M7, VSX: - .016inch(0.40mm)

TL1B25

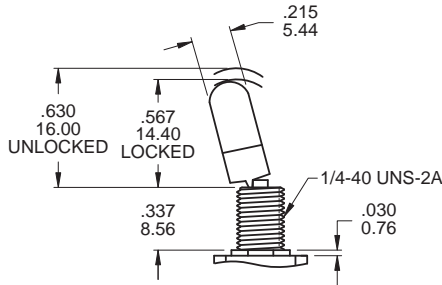

TL2B25

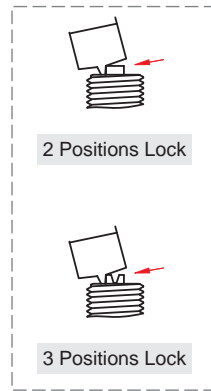
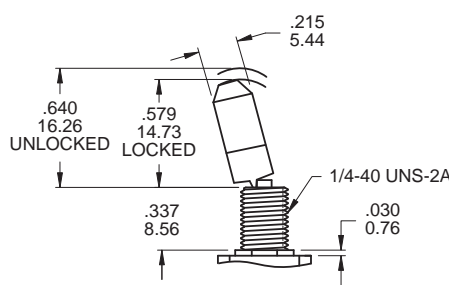

▼ BUSHING OPTIONS

B1 THD
B2 NON-THD

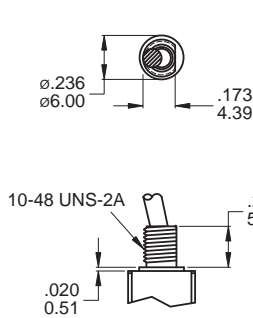

B3 THD
B4 NON-THD

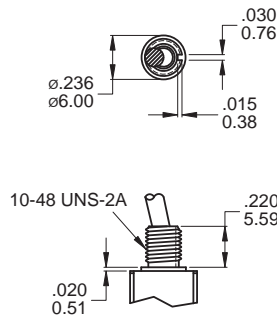

B5 THD
B6 NON-THD

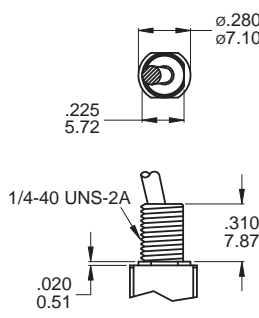

B7 THD
B8 NON-THD

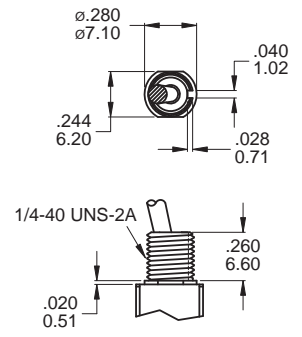

▼ PANEL MOUNTING

10-48 BUSHING

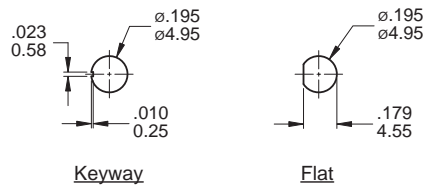

Keyway

Flat

Without locking ring

1/4 IN BUSHING

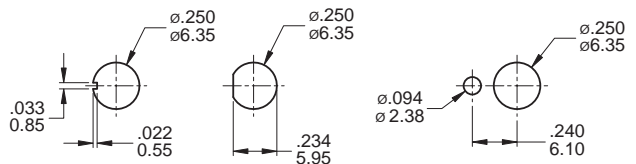

Keyway

Flat

Without locking ring

With standard locking ring

▼ TERMINAL OPTIONS

M1 Solder lug

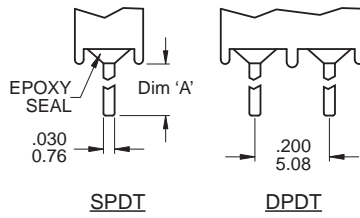
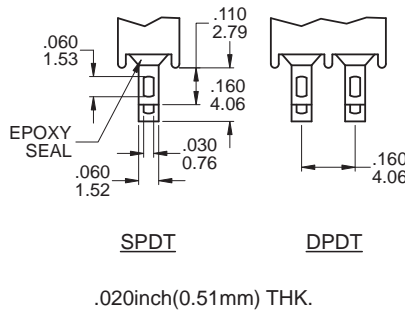

.020inch(0.51mm) THK.

TERMINAL	DIM. 'A'
M2 PC Thru-hole	.130 (3.30)
M51 Wire Wrap	.600 (15.24)

OTHER TERMINAL OPTIONS

- M6** Right angle P.C. Mount
- M6N** Right angle P.C. Mount Snap-in bracket
- M7** Vertical right angle P.C. Mount
- M7N** Vertical right angle P.C. Mount Snap-in bracket
- VS2-VS3** Vertical bracket P.C. Mount
- V2N-V3N** Vertical bracket P.C. Mount Snap-in bracket

M6 (M6N - Snap-in)

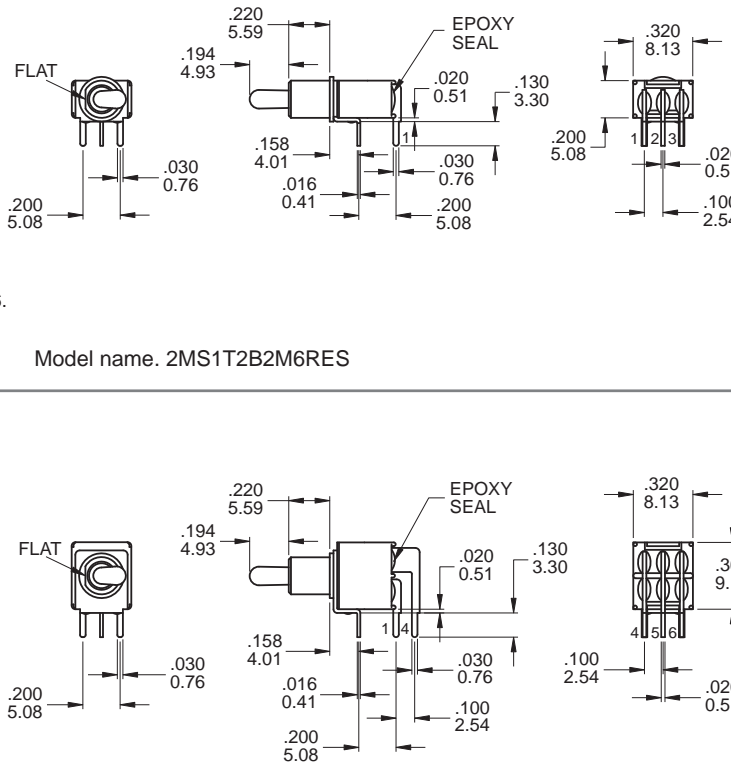

Note: Not available for 2MS6.

SPDT

Model name. 2MS1T2B2M6RES

M6

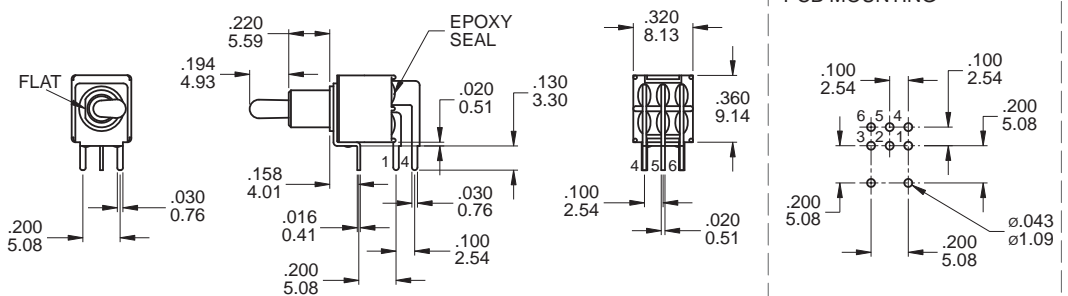

Note: Not available for 2MS6.

DPDT

Model name. 2MD1T2B2M6QES

M7 (M7N - Snap-in)

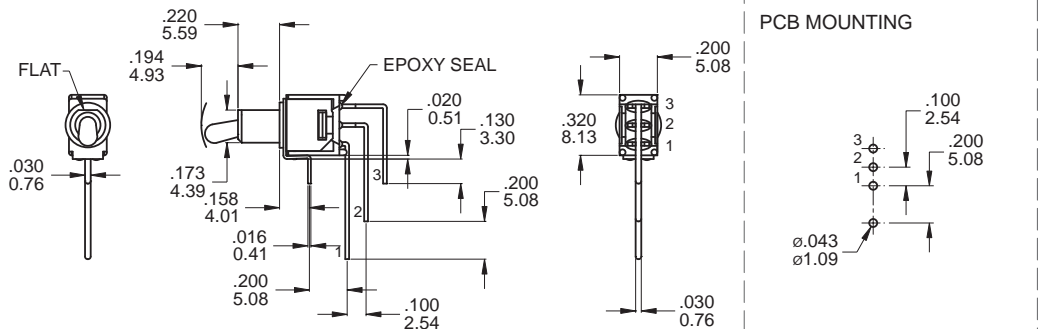

Note: Not available for 2MS6.

SPDT

Model name. 2MS1T2B2M7RES

2M Series

Sub-Miniature Toggle Switches



2M
Toggle Switches

M7 (M7N - Snap-in)

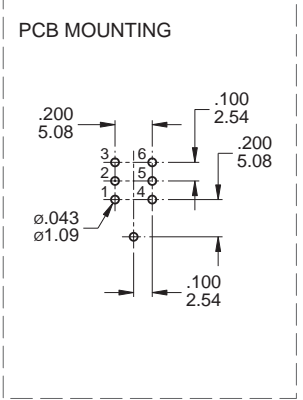
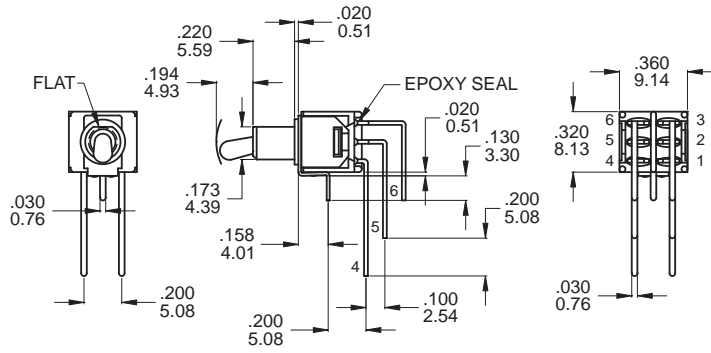
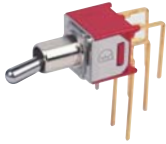

Note: Not available for 2MS6.

DPDT

Model name. 2MD1T2B2M7RES

VS2 / VS3

(V2N / V3N - Snap-in)

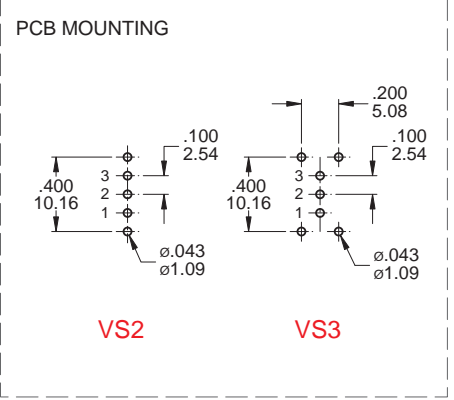
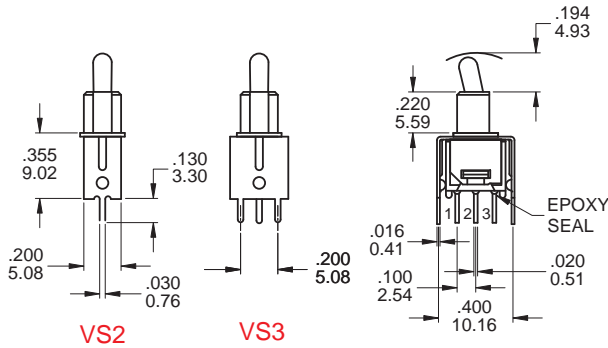

SPDT

Model name. 2MS1T2B2VS2QES

VS2 / VS3

(V2N / V3N - Snap-in)

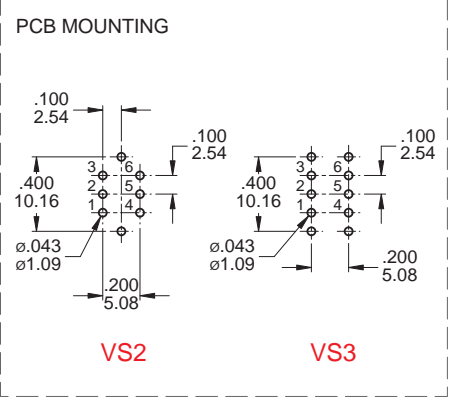
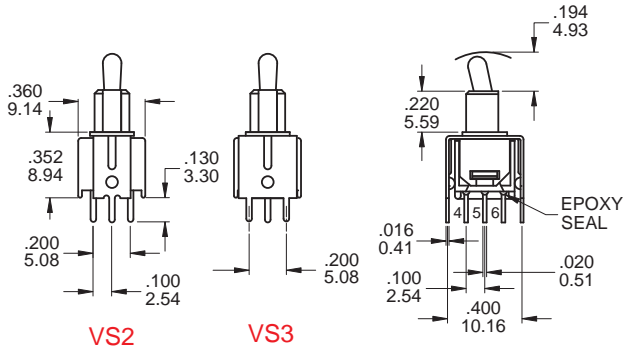

DPDT

Model name. 2MD1T2B2VS2QES

▼ SNAP-IN TERMINAL OPTIONS

M6N

M7N

V2N

V3N

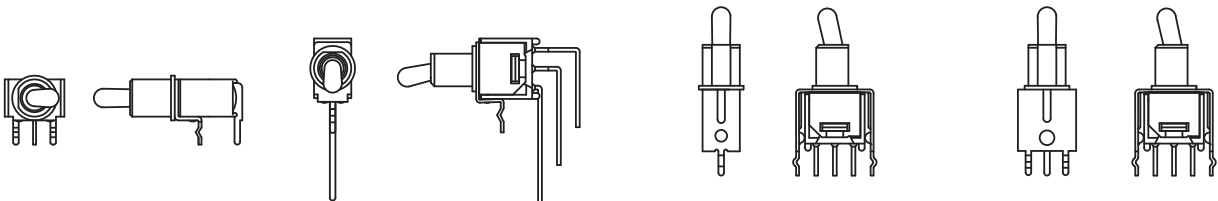

Note: The terminal type of M6N, M7N are not suitable for 2MS6.

▼ **HARDWARE**

EXAMPLE: - □
 Model name. 5 Standard hardware

* Standard Hardware: 10-48 Bushing: 2 nut, 1 lockwasher
 1/4-40 Bushing: 2 nut, 1 locking ring, 1 lockwasher

10-48 NUT (Std.)

Model name. MNU-2M01

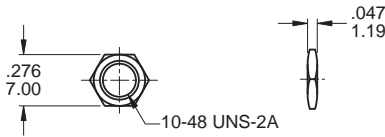

LOCKWASHER (Std.)

Model name. MNU-2M03

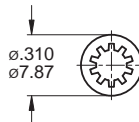

.018inch(0.46mm)THK

Available with bushing B1, B3 only.

LOCKWASHER (Std.)

Model name. MNU-1M03

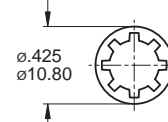

.018inch(0.46mm)THK

Available with bushing B5, B7 only.

1/4 NUT (Std.)

Model name. MNU--1M01A

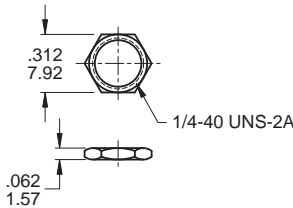

LOCKING RING (Std.)

Model name. MNU-1M02

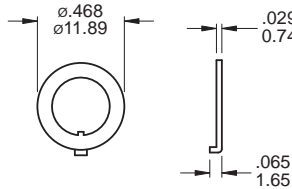

Available with bushing B7 only.

LOCKING RING (Std.)

Model name. MNU-1M11

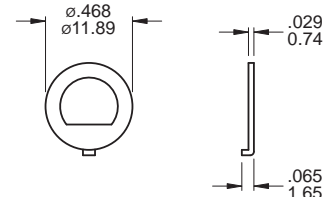

Available with bushing B5 only.

▼ **CONTACT & TERMINAL PLATING OPTIONS**

	CONTACT PLATING	TERMINAL PLATING	RATINGS
Q	Silver	Silver	3 Amps with resistant load @ 120VAC or 28VDC 1 Amps with resistant load @ 250VAC
C	Gold over Silver	Gold over silver	
R	Gold	Gold	0.4 Volt - Amps (VA) max. @ 20V max. (AC or DC)

▼ **SOLDERING PROCESS**

MANUAL SOLDERING: Use 30 watts soldering iron and controlled the temperature at 350°.

Duration of solder immersion: Max. 5 sec.

WAVE SOLDERING: Recommend soldering temperature: 260 ± 5°C

Duration of solder immersion: Max. 5 sec. (PCB thickness is 1.6mm)