

ZB4BK1253

Head for illuminated selector switch, Harmony XB4, metal, orange handle, 22mm, universal LED, 2 positions, stay put



Main

| | |
|-------------------------------|--------------------------------------|
| Range of product | Harmony XB4 |
| Product or component type | Head for illuminated selector switch |
| Product compatibility | Universal LED |
| Device short name | ZB4 |
| Bezel material | Chromium plated metal |
| Head type | Standard |
| Mounting diameter | 22 mm |
| Sale per indivisible quantity | 1 |
| Shape of signaling unit head | Round |
| Type of operator | Stay put |
| Operator profile | Orange standard handle |
| Operator position information | 2 positions 90° |

Complementary

| | |
|------------------------------------|--|
| CAD overall width | 29 mm |
| CAD overall height | 29 mm |
| CAD overall depth | 43 mm |
| Net weight | 0.036 kg |
| Resistance to high pressure washer | 7000000 Pa at 55 °C, distance : 0.1 m |
| Mechanical durability | 1000000 cycles |
| Electrical composition code | M3 for <4 contacts using single blocks in front mounting with integral LED M6 for <2 contacts using single blocks in front mounting with integral LED and transformer M10 for <2 contacts using single blocks in front mounting with integral LED M4 for <4 contacts using single and double blocks in front mounting with integral LED |
| Device presentation | Basic element |

Environment

| | |
|---------------------------------------|---|
| Protective treatment | TH |
| Ambient air temperature for storage | -40...70 °C |
| Ambient air temperature for operation | -40...70 °C |
| Overtoltage category | Class I conforming to IEC 60536 |
| IP degree of protection | IP66 conforming to IEC 60529 IP67 IP69 IP69K |
| NEMA degree of protection | NEMA 13 NEMA 4X |
| IK degree of protection | IK04 conforming to IEC 50102 |

The information provided in this documentation contains general descriptions and/or technical characteristics of the performance of the products contained herein. This documentation is not intended as a substitute for and is not to be used for determining suitability or reliability of these products for specific user applications. It is the duty of any such user or integrator to perform the appropriate and complete risk analysis, evaluation and testing of the products with respect to the relevant specific application or use thereof. Neither Schneider Electric Industries SAS nor any of its affiliates or subsidiaries shall be responsible or liable for misuse of the information contained herein.

| | |
|------------------------|--|
| Standards | CSA C22.2 No 14 JIS C8201-5-1 EN/IEC 60947-5-5 EN/IEC 60947-1 EN/IEC 60947-5-1 EN/IEC 60947-5-4 UL 508 JIS C8201-1 |
| Product certifications | UL listed[RETURN]GL[RETURN]DNV[RETURN]LROS (Lloyds register of shipping)[RETURN]BV[RETURN]CSA |
| Vibration resistance | 5 gn (f= 2...500 Hz) conforming to IEC 60068-2-6 |
| Shock resistance | 30 gn (duration = 18 ms) for half sine wave acceleration conforming to IEC 60068-2-27 50 gn (duration = 11 ms) for half sine wave acceleration conforming to IEC 60068-2-27 |

Packing Units

| | |
|------------------------------|-----------|
| Unit Type of Package 1 | PCE |
| Number of Units in Package 1 | 1 |
| Package 1 Height | 3.600 cm |
| Package 1 Width | 5.300 cm |
| Package 1 Length | 5.400 cm |
| Package 1 Weight | 41.000 g |
| Unit Type of Package 2 | S03 |
| Number of Units in Package 2 | 250 |
| Package 2 Height | 30.000 cm |
| Package 2 Width | 30.000 cm |
| Package 2 Length | 40.000 cm |
| Package 2 Weight | 10.830 kg |
| Unit Type of Package 3 | P06 |
| Number of Units in Package 3 | 2000 |
| Package 3 Height | 75.000 cm |
| Package 3 Width | 60.000 cm |
| Package 3 Length | 80.000 cm |
| Package 3 Weight | 96.604 kg |

Offer Sustainability

| | |
|----------------------------|--|
| Sustainable offer status | Green Premium product |
| REACH Regulation | REACH Declaration |
| REACH free of SVHC | Yes |
| EU RoHS Directive | Pro-active compliance (Product out of EU RoHS legal scope) EU RoHS Declaration |
| Toxic heavy metal free | Yes |
| Mercury free | Yes |
| China RoHS Regulation | China RoHS Declaration |
| RoHS exemption information | Yes |
| Environmental Disclosure | Product Environmental Profile |
| Circularity Profile | End Of Life Information |

Contractual warranty

| | |
|----------|-----------|
| Warranty | 18 months |
|----------|-----------|

Dimensions

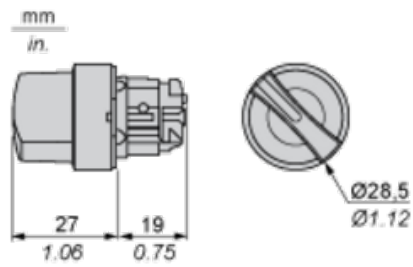

Panel Cut-out for Pushbuttons, Switches and Pilot Lights (Finished Holes, Ready for Installation)

| Connection by Screw Clamp Terminals or Plug-in Connectors or on Printed Circuit Board | Connection by Faston Connectors |
|---|---------------------------------|
| | |
| <p>(1) Diameter on finished panel or support (2) 40 mm min. / 1.57 in. min. (3) 30 mm min. / 1.18 in. min. (4) $\varnothing 22.5$ mm / 0.89 in. recommended ($\varnothing 22.3$ mm $_0^{+0.4}$ / 0.88 in. $_0^{+0.016}$) (5) 45 mm min. / 1.78 in. min. (6) 32 mm min. / 1.26 in. min.</p> | |

Pushbuttons, Switches and Pilot Lights for Printed Circuit Board Connection

Panel Cut-outs (Viewed from Installer's Side)



A: 30 mm min. / 1.18 in. min.
 B: 40 mm min. / 1.57 in. min.

Printed Circuit Board Cut-outs (Viewed from Electrical Block Side)

Dimensions in mm



A: 30 mm min.
 B: 40 mm min.
 Dimensions in in.



A: 1.18 in. min.
 B: 1.57 in. min.

General Tolerances of the Panel and Printed Circuit Board

The cumulative tolerance must not exceed 0.3 mm / 0.012 in: T1 + T2 = 0.3 mm max.

Installation Precautions

- Minimum thickness of circuit board: 1.6 mm / 0.06 in.
- Cut-out diameter: 22.4 mm \pm 0.1 / 0.88 in. \pm 0.004
- Orientation of body/fixing collar ZB4 BZ009: $\pm 2^\circ 30'$ (excluding cut-outs marked a and b).
- Tightening torque of screws ZBZ 006: 0.6 N.m (5.3 lbf.in) max.
- Allow for one ZB4 BZ079 fixing collar/pillar and its fixing screws:
 - every 90 mm / 3.54 in. horizontally (X), and 120 mm / 4.72 in. vertically (Y).
 - with each selector switch head (ZB4 BD•, ZB4 BJ•, ZB4 BG•).

The fixing centers marked a and b are diagonally opposed and must align with those marked 4 and 5.

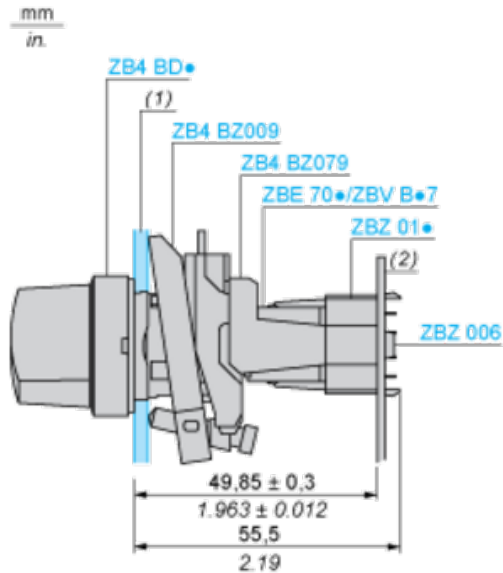

(1) Panel

(2) Printed circuit board

Mounting of Adapter (Socket) ZBZ 01•

- 1 2 elongated holes for ZBZ 006 screw access
- 2 1 hole \varnothing 2.4 mm \pm 0.05 / 0.09 in. \pm 0.002 for centring adapter ZBZ 01•
- 3 8 \times \varnothing 1.2 mm / 0.05 in. holes
- 4 1 hole \varnothing 2.9 mm \pm 0.05 / 0.11 in. \pm 0.002, for aligning the printed circuit board (with cut-out marked a)
- 5 1 elongated hole for aligning the printed circuit board (with cut-out marked b)
- 6 4 holes \varnothing 2.4 mm / 0.09 in. for clipping in adapter ZBZ 01•

Dimensions An + 18.1 relate to the \varnothing 2.4 mm \pm 0.05 / 0.09 in. \pm 0.002 holes for centring adapter ZBZ 01•.

Electrical Composition Corresponding to Code M3



Electrical Composition Corresponding to Code M4



Electrical Composition Corresponding to Codes M6 and P2



Electrical Composition Corresponding to Codes M5, M10, MF1, MR1 and MF2

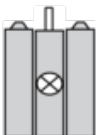

Legend

Single contact

Double contact

Light block





Possible location



Sequence of Contacts Fitted to 2-position Selector Switch Body

Position 315°



| | | | | | |
|----------|---|---|---|---|---|
| Push | Position | Top |  |  |  |
| Bottom |  |  | | | |
| Location | | Left | Right | | |
| State | | 0 | 0 | | |
| Contacts | N/O | | open | open | |
| N/C | | closed | closed | | |

Position 45°



| | | | | | |
|----------|--------------------------|--------------------------|--------|--|--|
| Push | Position | Top | |  | |
| Bottom | <input type="checkbox"/> | <input type="checkbox"/> | | | |
| Location | | Left | Right | | |
| State | | 1 | 1 | | |
| Contacts | N/O | | closed | closed | |
| N/C | | open | open | | |