

LED WATERTIGHT LUMINAIRE

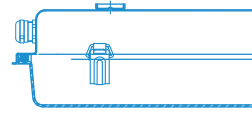

LWS SERIES

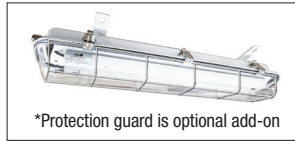

Application

Decks, Engine rooms, Yards, Coldrooms

Mounting Method

Surface mounted

Material

Diffuser: Polycarbonate
 Housing: SUS316 stainless steel or
 Zinc coated steel, Powder coated white
 Optional protection guard: SUS316 stainless steel

Electrical

Flexible wiring, Heat resistant up to 105°C

Options

100V ~ 120V AC
 220V ~ 240V AC

Weight

LWS21: 3.1Kg LWS22: 3.3Kg
 LWS41: 5.1Kg LWS42: 5.5Kg
 With 3Hr emergency backup battery: Add 0.18Kg

Key Features

- Triac dimming compatible
- Built-in with high thermal efficient linear module that allows lighting to operate at ambient temperature of up to 45°C
- Special designed clear polycarbonate diffuser to optimize the LED light transmission
- Long service life of 50,000 hours L70 @ 45°C (Ta)
- Safety, EMC and IEC compliance
- Available with battery backup system and emergency lighting



*For AC models only

LWS21/LWS22

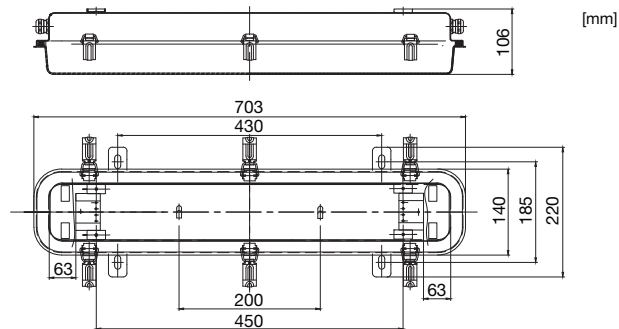
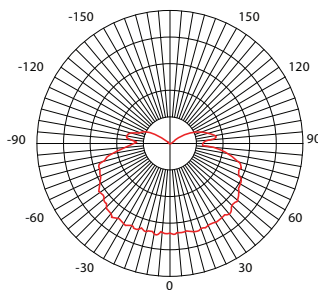

LWS41/LWS42

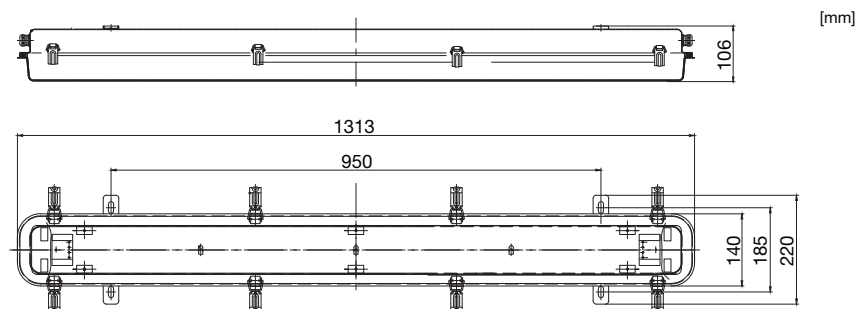
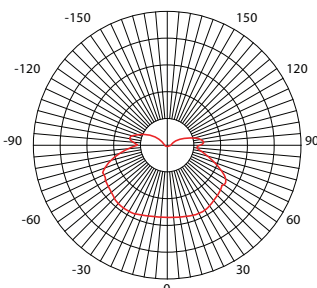

LED WATERTIGHT LUMINAIRE

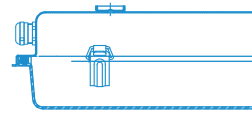

LWS SERIES

- S Denotes : Standard lighting
- B Denotes : With 3Hr battery backup
- E Denotes : With DC24V emergency LED

TECHNICAL SPECIFICATIONS



Ideal Replacement:

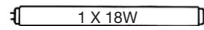

LWS21 for 1X18W

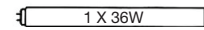

LWS41 for 1X36W

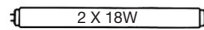

LWS22 for 2X18W

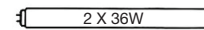

LWS42 for 2X36W

BH Code	Type	Main Voltage	Power	CCT	Ambient Temp (Ta)	System Lumen	Housing
LWS21SP5KA1S	LWS21-S	100V - 120V AC	1x12.5W	5000K	-30°C ~ +45°C	1150lm	SUS316 Stainless Steel
LWS21SP5KA1B	LWS21-SB	100V - 120V AC	1x12.5W	5000K	-30°C ~ +45°C	1150lm	SUS316 Stainless Steel
LWS21SP5KA1E	LWS21-SE	100V - 120V AC	1x12.5W	5000K	-30°C ~ +45°C	1150lm	SUS316 Stainless Steel
LWS21ZP5KA1S	LWS21-Z	100V - 120V AC	1x12.5W	5000K	-30°C ~ +45°C	1150lm	Zinc Coated Steel
LWS21ZP5KA1B	LWS21-ZB	100V - 120V AC	1x12.5W	5000K	-30°C ~ +45°C	1150lm	Zinc Coated Steel
LWS21ZP5KA1E	LWS21-ZE	100V - 120V AC	1x12.5W	5000K	-30°C ~ +45°C	1150lm	Zinc Coated Steel
LWS22SP5KA1S	LWS22-S	100V - 120V AC	2x12.5W	5000K	-30°C ~ +45°C	2300lm	SUS316 Stainless Steel
LWS22SP5KA1B	LWS22-SB	100V - 120V AC	2x12.5W	5000K	-30°C ~ +45°C	2300lm	SUS316 Stainless Steel
LWS22SP5KA1E	LWS22-SE	100V - 120V AC	2x12.5W	5000K	-30°C ~ +45°C	2300lm	SUS316 Stainless Steel
LWS22ZP5KA1S	LWS22-Z	100V - 120V AC	2x12.5W	5000K	-30°C ~ +45°C	2300lm	Zinc Coated Steel
LWS22ZP5KA1B	LWS22-ZB	100V - 120V AC	2x12.5W	5000K	-30°C ~ +45°C	2300lm	Zinc Coated Steel
LWS22ZP5KA1E	LWS22-ZE	100V - 120V AC	2x12.5W	5000K	-30°C ~ +45°C	2300lm	Zinc Coated Steel

Also available in other CCT.

*Ambient Temperature is not applicable for Battery Backup System and Emergency Lighting.

BH Code	Type	Main Voltage	Power	CCT	Ambient Temp (Ta)	System Lumen	Housing
LWS41SP5KA1S	LWS41-S	100V - 120V AC	1x24W	5000K	-30°C ~ +45°C	2200lm	SUS316 Stainless Steel
LWS41SP5KA1B	LWS41-SB	100V - 120V AC	1x24W	5000K	-30°C ~ +45°C	2200lm	SUS316 Stainless Steel
LWS41SP5KA1E	LWS41-SE	100V - 120V AC	1x24W	5000K	-30°C ~ +45°C	2200lm	SUS316 Stainless Steel
LWS41ZP5KA1S	LWS41-Z	100V - 120V AC	1x24W	5000K	-30°C ~ +45°C	2200lm	Zinc Coated Steel
LWS41ZP5KA1B	LWS41-ZB	100V - 120V AC	1x24W	5000K	-30°C ~ +45°C	2200lm	Zinc Coated Steel
LWS41ZP5KA1E	LWS41-ZE	100V - 120V AC	1x24W	5000K	-30°C ~ +45°C	2200lm	Zinc Coated Steel
LWS42SP5KA1S	LWS42-S	100V - 120V AC	2x24W	5000K	-30°C ~ +45°C	4400lm	SUS316 Stainless Steel
LWS42SP5KA1B	LWS42-SB	100V - 120V AC	2x24W	5000K	-30°C ~ +45°C	4400lm	SUS316 Stainless Steel
LWS42SP5KA1E	LWS42-SE	100V - 120V AC	2x24W	5000K	-30°C ~ +45°C	4400lm	SUS316 Stainless Steel
LWS42ZP5KA1S	LWS42-Z	100V - 120V AC	2x24W	5000K	-30°C ~ +45°C	4400lm	Zinc Coated Steel
LWS42ZP5KA1B	LWS42-ZB	100V - 120V AC	2x24W	5000K	-30°C ~ +45°C	4400lm	Zinc Coated Steel
LWS42ZP5KA1E	LWS42-ZE	100V - 120V AC	2x24W	5000K	-30°C ~ +45°C	4400lm	Zinc Coated Steel

Also available in other CCT.

*Ambient Temperature is not applicable for Battery Backup System and Emergency Lighting.

LED WATERTIGHT LUMINAIRE

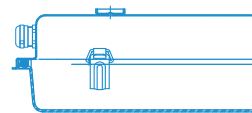

LWS SERIES

- S Denotes : Standard lighting
- B Denotes : With 3Hr battery backup
- E Denotes : With DC24V emergency LED

TECHNICAL SPECIFICATIONS



Ideal Replacement:

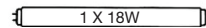

LWS21 for 1X18W

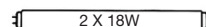

LWS22 for 2X18W

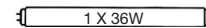

LWS41 for 1X36W

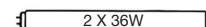

LWS42 for 2X36W

BH Code	Type	Main Voltage	Power	CCT	Ambient Temp (Ta)	System Lumen	Housing
LWS21SP5KA2S	LWS21-S	220V - 240V AC	1x12.5W	5000K	-30°C ~ +45°C	1150lm	SUS316 Stainless Steel
LWS21SP5KA2B	LWS21-SB	220V - 240V AC	1x12.5W	5000K	-30°C ~ +45°C	1150lm	SUS316 Stainless Steel
LWS21SP5KA2E	LWS21-SE	220V - 240V AC	1x12.5W	5000K	-30°C ~ +45°C	1150lm	SUS316 Stainless Steel
LWS21ZP5KA2S	LWS21-Z	220V - 240V AC	1x12.5W	5000K	-30°C ~ +45°C	1150lm	Zinc Coated Steel
LWS21ZP5KA2B	LWS21-ZB	220V - 240V AC	1x12.5W	5000K	-30°C ~ +45°C	1150lm	Zinc Coated Steel
LWS21ZP5KA2E	LWS21-ZE	220V - 240V AC	1x12.5W	5000K	-30°C ~ +45°C	1150lm	Zinc Coated Steel
LWS22SP5KA2S	LWS22-S	220V - 240V AC	2x12.5W	5000K	-30°C ~ +45°C	2300lm	SUS316 Stainless Steel
LWS22SP5KA2B	LWS22-SB	220V - 240V AC	2x12.5W	5000K	-30°C ~ +45°C	2300lm	SUS316 Stainless Steel
LWS22SP5KA2E	LWS22-SE	220V - 240V AC	2x12.5W	5000K	-30°C ~ +45°C	2300lm	SUS316 Stainless Steel
LWS22ZP5KA2S	LWS22-Z	220V - 240V AC	2x12.5W	5000K	-30°C ~ +45°C	2300lm	Zinc Coated Steel
LWS22ZP5KA2B	LWS22-ZB	220V - 240V AC	2x12.5W	5000K	-30°C ~ +45°C	2300lm	Zinc Coated Steel
LWS22ZP5KA2E	LWS22-ZE	220V - 240V AC	2x12.5W	5000K	-30°C ~ +45°C	2300lm	Zinc Coated Steel

Also available in other CCT.

*Ambient Temperature is not applicable for Battery Backup System and Emergency Lighting.

BH Code	Type	Main Voltage	Power	CCT	Ambient Temp (Ta)	System Lumen	Housing
LWS41SP5KA2S	LWS41-S	220V - 240V AC	1x24W	5000K	-30°C ~ +45°C	2200lm	SUS316 Stainless Steel
LWS41SP5KA2B	LWS41-SB	220V - 240V AC	1x24W	5000K	-30°C ~ +45°C	2200lm	SUS316 Stainless Steel
LWS41SP5KA2E	LWS41-SE	220V - 240V AC	1x24W	5000K	-30°C ~ +45°C	2200lm	SUS316 Stainless Steel
LWS41ZP5KA2S	LWS41-Z	220V - 240V AC	1x24W	5000K	-30°C ~ +45°C	2200lm	Zinc Coated Steel
LWS41ZP5KA2B	LWS41-ZB	220V - 240V AC	1x24W	5000K	-30°C ~ +45°C	2200lm	Zinc Coated Steel
LWS41ZP5KA2E	LWS41-ZE	220V - 240V AC	1x24W	5000K	-30°C ~ +45°C	2200lm	Zinc Coated Steel
LWS42SP5KA2S	LWS42-S	220V - 240V AC	2x24W	5000K	-30°C ~ +45°C	4400lm	SUS316 Stainless Steel
LWS42SP5KA2B	LWS42-SB	220V - 240V AC	2x24W	5000K	-30°C ~ +45°C	4400lm	SUS316 Stainless Steel
LWS42SP5KA2E	LWS42-SE	220V - 240V AC	2x24W	5000K	-30°C ~ +45°C	4400lm	SUS316 Stainless Steel
LWS42ZP5KA2S	LWS42-Z	220V - 240V AC	2x24W	5000K	-30°C ~ +45°C	4400lm	Zinc Coated Steel
LWS42ZP5KA2B	LWS42-ZB	220V - 240V AC	2x24W	5000K	-30°C ~ +45°C	4400lm	Zinc Coated Steel
LWS42ZP5KA2E	LWS42-ZE	220V - 240V AC	2x24W	5000K	-30°C ~ +45°C	4400lm	Zinc Coated Steel

Also available in other CCT.

*Ambient Temperature is not applicable for Battery Backup System and Emergency Lighting.