

Datasheet

RS PRO 5.0mm Pitch, 4 Ways, Right Angle Euro block Header, Slotted Screw

Stock No: 2378449, 2378450



Product Details:

RS PRO Series Euro Blocks are a broad range of PCB mounted terminal blocks in various sizes and profiles with pitches ranging from 15.00mm down to 3.50mm. Included are types that have wire entry from Top, Side or Side Angle. Two piece 'pluggable' versions and 'Lever Actuated' styles are also available. Each contains our unique wire guard design and is precision manufactured for smooth operation and ease of use.

Features & Benefits:

- Industry standard compatibility
- Dove tail design allows building multi-positions
- Captive screw with rising clamp design
- Euro blocks are supplied open screw "wire ready" position which shortens the time for connection.
- Available in many centerline pitch spacing.
- Available with optional high temperature insulator.
- Different color options available.

SPECIFICATION:

Material:

Insulator: PA66, rated UL 94V-0

Insulator color: Green

Cage: Brass, Nickel plated

Screw: Steel, M3.0/Zinc plated

Clamp: Phosphor Bronze, Nickel plated

Electrical:

Voltage rated: 300V

Current rated: 15A

Contact resistance: 20 mΩ

Insulation resistance: 500 MΩ @ 500 VDC

Withstanding voltage: 2000V AC/1 Min

Mechanical:

Solid wire: 28-14AWG 1.5mm²

Torque (Lb-In): 0.5Nm (4.5lb-in)

Strip length: 7-8mm

Temperature Rating:

-40°C to +105°C

Environmental:

Lead free, RoHS compliant.

Dimensional line drawings

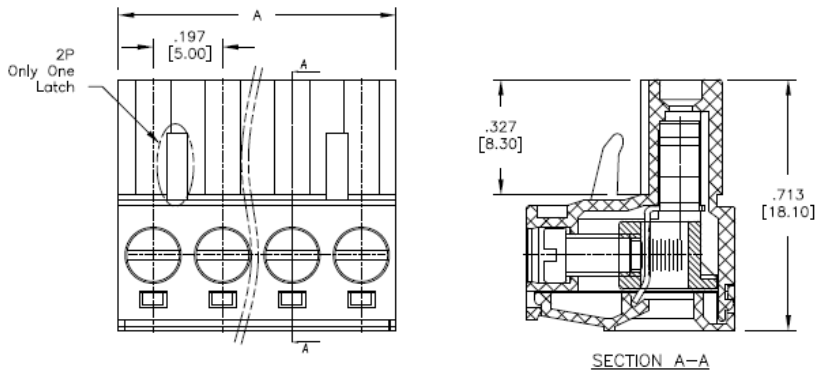

Poles: 2 thru 24

A= .197 [5.00] x No. of Poles

B= .197 [5.00] x No. of (Poles - 1)



rspro.com

