

Pin Headers

5.7mm, R/A, Single Row

multicomp PRO

**RoHS
Compliant**

Specifications

Current Rating	: 12 to 21A AC/DC
Voltage Rating	: 600V AC/DC
Contact Resistance	: 30mΩ Max.
Insulation Resistance	: 1000MΩ Min.
Withstand Voltage	: 600V AC /minute
Operating Temperature	: -40°C to +105°C

Materials

Insulator	: LCP (UL94V-0)
Colour	: Black
Contact	: High Performance Alloy
Plating	: Matte Tin

Diagram

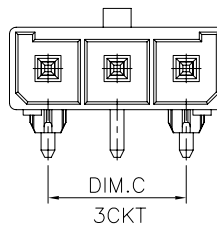
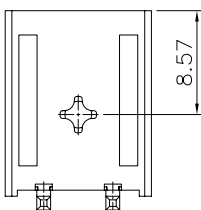
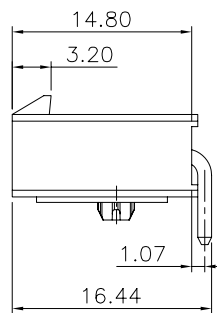
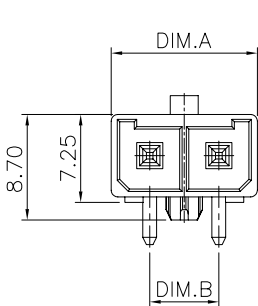
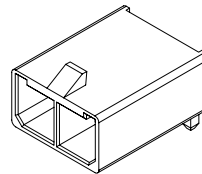
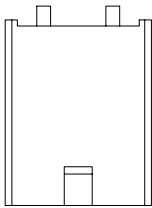

Circuits	Dimensions			
	A	B	C	D
2	12.05	5.7	--	13.5
3	17.75	11.4	11.4	18.75
4	23.45	17.1	17.1	24.45
5	29.15	22.8	22.8	30.15
6	34.85	28.5	28.5	35.85
7	40.55	34.2	34.2	41.55
8	46.25	39.9	39.9	47.25

Dimensions : Millimetres

Newark.com/multicomp-pro
Farnell.com/multicomp-pro
sg.element14.com/b/multicomp-pro

multicomp PRO

Pin Headers

5.7mm, R/A, Single Row

multicomp PRO

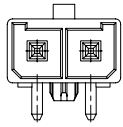

2CKT

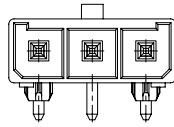

3CKT

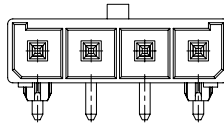

4CKT

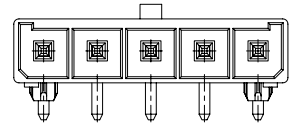

5CKT

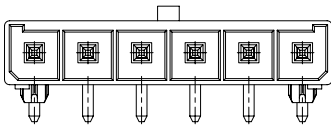

6CKT

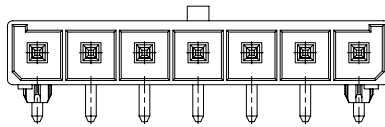

7CKT

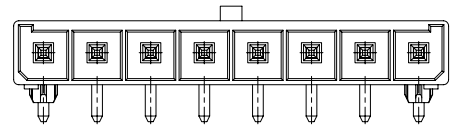

8CKT

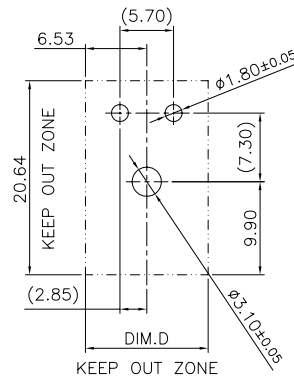
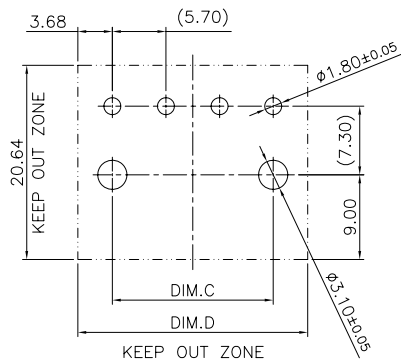

Part Number Table

Description	Part Number
Pin Header, 5.7mm, WTB, R/A, Single Row, 2 Way	MP010374
Pin Header, 5.7mm, WTB, R/A, Single Row, 3 Way	MP010375
Pin Header, 5.7mm, WTB, R/A, Single Row, 4 Way	MP010376
Pin Header, 5.7mm, WTB, R/A, Single Row, 5 Way	MP010377
Pin Header, 5.7mm, WTB, R/A, Single Row, 6 Way	MP010378
Pin Header, 5.7mm, WTB, R/A, Single Row, 7 Way	MP010379
Pin Header, 5.7mm, WTB, R/A, Single Row, 8 Way	MP010380

Important Notice : This data sheet and its contents (the "Information") belong to the members of the AVNET group of companies (the "Group") or are licensed to it. No licence is granted for the use of it other than for information purposes in connection with the products to which it relates. No licence of any intellectual property rights is granted. The Information is subject to change without notice and replaces all data sheets previously supplied. The Information supplied is believed to be accurate but the Group assumes no responsibility for its accuracy or completeness, any error in or omission from it or for any use made of it. Users of this data sheet should check for themselves the Information and the suitability of the products for their purpose and not make any assumptions based on information included or omitted. Liability for loss or damage resulting from any reliance on the Information or use of it (including liability resulting from negligence or where the Group was aware of the possibility of such loss or damage arising) is excluded. This will not operate to limit or restrict the Group's liability for death or personal injury resulting from its negligence. Multicomp Pro is the registered trademark of Premier Farnell Limited 2019.

Newark.com/multicomp-pro
 Farnell.com/multicomp-pro
 sg.element14.com/b/multicomp-pro

multicomp PRO