

---

ESTABLISHED & SONS  
United Kingdom  
Phone +44 (0)20 7608 0990  
establishedandsons.com

ESTANDSONS LTD  
Estandsons Warehouse  
Intereuropa d.d.  
Mednarodni prehod 8,  
SI-5290 Šempeter pri Gorici,  
Slovenija

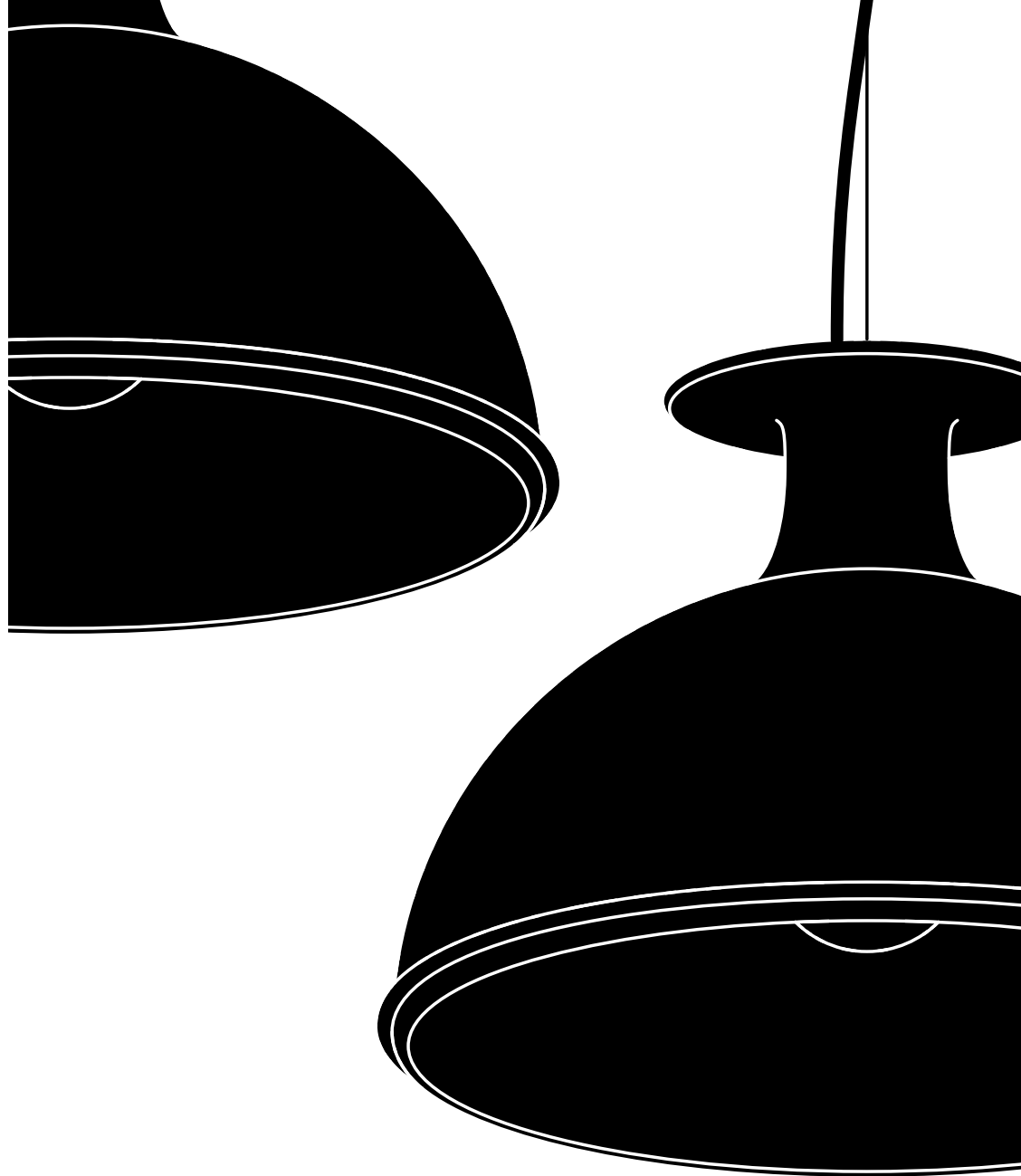

MARK LIGHT  
Martino Gamper

---

# MARK LIGHT

## Martino Gamper

---

A Venetian, mouth-blown glass suspension lamp accented with vibrant colours providing a diffused light. Designed by Martino Gamper and produced by traditional Murano glass-blowing techniques, the opal glass shade features colourful glass rings carefully applied by hand during the blowing process. The pendant light is finished with acrylic and steel fixings and a fabric cable, while an adjustable steel suspension wire with screw mounted fitting and positioning bar ensures the pendant balances evenly. This artisanal, handmade light was born from an original design created by Gamper for the Marksman restaurant in East London.

### THE DESIGNER

Martino Gamper lives and works in London. Starting as an apprentice with a furniture maker in Merano, Gamper went on to study sculpture under Michelangelo Pistoletto at the Academy of Fine Arts, Vienna. He completed a Masters in 2000 from the Royal College of Art, London, where he studied under Ron Arad. Working across design and art venues, Martino Gamper engages in a variety of projects from exhibition design, interior design, one-off commissions and the design of mass-produced products for the cutting edge of the international furniture industry. Gamper was awarded an OBE in 2023 for services to Design.



---

# General Information

---

IMPORTANT, RETAIN FOR FUTURE REFERENCE: READ CAREFULLY

---

DESIGN  
2023

DESCRIPTION  
Suspension Light

MATERIALS  
Mouth blown opal glass, powder coated steel, acrylic  
and steel fixings, fabric covered cable, steel suspension wire

DIMENSIONS  
S1 Ø300: Ø300mm × H215mm, cable L2000mm, 3.0kg

SUPPLY VOLTAGE  
120V, 60HZ

RECOMMENDED LIGHT SOURCE  
E26, max 9W LED, 110/120V

*This product is fitted with E26 LED bulb fittings. Established & Sons recommend using this product with LED bulbs, max 9W. Established & Sons will not accept any responsibility for any accidents, injuries or damages that occur due to the use of incorrect bulbs.*

CLEANING GUIDELINES  
For major maintenance or repairs, consult the retailer. ATTENTION! Ensure the electrical supply is switched off before cleaning. Clean electrical parts with a soft dry cloth only. To clean the glass use a slightly damp cloth with warm water, avoiding any abrasives or solvents.

USER INSTRUCTIONS  
This product is for indoor use only. Keep out of direct sunlight.  
Protect against exposure to heat above 60°C.  
Not recommended for continuous use over 16h.

---

## REQUIRED FOR INSTALLATION

---

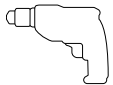

Combi Drill

2x Plugs

2x Screws

---

---

# Installation

---

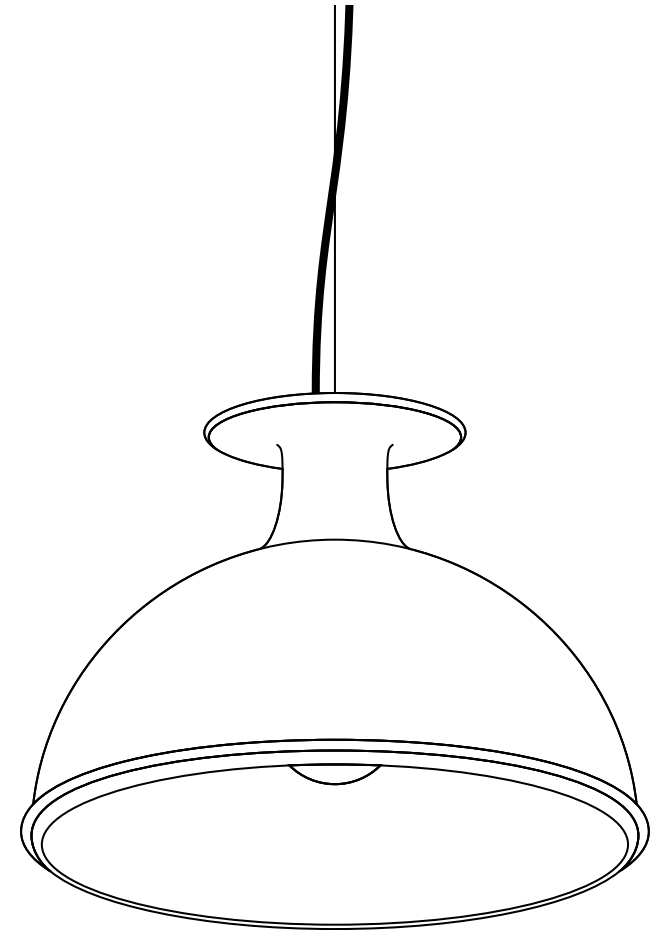

# Installation

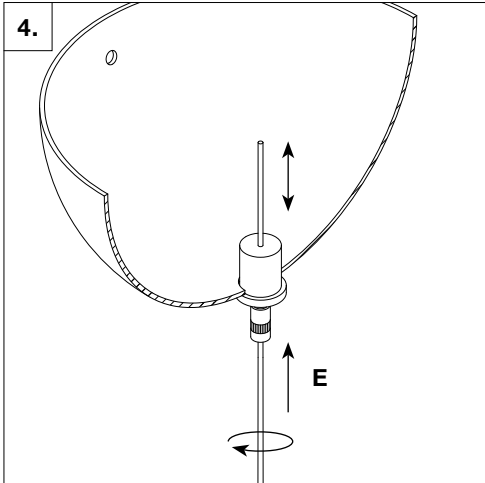
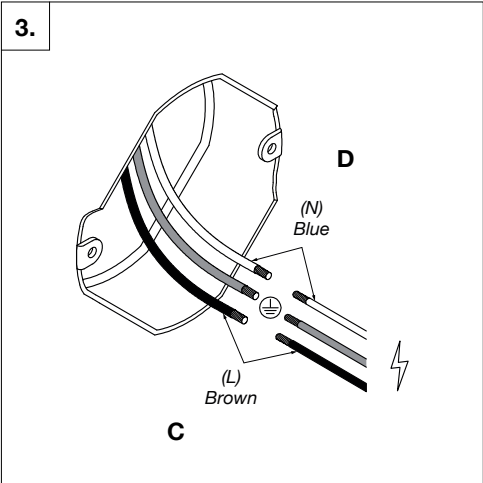
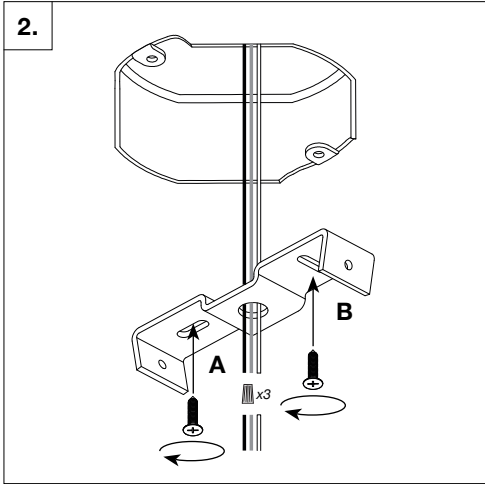
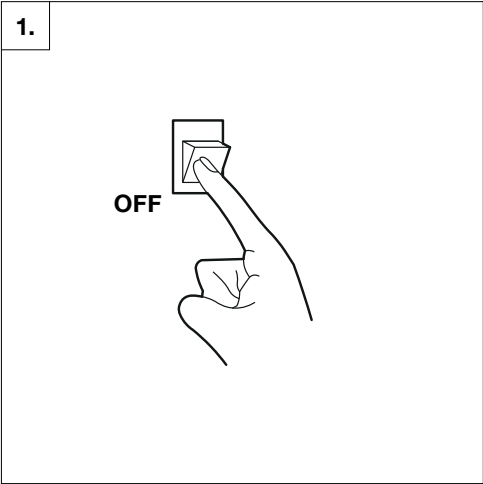

# Installation

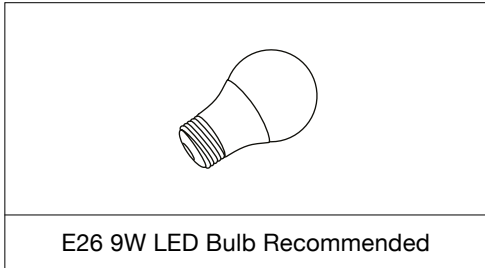
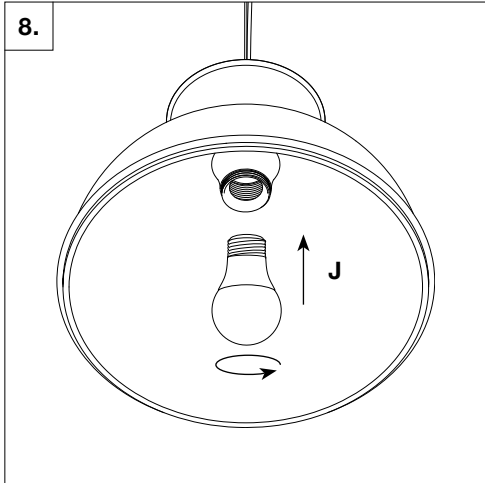
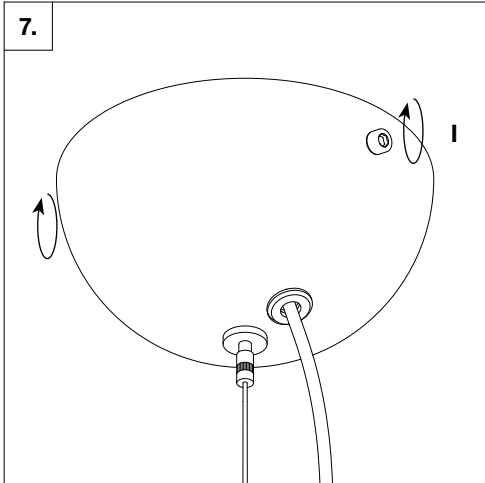
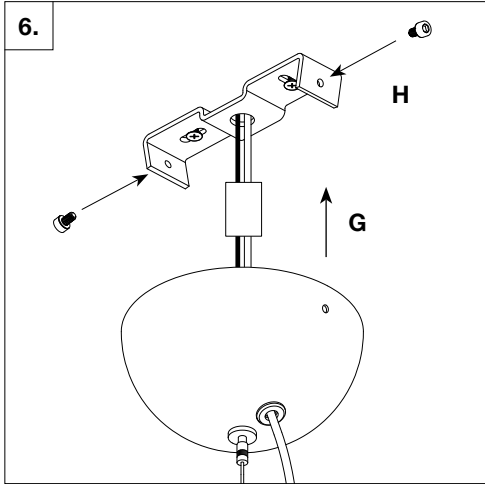
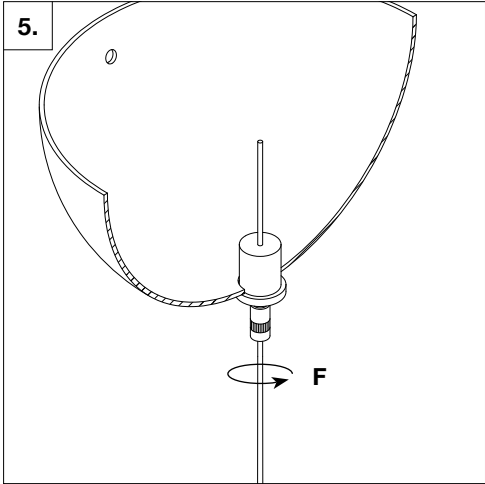

# Bulb Replacement

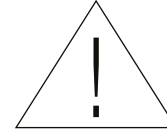
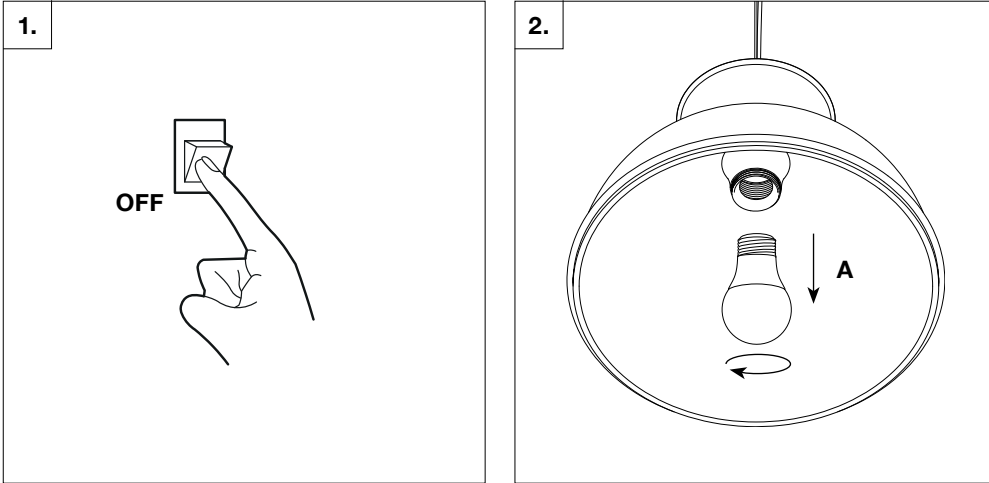

## <EN> INSTRUCTIONS FOR CORRECT INSTALLATION AND USE IMPORTANT!

Before installing and whenever acting on the luminaire ensure that the electrical supply is switched OFF. Always use a qualified electrician for the installation. Contact your local electricity authority for advice. Damaged electrical parts of the luminaire should be exclusively replaced by the manufacturer or a qualified person. E&S declines all responsibility for products that are modified.

## <ES> INSTRUCCIONES PARA EL USO Y LA INSTALACIÓN CORRECTOS ¡IMPORTANTE!

Antes de instalarla y siempre que manipule la luminaria, asegúrese de que el suministro eléctrico esté APAGADO. Recurra siempre a un electricista cualificado para la instalación. Póngase en contacto con su compañía local de electricidad para solicitar información. Las piezas eléctricas averiadas de la luminaria solo deben ser reemplazadas por el fabricante o por una persona cualificada. E&S declina toda responsabilidad por los productos que hayan sido modificados.

## <IT> ISTRUZIONI PER UN CORRETTO MONTAGGIO ED USO IMPORTANTE!

Prima di installare ed ogni volta che si interviene sull'apparecchio assicurarsi che la tensione di alimentazione sia SPENTA. Per il montaggio rivolgersi sempre ad un elettricista qualificato. Contattare l'ente locale competente per qualunque suggerimento. Le parti elettriche danneggiate devono essere sostituite esclusivamente dal costruttore o da una persona qualificata. E&S declina da ogni responsabilità per prodotti che sono stati modificati.

## <DE> INSTALLATIONS- WARTUNGS- UND BEDIENUNGSHINWEISE ACHTUNG!

Licht vor Installation, Wartung und Reinigung immer von der Stromversorgung trennen. Installation sollte immer durch eine Fachkraft ausgeführt werden. Bei Fragen kontaktieren Sie Ihren Stromversorger oder einen Elektrofachbetrieb. Beschädigte Komponenten sollten nur durch den Hersteller oder durch eine Fachkraft ausgetauscht werden. E&S ist nicht haftbar fuer Produkte, die in irgendeiner Form modifiziert wurden.

## <FR> MODE D'EMPLOI POUR UNE BONNE INSTALLATION ET UTILISATION IMPORTANT!

Avant l'installation et chaque fois que vous manipulez le luminaire assurez-vous que l'alimentation électrique est COUPÉE. Appelez toujours un électricien qualifié pour l'installation. Prenez conseil auprès de votre autorité d'électricité locale. Les pièces électriques endommagées du luminaire doivent être remplacées exclusivement par le fabricant ou une personne qualifiée. E&S décline toute responsabilité pour les produits modifiés.

## <PT> INSTRUÇÕES PARA A CORRETA INSTALAÇÃO E UTILIZAÇÃO IMPORTANTE!

Antes de instalar e sempre que atuar sobre o candeeiro deve confirmar que a alimentação elétrica DESLIGADA. A instalação deve ser sempre feita por um electricista qualificado. Contacte a sua entidade local de electricidade para aconselhamento. As componentes elétricas danificadas do candeeiro devem ser substituídas apenas pelo fabricante ou por uma pessoa qualificada. A E&S declina qualquer responsabilidade em relação a produtos que sejam alterados.

## <AR> تعليمات التركيب والاستعمال بالطريقة الصحيحة هام!

قبل التركيب وقيل الشروع بأي إجراء على المصباح، تأكد من أن التيار الكهربائي مُطفأ. ينبغي أن يتم التركيب على يد فني كهرباء مختص ومؤهل. اتصل بسلطة الكهرباء المحلية للحصول على النصائح. ينبغي عدم استبدال القطع الكهربائية المتضررة داخل المصباح إلا بواسطة الشركة المصنعة أو شخص مؤهل. لا تتحمل E&S أي مسؤولية عن المنتجات التي يتم تعديلها.



---

# About Established & Sons

---

Established & Sons is a British brand representing all that is innovative in contemporary design. By supporting the best creators of our time, it has built a collection for people who are passionate about design, presenting imaginative products with style and personality.

Designers and artists are afforded the freedom to explore their own language, advancing pioneering ideas that deliver exceptional furniture and lighting collections. Combined with Established & Sons' commitment to skilled craftsmanship and cutting-edge manufacturing techniques, this produces intelligent designs that are at the same time diverse in the extreme and united in their quest for the extraordinary.

The Established & Sons collection includes some of the most important examples of 21st-century design. Many of the pieces have been acquired by international museums, galleries, institutions and private collections.

Follow us on Instagram

