

FEATURES

- Trimmed 1% Bandgap Reference
- Nominal Temperature Range Extended to 105°C
- Temperature-Compensated: 30ppm/°C
- Internal Amplifier with 150mA Capability
- Low Output Noise
- Low Frequency Dynamic Output Impedance

DESCRIPTION

The TL431 is an adjustable shunt regulator designed to act as an open-loop error amplifier with a 2.5V temperature compensated reference. Its highly accurate 1% bandgap reference is perfect for applications requiring stability and accuracy over temperature and life.

Sharp turn-on characteristics and a low temperature coefficient make the TL431 an excellent replacement for many zener diode applications, programmable to any value greater than 2.5V and up to 36V by using two external resistors. As a combination error amplifier and reference, it can be used to manage control loops such as switching power supplies.

ORDERING INFORMATION

Part	Package	Temperature Range
TL431LP	TO-92	0 to 105°C
TL431D	8-Pin Plastic SOIC	0 to 105°C
TL431S	SOT-89	0 to 105°C

PIN CONFIGURATION (Top View)

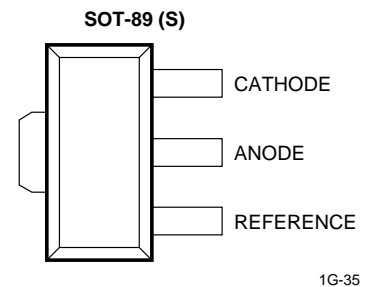
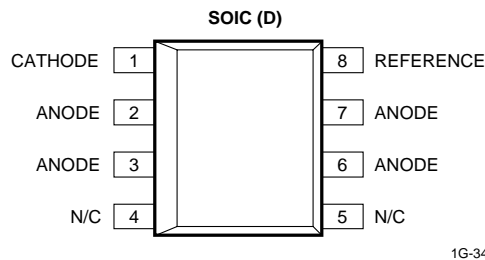
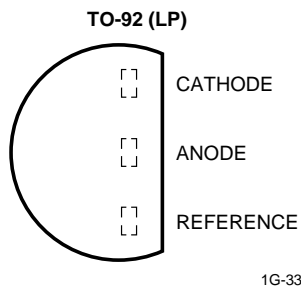

ABSOLUTE MAXIMUM RATINGS

SYMBOL	PARAMETER	RATING	UNITS
V _{KA}	Cathode-Anode Reverse Breakdown	37	V
I _{AK}	Anode-Cathode Forward Current	1	A
I _{KA}	Operating Cathode Current	250	mA
I _{REF}	Reference Input Current	10	mA
P _D	Continuous Power at 25°C TO-92 8L SOIC SOT-89	775 750 1000	mW mW mW
T _J	Junction Temperature	150	°C
T _{STG}	Storage Temperature	-65 to 150	°C
T _L	Lead Temperature, Soldering 10 Seconds	300	°C

Stresses greater than those listed under ABSOLUTE MAXIMUM RATINGS may cause permanent damage to the device. This is a stress rating only and functional operation of the device at these or any other conditions above those indicated in the operational sections of this specification is not implied. Exposure to absolute maximum rating conditions for extended periods may affect reliability.

RECOMMENDED CONDITIONS

SYMBOL	PARAMETER	RATING	UNIT
V _{KA}	Cathode Voltage	V _{REF} to 20	V
I _K	Cathode Current	10	mA

TYPICAL THERMAL RESISTANCE

PACKAGE	θ _{JA}	θ _{JC}	TYPICAL DERATING
TO-92	160°C/W	80°C/W	6.3mW/°C
SOIC	175°C/W	45°C/W	5.7mW/°C
SOT-89	110°C/W	8°C/W	9.1mW/°C

FUNCTIONAL BLOCK DIAGRAM

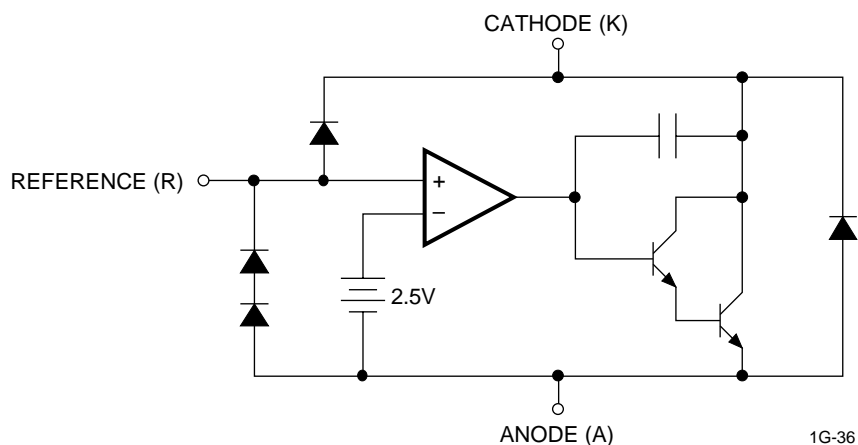

ELECTRICAL CHARACTERISTICS

Electrical Characteristics are guaranteed over full junction temperature range (0 to 105°C). Ambient temperature must be derated based on power dissipation and package thermal characteristics. The conditions are: $V_{KA} = V_{REF}$ and $I_K = 10\text{mA}$ unless otherwise stated.

SYMBOL	PARAMETER	MIN	TYP	MAX	UNIT	TEST CIRCUIT	TEST CONDITION
V_{REF}	Reference Voltage	2.470	2.495	2.520	V	1	$T_A = 25^\circ\text{C}$
		2.449		2.541	V	1	Over Temp.
TC	ΔV_{REF} with Temp.*		0.07	0.20	mV/°C	1	
$\frac{\Delta V_{REF}}{\Delta V_K}$	Ratio of Change in V_{REF} to Cathode Voltage	-2.7	-1.0		mV/V	2	V_{REF} to 10V
		-2	-0.4	0.3			10V to 36V
I_{REF}	Reference Input Current		0.7	4	μA	2	
ΔI_{REF}	I_{REF} Temp Deviation		0.4	1.2	μA	2	Over Temp.
$I_{K(MIN)}$	Min I_K for Regulation		0.4	1	mA	1	
$I_{K(OFF)}$	Off State Leakage		0.04	250	nA	3	$V_{REF} = 0\text{V}$, $V_{KA} = 36\text{V}$
Z_{KA}	Dynamic Output Impedance		0.15	0.5	Ω	1	$f \leq 1\text{kHz}$, $I_K = 1$ to 150mA

***CALCULATING AVERAGE TEMPERATURE COEFFICIENT (TC)**

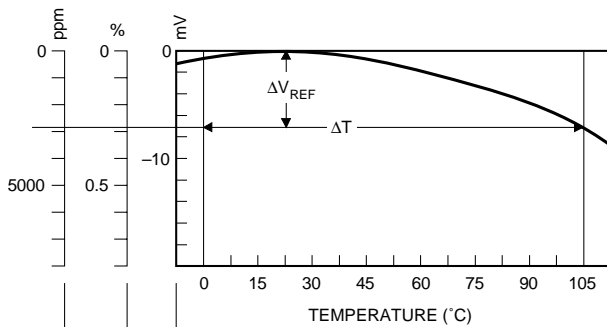

- 0.07 mV/°C
- 0.003 %/°C
- 27 ppm/°C

1G-37

• $TC \text{ in mV}/^\circ\text{C} = \frac{\Delta V_{REF} \text{ (mV)}}{\Delta T_A}$

• $TC \text{ in } \%/^\circ\text{C} = \frac{\left(\frac{\Delta V_{REF}}{V_{REF} \text{ at } 25^\circ\text{C}} \right) \times 100}{\Delta T_A}$

• $TC \text{ in ppm}/^\circ\text{C} = \frac{\left(\frac{\Delta V_{REF}}{V_{REF} \text{ at } 25^\circ\text{C}} \right) \times 10^6}{\Delta T_A}$

TEST CIRCUITS

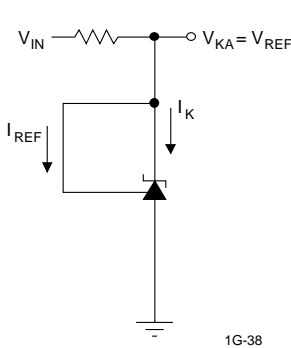

1G-38

TEST CIRCUIT 1

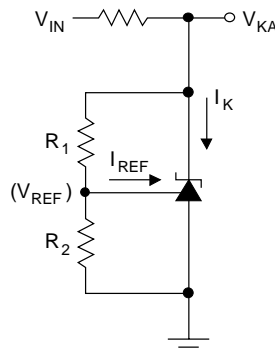

1G-39

TEST CIRCUIT 2

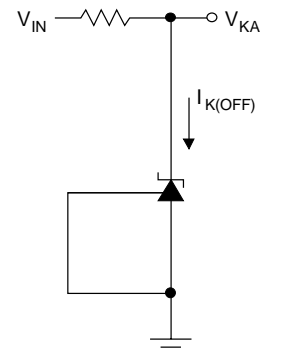

1G-40

TEST CIRCUIT 3

TYPICAL PERFORMANCE CURVES

LOW CURRENT OPERATING CHARACTERISTICS

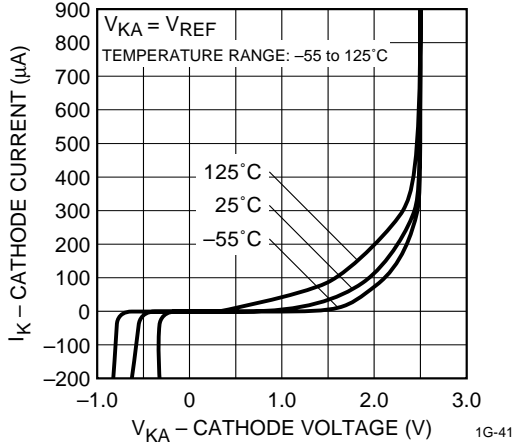

HIGH CURRENT OPERATING CHARACTERISTICS

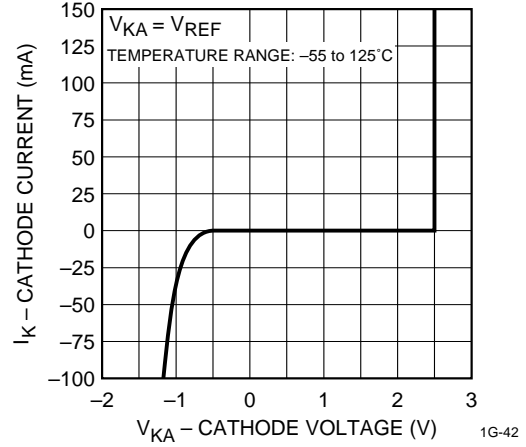

OFF STATE LEAKAGE

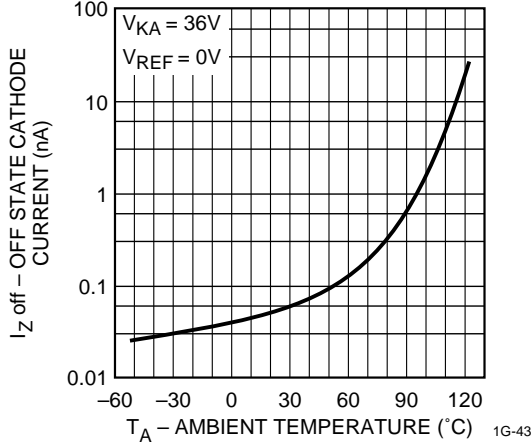

TEMPERATURE COEFFICIENT AS A FUNCTION OF TRIM VALUE

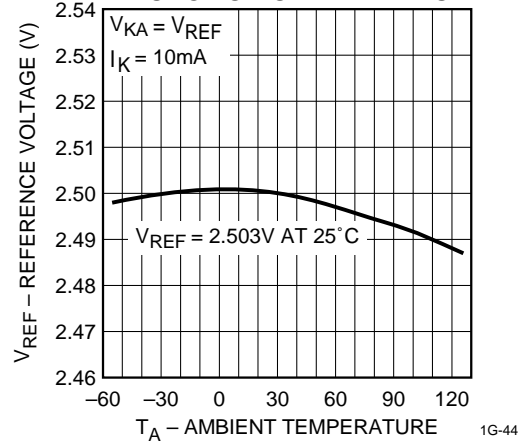

REFERENCE INPUT CURRENT

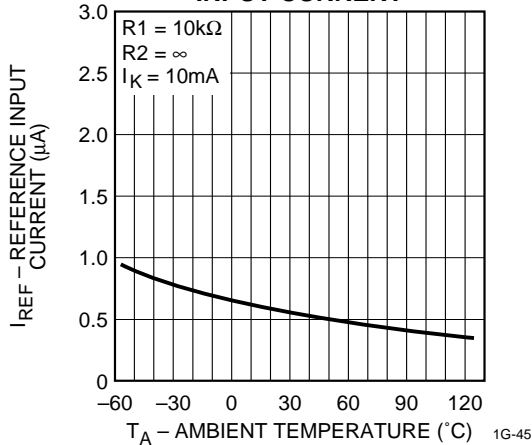

REFERENCE VOLTAGE LINE REGULATION

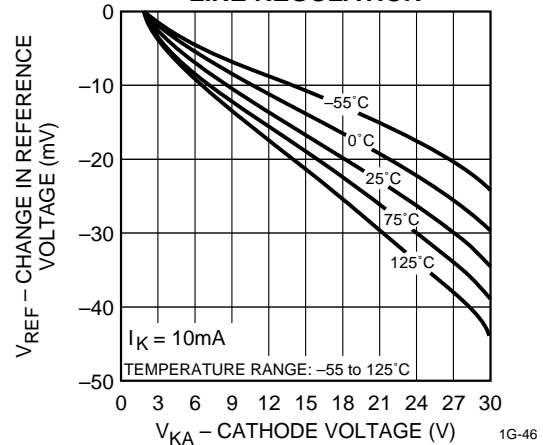

TYPICAL PERFORMANCE CURVES (continued)

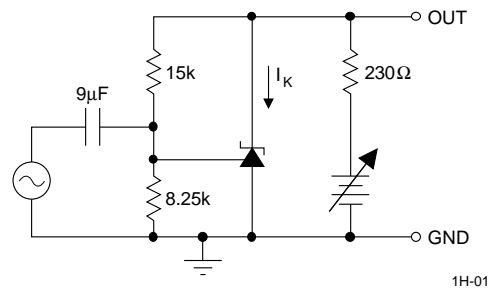
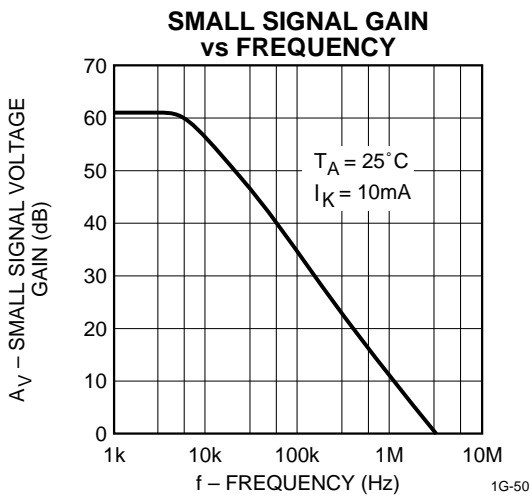
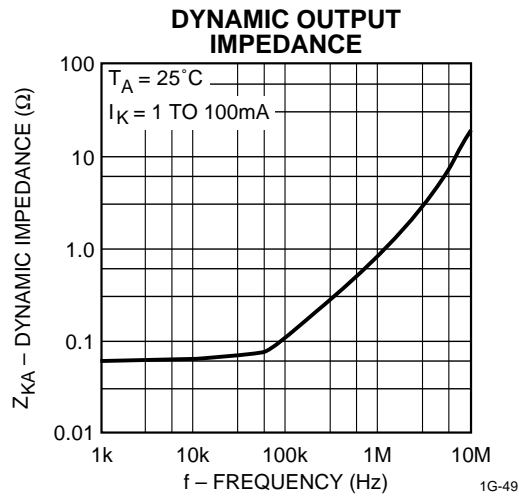
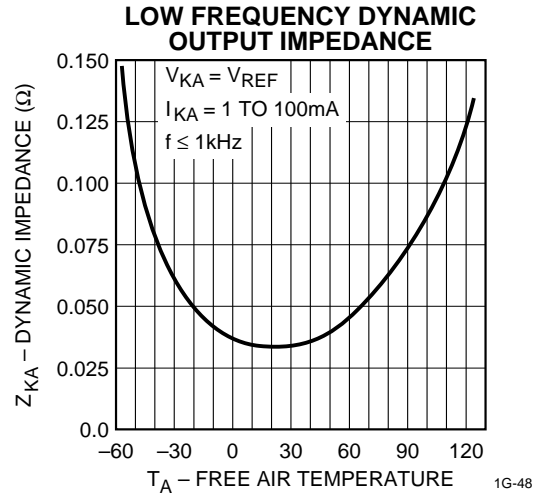
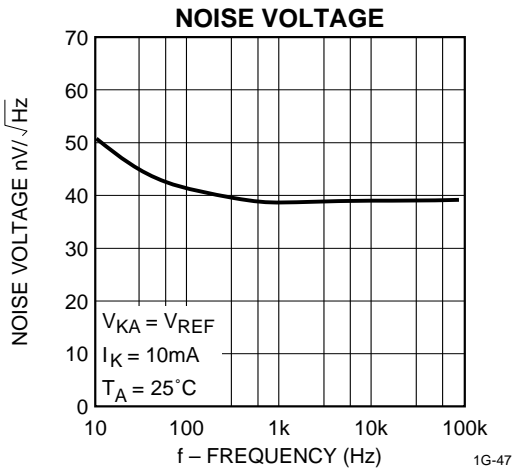

TYPICAL PERFORMANCE CURVES (continued)

