



ARCHON 110

Passive Sound Reinforcement

APPLICATIONS

- Bars
- Pubs
- Restaurants
- Retail shops
- Clubs
- Entertainment venues
- Fitness centres
- Conference rooms
- Theatres
- Houses of worship
- Exhibition centres

KEY FEATURES

- 2-way passive sound reinforcement system
- 0.59" baltic birch plywood cabinet
- 1 x 10" custom custom designed high excursion LF woofer
- 1 x 1" custom designed HF compression driver
- Rotatable horn
- 350W continuous pink noise
- 700W continuous program
- 1400W peak
- Full-range / Bi-amp crossover networks with protection
- Optional line transformer (200W)
- 12 x M10 threaded rigging points
- 1x4 Euroblock terminal speaker connector / 2 x Neutrik NL-4 speakon
- Choice of different RAL paint colours
- Choice of different paint finish
- Completely manufactured in Italy



Designed, Engineered
and Manufactured in ITALY

PRODUCT DESCRIPTION

The loudspeaker shall consist of a 10" low frequency transducer, 1" HF dome tweeter; the low frequency driver's voice coil shall be 2.5" in diameter. The loudspeaker shall be setup in full-range mode or bi-amp mode. Performance specifications of a typical unit shall be as follows: usable frequency response shall extend from 60Hz to 18kHz; nominal impedance shall be 8 ohms; the frequency dividing network shall have a crossover frequency of 1.8kHz; measured sensitivity shall be at least 97dB (at 1m [3.3ft]). The input shall be switchable for use either at nominal 8 ohms or on a 100V distributed speaker line via transformer (optional). The HF driver shall be horn loaded to cover 80 degrees horizontal by 50 degrees vertical (rotatable horn). The cabinet shall be constructed of 0.59" Baltic birch plywood covered in a scratch & scuff resistant black or white finish. The enclosure shall be fitted with threaded inserts to allow for a variety of mounting methods.

ELECTRONIC SPECIFICATIONS

System Type	2 Way
Recommended Amplifier	700W RMS
System Long Term Power	350W
System Short Term Power (IEC 268-5)	1400W
Transformer (optional)	100V / 200W
Nominal Impedance	8 Ohm
Frequency Response	60Hz - 18kHz (@-6dB)
Sensitivity	97dB (@1W, 1m)
Max SPL (cont/peak) (bi-amp)*	125dB / 129dB
Dispersion	80° H x 50° V
Crossover Frequency	1.8kHz
Recommended HP Filter	45Hz - 24dB oct.

PHYSICAL SPECIFICATIONS

Low Frequency Woofer	10" / 2.5" coil
High Frequency Driver	1" / 1.7" coil
Input Connectors	Euroblock (4 pin) / 2 x Speakon
Net Dimensions (WxHxD) inch	12.59 x 21.65 x 12.79
Shipping Dimensions (WxHxD) inch	16.53 x 25.59 x 16.53
Net Weight	33lbs
Shipping Weight	37.4lbs
Enclosure Material	0.59" baltic plywood
Grille	Steel with powder coat black or white paint finish

* CONT. SPL: free space, based on recommended amp rating and LF transducer average sensitivity data, 125mS time average
PEAK SPL: free space, based on short term applicable power rating and system peak sensitivity, 10mS time average



DIAGRAMS

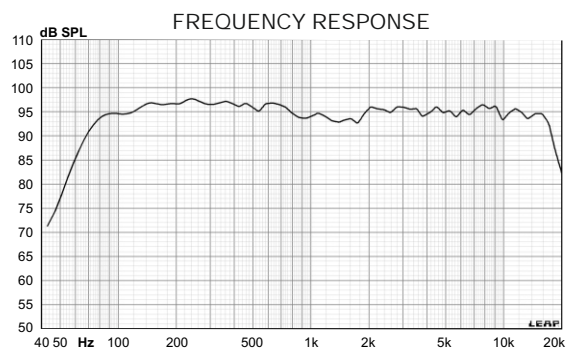
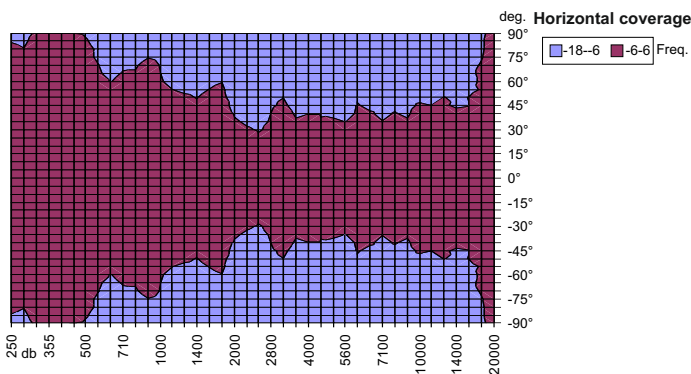
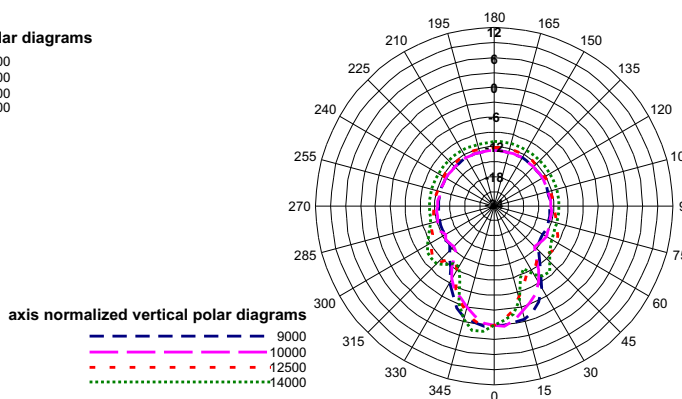
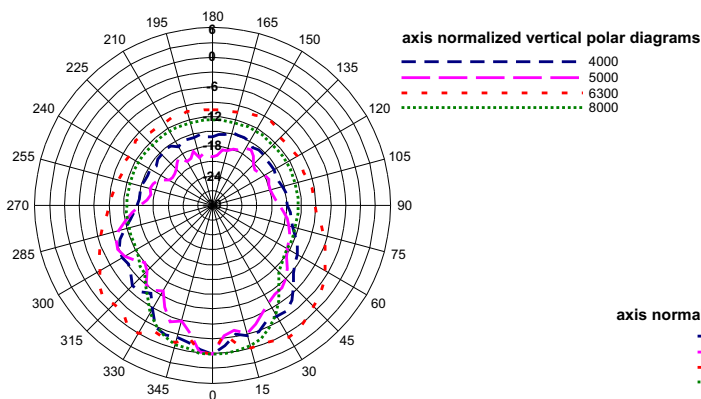
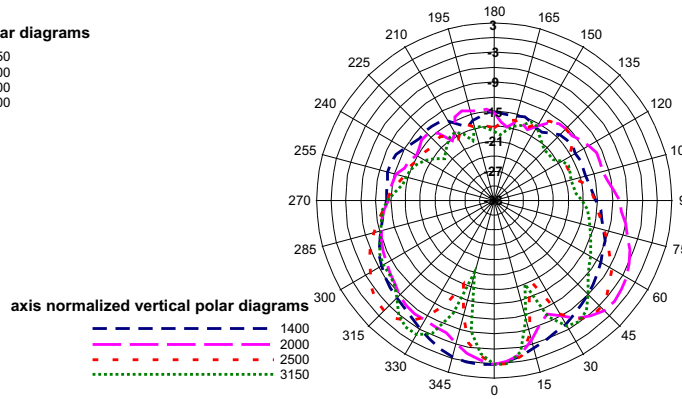
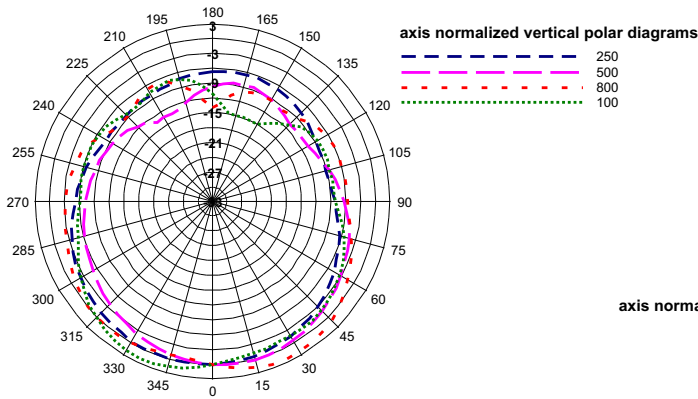
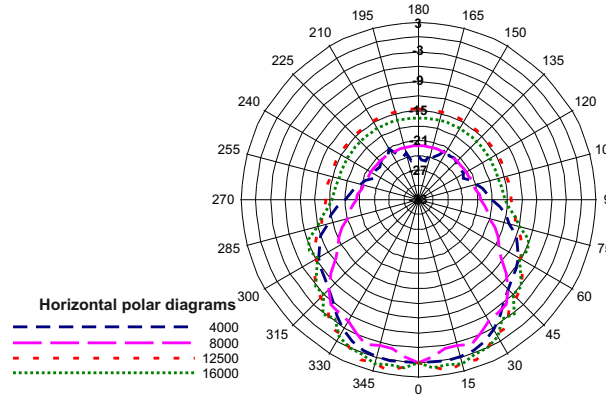
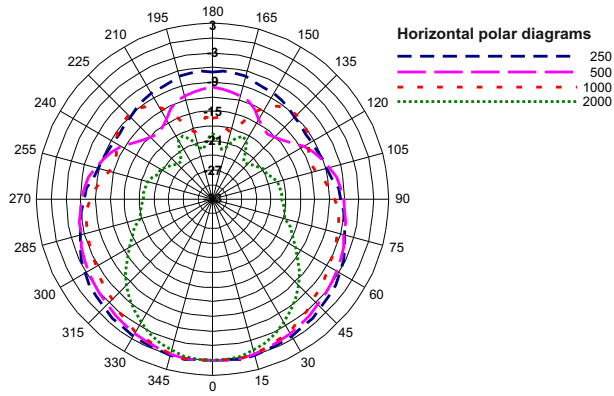

CONTROL PANEL

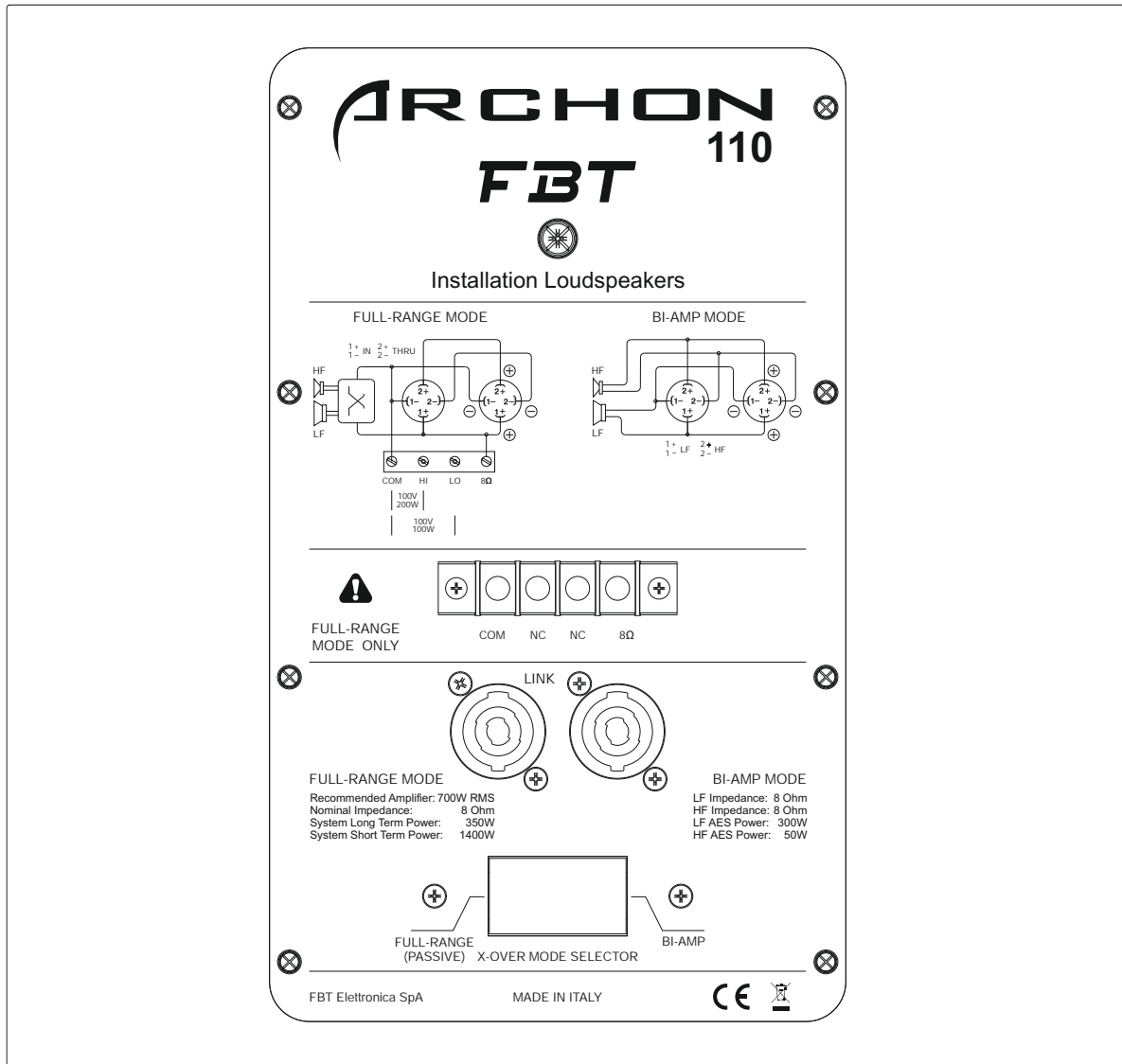

* 2 hours, pink noise with crest factor 2, applied RMS voltage corresponding to the power on the minimum of the module of the impedance of the speaker in full range mode, or of the driver in bi-amp mode.

		FULL-RANGE	BI-AMP (LF)	BI-AMP (HF)
ARCHON 110	* Power →	350W 8 Ohm	300W 8 Ohm	50W 8 Ohm
	X-over freq. 24dB oct. →	-----	HPF 45Hz - LPF 1.8kHz	HPF 1.8kHz

The table shows the power outputs, measured in accordance with the AES standard, that are acceptable by the loudspeaker in FULL-RANGE mode or by the individual drivers in BI-AMP mode.



DIMENSIONAL DRAWINGS

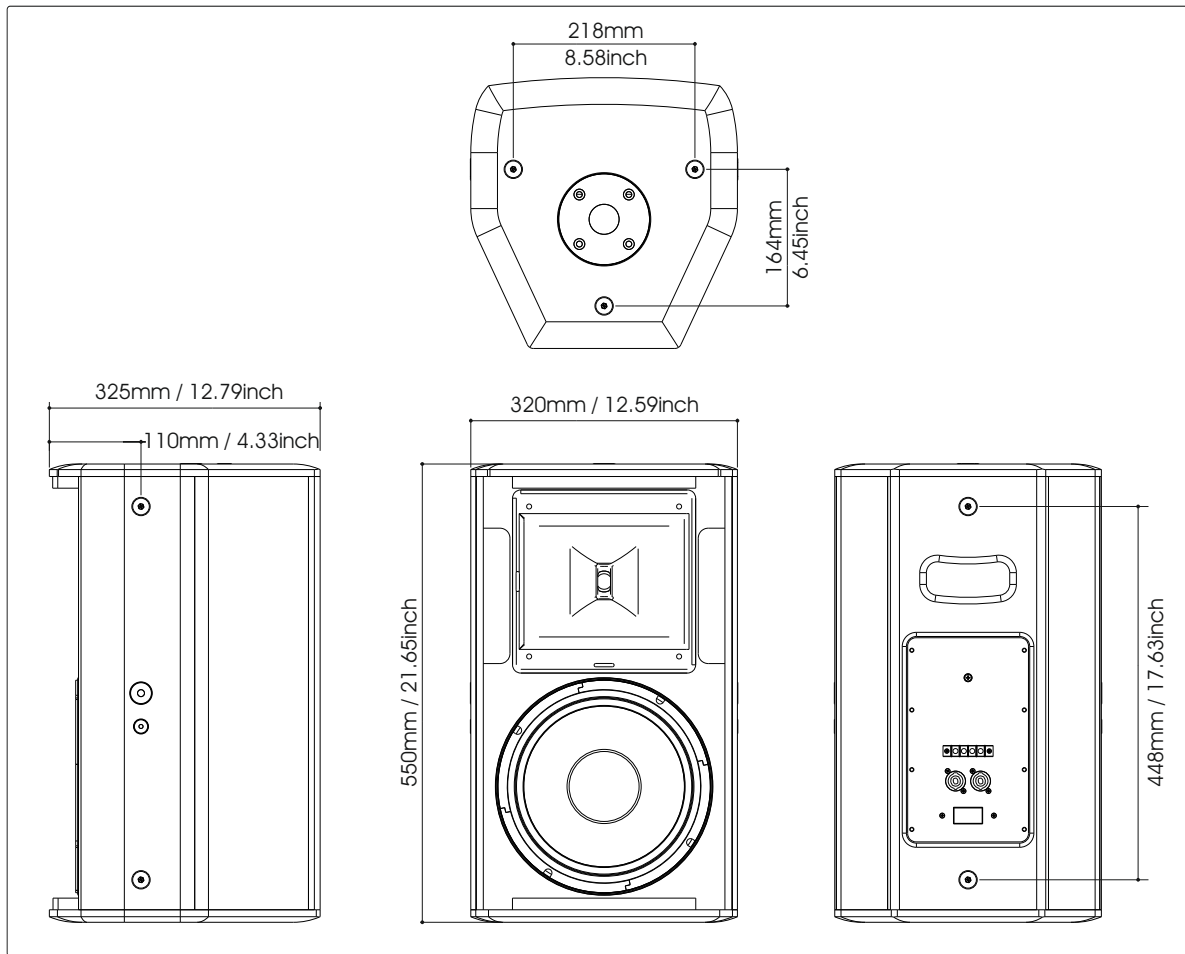

ACCESSORIES

