



# HiMaxX 40a

## PROCESSED ACTIVE MONITOR

### APPLICATIONS

- Live Sound P.A. System or Live Sound Monitor, D.J. System
- School & Corporate Audio Visual Sound Reinforcement
- Background Music/Announcement: Restaurants, Pubs
- Transportation Terminals, Clubs, Auditoriums, Theatres
- Gyms, Houses of Worship

### FEATURES

- Lightweight Polypropylene Cabinet, 39,4 lbs
- Built-in amplifier max. 1000W RMS LF / 250W RMS HF
- B&C custom designed 12" neodymium woofer with 3" voice coil
- B&C 1" compression driver with 1.7" voice coil
- Control panel with Volume control, 3 band Eq., Mic/Line switch, Ground Lift switch, Neutrik balanced inp/out, stereo RCA inputs with separate volume control, Protection & Limiter led indicators.
- Multiple mounting options: wall, ceiling, cluster,
- speaker stand. Optional accessories required.
- Four M10 fly points
- Optional Carrying Bags available for protection for portable use
- High SPL capability: 132.5dB
- Asymmetrical profile allows use as a floor stage monitor
- Two ergonomic handles built in for easy carrying



Designed, Engineered  
and Manufactured in ITALY



### PRODUCT DESCRIPTION

The FBT HiMaxX 40A speaker features lightweight, yet rugged gas injected molded polypropylene cabinet construction. The asymmetrical shape of the HiMaxX 40A cabinet also allows use as a floor stage monitor. The HiMaxX 40A speaker is a two way design incorporating a custom B&C 12" low frequency woofer 3" voice coil with a neodymium magnet structure, die cast aluminum frame and a B&C 1,7" voice coil compression driver coupled to a 90°H x 60°V horn with a 1" exit. The active internal crossover is at a fixed frequency of 1,6kHz. With a frequency range of 45Hz-20kHz, the HiMaxX 40A provides hi fidelity sound for both speech and music applications with a maximum SPL of 132.5dB. A front face steel grille protects the woofer from external damage. The bi amplified HiMaxX 40A active speaker features a 1000W RMS Pulse Width Modulation (PWM) low frequency max. amp and a 250W RMS class G high frequency max. amp. The control panel features a Master volume control, 3 band Eq. with -15/+6dB of cut/boost @ 80Hz LF, -15/+15dB of cut/boost @ 2,5k midrange and -15/+6dB cut/boost @ 10kHz HF, a balanced neutrik input combo jack, balanced XLR link output jack, mic/line input switch, ground lift switch, stereo RCA input with a separate volume control, led power on, protection and limiter overload led indicators. The four M10 fly points built into the cabinet, along with the optional Box 100 or Box 101 mounting brackets allow the HiMaxX 40A speaker to be surface mounted on walls or ceilings. A standard 1,38" speaker stand socket allows the HiMaxX 40A to be mounted on speaker stands.

### ELECTRICAL PERFORMANCE

System Type:	2 Way
Built-in amplifier max. LF/HF	1000W RMS / 250W RMS
Frequency Response @ -6dB	45Hz - 20kHz
Input Impedance	22 kOhm
Input Sensitivity LINE/MIC	0dBu / -38dBu
Maximum SPL ( continuous/peak )*	127dB / 132.5dB
Dispersion	90°H x 60°V
Active Crossover Frequency	1,6 kHz

### PHYSICAL

Low Frequency Woofer	1x12" / 3" Coil
High Frequency Driver	1" - 1,7" Coil
Input Connectors	XLR/Jack, RCA Aux
Net Dimensions (WxHxD)	16" x 24,9" x 14,5"
Shipping Dimensions (WxHxD)	19,5" x 28,3" x 18,5"
Net Weight	39,4 lbs
Shipping Weight	45,2 lbs
Enclosure Material	Polypropylene
Grille	Steel with powder coat black paint finish
Power Cord	196 inch

\* CONT. SPL: free space, based on RMS power amp rating and LF transducer average sensitivity data, 125mS time average  
PEAK SPL: free space, based on peak power amp rating and system peak sensitivity, 10mS time average



# Hi MaxX 40a

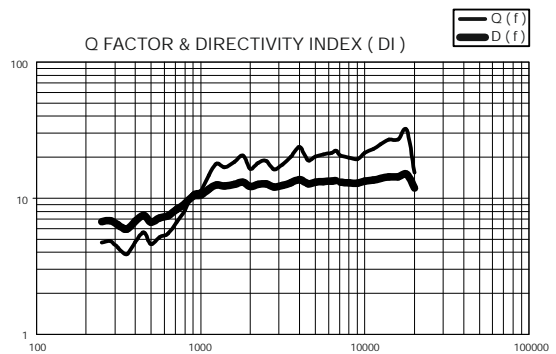
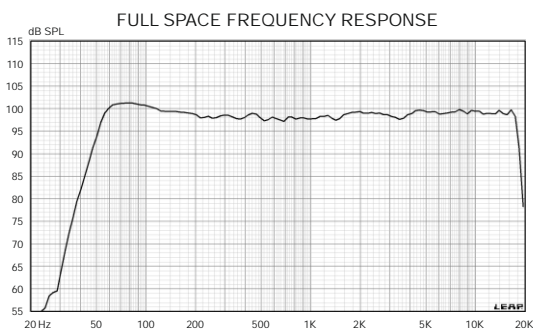
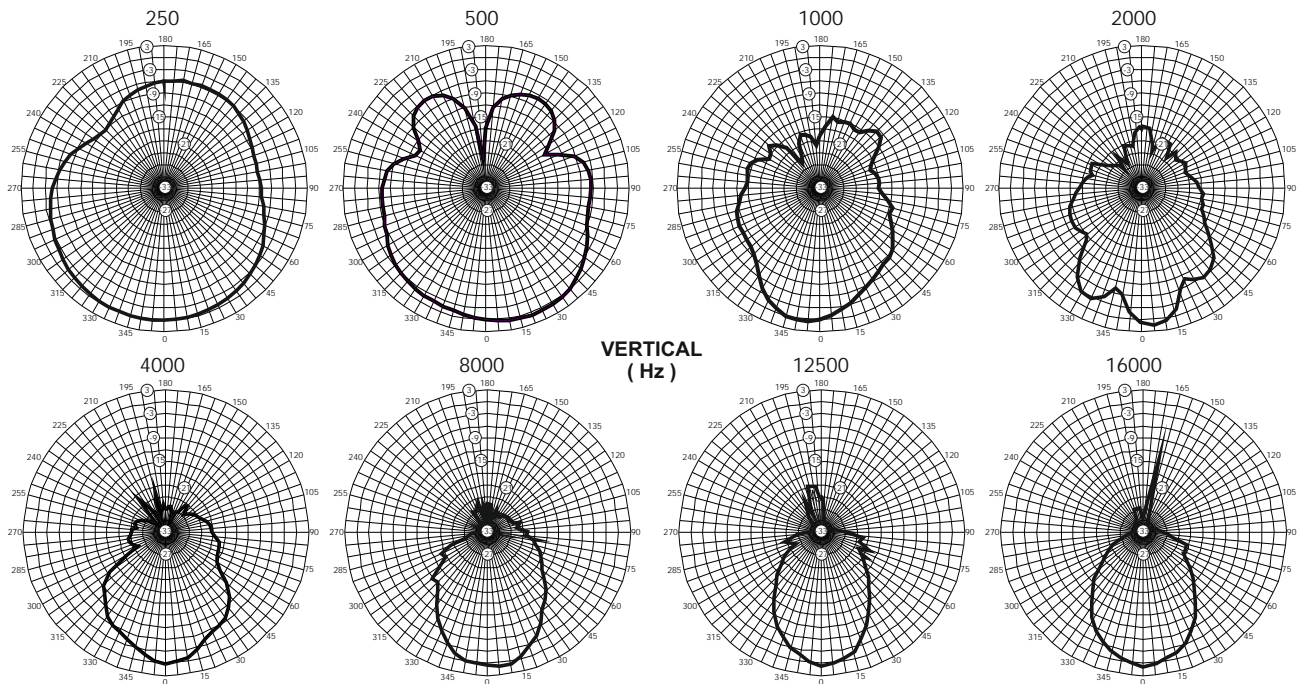
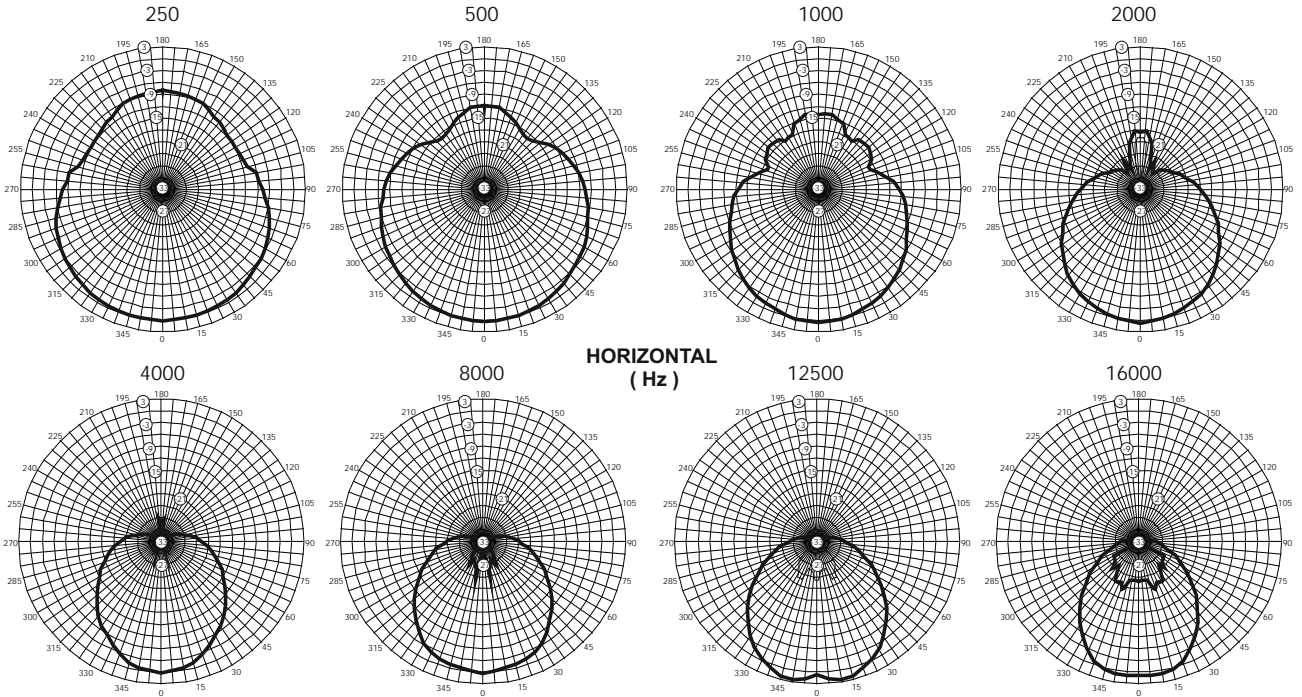



# Hi MaxX 40a

## BLOCK DIAGRAM

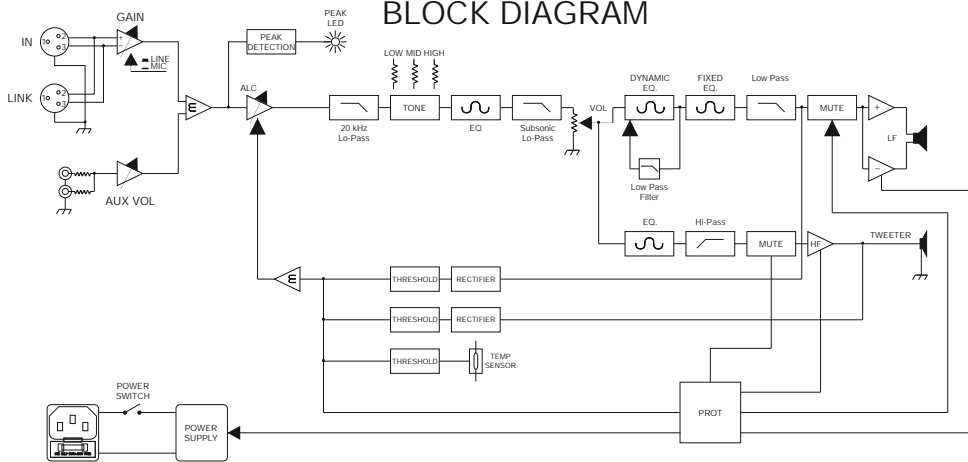

## CONTROL PANEL

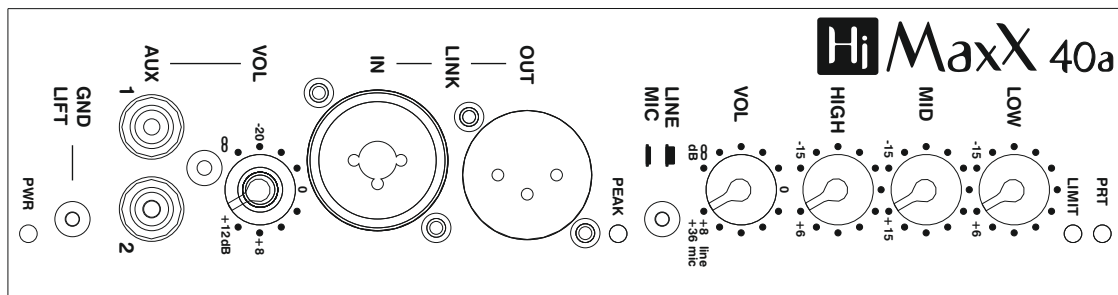

## DIMENSION DRAWING

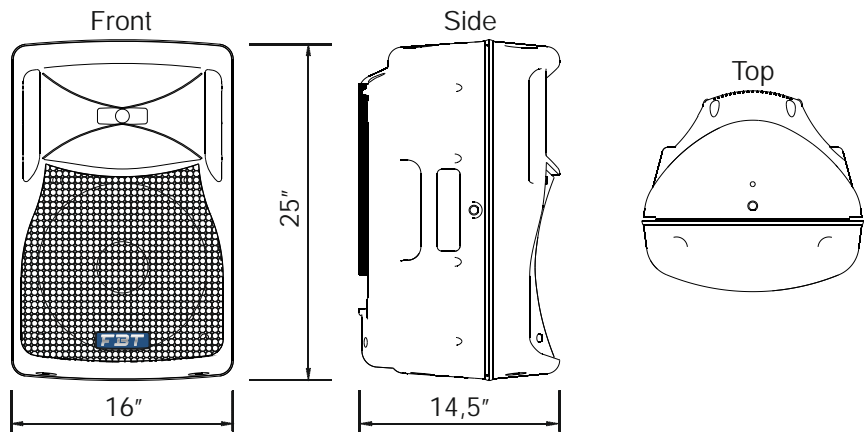

## ACCESSORIES

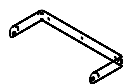

BOX 100  
Mount for  
horizontal  
wall installation

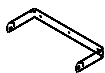

BOX 101  
Mount for  
vertical  
wall installation

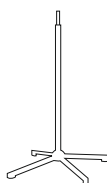

SS2  
Standard speaker  
floor stand

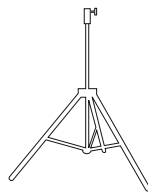

BOX 32BK  
Adjustable aluminium  
floor stand, damped  
safety mechanism

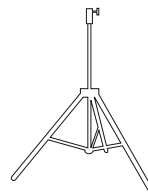

BOX 22BK  
Adjustable aluminium  
floor stand, ø1.38"  
with ø1" adapter



BOX 52BK  
Adjustable for  
sub-satellite  
speaker connection,  
with safety locking  
device

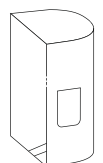

V29  
Nylon case