



MITUS 215

PASSIVE REINFORCEMENT SPEAKER

APPLICATIONS

- Live sound PA system or Live sound monitor, DJ system
- School and corporate audio visual sound reinforcement
- Background music/announcement: Restaurants, Pubs
- Transportation terminals, Clubs, Auditorium, Theatres
- Gyms, Houses of worship

FEATURES

- 15mm / 0.59" baltic birch plywood cabinet
- Recommended amplifier 1600W RMS / 4 Ohm
- 2 x 15" B&C neodymium woofer with 3" voice coil
- 2" exit B&C neodymium driver with 2.5" voice coil
- 60° H x 40° V rotatable horn
- Input panel with 2 x Neutrik speakon NL-4MDV *in & link*
- SPL capability: 138dB
- 12 x M10 fly points
- Completely Manufactured in Italy



PRODUCT DESCRIPTION

The FBT MITUS 215 two-way passive reinforcement speaker system shall incorporate 2 x 15" B&C neodymium woofer with 3" voice coil and 2" exit B&C neodymium driver with 2.5" voice coil coupled to a rotatable 60° x 40° horn; thanks to the rotatable HF horn it is possible to create horizontal arrays of 2 enclosures for a total coverage of 100°. The FBT MITUS 215 shall meet the following performance criteria: Frequency response of 47Hz to 20kHz, Frequency sensitivity of 103dB, Maximum SPL of 138dB, Recommended power amplifier 1600W RMS / 4 Ohm. The FBT MITUS 215 passive speaker feature 0.59" baltic birch plywood construction covered in a scratch & scuff resistant black finish; the front shall be protected by a heavy duty metal grille with anti-resonance spacers and exclusive synthetic cloth to protect the drivers. The hi-grade passive internal crossover featuring «soft-trip» circuitry protection of the LF woofer and HF driver. Input connectors shall be parallel wired Neutrik NL4 speakon. The 12 M10 anchoring points built into the cabinet allow the FBT MITUS 215 speaker to be surface mounted on ceilings.

ELECTRICAL PERFORMANCE

System Type:	2-way
Recommended Amplifier	1600W RMS
Long Term Power (AES)	800W
Short Term Power (IEC 268-5)	2800W
Nominal Impedance	4 Ohm
Frequency Response @ -6dB	47Hz - 20kHz
Sensitivity @ 1W, 1m	103dB
Maximum SPL *	CONT. 134dB PEAK 138dB
Dispersion	60°H x 40°V
Crossover Frequency	1.2 kHz
Recommended HP filter	40Hz-24dB oct.

PHYSICAL

Low Frequency Woofer	2 x 15" - 3" coil
High Frequency Driver	1 x 2" - 2.5" coil
Input Connectors	2 x Speakon NL4 in & thru
Net Dimensions (WxHxD)	19.04" x 49" x 18.5"
	493 x 1245 x 471 mm
Shipping Dimensions (WxHxD)	24.3" x 53.3" x 24"
	618 x 1355 x 610 mm
Net Weight	105.82 lbs / 48 kg
Shipping Weight	117.94 lbs / 53.5 kg
Enclosure Material	0.59" birch plywood

* CONT. SPL: free space, based on recommended amp rating and LF transducer average sensitivity data, 125mS time average
PEAK SPL: free space, based on short term applicable power rating and system peak sensitivity, 10mS time average



DIAGRAMS

Horizontal polar diagrams

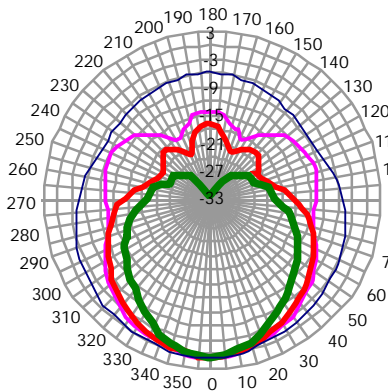

Horizontal polar diagrams

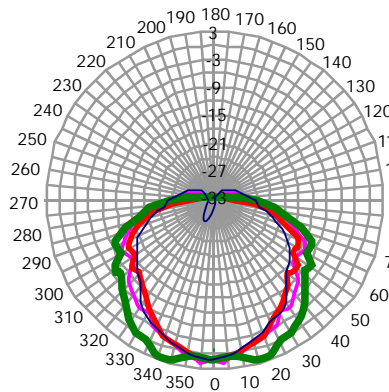
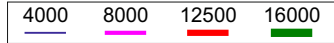

Vertical polar diagrams

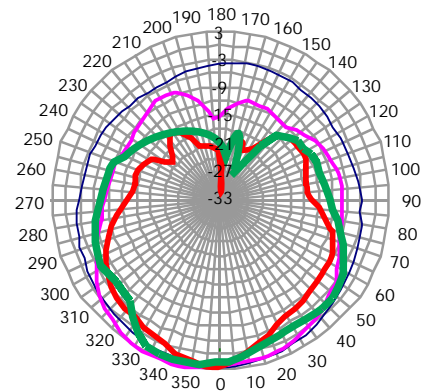

Vertical polar diagrams

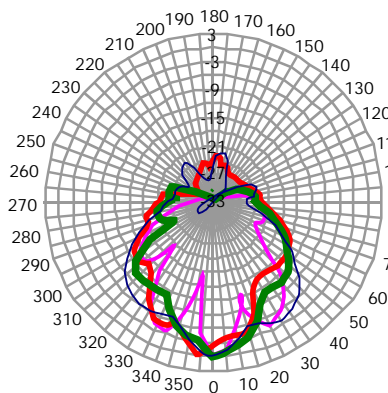
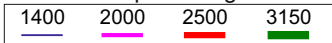

Vertical polar diagrams

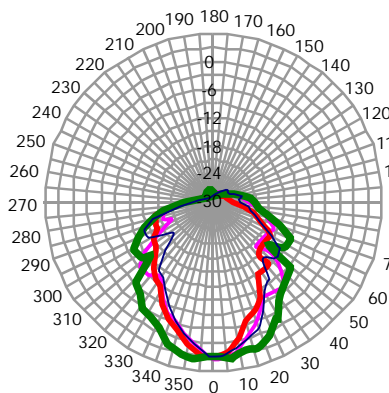
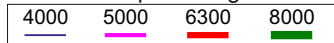

Vertical polar diagrams

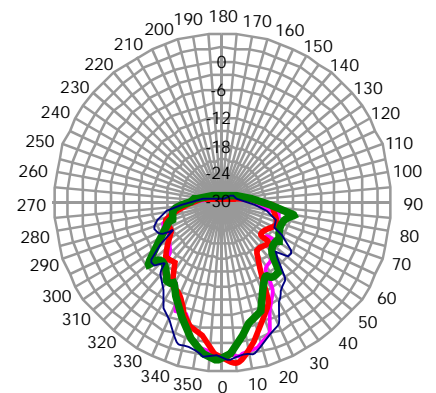

dB SPL FREQUENCY RESPONSE

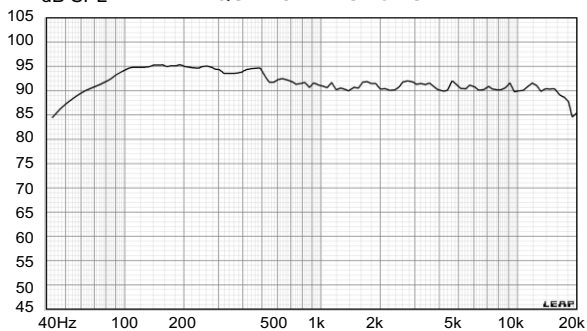

HORIZONTAL BEAMWIDTH (-6dB)

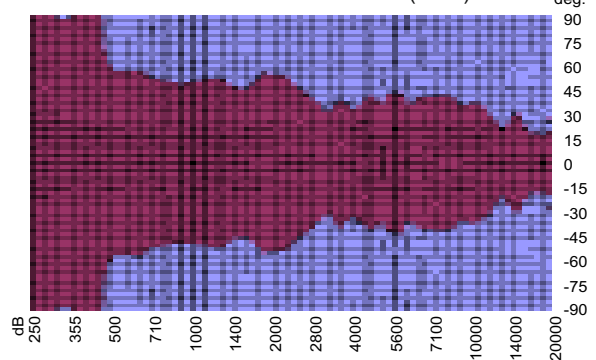

DIMENSION DRAWING

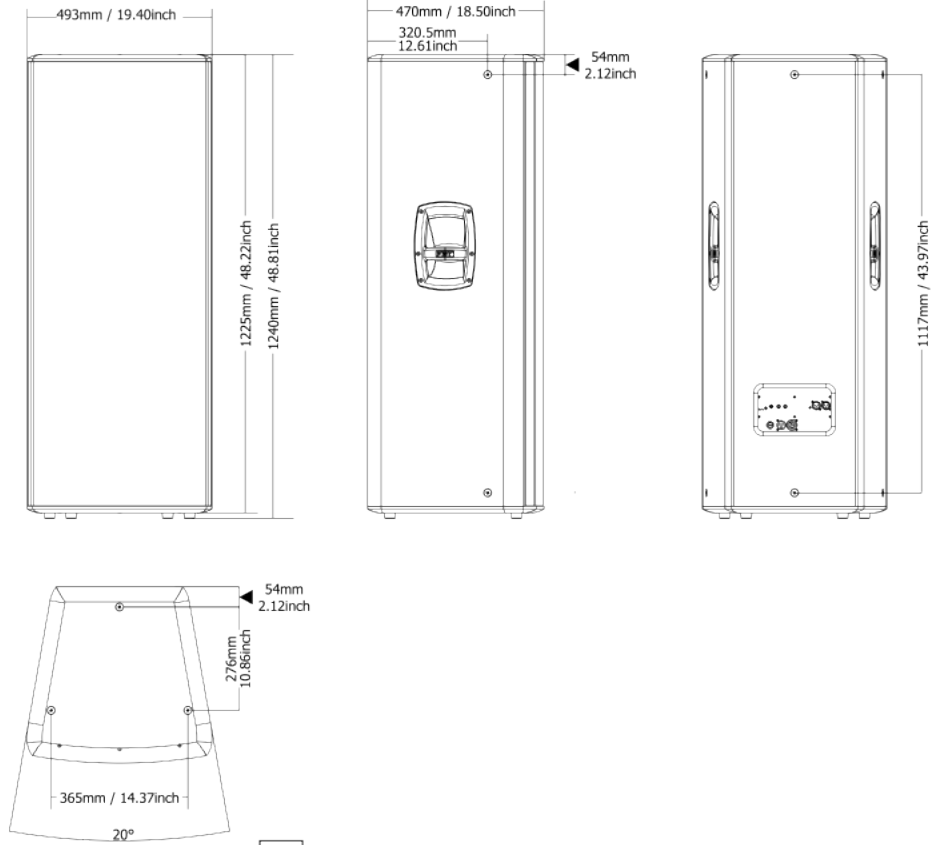

ANCHORING POINT FOR **ONLY ONE** SPEAKER SUSPENDED

CONNECTION PANEL

215 SOUND REINFORCEMENT SPEAKER

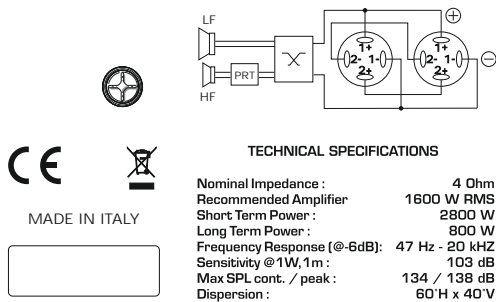

MADE IN ITALY

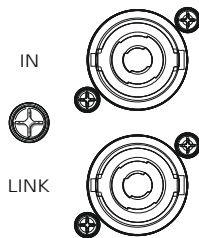

CAUTION:
IT IS IMPORTANT TO USE
AN AMPLIFIER THAT DOES
NOT EXCEED 800W RMS
@ 4 OHM.

ROTATABLE HORN

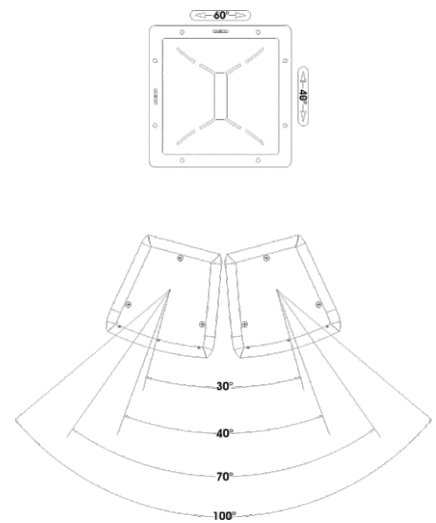

30°----- with 40° horn position
 40°----- with 60° horn position
 70°----- total coverage with 40° horn position
 100°----- total coverage with 60° horn position