

# REQUEST FOR PROPOSAL

## DEVELOPMENT OF MIXED-USE PARKING BUILDINGS

RFP Ref: MCC/BDU/RFP/2022/015  
Date: 20 December 2022

### BACKGROUND

The Male' City Council invites proposals to be submitted for the developer-financed design, development, operation and transfer of a 'Mixed-use Parking Buildings' in Malé.

Additional information regarding the submission of proposals will be available under the 'Request for Proposal (RFP)' uploaded on the Male' City Council Website and the Maldivian Government Gazette.

Male' City Council Website: [www.malecity.gov.mv](http://www.malecity.gov.mv)

Maldivian Government Gazette: [www.gazette.gov.mv](http://www.gazette.gov.mv)

All queries and proposals shall be submitted by email and additional details shall be shared with parties who register their interest for the RFP submission.

Interested parties may register their interest before the deadline through the submission of the registration form available with the RFP document.

Only parties who register their interest shall be eligible for submission of the RFP.

### KEY INFORMATION

#### THE PROJECT

Project Name: Development of Mixed-use Parking Buildings

Proposals are invited for the developer-financed design, development, operation and transfer of Mixed-use Parking buildings in Malé at the locations as per the details given below:

- Locations: Land plots identified from Malé (Refer RFP Documents for details)
- Plot area: Approximately 2,500 sq.ft. to 8,000 sq. ft. (Refer RFP Documents for details)
- Project Requirements:
  - Concept and Detailed Designs of mixed-use parking buildings with commercial components
  - Construction of the mixed-use parking buildings
  - Commissioning of the mixed-use parking buildings and commercial components
  - Operation of the mixed-use parking buildings in line with the approved usage
  - Transfer back to the Lessor on completion of the operation period
- Bid Security
  - Local Parties – MVR 100,000.00
  - Foreign Parties – USD 6,000.00
- Further details of the project requirement is available on the detailed RFP document

### CONTACT



+960 3025441



bdu@malecity.gov.mv



[www.malecity.gov.mv](http://www.malecity.gov.mv)



3<sup>rd</sup> Floor, Male' City Council  
MWSC Customer Service Building  
Ameenee Magu, 20178  
Male', Maldives

### DEADLINES

#### RFP ANNOUNCEMENT

20 December 2022

#### REGISTRATION FOR RFP SUBMISSION

03 January 2023

#### SUBMISSION OF QUERIES

03 January 2023

#### ANSWERS TO QUERIES

08 January 2023

#### RFP SUBMISSION

19 January 2023

## REQUEST FOR PROPOSAL (RFP)

1. The Malé City Council (MCC) is seeking local and international parties for the developer-financed design, development, operation and transfer of the 'Mixed-use Parking Buildings' in Malé, hereafter referred to as the 'Project'.
2. This Request for Proposal (RFP) details the instructions for submitting proposals and the criteria by which a Proponent may be selected for award of the Project.
3. A complete set of the RFP document will be available for eligible interested parties from the Malé City Council (MCC) website at [www.malecity.gov.mv](http://www.malecity.gov.mv) and [www.gazette.gov.mv](http://www.gazette.gov.mv).
4. The milestones, key deadlines and details as relevant pertaining to the RFP is given in the Schedule of Events table below and the subsequent sections of this RFP.

<b>SCHEDULE OF EVENTS</b>		
<b>Milestone</b>	<b>Deadlines</b>	<b>Details</b>
Announcement	20 <sup>th</sup> December 2022 Online on MCC website and Maldivian Government Gazette	<ul style="list-style-type: none"> <li>- Details of the RFP is announced on the MCC website and the Maldivian Government Gazette with publication of the full RFP document for perusal</li> <li>- <a href="http://www.malecity.gov.mv">www.malecity.gov.mv</a>   <a href="http://www.gazette.gov.mv">www.gazette.gov.mv</a></li> </ul>
Registration Deadline	03 <sup>rd</sup> January 2023 13:00 hrs Through email submission	<ul style="list-style-type: none"> <li>- Proponents should register their interest to submit proposals by emailing the duly filled, signed and stamped registration form as given in the RFP to the email address given below:</li> <li>- <a href="mailto:bdu@malecity.gov.mv">bdu@malecity.gov.mv</a></li> </ul>
Deadline for Submission of Enquiries	03 <sup>rd</sup> January 2023 13:00 hrs Submission of written enquiries through email	<ul style="list-style-type: none"> <li>- Only registered parties may submit queries in writing to the email address below:</li> <li>- <a href="mailto:bdu@malecity.gov.mv">bdu@malecity.gov.mv</a></li> <li>- Enquiries should be submitted through the registered emails given by the Proponent</li> <li>- Enquiries submitted through unregistered emails will not be attended</li> <li>- No enquiries shall be attended after the date of closure of enquiries</li> </ul>
Response to Proponents	08 <sup>th</sup> January 2023 13:00 hrs Submission of written responses through email	<ul style="list-style-type: none"> <li>- Enquiries shall be compiled and responses, where applicable, shall be sent to all registered parties to the registered emails</li> <li>- No further clarification shall be addressed after the responses have been sent</li> </ul>
Proposal Submission Deadline	19 <sup>th</sup> January 2023 13:00 hrs Submission of Proposals through email	<ul style="list-style-type: none"> <li>- The Proposals shall be collected through email submissions given below:</li> <li>- <a href="mailto:bdu@malecity.gov.mv">bdu@malecity.gov.mv</a></li> <li>- Proponents may submit the Proposal at any time prior to the closure date</li> <li>- Proposals received after the submission deadline shall not be accepted</li> <li>- Proposals should be emailed as per the formats and requirements given in the subsequent RFP sections</li> </ul>

## SECTION I – INSTRUCTIONS TO PROPONENTS (ITP)

A. GENERAL		
1. Scope of RFP	1.1.	<p>The Lessor: The Malé City Council (MCC), a 100% Maldivian Government body formed under the decentralization law 7/2010 and having its registered office at 3<sup>rd</sup> Floor, MWSC Customer Service Building, Ameenee Magu, 20178, Malé, Maldives (hereafter referred to as 'the Lessor'), issues this Request for Proposal (RFP) for the developer-financed design, development, operation and transfer of the 'Commercial Building' in Villimalé, hereafter referred to as the 'Project' as specified in Section III – Requirements of the Lessor.</p>
	1.2.	<p>The reference number for this RFP is MCC/BDU/RFP/2022/015, which shall be used as a reference for all documentations relevant to this RFP where reference is to be made to this RFP</p>
	1.3.	<p>Throughout this RFP Document:</p> <ul style="list-style-type: none"> <li>(a) the term "in writing" means communicated in written form and delivered against receipt;</li> <li>(b) except where the context requires otherwise, words indicating the singular also include the plural and words indicating the plural also include the singular; and</li> <li>(c) "day" means calendar day.</li> </ul>
2. Corrupt & Fraudulent Practices	2.1.	<p>It is a requirement of the Lessor that Proponents, suppliers, contractors and their agents (whether declared or not), sub-contractors, sub-consultants, service providers or suppliers, and any personnel thereof, observe the highest standard of ethics during the RFP process and execution of Works. In pursuance of this policy, the Lessor:</p> <ul style="list-style-type: none"> <li>(a) defines, for the purposes of this provision, the terms set forth below as follows: <ul style="list-style-type: none"> <li>(i) "Corrupt practice" means the offering, giving, receiving, or soliciting of anything of value to influence the action of a public official in the procurement process or in contract execution; and;</li> <li>(ii) "Fraudulent practice" means a misrepresentation of facts in order to influence a procurement process or the execution of a contract to the detriment of MCC and includes collusive practice among Proponents (prior to or after Proposal submission) designed to establish Proposal prices at artificial non-competitive levels and to deprive the Lessor of the benefits of free and open competition.</li> </ul> </li> <li>(b) will reject a proposal for award if it determines that the Proponent recommended for award, or any of its personnel, or its agents, or its sub-consultants, sub-contractors, service providers, suppliers and/or their employees, has, directly or indirectly, engaged in corrupt or fraudulent practices in competing for the contract in question.</li> <li>(c) will sanction a firm or individual, at any time including declaring such firm or individual ineligible, either indefinitely or for a stated period of time from being awarded a contract from Lessor.</li> <li>(d) will terminate the contract after having given fourteen (14) days' notice to the Proponent.</li> </ul>
3. Eligible Proponents	3.1.	<p>A Proponent must be a foreign or locally registered business (sole trader, partnership or limited liability company) - subject to ITP 3.2</p>

	3.2.	Any foreign registered Proponent should incorporate a local registration, either as a re-registration of the foreign business or formation of an eligible local entity in the relevant authority of the Maldives, prior to signing of the Final Agreement.
	3.3.	A Proponent may jointly apply with another potential Joint Venture Partner. If the Joint venture company is not formed at the time of application, a board resolution of the JV partners indicating the intention to form a JV with the Proponent in case of award of the project should be submitted, along with a signed term-sheet for the proposed Joint Venture agreement stating the shareholding structure, project financing arrangements and any other relevant details.
	3.4.	A Proponent shall not have a conflict of interest. Any Proponent found to have a conflict of interest shall be disqualified. For the purpose of this RFP, a Proponent may be considered to have a conflict of interest, if the Proponent: <ul style="list-style-type: none"> <li>(a) directly or indirectly controls, is controlled by or is under common control with another Proponent; or</li> <li>(b) receives or has received any direct or indirect subsidy from another Proponent; or</li> <li>(c) has the same legal representative as Owner; or</li> <li>(d) has a relationship with another Proponent, directly or through common third parties, that puts it in a position to influence the proposal of another Proponent, or influence the decisions of the Lessor regarding this RFP process; or</li> <li>(e) Submits more than one proposal in this RFP process by the same business entity for the same Project. Participation by a Proponent in more than one Proposal will result in the disqualification of all Proposals in which such Proponent is involved.</li> </ul>
	3.5.	A Proponent shall not be under suspension from proposal submission by the Lessor.
	3.6.	Proponent shall not have a consistent history of court/arbitration award decisions against the Proponent over the last five (5) years.
	3.7.	Proponent shall not have occurrence of non-performance of a contract as a result of the Proponents default over the last five (5) years.
	3.8.	The Proponent shall provide proof of funds, as requested in the final award letter, for the project as per the submitted financial forecast.
	3.9.	A Proponent shall provide such additional evidence, as the Lessor may reasonably request, as proof of eligibility as satisfactory to the Lessor.
<b>B. CONTENTS OF THE RFP DOCUMENT</b>		
4. Sections of RFP Document	4.1.	The RFP Documents include all the sections specified below and should be read in conjunction with any addenda issued in accordance with ITP clause 6. <ul style="list-style-type: none"> <li>• Section I. Instructions to Proponents (ITP)</li> <li>• Section II. Evaluation Criteria</li> <li>• Section III. Requirements of the Lessor</li> <li>• Section IV. Requirements of the Proposal</li> <li>• Section V. Annexes and Forms</li> </ul>
	4.2.	Unless obtained directly from the Lessor, the Lessor is not responsible for the completeness of the RFP Documents, responses to requests for clarification, or Addenda to the RFP Documents in accordance with ITP 6. In case of any contradiction, documents obtained directly by the Lessor shall prevail.

	4.3.	The Proponent is expected to examine all instructions, forms, terms, and specifications in the RFP Documents and to provide with its proposal all information and documentation as is required by the RFP Documents.
5. Clarifications to RFP Document	5.1.	A Proponent requiring any clarification of the RFP Documents shall contact the Lessor via email to the Lessor's address specified in the ITP 5.2, or raise its enquiries during the Clarification Meetings, Webinar if provided for in accordance with ITP 5.3. The Lessor will respond in writing to any request for clarification, provided that such request is received within the deadline as given in the RFP announcement. The Lessor shall provide its response in accordance with the RFP announcement. Should the clarification result in changes to the essential elements of the RFP Documents, the Lessor shall amend the RFP Documents following the procedure under ITP 6 and ITP 17.3.
	5.2.	For <b>clarifications and RFP purposes</b> only, the Lessor's address is:  Attn: Business Development Unit 3 <sup>rd</sup> Floor, Male' City Council MWSC Customer Service Building Ameenee Magu, 20178 Male', Maldives Email: bdu@malecity.gov.mv Website: www.malecity.gov.mv
	5.3.	Interested parties are required to register for Clarifications during the specified period. Only the registered parties may submit requests for clarifications or take part in any Clarification Sessions.
6. Amendments to the RFP Document	6.1.	At any time prior to the deadline for submission of proposal, the Lessor may amend the RFP Documents by issuing addenda.
	6.2.	Any addendum issued shall be part of the RFP Documents and shall promptly publish the addendum on the Lessor's web page in accordance with ITP 5.2.
	6.3.	To give Proponents reasonable time in which to take an addendum into account in preparing their proposal, the Lessor may extend the deadline. for the submission of proposal, pursuant to ITP 17.3.
<b>C. PREPARATION OF THE PROPOSALS</b>		
7. Cost of Bidding	7.1.	All costs associated with the preparation and submission of the proposal shall be at the cost of the Proponent, and the Lessor shall not be liable for any costs incurred by the Proponent, direct or indirect, regardless of the conduct or outcome of the RFP Process.
8. Language of Proposal	8.1.	The RFP, as well as all correspondence and documents relating to the RFP exchanged by the Proponent and the Lessor, shall be written in the ENGLISH or DHIVEHI language.
9. Documents Comprising the Proposal	9.1.	Generally, the Proposal shall comprise of the following documents: (a) Proposal Summary Form in accordance with Section V; (b) Sample of Bid Security with declaration in accordance with ITP 14; (c) Written confirmation authorizing the signatory of the Proposal to commit the Proponent, in accordance with ITP 15.2; (d) Business Proposal Requirement stipulated in Section IV (e) Any other document required in the ITP.

10. Proposal Summary Form	10.1.	The Proposal Summary Form shall be prepared using the relevant formats furnished in Section V. The forms must be completed without any alterations to the text, and no substitutes shall be accepted except as provided under ITP 15.2. All blank spaces shall be filled in with the information requested.
	10.2.	The Proponent shall quote prices conforming to the requirements specified in Section II and Section III and fill in the Proposal Summary Forms in accordance with Section V.
11. Documents Comprising the Business Proposal	11.1.	The Proponent shall furnish the required Business Proposal including Proposal Summary Form, Bid Security Format, Legal documents, financial documents, Operational/Business plan, Concept Design, documents confirming the experience in relevant field and any other information as stipulated in Section IV, in sufficient detail to demonstrate the adequacy of the Proponent's proposal to meet the work requirements.
12. Currencies of Proposal	12.1.	The currency(ies) of the proposal may be quoted in Maldivian Rufiyaa (MVR) or United States Dollars (USD).
13. Validity of Proposals	13.1.	Proposal shall remain valid for a period of <b>One Hundred and Eighty (180) days</b> after the proposals are submitted to the Lessor in accordance with submission details specified in ITP 17.2. Any proposal submitted specifying a period shorter than the requirement stated above may be rejected by the Lessor.
14. Bid Security	14.1.	The Proponent shall furnish a draft of the bid security at the time of submission and when requested at the time of conditional award, the Bid Security in original form bid security, in the amount as required in the RFP announcement in the currencies as specified below:  (a) if the Proponent is a locally registered party, the Bid Security amount should be specified in <b>Maldivian Rufiyaa</b> .  (b) if the Proponent is an International party not registered locally at the time of submission of the Proposal, the Bid Security amount should be specified in <b>United States Dollars</b> .
	14.2.	The Bid Security shall be valid for <b>180 (One Hundred and Eighty) days</b> from the date the bid security is submitted to the Lessor.
	14.3.	The Bid Security shall be a demand guarantee in forms of an unconditional guarantee issued by a locally registered Bank or financial institution (such as an insurance, bonding or surety company). The bid security shall be submitted using the Bid Security Form included in Section V.
	14.4.	The Lessor may declare the proposal non-responsive if the proposal is submitted without the draft of the bid security and if the subsequent original is not submitted when requested.
	14.5.	The bid security of the successful Proponent shall be returned as promptly as possible once the successful Proponent signs the Final Agreement and furnishes the required Performance Security.
15. Format and Signing of Proposals	15.1.	The proposals should be submitted electronically from the Proponents registered email as an attachment in Adobe Acrobat (file extension .pdf) readable format as a combined file, to a cover email or if the attachment file size exceeds limitations as allowed to email, then a downloadable link authorized to the Lessor email should be sent with the email.  All attachments should be password protected and the passwords are to be submitted as a separate email prior to the submission deadline. If requested by the Lessor, an original of the proposal document should be submitted to the Lessor as described in ITP 5.2.

	15.2.	The original and all copies of the proposal shall be typed or written in indelible ink and shall be signed by a person duly authorized to sign on behalf of the Proponent. This authorization shall consist of a written confirmation of a Power of Attorney to sign on behalf of the Proponent. The name and position held by each person signing the authorization must be typed or printed below the signature. All pages of the proposal where entries or amendments have been made shall be signed or initialed by the person signing the proposal.
	15.3	Any inter-lineation, erasures, or overwriting shall be valid only if they are signed or initialed by the person signing the proposal.
16. Sealing and Marking of Proposals	16.1.	Where originals and copies are to be submitted, the Proponent shall enclose the proposal. These envelopes containing the original and the copies shall then be enclosed in one single envelope.
	16.2.	The proposal should bear a cover page with the following details as per the format given in Section V: (a) the name and address of the Proponent (b) the Project name and RFP Reference number (c) addressed to the Lessors address given in the RFP (d) completed checklist of documents to be submitted as given in Section V (e) name, address, contact number and contact person on behalf of the Proponent (f) registration number and stamp of the Proponent (g) originals submitted to the Lessor should be submitted in a sealed envelope with the above details given in a cover letter and with the envelope bearing a warning not to be opened except by the Lessors representatives overseeing the RFP process as described in ITP 5.2.
	16.3.	The Lessor shall not assume any responsibility for the misplacement or opening of any originals of proposal envelopes not sealed and marked as required.
17. Deadline for Proposal Submission	17.1.	Proposals must be received to the Lessors email address no later than the date and time specified in the RFP Announcement. Proponents may choose to submit the proposal electronically by email any time prior to the deadline for submission. All attachments should be password protected and the passwords may be submitted as a separate email prior to the submission deadline. It is the responsibility of the Proponent to ensure that the email is received to the Lessor and the Lessor shall not bear any responsibility for any technical issues hindering the receipt of the electronic submission to the Lessor.
	17.2.	All submissions, unless otherwise stated in the RFP, are to be submitted electronically. The deadline for the proposal submission shall be given in the RFP Announcement.
	17.3.	The Lessor may, at its discretion, extend the deadline for the submission of proposals by amending the RFP Documents in accordance with ITP 6, in which case all rights and obligations of the Lessor and Proponents previously subject to the deadline shall thereafter be subject to the deadline as extended.
18. Late Proposal	18.1.	The Lessor shall not consider any proposals that is received, either electronically or in original copies where requested, after the deadline for submission of proposal. Any proposal received by the Lessor after the deadline for submission of proposal shall be declared late, rejected, and returned (where applicable) to the Proponent.

19. Proposal Opening	19.1.	With respect to the ongoing Covid-19 pandemic, where practical, the Lessor shall adhere to the guidelines as announced by the relevant authorities such as HPA and other health authorities to minimize physical interactions in the RFP process and proposal submissions.
	19.2.	All proposals submitted through electronic media shall be opened and reviewed after the submission deadline. All submissions and proposal opening shall be conducted electronically.
	19.3.	All registered Proponents shall be emailed a list bearing the name of Proponents and any other details as the Lessor deems appropriate. However, the provided list of submitted Proponents is not a substantiation of the final responsiveness or rankings of the proposals. The Lessor shall neither discuss the merits of any proposal nor reject any proposal at this stage except for late proposal in accordance with ITP 18.1.
<b>D. EVALUATION OF PROPOSALS</b>		
20. Confidentiality	20.1.	Information relating to the ongoing evaluation of proposals, comparison of proposals and recommendation of contract award shall not be disclosed to Proponents or any other persons not officially related to the RFP process until information on Contract award is communicated to all Proponents in accordance with ITP 29.
	20.2.	Any attempt by a Proponent to influence the Lessor in the evaluation of the proposals or Contract award decisions may result in the rejection of its proposal of the Proponent.
	20.3.	Notwithstanding ITP 20.2, from the time of proposal opening to the time of Contract award, if a Proponent wishes to contact the Lessor on any matter related to the RFP process, it shall do so in writing.
21. Clarifications for Proposals	21.1.	To assist in the examination, evaluation, and comparison of the proposals, and qualification of the Proponents, the Lessor may, at its discretion, ask any Proponent for a clarification of its proposal, giving reasonable time for a response. Any clarification submitted by a Proponent that is not in response to a request by the Lessor shall not be considered. The Lessor's request for clarification and the response shall be in writing. No change, including any voluntary increase or decrease, in the proposed rates or figures or substance of the proposal shall be sought, offered, or permitted, except to confirm the correction of arithmetic errors discovered by the Lessor in the evaluation of the proposals, in accordance with ITP 24.
	21.2.	If a Proponent does not provide clarifications of its proposal by the date and time set in the Lessor's request for clarification, its proposal may be rejected.
22. Deviations, Reservations & Omissions	22.1.	During the evaluation of proposal, the following definitions apply: (a) "Deviation" is a departure from the requirements specified in the RFP Documents. (b) "Reservation" is the setting of limiting conditions or withholding from complete acceptance of the requirements specified in the RFP Documents; and (c) "Omission" is the failure to submit part, or all of the information or documentation required in the RFP Documents.
23. Determination of Responsiveness	23.1.	The Lessor's determination of a proposal's responsiveness is to be based on the contents of the proposal itself, as defined in ITP 9.



	23.2.	A substantially responsive proposal is one that meets the requirements of the RFP Documents without material deviation, reservation, or omission.
	23.3.	A material deviation, reservation, or omission is one that, (a) if accepted, would (i) affect in any substantial way the scope, quality, or performance of the Works specified in the Contract; or (ii) limit in any substantial way, inconsistent with the RFP Documents, the Lessor's rights or the Proponent's obligations under the proposed Contract; or (b) if rectified, would unfairly affect the competitive position of other Proponents presenting substantially responsive proposal
	23.4.	If a proposal is not substantially responsive to the requirements of the RFP Documents, it shall be rejected by the Lessor and may not subsequently be made responsive by correction of the material deviation, reservation, or omission.
24. Correction of Arithmetical Errors	24.1.	Provided that the proposal is substantially responsive, the Lessor may correct arithmetical errors on the following basis: (a) if there is a discrepancy between the unit price and the total price that is obtained by multiplying the unit price and quantity, the unit price shall prevail and the total price shall be corrected, unless in the opinion of the Lessor there is an obvious misplacement of the decimal point in the unit price, in which case the total price as quoted shall govern and the unit price shall be corrected; (b) if there is an error in a total corresponding to the addition or subtraction of subtotals, the subtotals shall prevail and the total shall be corrected; and (c) if there is a discrepancy between words and figures, the amount in words shall prevail, unless the amount expressed in words is related to an arithmetic error, in which case the amount in figures shall prevail subject to (a) and (b) above.
	24.2.	Proponents shall be requested to accept correction of arithmetical errors. Failure to accept the correction in accordance with ITP 24.1, shall result in the rejection of the Proposal.
25. Evaluation of Proposals	25.1.	The Lessor shall use the criteria and methodologies listed in Section II Evaluation Criteria.
26. Lessor's Right to Accept Any & to Reject Any or All Proposals	26.1.	The Lessor <b>reserves</b> the right to accept or reject any proposal, and to annul the RFP process and reject all proposal at any time prior to contract award, without thereby incurring any liability to Proponents. In case of annulment, all proposals submitted and specifically, bid securities, shall be promptly returned to the Proponents.
<b>E. AWARD OF CONTRACT</b>		
27. Award Criteria	27.1.	Subject to ITP 26.1., the Lessor shall conditionally award the Contract to the Proponents whose proposal has been determined to be substantially responsive to the RFP Documents and scored the highest marks from each category as specified in ITP 25., provided further that the Proponent is determined to be qualified to perform the Contract satisfactorily. The Lessor has liberty to select the highest-ranking Proponent to be awarded the Contract whilst selecting a second and third ranking Proponent to be given opportunities to progress should the awarded Proponents fail to fulfil the terms of the conditional award.

28. Notification of Award	28.1.	Prior to the expiration of the period of proposal validity, the Lessor shall notify the successful Proponent, in writing, that its proposal has been accepted.
	28.2.	Until a formal contract is prepared and executed, the successful Proponents' proposal and the notification of award shall constitute a binding Contract.
29. Signing of Agreements	29.1.	Promptly upon notification of the conditional award, the Lessor shall send the successful Proponent the Framework Agreement.
	29.2.	The Framework Agreement shall define the terms of negotiations and further requirements to be finalized prior to signing of the Final Agreement and confirmation of the Project to be awarded to the Proponent.
	29.2.	The Final Agreement will be forwarded to the Proponent on successful completion of the terms of the Framework Agreement and on finalization of the approval to award the Final Contract. The Final Contract will be signed after the receipt of any due payments or documentations as per ITP 31. and ITP 33. of this RFP, and on submission of the Performance Guarantee as per ITP 32. of this RFP.
30. Termination	30.1.	In case of any material breach of any of the Contractual obligations by the Proponent, the Lessor shall have the right to terminate the contract without prior notice.
31. Payment for Development Rights	31.1.	The Proponent shall be required to make payment for the development rights (if applicable) on the project at the rate as defined in the Section III clause 5., as compensation to the Lessor for assigning the development. The rate and the payment terms are subject to final negotiations prior to the signing of the Final Agreement. The development rights shall be paid in regard to the total GFA of the project based on the final development details as agreed between the Proponent and the Lessor.
32. Performance Guarantee	32.1.	Prior to the signing of the Final Agreement, the Lessor reserves the right to call for the placement of a Performance Guarantee from the Proponent and unless otherwise agreed, the Performance Guarantee should be provided as per the terms and conditions to be agreed for the Final Agreement.
	32.2.	The Performance Guarantee amount shall be based on the value of the project as proposed by the Proponent generally within the limitation as given below but not exceeding 1.5% of the overall value of the project. The final value of the required Performance Guarantee shall be based on the final scope of the Project as agreed between the Lessor and the Proponent and in currencies as stated below: (a) for locally registered Proponents the Performance Guarantee shall be placed in Maldivian Rufiyaa. (b) for international Proponents the Performance Guarantee shall be placed in United States Dollars.
	32.3.	The Performance Guarantee shall be issued by registered Bank or financial institution (such as an insurance, bonding or surety company) as per the format included in Section V.
	32.3.	The Performance Guarantee shall be valid for 12 (twelve) months from the date of signing the Final Agreement, and shall be renewed annually until the completion of the construction period.

	32.4.	Failure to pay the Performance Guarantee within the specified time periods in the letter of award will result in the annulment of conditional award of contract.
33. Lease Deposit	33.1.	Prior to the signing of Final Agreement in accordance with ITP 29.1, the successful Proponent shall pay a lease deposit to the account which will be notified in the Letter of Award. The applicability of the lease deposit and the amounts shall be based on the Proponents proposal but shall generally not exceed an exposure of three months dues as proposed by the Proponent.
	33.2.	Failure to pay the applicable lease deposit within the specified time period may result in the annulment of conditional award of contract.

## SECTION II – EVALUATION CRITERIA

This Section provides details of the criteria that the Lessor shall use to evaluate the Proponents proposals and to qualify and assign rankings for the proposals. In accordance with ITP clause 25., the Lessor shall consider the details given below and no other factors, methods or criteria shall be used in the evaluation of the proposals.

The Proponent is required to provide a summary brief of these evaluation requirements using the sample forms given in Section V and the proposals shall fulfill the requirements in accordance with the ITP clause 9.1.

The Proponent is at liberty to provide any support or detailed information in support of the Proponents proposal along with the information provided in the forms given in Section V. However, the information provided in the required forms shall be considered in the first evaluation and any support details shall only be referred to where clarifications are needed.

The evaluation of the proposals shall be conducted based on the following categories and scoring assigned as the guidelines given below:

1. Proposed Rent: 40%	1.1.	The minimum accepted lease rent for the development is Maldivian Rufiyaa 20/- (Twenty) per square feet per month for the land area assigned for the development. Any proposal which is less than the said lease rate shall be disqualified.
	1.2.	Proponents are required to propose a lease rent for the land allocated for the development as a lease rent per square feet per month for the first five (05) years. For clarity, the rent periods shall be counted excluding any final agreed grace periods given for the development.
	1.3.	The proposed lease rent should cover the first 5 years either as a flat rate throughout the first five (05) years or on an escalation based on annual increments as proposed by the Proponent.
	1.4.	Lease rents beyond the initially proposed five (05) years shall be revised every two (02) years based on market inflation using the following formula: $P(1+i+5\%)$ , where 'P' represents the ending years final monthly lease rate, 'i' represent the cumulative inflation for the preceding two (02) years.
	1.5.	The proposed lease rate shall be evaluated using the Net Present Value (NPV) of the proposed rent for the first five (05) years at a discount rate of 10%.
	1.6.	The Proponent with the highest acceptable NPV shall be given the maximum score whereby points shall be assigned to remaining Proponents on a prorated basis.
	1.6.	To avoid manipulation of the scoring by providing unrealistic lease rents, the Lessor shall use an outlier formula to eliminate outliers, both on the lower end and the higher end of the rent proposals.
2. Development Cost: 20%	2.1.	In order to achieve the overall requirements of the development as planned for by Lessor, the Lessor shall strive to maintain reasonable costs controls in the development to make the development financially sustainable while also encouraging reduction in the costs of services provided to the public from the development. Towards this end, proposals that are in line with the overall project value target as planned for by the Lessor shall be given priority.
	2.2.	For the purpose of the valuation of the development, the Proponent should quote separately the estimated development costs of the proposed parking floors as mandated for development by the Lessor

		<p>and the estimated balance costs of the Proponents own proposed developments.</p> <p>The Proponent may quote the total estimated costs of the development for the Lessors review, however, for the purpose of the evaluation, the Lessor shall only consider the apportionate development cost of the parking areas only.</p> <p>For reference, the estimated project values for the development of the parking areas (excluding the Proponents Commercial floors) for individual plots assigned for this development is Maldivian Rufiyaa 5,000,000/- (Five Million) to 45,000,000/- (Forty-Five Million) depending on the size of the plot.</p>
	2.3.	The Proponent with the lowest estimated value for the proposed parking areas shall be given the maximum score whereby points shall be assigned to remaining Proponents on a prorated basis.
	2.4.	To avoid manipulation of the scoring by providing unrealistic project estimates, the Lessor shall use an outlier formula to eliminate outliers, both on the lower end and the higher end of the cost proposals.
3. Lease Period: 20%	3.1.	The land allocated for this project is to be assigned to the Proponent on a lease basis and the ownership of the land will remain with the Lessor. For clarity, there is no offer to sell the land to the Proponent and the offer of lease is final and all proposals submitted by the Proponents shall give due consideration to this and any proposal with terms contradictory to the offer of lease shall be disqualified.
	3.2.	<p>Provided that the period proposed is not contradictory to the current legal framework, Proponents may propose a lease period that fulfills the Proponents financial feasibility and viability targets depending on the value and justifications of the Proponents investment.</p> <p>The Proponent with the shortest proposed lease period shall be given the maximum score whereby points shall be assigned to remaining Proponents on a prorated basis.</p>
4. Concept Design: 10%	4.1.	Proponents may submit a design concept based on the Lessors project requirement as a means to assess the Proponents planned developments match with the requirements of the Lessor.
	4.2.	Scoring shall be given based on the clarity of the proposed concept achieving the requirements of the Lessor, adaptation of the design to minimize impact to the nature and surroundings, functionality of the designs, durability of the proposed materials and the overall aesthetics and design.
	4.3.	The Proponent with the highest evaluation shall be given the maximum score whereby points shall be assigned to remaining Proponents on a prorated basis.

5. Capacity of Proponent: 10%	5.1.	The Lessor shall strive to assess the capacity of the Proponents and to rank proposals that are submitted by Proponents who show considerable capability and capacity to fulfill the development as proposed.
	5.2.	Towards this end, the Lessor shall assess the Proponents capacity based on the experience of having undertaken similar developments in line with related civil works developments, experience of the Proponent through completed or ongoing projects, financial capacity of the Proponent through assessment of the Proponents financials and availability of financial and other resources accessible to the Proponent.

## SECTION III – REQUIREMENTS OF THE LESSOR

This Section provides details the Project requirement of the Lessor giving a guideline on the overall plans for the development as envisaged by the Lessor. Whilst the Proponent may supplement these requirements with components that add value to the overall development, the Proponent should ensure that the components and requirements as proposed by the Lessor is met.

1. Minimum Scope of the Project	1.1.	Finance, develop, operate and transfer mixed-use parking buildings on the land as assigned for this project as detailed in Section V. The Proponent may choose one or more locations from among the plots identified in the Annex but the Lessor reserves the right to limit the award based on the Proponents financial capacity to undertake the selections.
	1.2.	The Proponent shall be required to finance the development, undertake the detailed designs, complete the development, and operate the parking areas and commercial developments under the Lessors hold, during the lease period and transfer the developed assets to the Lessor after the completion of the lease period.
	1.3.	The primary components of this development covers the following: (a) Site preparation sufficient for the development. (b) Construction and development of the mixed-used parking buildings on the allocated land. (c) The development should be in line with the development guidelines given in Section V, whereby priority shall be given to building usage that is allocated for parking spaces as proposed in the development guideline. (d) Installation of the utility services within the site as required to provide the utility services to the development. (e) Development of any other supplementary facilities as may be required to implement the minimum developments as given above by the Lessor. (f) Implementation of any other facilities or developments as proposed by the Proponent and implemented with approval of the Lessor.
2. Operating Business Model	2.1.	The Proponent is required to hand over the parking areas to the Lessor on completion and commissioning of the building and the Proponent shall have the right to operate the commercial developments as approved for development by the Lessor. The Lessor shall not give the approval to operate any commercial activity proposed by the Proponent until the parking areas are completed and handed over to the Lessor. The proposed commercial activity in the development can be operated by the Proponent or leased out as components from the development to any third parties.
	2.2.	The Proponent may supplement the income from the buildings through the installation of advertisement spaces on the Building, provided the Lessor is given access to utilize such spaces as per terms of the Final Agreement.
	2.3.	The Proponent is not allowed to pass on the entire rights of the development or operating rights to any third party without the consent of the Lessor.
	2.4.	Should the Proponent wish to divest the lease rights in its entirety, the Lessor should be given first right of refusal, whereby both parties shall in good faith negotiate the value of such sale either by negotiating directly or by the engagement of an independent valuer to determine such value.
	2.5.	The Proponent shall ensure that the developments are insured, maintained and secured during the lease period and apart from fair wear and tear, the development should be handed over to the Lessor on completion of the Lease period in fair and operable condition.

3. Implementation of the Project	3.1.	Prior to the commencement of the works, the Proponent should prepare and approve the concept and detailed drawings of the development from the Lessor.
	3.2.	Such designs and details should be within the guidelines as implemented by the relevant authorities and it is the Proponents responsibility to ensure the designs comply with such requirements and obtain such approvals.
	3.3.	The land for the development shall be handed over to the Proponent to undertake the development on an as-is-where-is basis and the Proponent should factor in any site conditions to the development costs.
	3.4.	The Proponent should submit the detailed workplan and schedules for inclusion in the Final Agreement and any requested grace period and Project Schedule shall be subject to the approval of the Lessor.
	3.5.	The Proponent shall be required to comply with the development targets as agreed in the Project and the Lessor reserves the right to monitor the progress and terminate the Agreement if the Proponent incurs any significant delays in the implementation of the Project.
4. Payment of Lease Rent	4.1.	Payment of land lease as long-term rent to be proposed by Proponent within the criteria's as specified in Section II: Evaluation Criteria
5. Payment for Development Rights	5.1.	<p>The Lessor reserves the rights to charge payment for the Development Rights over the proposed Project, where such Development Rights valuation shall be as a total component of the total developed GFA as proposed by the Proponent, subject to the Final Agreement and designs.</p> <p>The total valuation of the Development Rights is to be paid to the Lessor through the handover of developed floor areas from the Project to the Lessor, subject to final negotiations and agreements between the Lessor and the Proponent prior to signing the Final Agreement.</p> <p>The Valuation for the Development Rights and the terms of payments are as follows:</p> <ul style="list-style-type: none"> <li>(a) Development rights for the Project shall be valued at MVR 150/- (one hundred fifty) per square feet for the total GFA of the Project.</li> <li>(b) Valuation for GFA handed over to Lessor shall be valued at MVR 1,300/- (one thousand three hundred) per square feet for the GFA proposed to be handed over to the Lessor on completion of the construction of the Project.</li> </ul> <p>The valuations proposed above are subject to the final designs and details as to be agreed between the Lessor and the Proponent prior to signing of the Final Agreement.</p>



## SECTION IV – REQUIREMENTS OF THE PROPOSAL

The proposals submitted by the Proponents should comply with the requirements of the proposal given below and the information as requested below shall be used to determine the qualifications of the Proponent to perform the contract and to determine the proposal as being substantially responsive.

The documents and information required below shall be requested in two stages whereby the first stage shall be for the qualification of the responsiveness and determination of the Proponents to be selected for award of the contract and information requested in stage two shall be for primarily required for the finalization of the detailed Final Agreement without any material deviations from the selections and documents as submitted in stage one.

Stage 1 – documents shall be required at the time of submission of the Proposal and the Lessor reserves the right to declare the Proponents proposal as non-responsive on failure to include any of the documents listed.

Stage 2 – documents that are required to be submitted after the Lessor gives notice of the conditional award to the Proponent and to be submitted prior to signing of the Final Agreement.

Stage 1 Documents		
1. Documents to be enclosed along with the Proposal at the time of Proposal Submission	1.1.	Proposal Cover Page
	1.2.	Proposal Submission Form
	1.3.	Bid Security Draft with signed declaration
	1.4.	Signed Partnership Term sheet if Proponents wish to form a partnership
	1.5.	Business Registration Copy
	1.6.	Company Profile
	1.7.	Project References
	1.8.	MOA of the Proponent
	1.9.	AOA of the Proponents
	1.10.	Comfort Letters from financial institutions if project is to be undertaken from Borrowings
	1.11.	Board Resolution from Directors if project is to be implemented from Proponents own funds
	1.12.	Draft Concept design
	1.13.	Audited Financial Statements for past 3 years or Management Accounts for the most recent year
	1.14.	Signed Due Diligence Declaration
	1.15.	Power of Attorney authorizing Proponents representative to sign and submit proposal
	1.16.	Any revisions to the registered email or authorized contact person who will represent the Proponent
	1.17.	Any other details that the Proponent may wish to submit at this stage in support of the Proponents Proposal

Stage 2 Documents		
2. Documents to be submitted during the agreement negotiation stage for signing of the Final Agreement	2.1.	Original of the Bid Security
	2.2.	Final Concept Design and Detailed Drawings
	2.3.	Proof of Funds for the Project
	2.4.	<p>Detailed Business Plan for the development covering a minimum of the following components:</p> <p>(a) Management and HR Plan</p> <ul style="list-style-type: none"> <li>• Team undertaking the Management of the completed development</li> </ul> <p>(b) Marketing Plan</p> <ul style="list-style-type: none"> <li>• Marketing Strategy and Product Plans</li> <li>• Target Pricing and Target Segments</li> <li>• Promotional Strategies</li> </ul> <p>(c) Operational Plan</p> <ul style="list-style-type: none"> <li>• Team overseeing the civil works Project Management</li> <li>• Project Schedule</li> <li>• Indicative BOQ for the Project</li> </ul> <p>(d) Financial Plan</p> <ul style="list-style-type: none"> <li>• Project Financing plan</li> <li>• 5-year financial forecasts</li> </ul>
	2.5.	Performance Guarantee
	2.6.	Clarifications related to the Due Diligence Declaration.
	2.7.	Other documents as reasonably requested by the Lessor for validation and verification of the proposal and for finalization of the terms of the Final Agreement
	2.8.	Completion of any required registration or re-registration of the Proponents business entity (if eligible)
	2.9.	Submission of any other regulatory clearance or documents from any local authorities as may be required prior to signing of the Final Agreement

## **SECTION V – ANNEXES AND FORMS**

---

The following Annexes are the sample format and forms required during the RPF process, for submission of the proposal and for the signing of the Final Agreement.

Where required the Proponent should use the formats given for submission of the required data along with the inclusion of any additional details as required for the submission or in support of the Proponents proposal.

## **Annex 1 – Project Location and Development Guidelines**

---



## LOCATION MAP

PROJECT : MIXED-USE PARKING BUILDING

SCALE : N.T.S

DRAWN BY : MIS

CHECKED BY :

DATE : 01 NOV 2022

REMARKS :

DRAWING : LOCATION MAP

REVISION:

DWG NO.:

1/2



MALE CITY COUNCIL

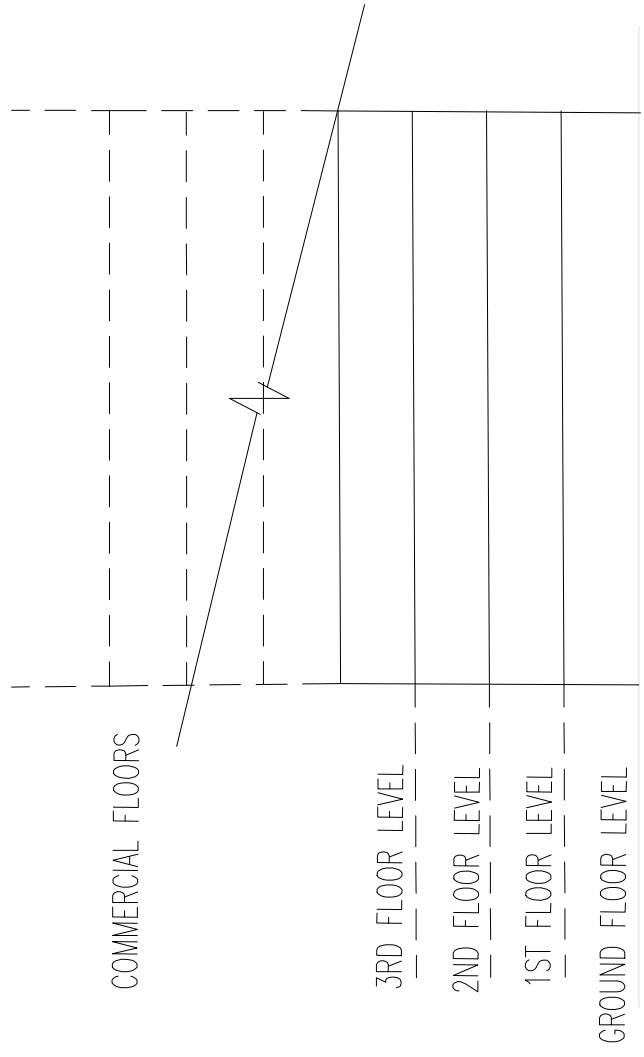
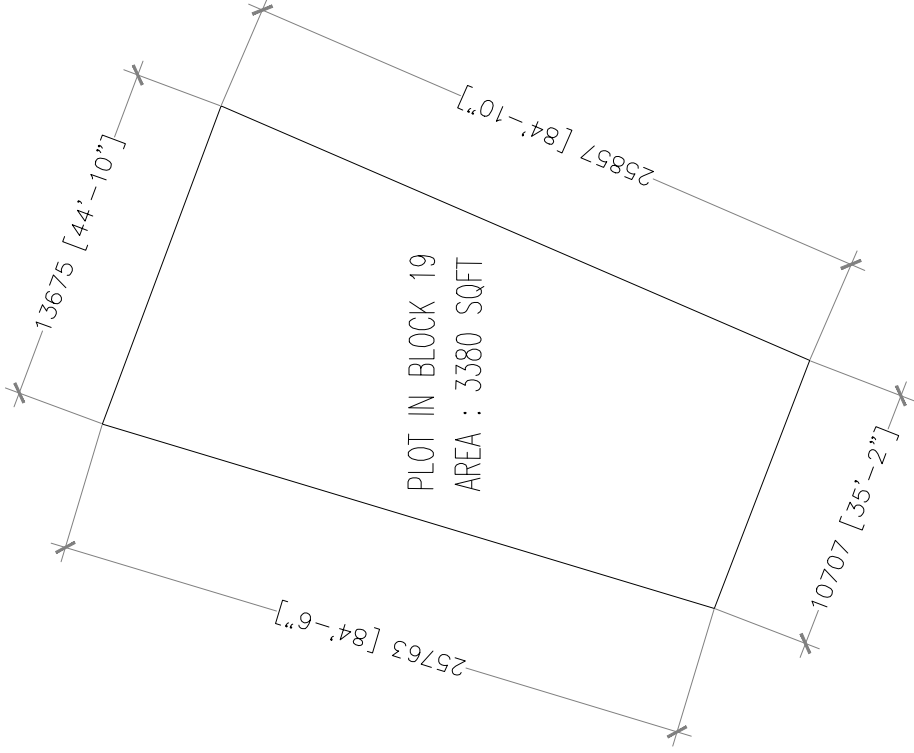

## PLOT MAP

## CONCEPTUAL ELEVATION

<b>PROJECT : MIXED-USE PARKING BUILDING</b>		DRAWING : PLOT MAP CONCEPTUAL ELEVATION		REVISION:		DWG NO.:	
SCALE : N.T.S	DRAWN BY : MIS	CHECKED BY :	DATE : 01 NOV 2022	REMARKS :			



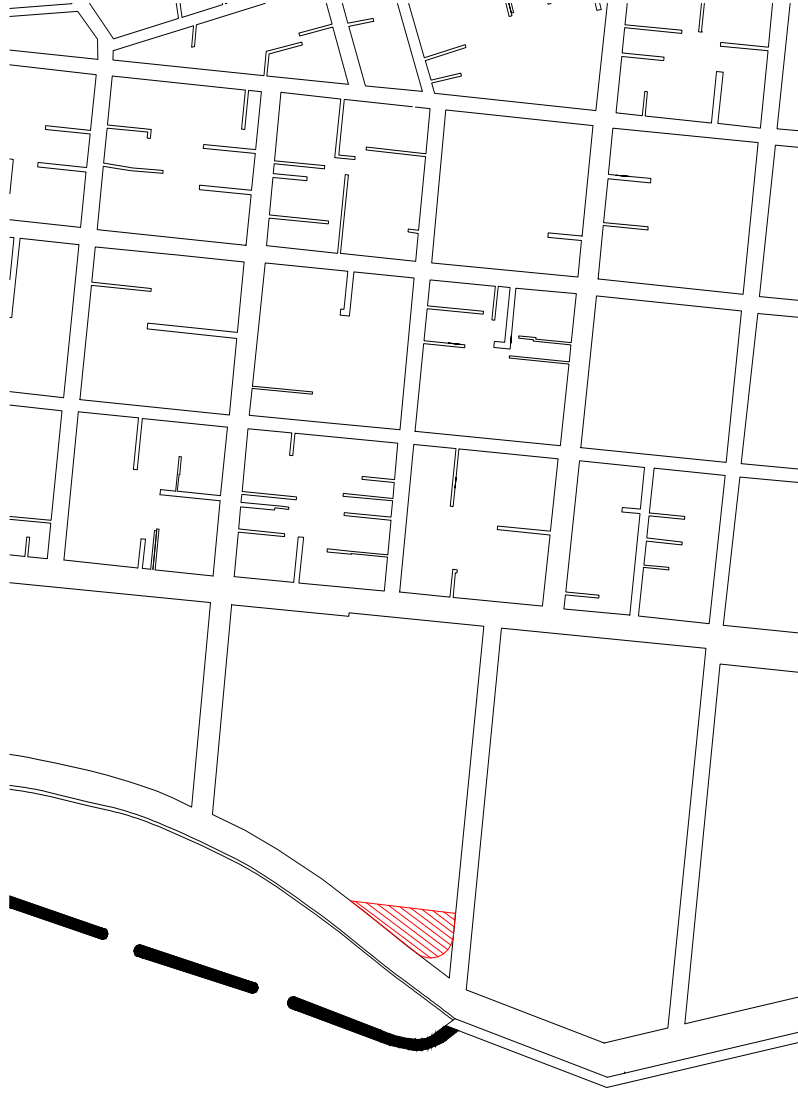
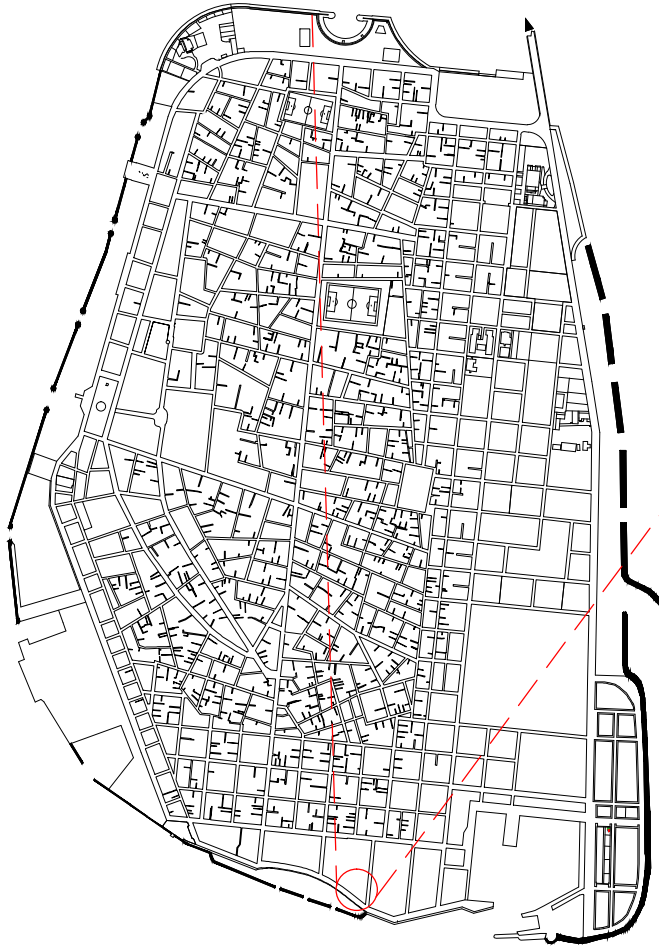

# LOCATION MAP

PROJECT : MIXED-USE PARKING BUILDING

SCALE : N.T.S

DRAWN BY : MIS

CHECKED BY :

DATE : 01 NOV 2022

REMARKS :

DRAWING : LOCATION MAP

REVISION:

DWG NO.:

1/2



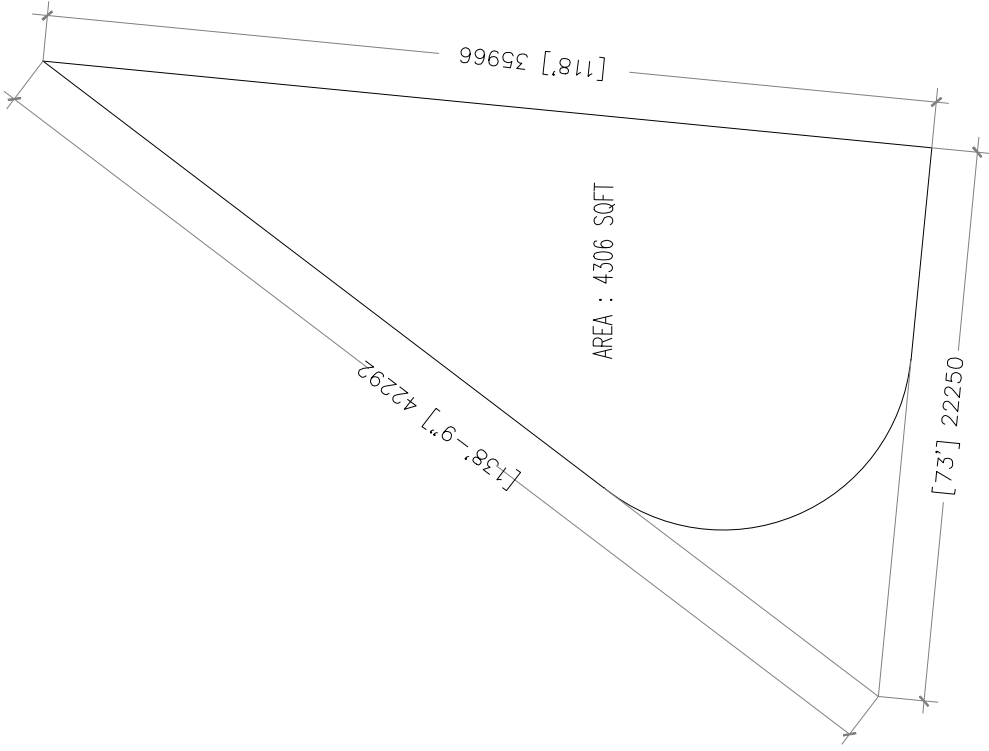

## PLOT MAP

## CONCEPTUAL ELEVATION

TERRACE	COMMERCIAL
4TH FLOOR LEVEL	COMMERCIAL
3RD FLOOR LEVEL	COMMERCIAL
2ND FLOOR LEVEL	COUNCIL OFFICE
1ST FLOOR LEVEL	PARKING
GROUND FLOOR LEVEL	PARKING

PROJECT : MIXED-USE PARKING BUILDING

SCALE : N.T.S

DRAWN BY : MJS

CHECKED BY :

DATE : 01 NOV 2022

REMARKS :

DRAWING : LOCATION MAP

REVISION:

DWG NO.:

2/2





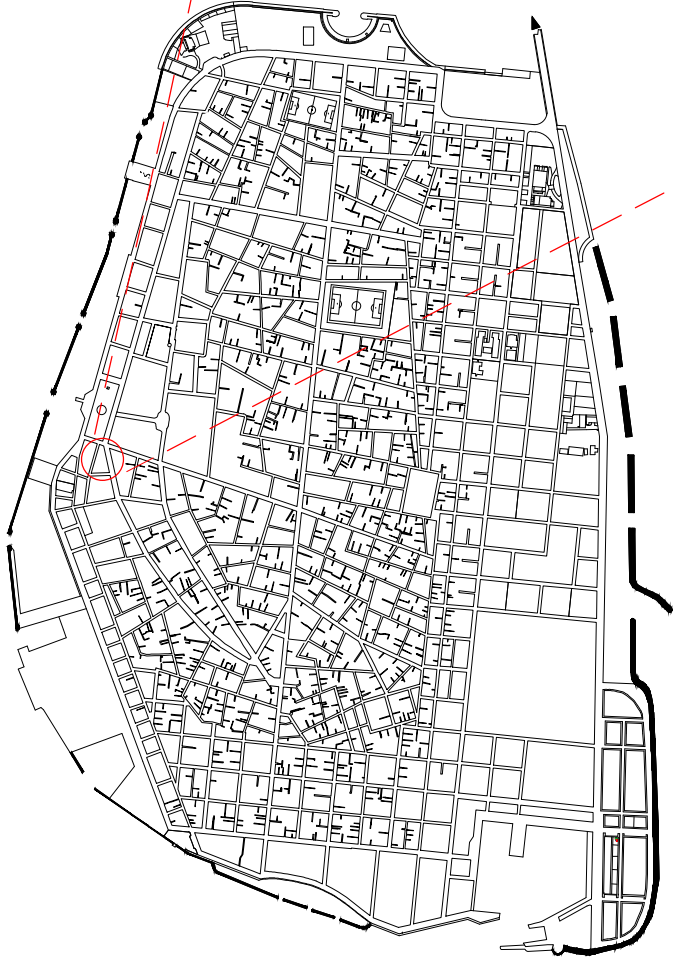

## LOCATION MAP

PROJECT : MIXED-USE PARKING BUILDING

SCALE : N.T.S

DRAWN BY : MJS

CHECKED BY :

DATE : 01 NOV 2022

DRAWING : LOCATION MAP

REVISION:

DWG NO.:

1/2



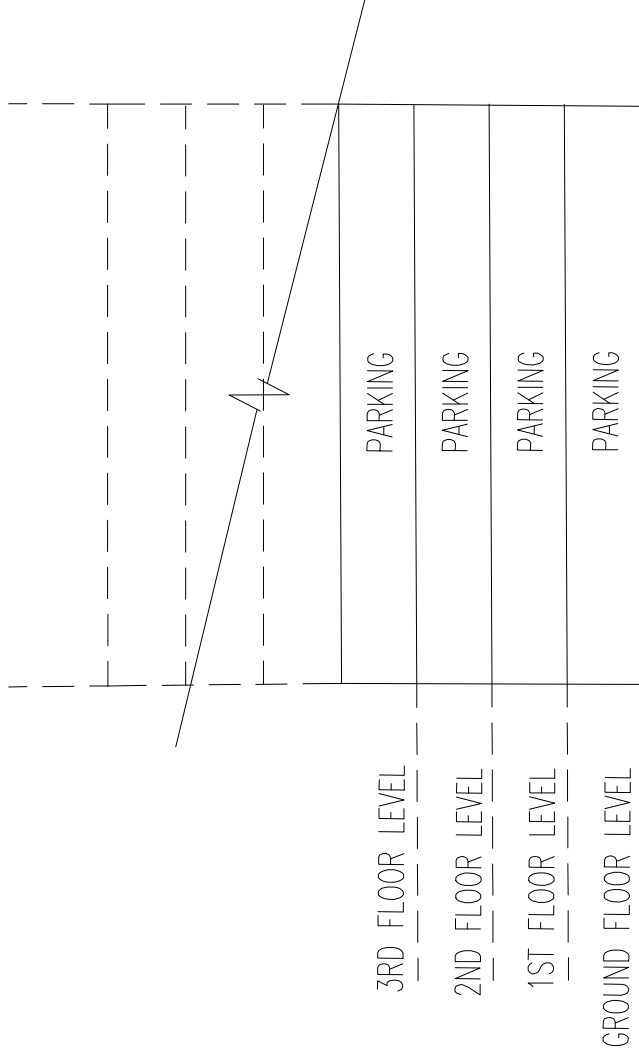
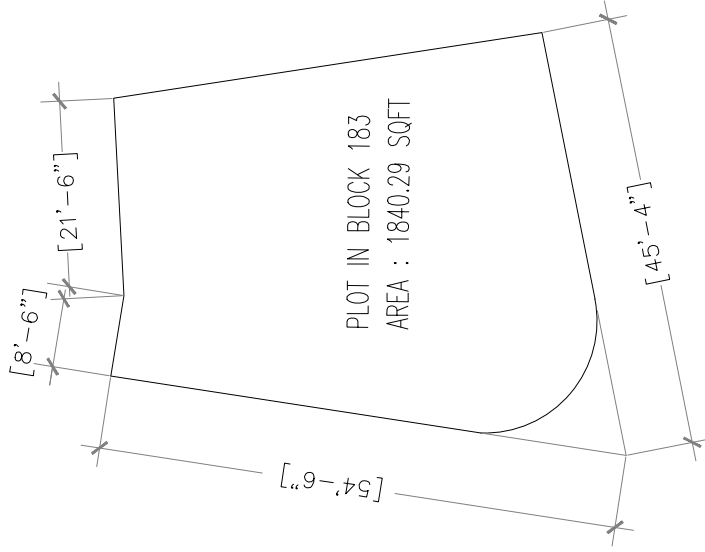

## PLOT MAP

## CONCEPTUAL ELEVATION

PROJECT : MIXED-USE PARKING BUILDING

SCALE : N.T.S

DRAWN BY : MJS

CHECKED BY :

DATE : 01 NOV 2022

REMARKS :

DRAWING : LOCATION MAP

REVISION:

DWG NO.:

2/2



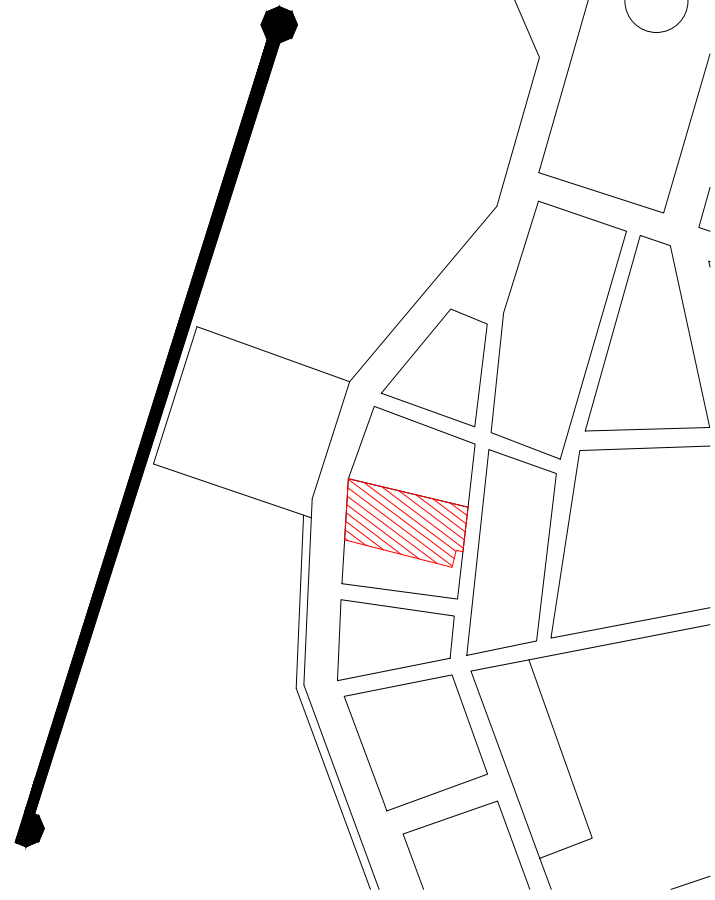
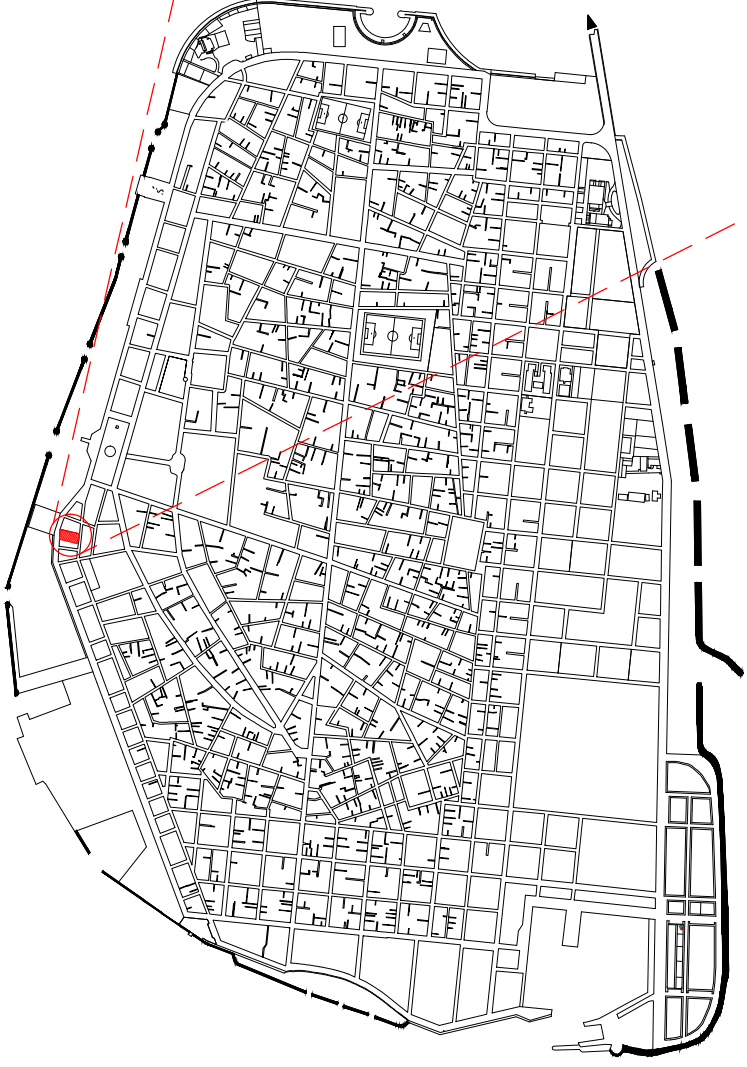

# LOCATION MAP

PROJECT : MIXED-USE PARKING BUILDING

SCALE : N.T.S

DRAWN BY : MJS

CHECKED BY :

DATE : 01 NOV 2022

REMARKS :

DRAWING : LOCATION MAP

REVISION:

DWG NO.:

1/2



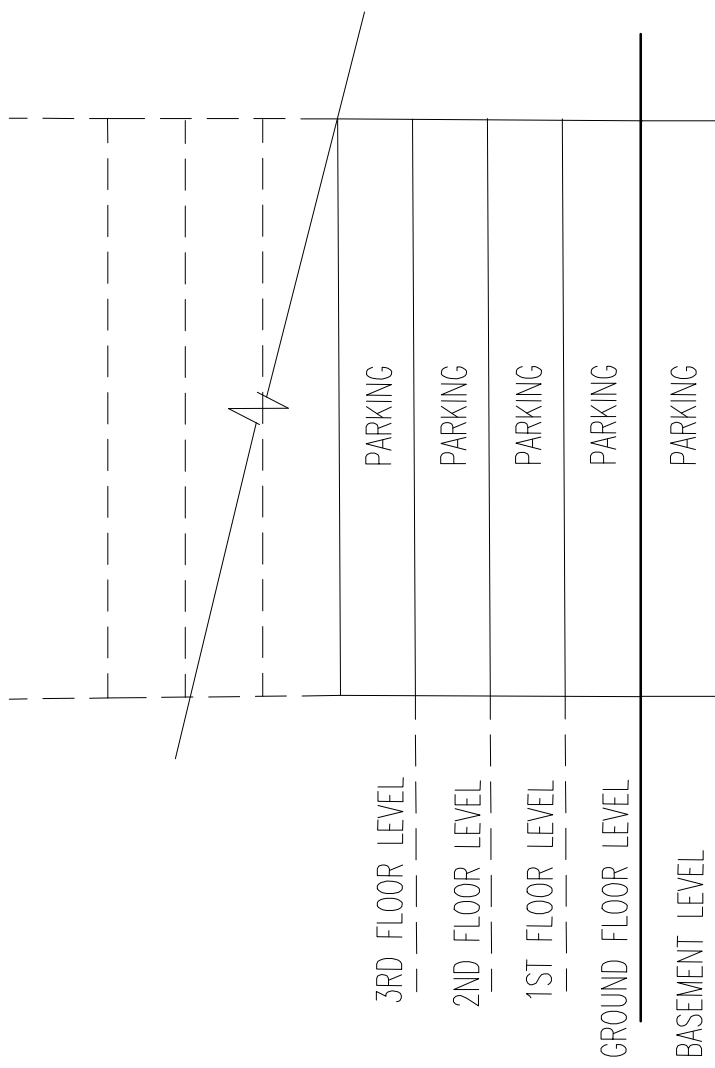
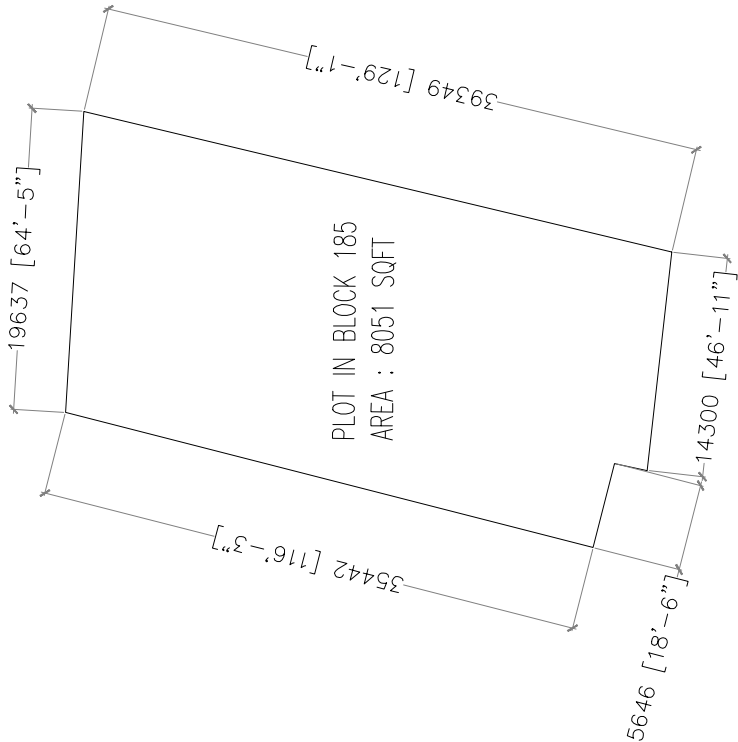

BALANCE ARE INVESTOR'S FLOORS

## PLOT MAP

## CONCEPTUAL ELEVATION

PROJECT : MIXED-USE PARKING BUILDING		DRAWING : LOCATION MAP	REVISION:	DWG NO.:
SCALE : N.T.S	DRAWN BY : MJS	CHECKED BY :	REMARKS :	2/2
DATE : 01 NOV 2022				



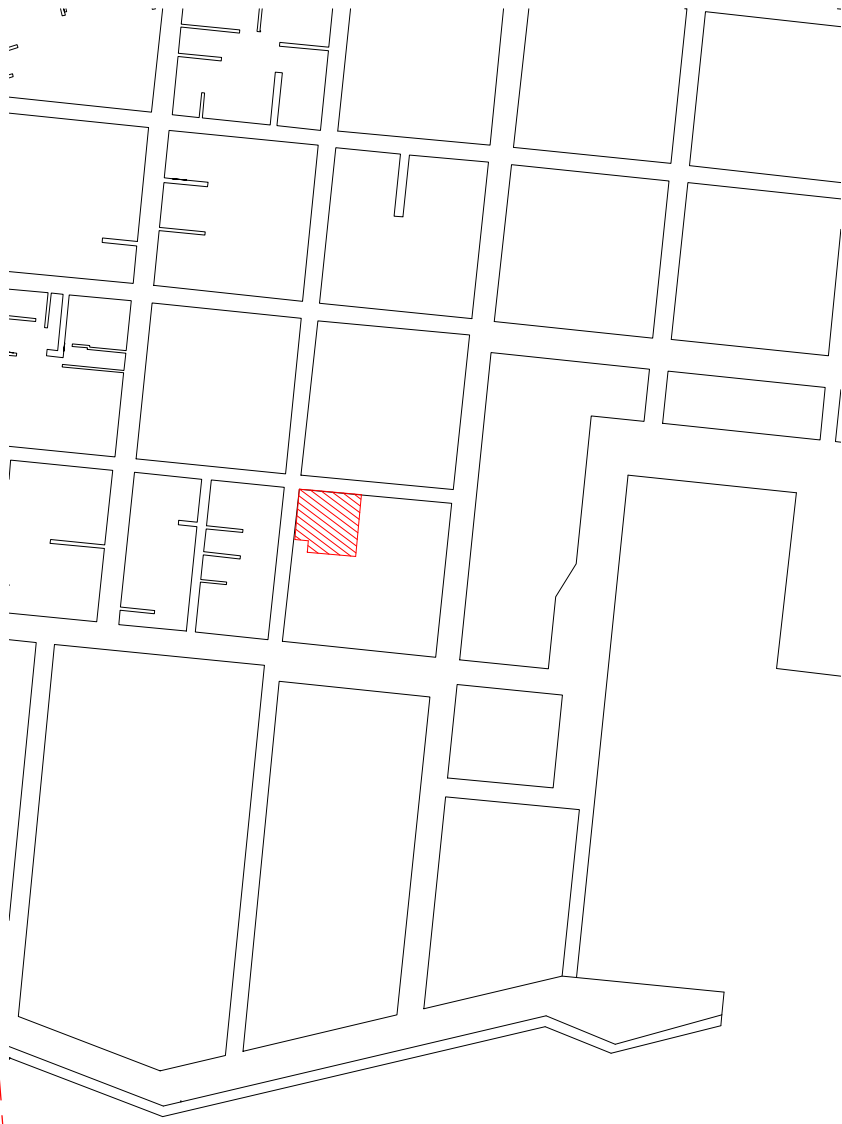
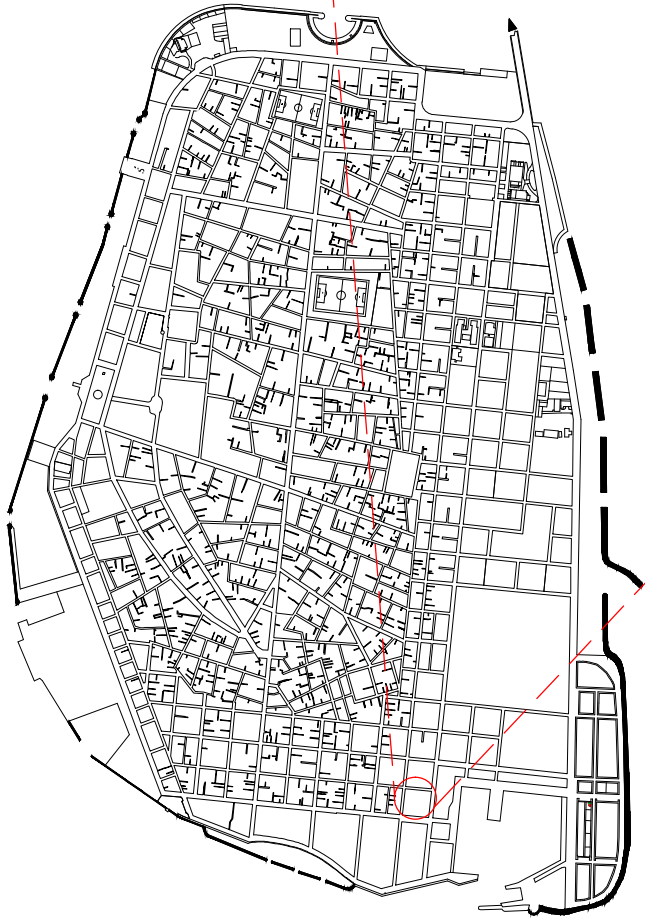

## LOCATION MAP

PROJECT : MIXED-USE PARKING BUILDING

SCALE : N.T.S

DRAWN BY : MJS

CHECKED BY :

DATE : 01 NOV 2022

DRAWING : LOCATION MAP

REVISION:

DWG NO.:

1/2

REMARKS :



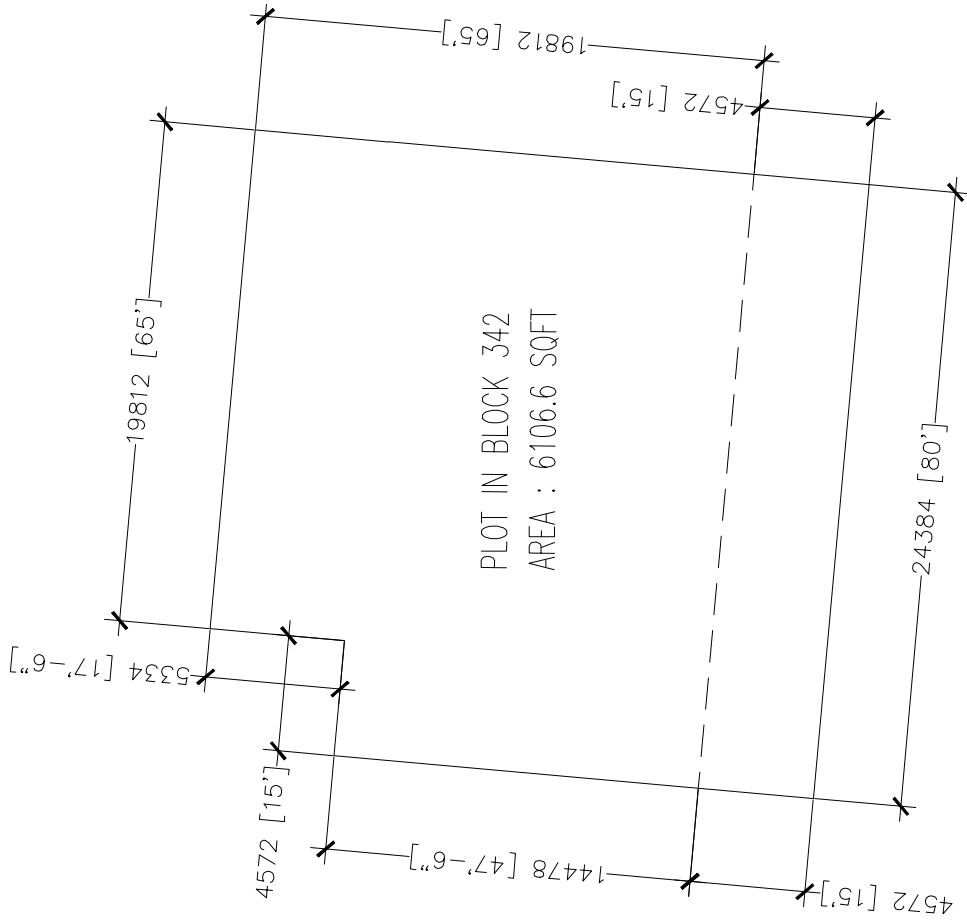

## PLOT MAP

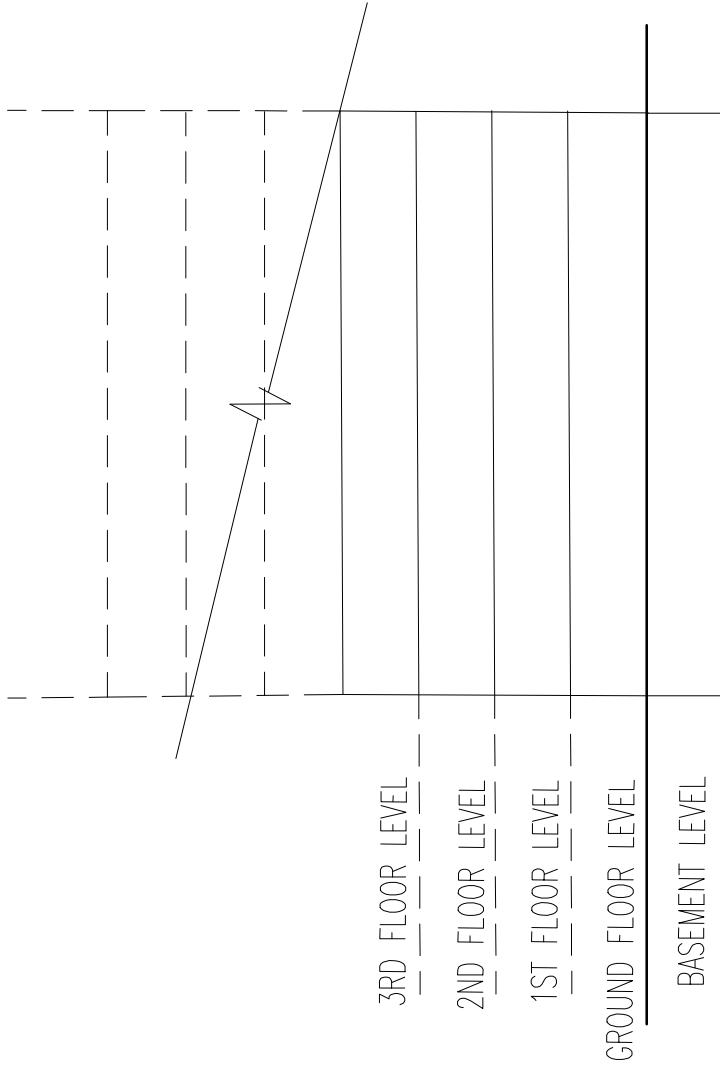

## CONCEPTUAL ELEVATION

PROJECT : MIXED-USE PARKING BUILDING		DRAWING : PLOT MAP CONCEPTUAL ELEVATION		REVISION:	DWG NO:	 Multi City Council
SCALE : N.T.S	DRAWN BY : MIS	CHECKED BY :	DATE : 01 NOV 2022	REMARKS :	2/2	

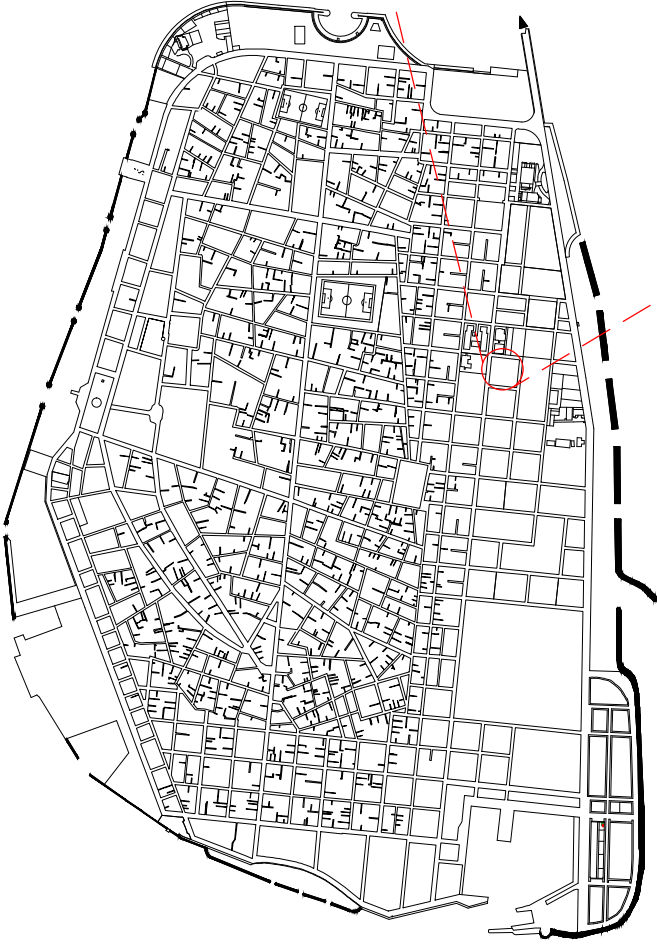

## LOCATION MAP

PROJECT : MIXED-USE PARKING BUILDING

SCALE : N.T.S

DRAWN BY : MJS

CHECKED BY :

DATE : 01 NOV 2022

REMARKS :

DRAWING : LOCATION MAP

REVISION:

DWG NO.:

1/2



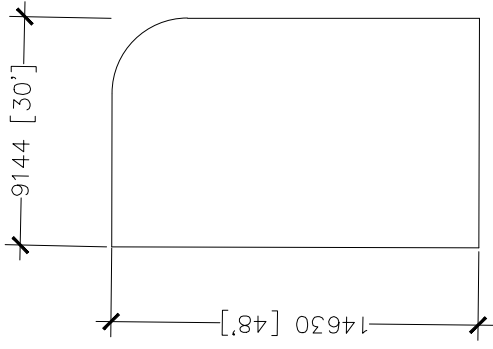

## PLOT MAP

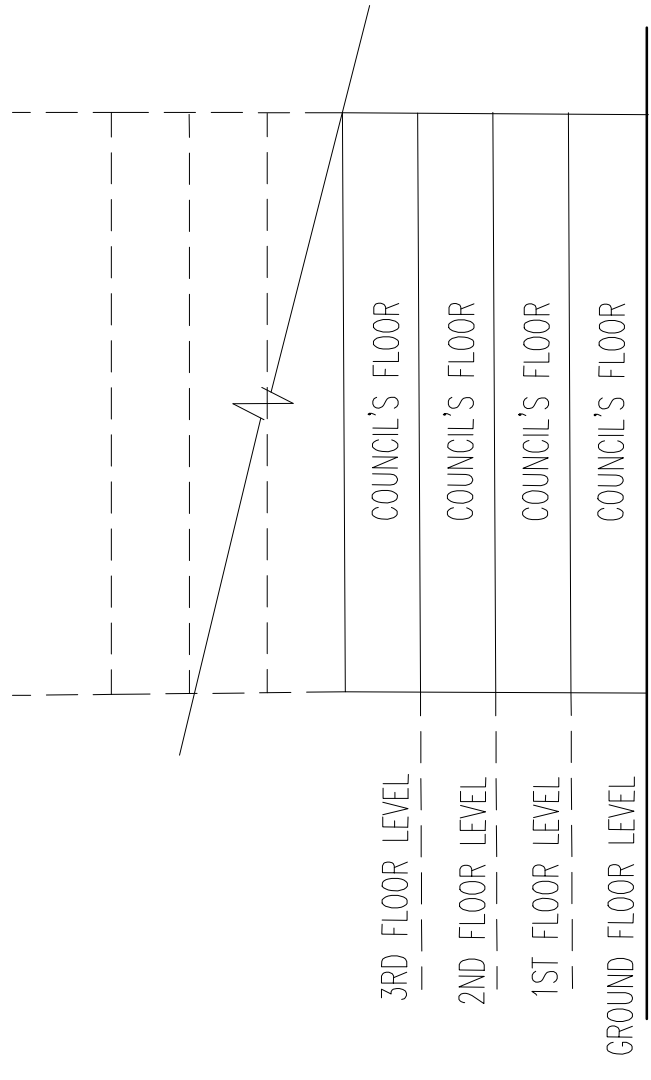

BALANCE ARE INVESTOR'S FLOORS

## CONCEPTUAL ELEVATION

PROJECT : MIXED-USE PARKING BUILDING		DRAWING : PLOT MAP CONCEPTUAL ELEVATION	REVISION:	DWG NO.: <b>2/2</b>	
SCALE : N.T.S	DRAWN BY : MJS	CHECKED BY :	DATE : 01 NOV 2022	REMARKS :	



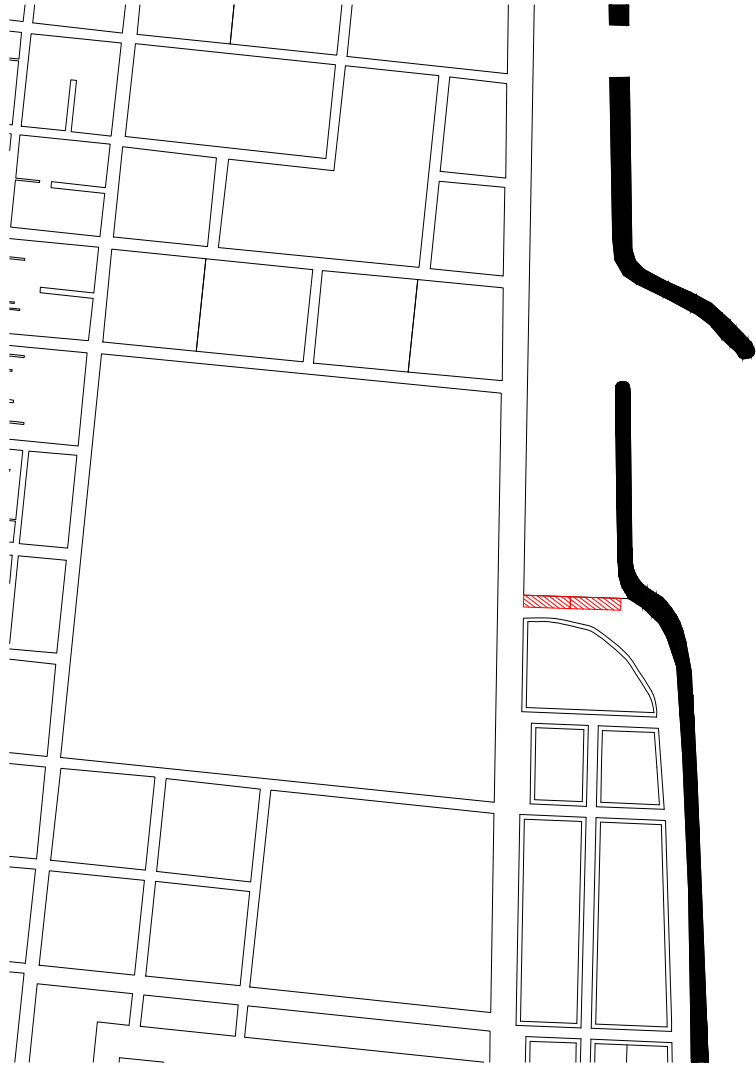
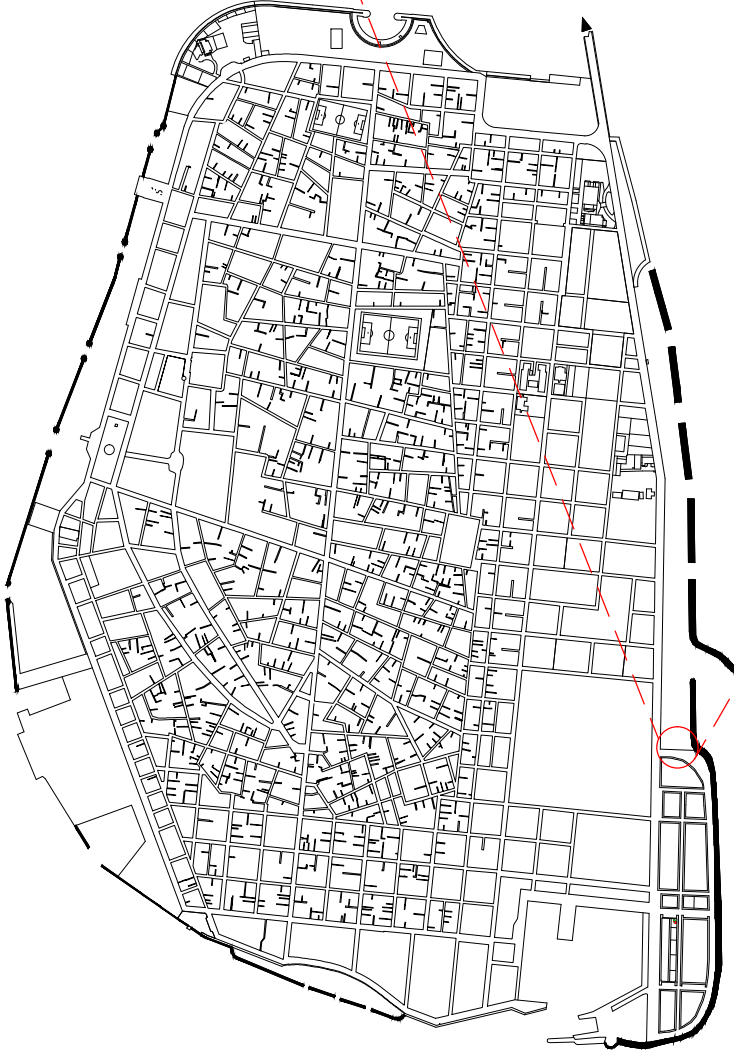

# LOCATION MAP

PROJECT : MIXED-USE PARKING BUILDING		DRAWING : LOCATION MAP	REVISION:	DWG NO:	 3-0-01-01-02 3-0-01-01-02 3-0-01-01-02
SCALE : N.T.S	DRAWN BY : MJS	CHECKED BY :	DATE : 01 NOV 2022	REMARKS :	

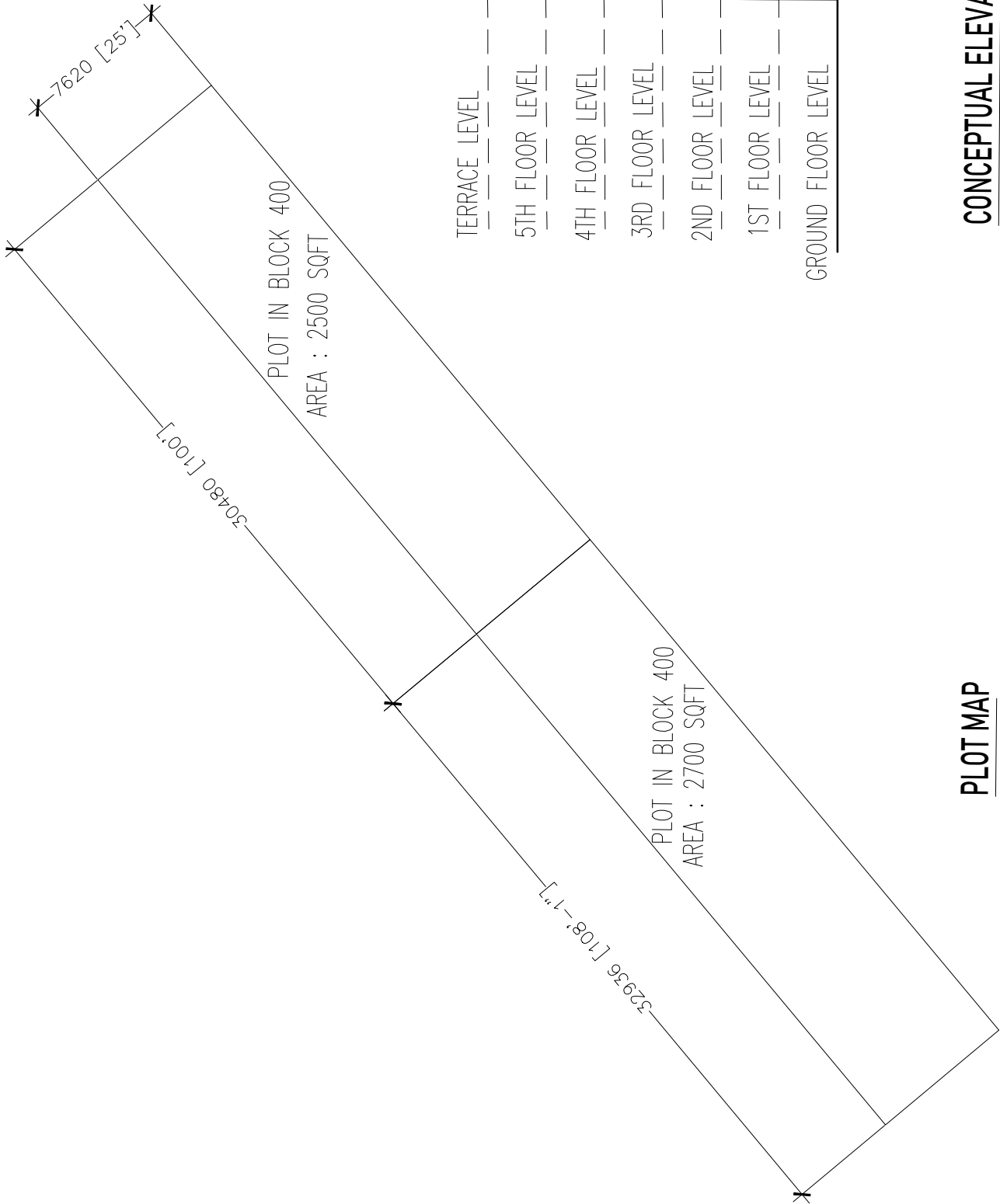

PLOT IN BLOCK 400  
AREA : 2500 SQFT

PLOT IN BLOCK 400  
AREA : 2700 SQFT

TERRACE LEVEL	
5TH FLOOR LEVEL	
4TH FLOOR LEVEL	
3RD FLOOR LEVEL	
2ND FLOOR LEVEL	
1ST FLOOR LEVEL	
GROUND FLOOR LEVEL	GROUND FLOOR LEVEL

### PLOT MAP

### CONCEPTUAL ELEVATION

<b>PROJECT : MIXED-USE PARKING BUILDING</b>		<b>DRAWING : PLOT MAP</b>		<b>DWG NO.:</b>	
SCALE : N.T.S		CONCEPTUAL ELEVATION		2/2	
DRAWN BY : MJS		REVISION:		REVISION:	
CHECKED BY :		REMARKS :		REMARKS :	
DATE : 01 NOV 2022					



2022 11 01  
MJS  
MJS CITY CONSULT

## Form 1 – Registration form for Proposal Submission

---

# REGISTRATION FOR PROPOSAL SUBMISSION

## 1. PROPONENT / BUSINESS NAME

## 2. BUSINESS REGISTRATION NUMBER

## 3. REGISTERED BUSINESS ADDRESS

## 4. CONTACT PERSON

## 5. CONTACT NUMBER

## 6. CONTACT EMAIL

## 7. RFP REREFERENCE NUMBER

## 8. PROJECT NAME

## PROPONENTS DECLARATION

We, the Proponent/Business as given above wish to register our interest to take part in the submission for the RFP for the above given project and the contact point and contact details as given above shall be the primary contact up to the RFP Submission.

## SIGNATURE & STAMP

Date: .....

## Form 2 – Proposal Cover Page Format

---

# PROPOSAL COVER PAGE

It is the responsibility of the Proponent to ensure that the documents listed below are enclosed as the first page of the Proposal document subsequent to which the Proponent may enclose the proposal.

PROPONENT AND PROJECT DETAILS		
Proponent / Business Name:		
RFP Reference Number:		
Project Name:		
Plot No. (if applicable):		
DOCUMENTS CHECKLIST		
Checked by:		
Proponent	Lessor	
		Proposal Cover Page
		Proposal Submission Form
		Bid Security Draft with signed declaration
		Signed Partnership Term sheet if Proponents wish to form a partnership
		Business Registration Copy
		Company Profile
		Project References
		MOA of the Proponent
		AOA of the Proponents
		Comfort Letters from financial institutions if project is to be undertaken from Borrowings
		Board Resolution from Directors if project is to be implemented from Proponents own funds
		Draft Concept design
		Audited Financial Statements for past 3 years or Management Accounts for the most recent year
		Signed Due Diligence Declaration
		Power of Attorney authorizing Proponents representative to sign and submit proposal
		Any revisions to the registered email or authorized contact person who will represent the Proponent

## PROPONENTS DECLARATION

We confirm that we have enclosed the above list of documents along with the proposal and understated that the proposal may be disqualified if the documents are not in accordance with the RFP Proposal Requirements.

Name: .....

Designation: .....

.....

**SIGNATURE & STAMP**

Date: .....

## Form 3 – Proposal Summary Form

---

# PROPOSAL SUMMARY FORM

We, the undersigned, declare that:

1. We have examined and have no reservations to the Request for Proposal (RFP) documents including all addenda issued in accordance with Instruction to Proponents (ITP) 6.
2. We meet the eligibility requirements and have no conflict of interest in accordance with ITP 3.
3. We have no outstanding payment due to the Lessor.
4. We have no non-performance of a contract and non-compliance with court verdicts.
5. Our proposal shall be valid for the period as specified in ITP 13. from the date of proposal submission in accordance with RFP document and it shall remain binding upon us and may be accepted at any time before the expiration of that period.
6. We understand that this proposal, together with your written acceptance thereof included in your notification of award, shall constitute a binding contract between us, until a formal contract is prepared and executed; and
7. We understand that Lessor is not bound to accept the highest evaluated proposal or any proposal that may receive.
8. Accordingly, we shall furnish all the required detailed documents as may be pertinent to the evaluation process, and the summary of our proposal and terms are as proposed below:

1. PROPONENT AND PROJECT DETAILS		
Proponent / Business Name:		
Proponent Registered Address:		
Proponent Registration Number:		
RFP Reference Number:		
Project Name:		
Plot No. (if applicable):		
2. PROPOSED RENT		
We undertake to pay the rent as per Section II, 1. of the RFP, and our offer of rent for the first 05 (five) years, per square feet, per month, for the Project location, are as follows:		
Year	Amount in numbers (MVR) / month / sq.ft	Amount in Words in Maldivian Rufiyaa per month per square feet
Year 1	Amount in numbers	Amount in words
Year 2	Amount in numbers	Amount in words
Year 3	Amount in numbers	Amount in words
Year 4	Amount in numbers	Amount in words
Year 5	Amount in numbers	Amount in words
3. DEVELOPMENT COST		
Estimated total project cost for parking floors (excluding Proponents commercial floors) in Maldivian Rufiyaa is:	Amount in numbers:	Amount in numbers
	Amount in Words:	Amount in words
4. LEASE PERIOD		
We propose to lease the development to us for a total lease period (excluding any development and/or grace period) for a total duration in number of years total of:		Total number of years



**5. DESIGN CONCEPT**

Our design concept for the proposed development is summarized below and the final detailed designs, unless otherwise agreed with the Lessor, shall conform to the requirements as described below. I understand that the Lessor may reject the proposed design if it is not in conformity with the requirement of the Lessor.

A brief description of the design concept for the project highlighting any points that the Proponent wishes to take note

**6. PROPOSED TOTAL GFA AND FLOORS TO BE HANDED OVER TO LESSOR**

We propose our development to consist of a total GFA as follows:	Total approximate GFA in sq.ft. of total project
We propose to hand over the following floors to the Lessor on completion of the Project:	Floors Numbers (i.e., basement, ground, first, ... etc)
Estimated GFA of the floors to be handed over to Lessor as proposed above is (total sq.ft.):	Total GFA in sq.ft. of floors for Lessor

**7. CAPACITY OF THE PROPONENT**

A brief description of the Proponents capacity to undertake the project highlighting any financial, technical and background details of the Proponent that maybe pertinent to the verification of the Proponents capacity to undertake the project

**8. ADDITIONAL INFORMATION**

Any additional information that that the Proponent wishes to highlight in support of the Proponents proposal

**PROPONENTS DECLARATION**

We confirm that we have enclosed the above list of documents along with the proposal and understated that the proposal may be disqualified if the documents are not in accordance with the RFP Proposal Requirements.

Name: .....

Designation: .....

**SIGNATURE & STAMP**

Date: .....

## **Form 4 – Power of Attorney to Sign and Submit Proposal**

---

The Proponent may utilize their own format of the Board Resolution for assignment of the Power of Attorney, but the following information and points should be included in the Board Resolution submitted with the Proposal

- Project RFP Number
- Project Name
- Plot Number (if applicable)
- Details of the receiver of Power of Attorney (Name and Identification details)
- Contact details of the Power of Attorney with email and contact number
- Rights of the Power of Attorney (signatory only, signatory and representation ... etc)

The Board Resolution assigning the Power of Attorney should be signed by the quorum of the Directors of the Company and should comply with all other requirements of the Articles and legal requirements for compliance as a valid Power of Attorney.

## Form 5 – Board Resolution Sample

---

The Proponent may utilize their own format of the Board Resolution for confirmation of intention to participate in the RFP, but the following information and points should be included in the Board Resolution submitted with the Proposal

- Proponent Details covering Proponent registered name, registered address and registration number
- Project RFP Number
- Project Name
- Plot Number (if applicable)
- Confirmation of intention to participate in the RFP and to be bound by the requirements of the RFP and acceptance of the RFP outcome

The Board Resolution should be signed by the quorum of the Directors of the Company and should comply with all other requirements of the Articles and legal requirements for compliance as a valid Board Resolution of the Company.

## Form 6 – Bid Security Sample with Declaration

---

## Form 6 – Bid Security Sample with Declaration

---

The Issuing Bank shall fill in this Bank Security Form in accordance with the instructions indicated.

..... [Bank's Name, and Address of Issuing Branch or Office]

**Beneficiary:** Male' City Council,, 3rd Floor, MWSC Customer Services Building, Ameenee Magu, Malé, Republic of Maldives,

**Date:** .....

**Bid Security No:** .....

We have been informed that ..... [name of the proponent] (hereinafter called "the Proponent") has submitted their proposal dated ..... [date of proposal submission] for the execution of ..... [name of project] (hereinafter called "the Project") under Request for Proposal No. .... [request for proposal reference no.] hereinafter called "the RFP".

Furthermore, we understand that, according to your conditions, the Proposals must be supported by a Bid Security.

At the request of the Proponent, we ..... [name of Bank] hereby irrevocably undertake to pay you any sum or sums not exceeding in total an amount of ..... [amount in figures] ..... [amount in words] upon receipt by us of your first demand in writing accompanied by a written statement stating that the Proponent is in breach of its obligation(s) under the RFP conditions, because the Proponent:

- (a) has withdrawn its Proposal during the period of Proposal validity specified by the Proponent in the Letter of Proposal; or
- (b) having been notified of the acceptance of its Proposals by the Lessor during the period of Proposal validity,
  - (i) fails or refuses to pay lease deposit, or
  - (ii) fails to execute the terms and conditions of the Conditional Award of the Lessor.

This guarantee will expire: (a) if the Proponent is the successful Proponent, upon our receipt of copies of the agreement signed by the Proponent and the lease deposit furnished to you upon the instruction; and (b) if the Proponent is not the successful Proponent, upon the earlier of (i) our receipt of a copy of your notification to the Proponent of not being the successful Proponent; or (ii) **180 (One Hundred and Eighty)** calendar days from [date of submission] of this Bid Security in respect of the Proposal submitted for the RFP.

Consequently, any demand for payment under this guarantee must be received by us at the office on or before that date.

This guarantee is subject to the Uniform Rules for Demand Guarantees, ICC Publication No. 458

**[seal and signature of the bank / valid institution]**

## PROONENTS DECLARATION

We, the Proponent, confirm that we shall promptly furnish the Bid Security in the format as given above on receipt of the call for the Bid Security, and shall furnish the said Bid security from any one of the following entities, who are compliant with the eligibility of the RFP requirements for issuance of Bid Securities, and will submit the Bid Security within the time frame as required by the Lessor.

We further understand and accept that on our failure to furnish the said Bid Security as requested, the Lessor reserves the right to reject and disqualify our Proposal.

Proposed Banks: .....

Name: .....

Designation: .....

**SIGNATURE & STAMP**

**Date:** .....

## Form 7 – Summary of Business Plan

---

# SUMMARY OF BUSINESS PLAN

We, the undersigned, declare that:

1. We have examined the Lessors requirements for the Project as stipulated in Section III of the RFP and have undertaken our detailed assessments for the Project based on the requirements.
2. Should our proposal be accepted, we shall be undertaking the Project within the overall project management and implementation framework as summarized below.
3. The summaries as presented below shall form the basis for our detailed business plan for the Projects which shall be made available to the Lessor when called for.
4. Accordingly, we furnish a summary of our proposed business plan for the project for your review.

1. PROPONENT AND PROJECT DETAILS	
Proponent / Business Name:	
Proponent Registration Number:	
RFP Reference Number:	
Project Name:	
Plot No. (if applicable):	
2. OUTLINE OF THE PROJECT	
<p>A summary of the Proponents plan for the project covering the overall scope, design details and overall objectives for the project as planned for by the Proponent</p>	
3. MANAGEMENT AND HR PLAN	
<p>A summary of the Proponents overall plan for the management of the created asset covering the staffing and management requirements for the project.</p>	



#### 4. MARKETING PLAN

A summary of the Proponents plans to market and generate revenue from the asset, covering components such as the pricing and marketing strategy for the components developed under the asset. The summary should cover relevant details such as the target segments, promotional strategies, and overall products and services to be provided through the development of the asset.

#### 5. OPERATIONAL PLAN

A summary of the Proponents overall project development and project implementation covering key components of the planned civil works. Summaries of the project management and civil works team, including construction approach may be detailed here. A summary project schedule and an indicative BOQ should be submitted along with any other summary details.

#### 6. FINANCIAL PLAN

A summary of the Proponents financial plan for the implementation and operation of the asset. The summary should provide the project funding/financing strategy, and highlights of the 5-year financial forecasts for the project along with any other financial details the Proponent may wish to submit at this stage.

### **PROPOSERS DECLARATION**

---

We confirm that the above details are a summary of the contents of the business plan for the project to be developed under the RFP and will submit the detailed business plan in line with the above summary when requested for by the Lessor.

Name: .....

Designation: .....

.....

**SIGNATURE & STAMP**

Date: .....

## **Form 8 – Due Diligence Declaration**

---

The Proponent is to use whichever of the forms is applicable to the Proponent based on the applicability to the Proponent.

The Lessor may seek further clarification on the details given in the Declaration and the Lessor reserves the right to disqualify any proposal if the Lessor finds any false details presented in the Declaration.

# DUE DILIGENCE DECLARATION

## Format 1 - Declaration of Existence of Pending, Threatened or Ongoing Litigations

### Re: Declaration of Pending or Threatened Litigations

The following is the list of all ongoing public and/or private litigation, suit, proceeding investigation, adjudication, arbitration and governmental proceedings wherein we, the Proponent and/or our Directors is or likely to be a party, or which is threatened against any of us, or for which there are ongoing responsibilities of any of us.

No	Claimant	Defendant	Brief Description of Claim

I hereby declare that, except for the above, there is no action, suit, proceeding, investigation, adjudication, arbitration, or litigation pending or, to our knowledge, threatened, which either in any one instance or in the aggregate, if determined adversely to us would materially and adversely affect the execution or progression of the Project, or our ability to perform the obligations under the Agreement for the execution of the Project.

### PROPONENTS DECLARATION

I hereby declare under penalty of perjury that the foregoing is true and correct.

Name: .....

Designation: .....

.....

**SIGNATURE & STAMP**

Date: .....

**Format 2 - Declaration of No Pending Litigation**

**Re: Declaration of No Pending Litigation**

I hereby declare that there is no action, suit, proceeding, investigation or litigation pending or, to our knowledge, threatened, which either in any one instance or in the aggregate, if determined adversely to us would materially and adversely affect the execution or progression of the Project, or our ability to perform our obligations under the Agreement for the execution of the Project.

**PROponents DECLARATION**

---

I hereby declare under penalty of perjury that the foregoing is true and correct.

Name: .....

Designation: .....

.....

**SIGNATURE & STAMP**

**Date:** .....