

## **Annex 1 – Project Location and Development Guidelines**

---



## LOCATION MAP

PROJECT : MIXED-USE PARKING BUILDING

SCALE : N.T.S

DRAWN BY : MIS

CHECKED BY :

DATE : 01 NOV 2022

REMARKS :

DRAWING : LOCATION MAP

REVISION:

DWG NO.:

1/2



ދިވެހިރާއްޖޭގެ ޖުމްހޫރިއްޔާ  
މާލެ ސިޓީ ބައްލަވާލައްވާ  
MALÉ CITY COUNCIL

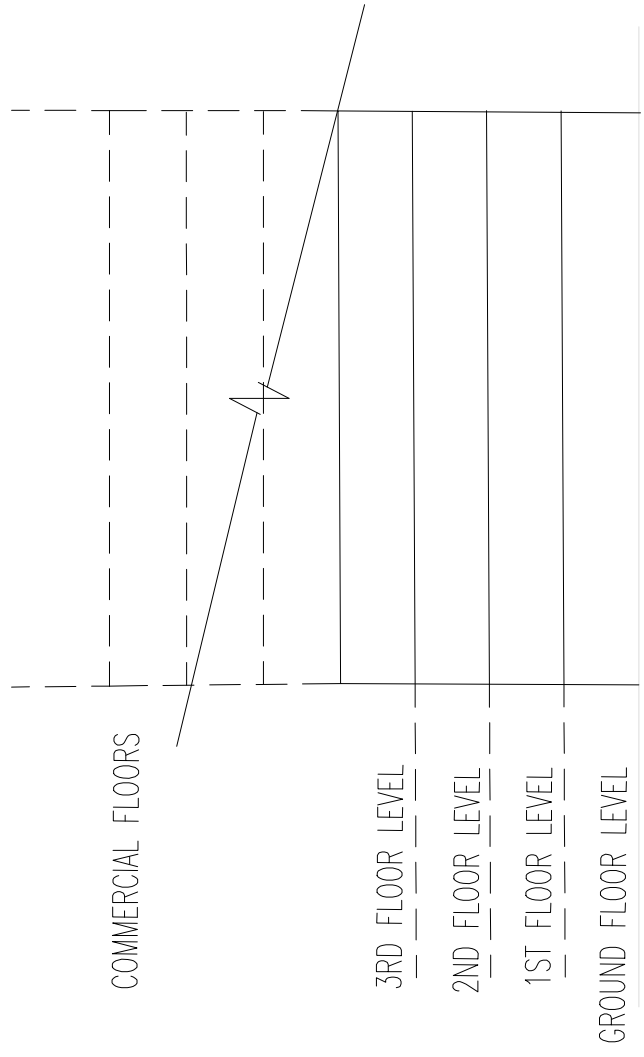
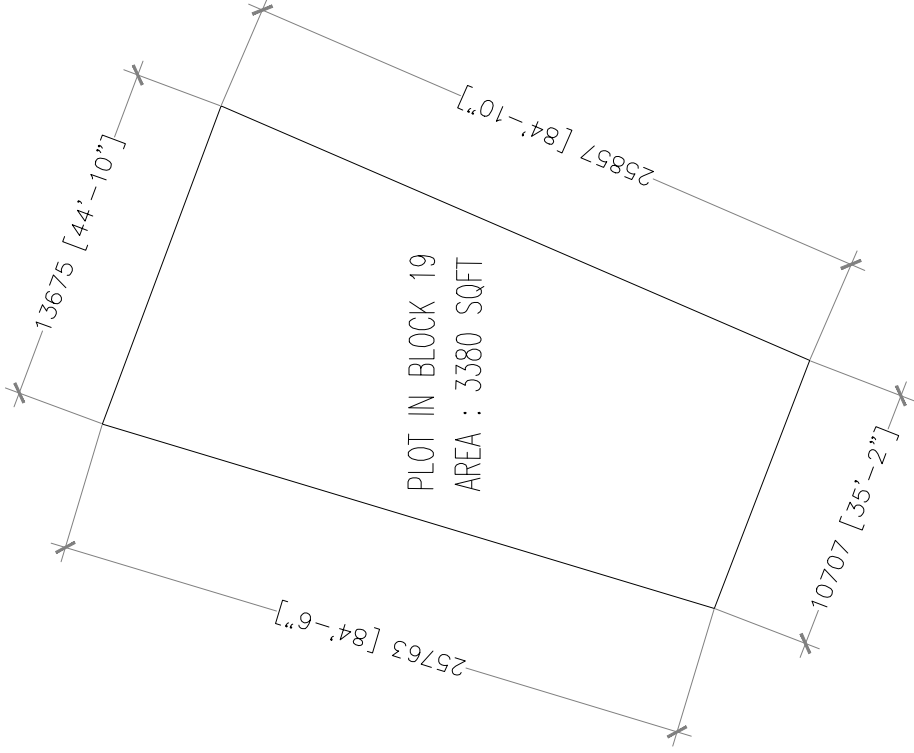

## PLOT MAP

## CONCEPTUAL ELEVATION

<b>PROJECT : MIXED-USE PARKING BUILDING</b>		DRAWING : PLOT MAP CONCEPTUAL ELEVATION		REVISION:	DWG NO.:
SCALE : N.T.S	DRAWN BY : MIS	CHECKED BY :	DATE : 01 NOV 2022	REMARKS :	



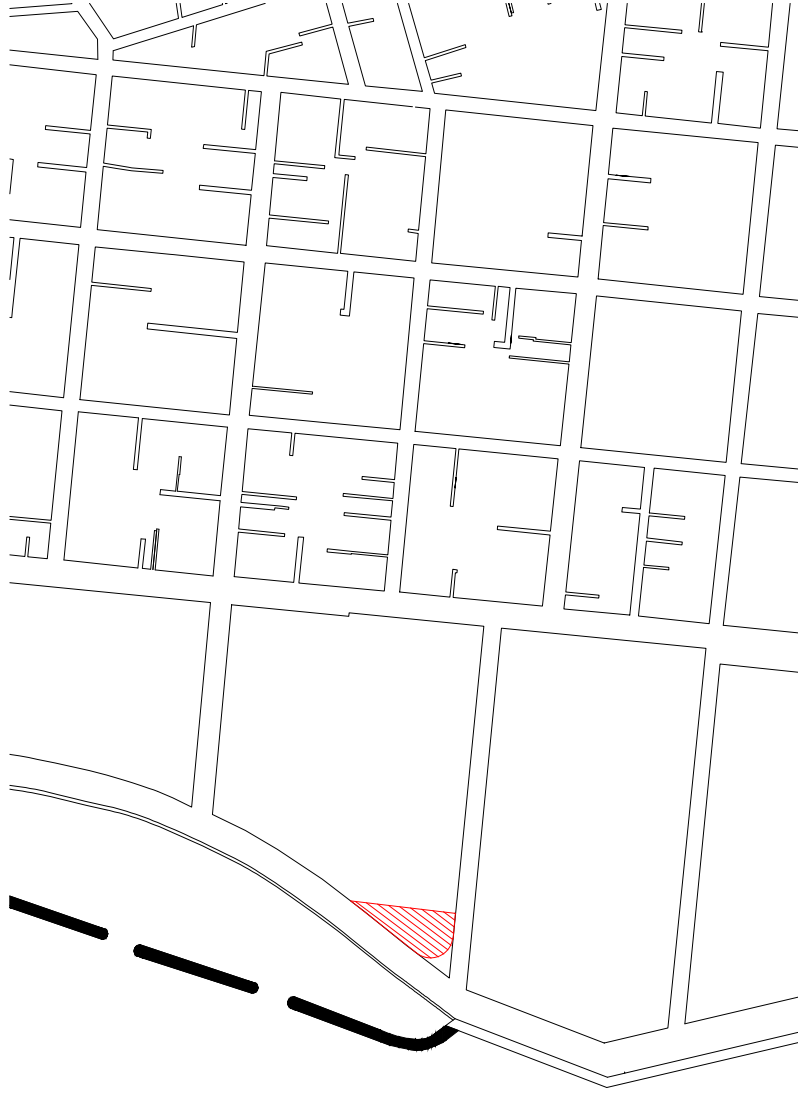
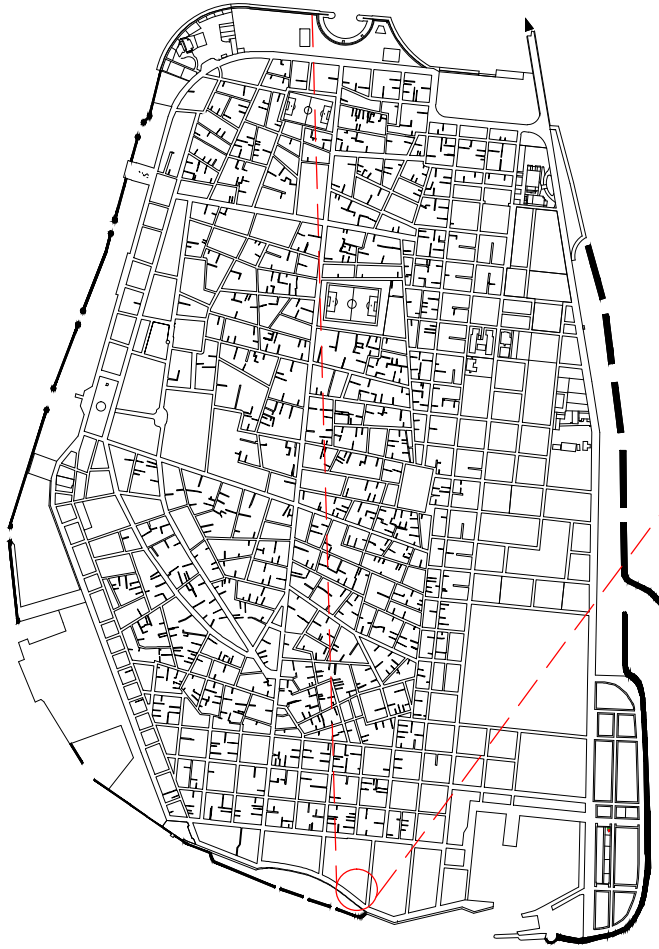

# LOCATION MAP

PROJECT : MIXED-USE PARKING BUILDING

SCALE : N.T.S

DRAWN BY : MIS

CHECKED BY :

DATE : 01 NOV 2022

REMARKS :

DRAWING : LOCATION MAP

REVISION:

DWG NO.:

1/2



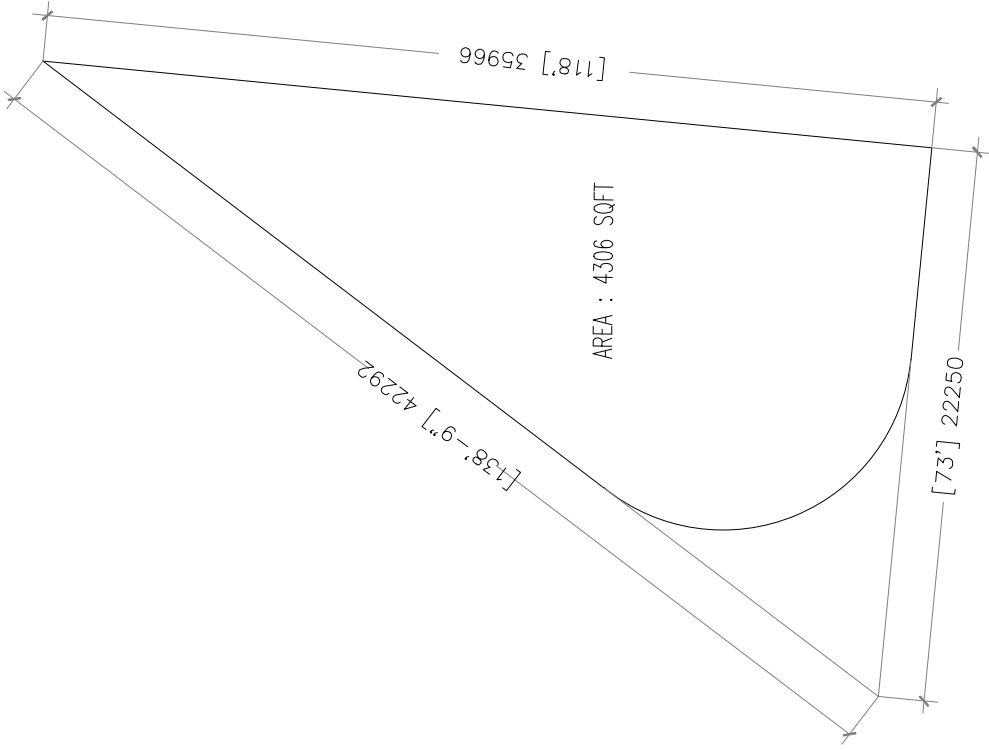

## PLOT MAP

## CONCEPTUAL ELEVATION

TERRACE	COMMERCIAL
4TH FLOOR LEVEL	COMMERCIAL
3RD FLOOR LEVEL	COMMERCIAL
2ND FLOOR LEVEL	COUNCIL OFFICE
1ST FLOOR LEVEL	PARKING
GROUND FLOOR LEVEL	PARKING

PROJECT : MIXED-USE PARKING BUILDING

SCALE : N.T.S

DRAWN BY : MJS

CHECKED BY :

DATE : 01 NOV 2022

REMARKS :

DRAWING : LOCATION MAP

REVISION:

DWG NO.:

2/2



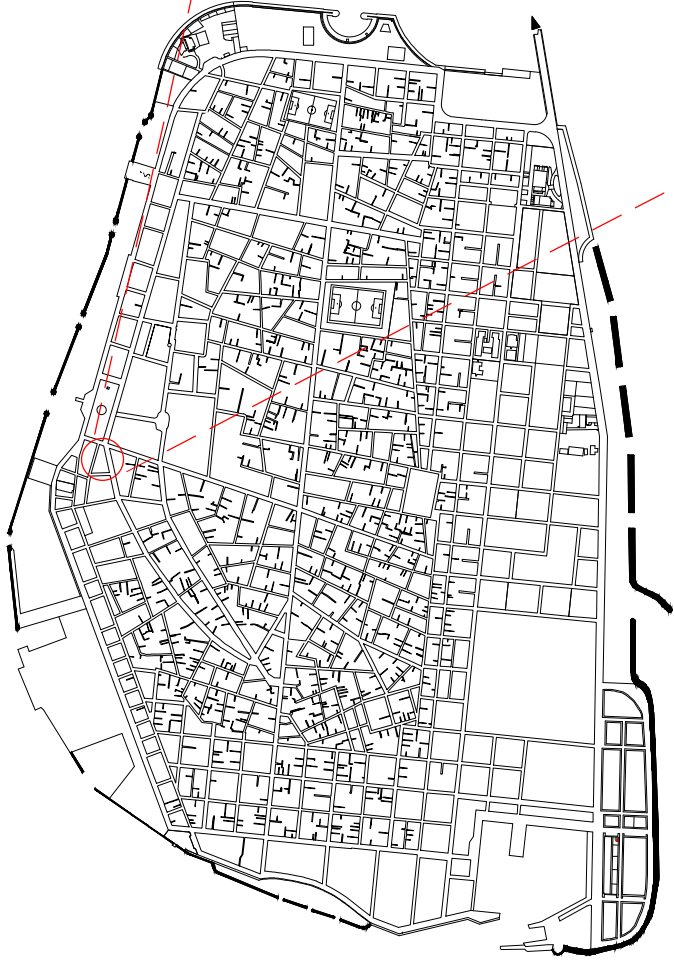

## LOCATION MAP

PROJECT : MIXED-USE PARKING BUILDING

SCALE : N.T.S

DRAWN BY : MJS

CHECKED BY :

DATE : 01 NOV 2022

DRAWING : LOCATION MAP

REVISION:

DWG NO.:

1/2



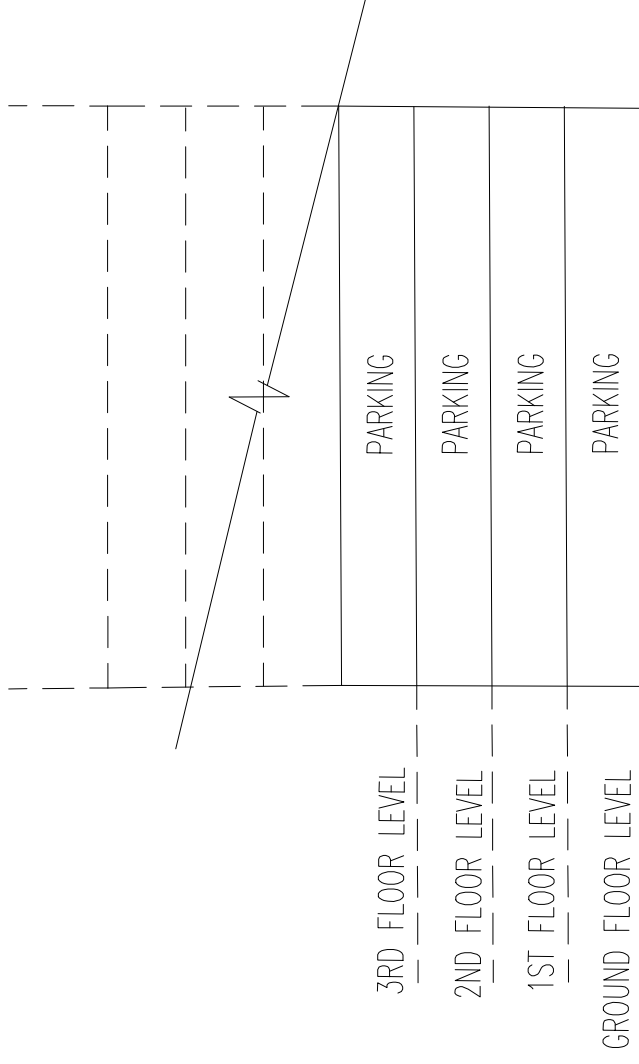
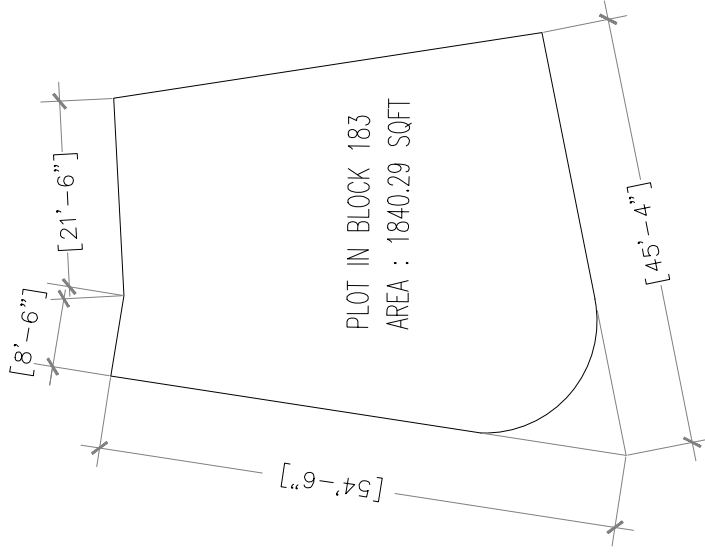

## PLOT MAP

## CONCEPTUAL ELEVATION

PROJECT : MIXED-USE PARKING BUILDING

SCALE : N.T.S

DRAWN BY : MJS

CHECKED BY :

DATE : 01 NOV 2022

REMARKS :

DRAWING : LOCATION MAP

REVISION:

DWG NO.:

2/2



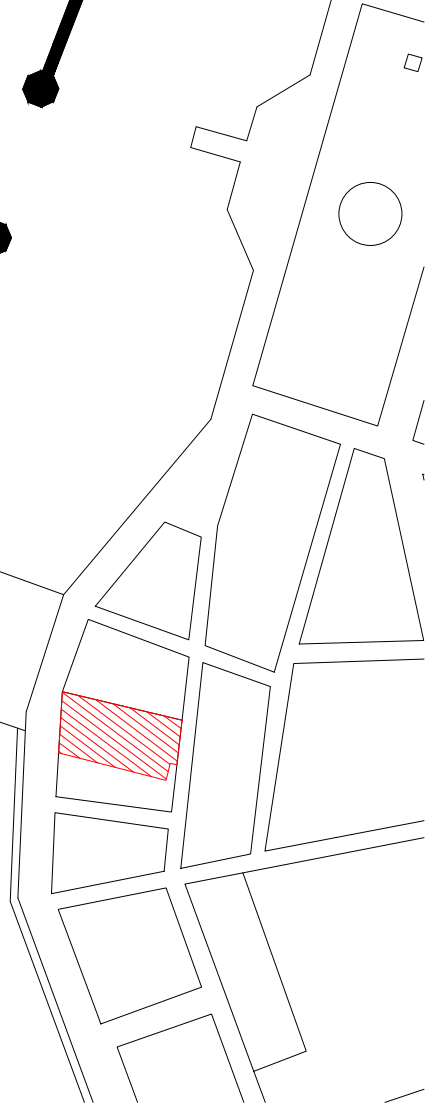
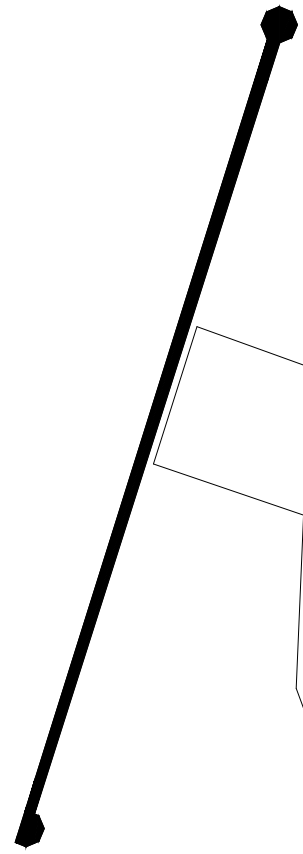
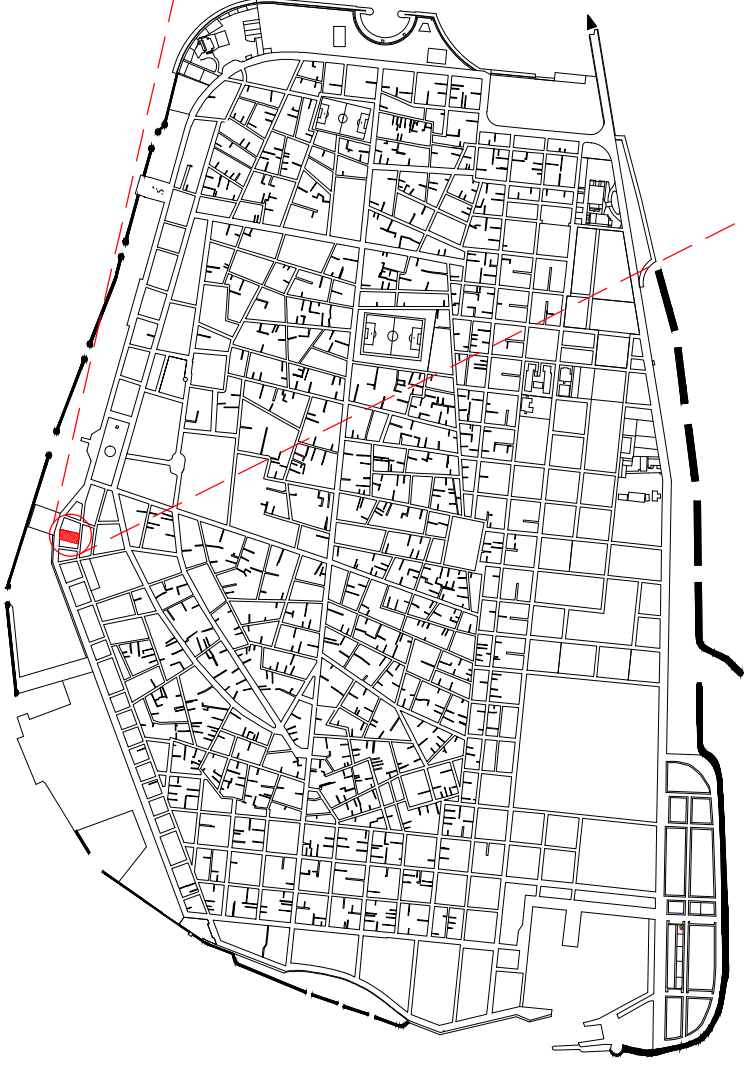

# LOCATION MAP

<b>PROJECT : MIXED-USE PARKING BUILDING</b>		DRAWING : LOCATION MAP	REVISION:	DWG NO.:
SCALE : N.T.S	DRAWN BY : MJS	DATE : 01 NOV 2022	REMARKS :	<b>1/2</b>
		CHECKED BY :		



ދިވެހިރާއްޖޭގެ ޖުމްހޫރިއްޔާ ގުޅިގެން  
MALS CITY COUNCIL



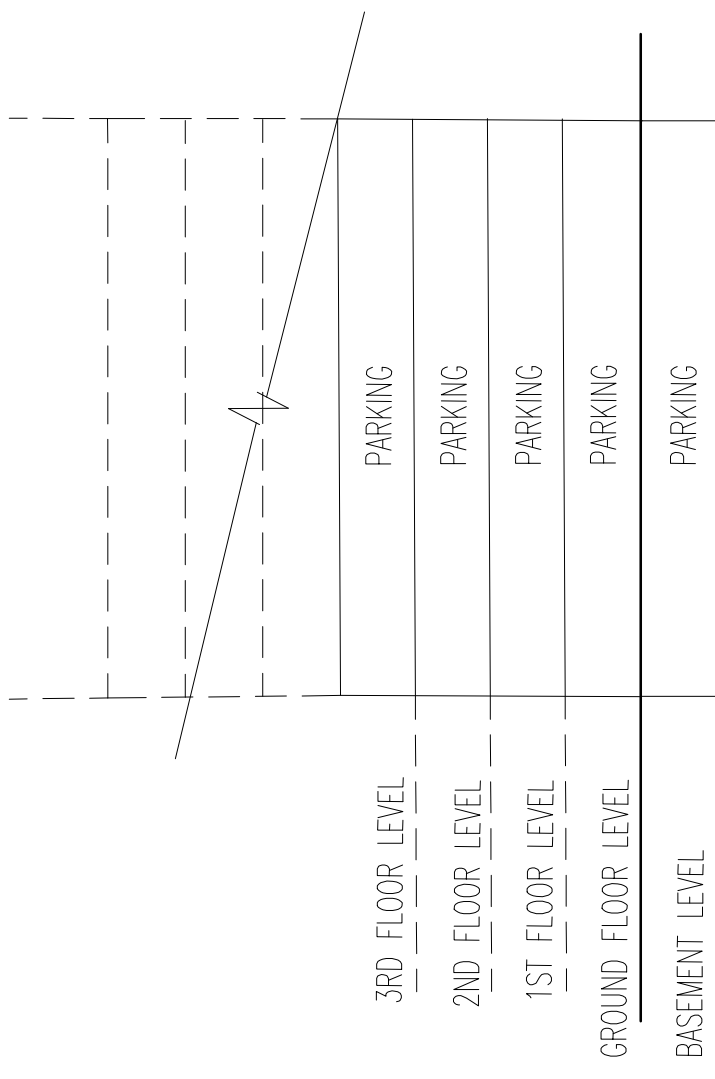
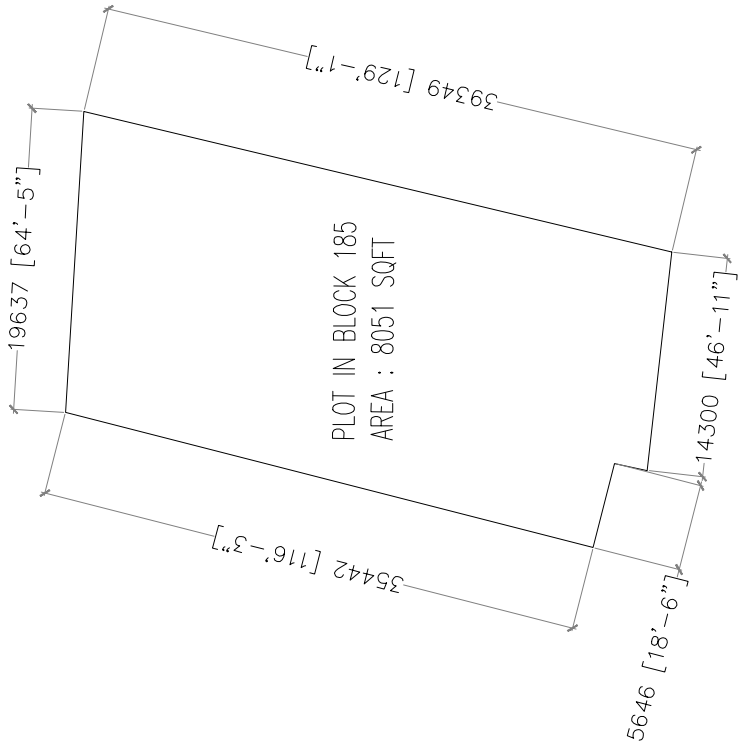

BALANCE ARE INVESTOR'S FLOORS

## PLOT MAP

## CONCEPTUAL ELEVATION

PROJECT : MIXED-USE PARKING BUILDING		DRAWING : LOCATION MAP	REVISION:	DWG NO.:
SCALE : N.T.S	DRAWN BY : MJS	CHECKED BY :	REMARKS :	2/2
DATE : 01 NOV 2022				



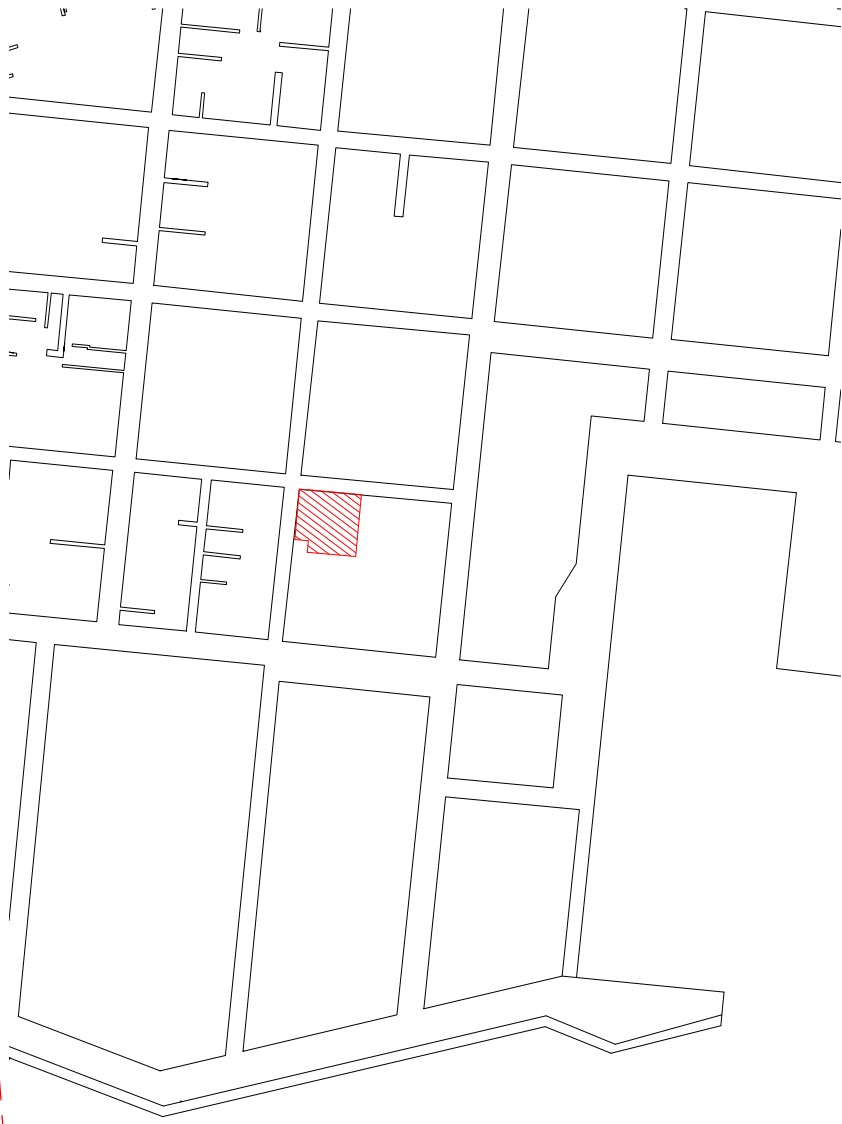
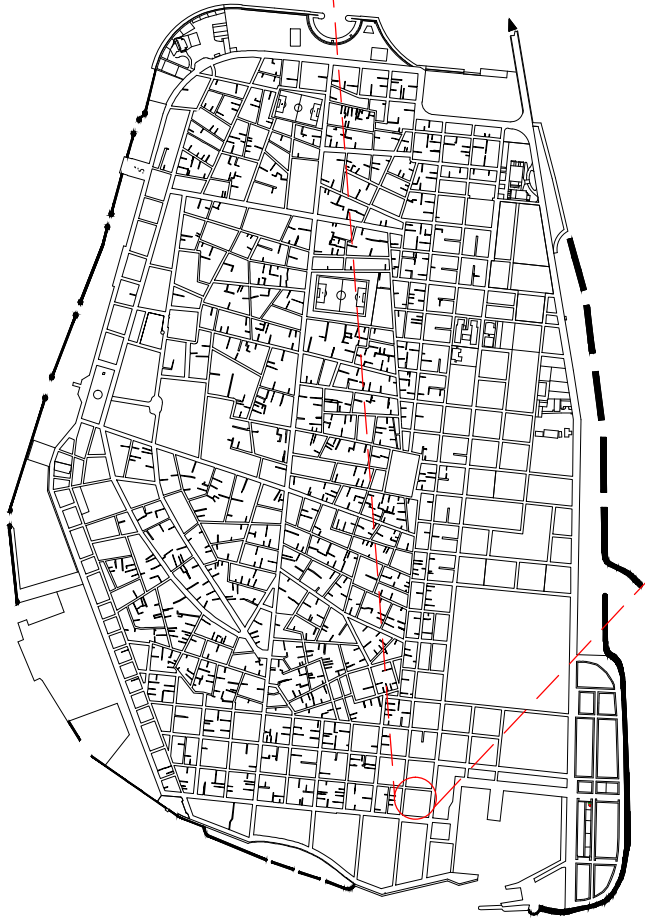

## LOCATION MAP

PROJECT : MIXED-USE PARKING BUILDING

SCALE : N.T.S

DRAWN BY : MJS

CHECKED BY :

DATE : 01 NOV 2022

DRAWING : LOCATION MAP

REVISION:

DWG NO.:

1/2

REMARKS :



2-2-22 8:30 AM  
MAYOR CITY COUNCIL

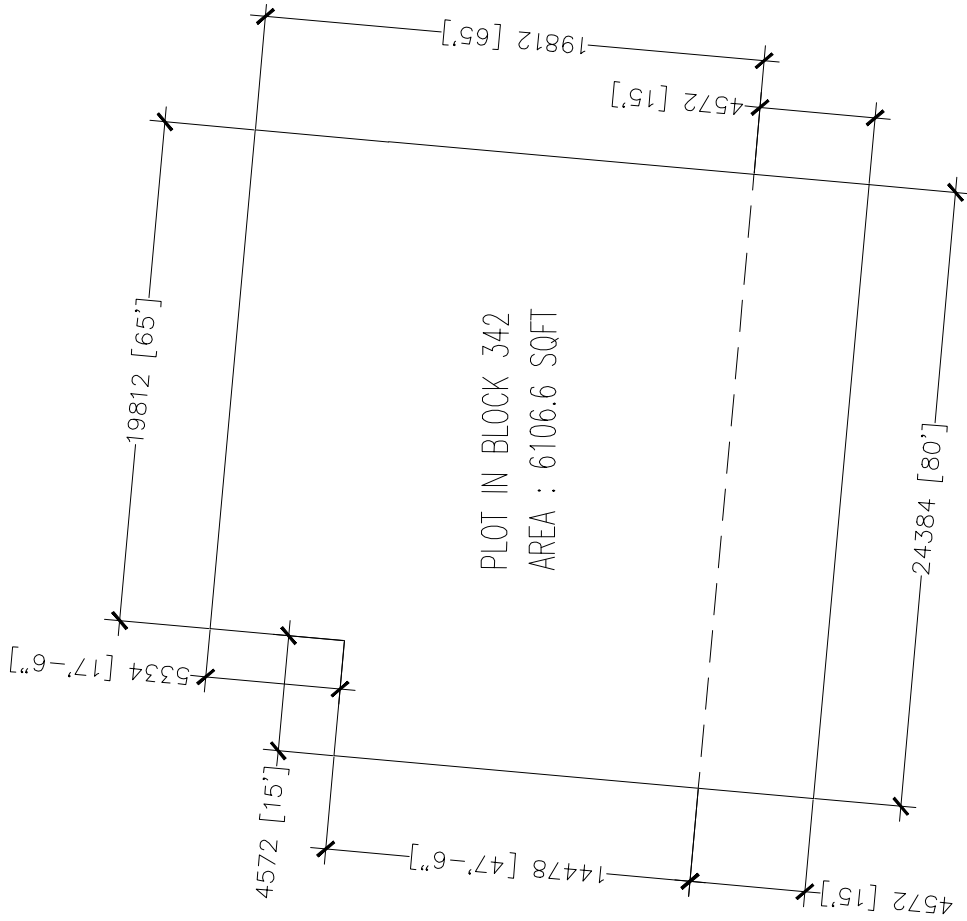

## PLOT MAP

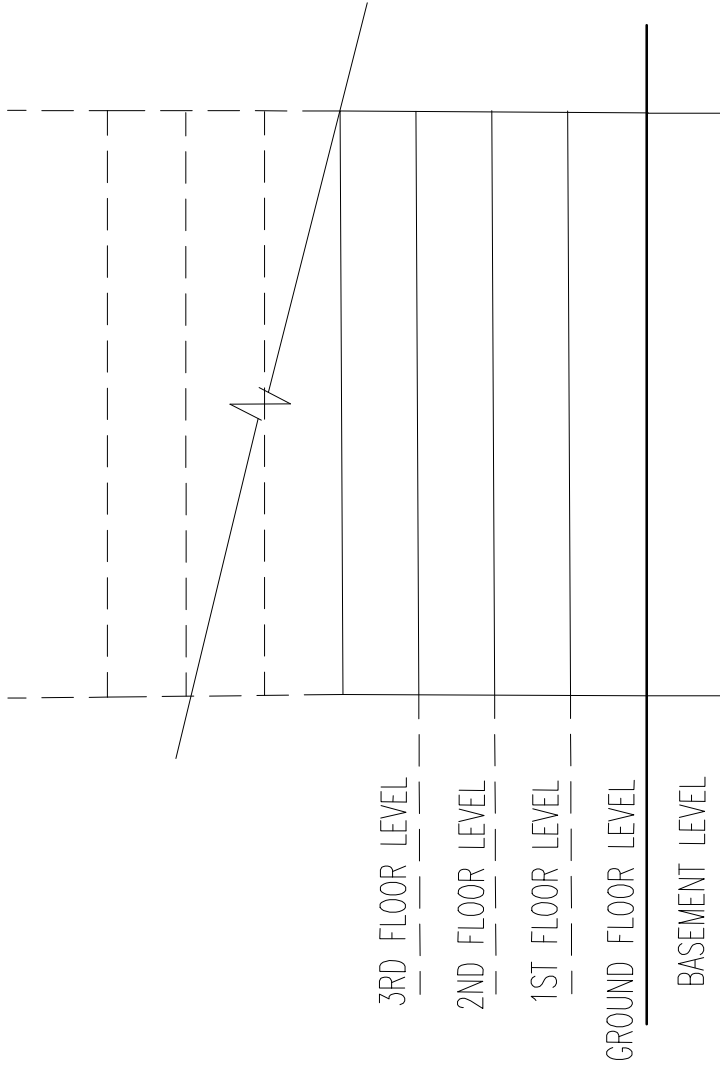

## CONCEPTUAL ELEVATION

PROJECT : MIXED-USE PARKING BUILDING		DRAWING : PLOT MAP CONCEPTUAL ELEVATION		REVISION:	DWG NO:	 Multi City Council
SCALE : N.T.S	DRAWN BY : MIS	CHECKED BY :	DATE : 01 NOV 2022	REMARKS :	2/2	

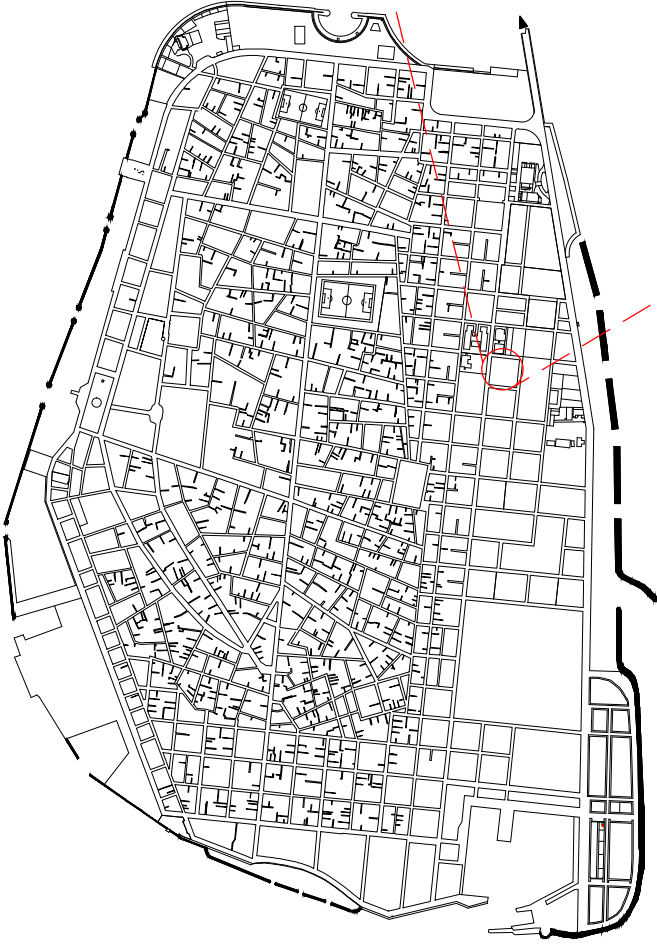

# LOCATION MAP

<b>PROJECT : MIXED-USE PARKING BUILDING</b>		DRAWING : LOCATION MAP	REVISION:	DWG NO.:	
SCALE : N.T.S	DRAWN BY : MJS	CHECKED BY :	DATE : 01 NOV 2022	REMARKS :	

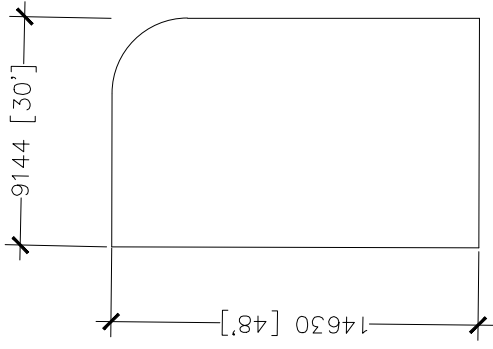

## PLOT MAP

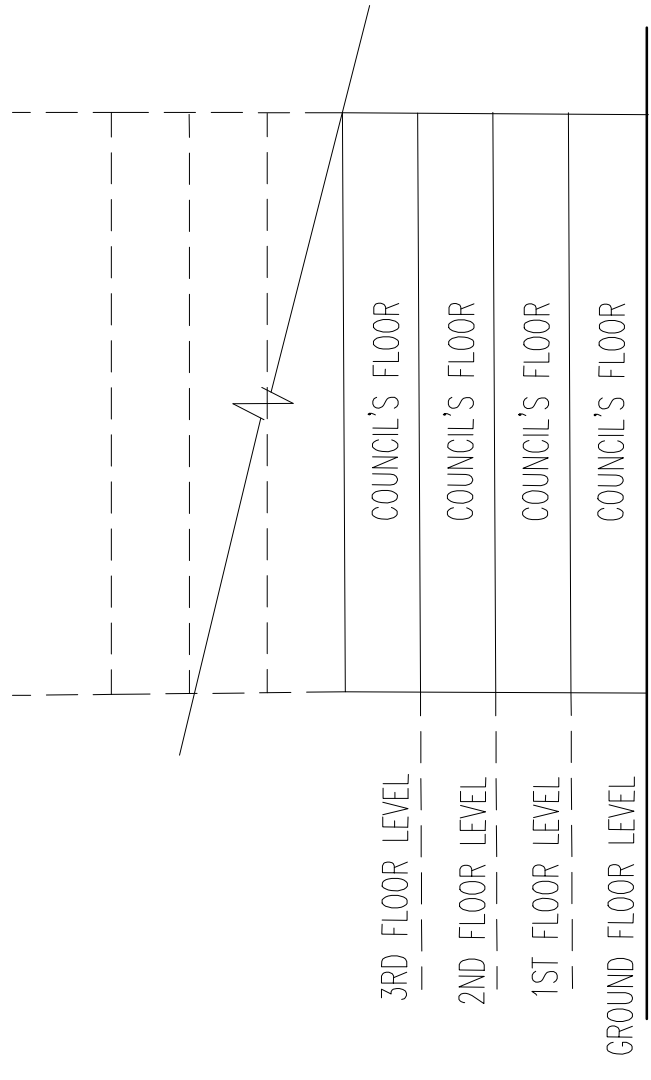

BALANCE ARE INVESTOR'S FLOORS

## CONCEPTUAL ELEVATION

PROJECT : MIXED-USE PARKING BUILDING		DRAWING : PLOT MAP CONCEPTUAL ELEVATION	REVISION:	DWG NO.: <b>2/2</b>	
SCALE : N.T.S	DRAWN BY : MJS	CHECKED BY :	DATE : 01 NOV 2022	REMARKS :	

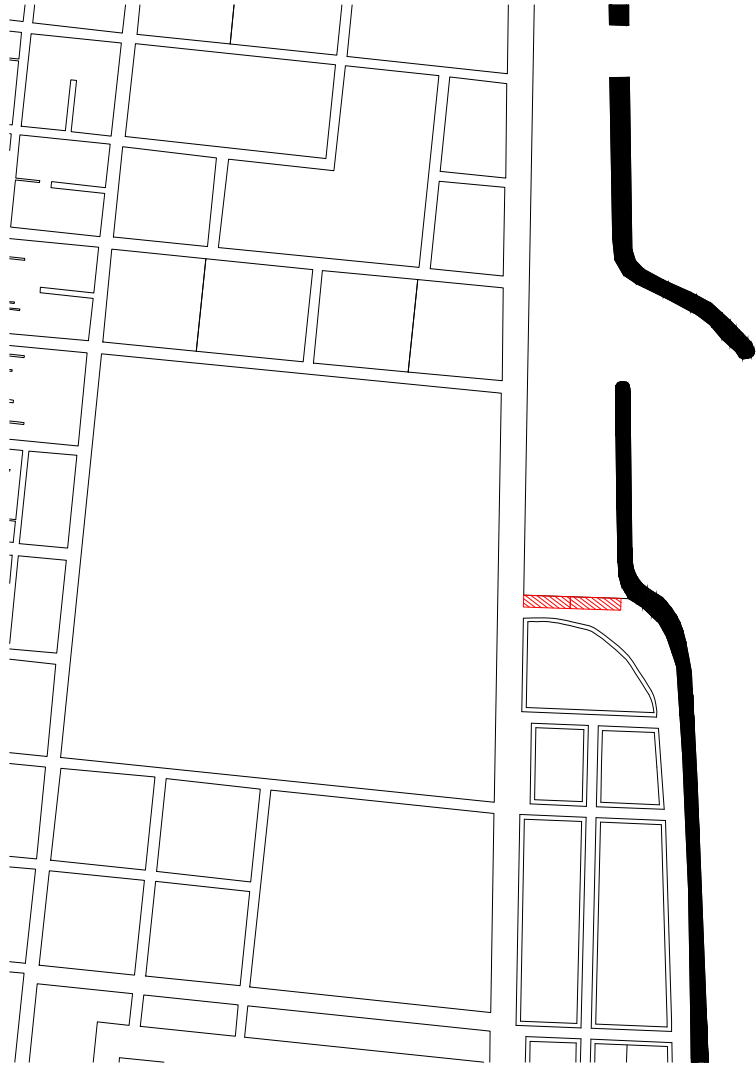
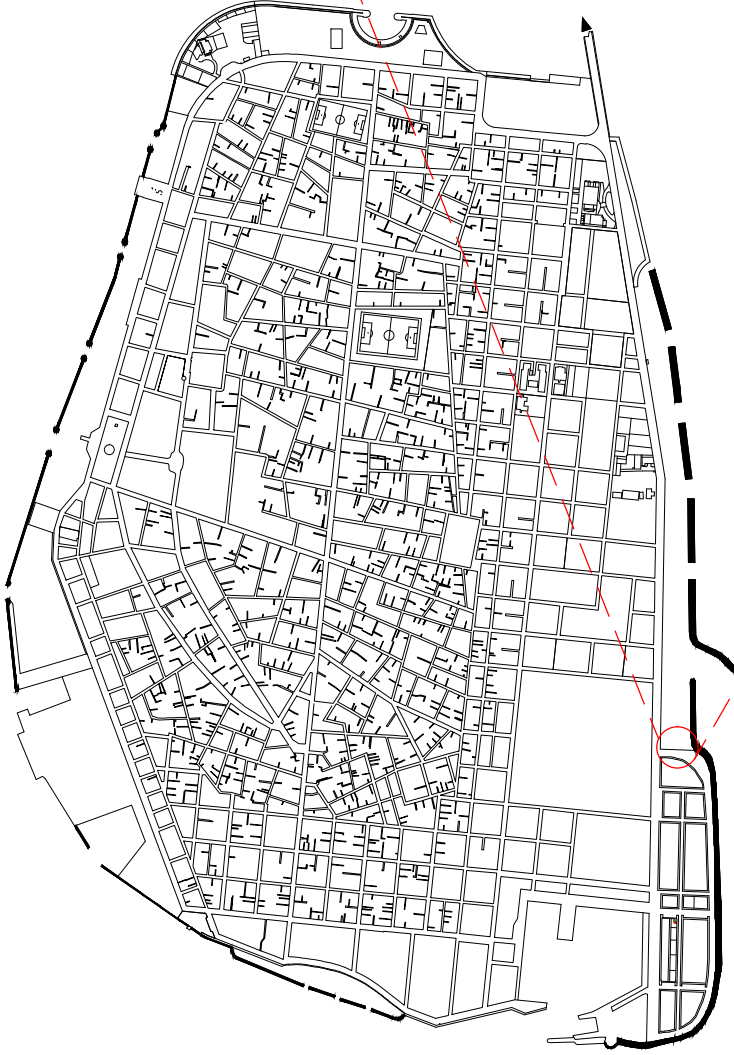

# LOCATION MAP

PROJECT : MIXED-USE PARKING BUILDING

SCALE : N.T.S

DRAWN BY : MJS

CHECKED BY :

DATE : 01 NOV 2022

REMARKS :

DRAWING : LOCATION MAP

REVISION:

DWG NO.:

1/2



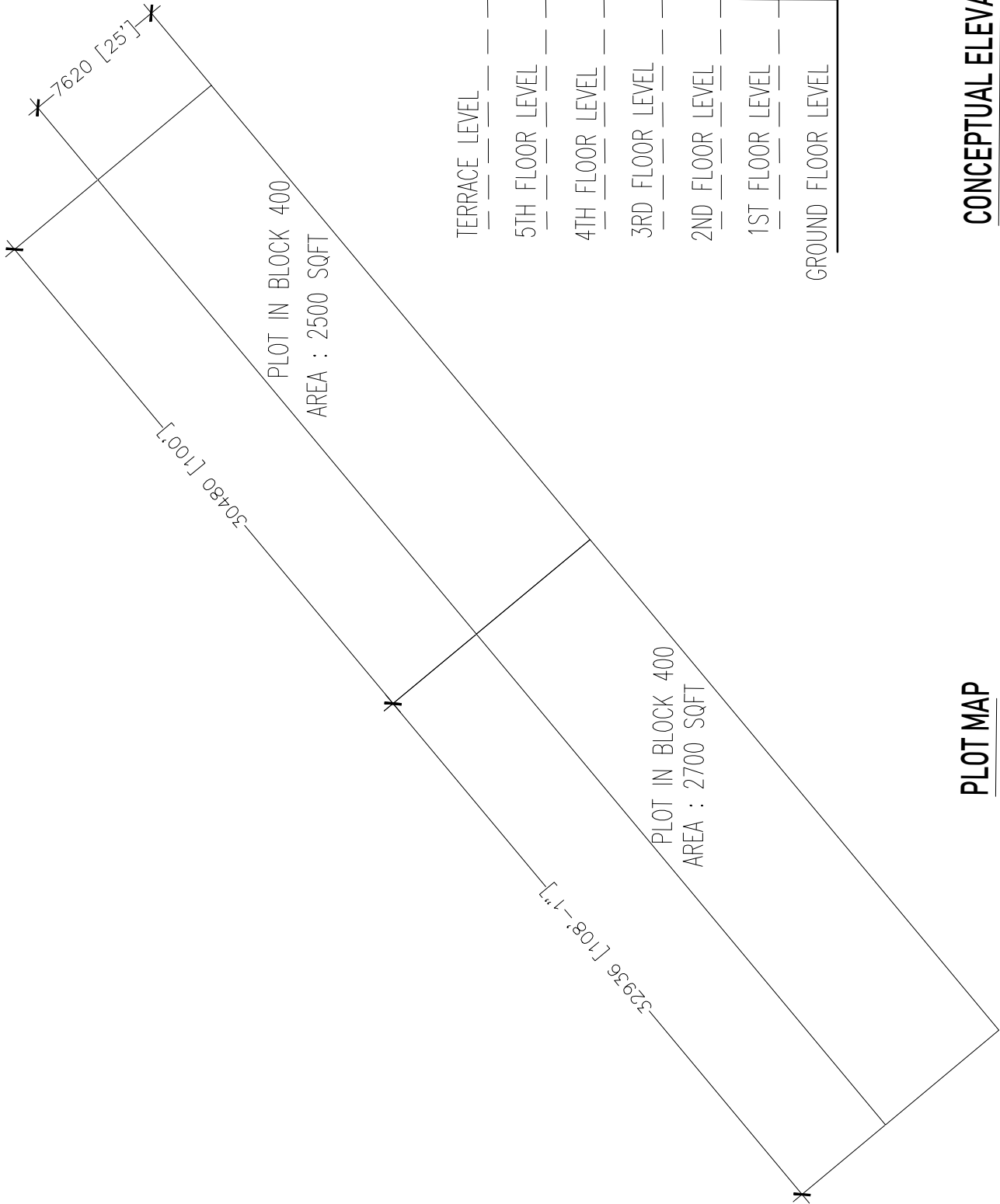

PLOT IN BLOCK 400  
AREA : 2500 SQFT

PLOT IN BLOCK 400  
AREA : 2700 SQFT

TERRACE LEVEL	
5TH FLOOR LEVEL	
4TH FLOOR LEVEL	
3RD FLOOR LEVEL	
2ND FLOOR LEVEL	
1ST FLOOR LEVEL	
GROUND FLOOR LEVEL	GROUND FLOOR LEVEL

### PLOT MAP

### CONCEPTUAL ELEVATION

<b>PROJECT : MIXED-USE PARKING BUILDING</b>		<b>DRAWING : PLOT MAP</b>		<b>DWG NO.:</b>	
SCALE : N.T.S		CONCEPTUAL ELEVATION		2/2	
DRAWN BY : MJS		REVISION:		REVISION:	
CHECKED BY :		REMARKS :		REMARKS :	
DATE : 01 NOV 2022					



Multi City Council

## Form 1 – Registration form for Proposal Submission

---



# REGISTRATION FOR PROPOSAL SUBMISSION

## 1. PROPONENT / BUSINESS NAME

## 2. BUSINESS REGISTRATION NUMBER

## 3. REGISTERED BUSINESS ADDRESS

## 4. CONTACT PERSON

## 5. CONTACT NUMBER

## 6. CONTACT EMAIL

## 7. RFP REREFERENCE NUMBER

## 8. PROJECT NAME

## PROPONENTS DECLARATION

We, the Proponent/Business as given above wish to register our interest to take part in the submission for the RFP for the above given project and the contact point and contact details as given above shall be the primary contact up to the RFP Submission.

## SIGNATURE & STAMP

Date: .....

## Form 2 – Proposal Cover Page Format

---

# PROPOSAL COVER PAGE

It is the responsibility of the Proponent to ensure that the documents listed below are enclosed as the first page of the Proposal document subsequent to which the Proponent may enclose the proposal.

PROPONENT AND PROJECT DETAILS		
Proponent / Business Name:		
RFP Reference Number:		
Project Name:		
Plot No. (if applicable):		
DOCUMENTS CHECKLIST		
Checked by:		
Proponent	Lessor	
		Proposal Cover Page
		Proposal Submission Form
		Bid Security Draft with signed declaration
		Signed Partnership Term sheet if Proponents wish to form a partnership
		Business Registration Copy
		Company Profile
		Project References
		MOA of the Proponent
		AOA of the Proponents
		Comfort Letters from financial institutions if project is to be undertaken from Borrowings
		Board Resolution from Directors if project is to be implemented from Proponents own funds
		Draft Concept design
		Audited Financial Statements for past 3 years or Management Accounts for the most recent year
		Signed Due Diligence Declaration
		Power of Attorney authorizing Proponents representative to sign and submit proposal
		Any revisions to the registered email or authorized contact person who will represent the Proponent

## PROPONENTS DECLARATION

We confirm that we have enclosed the above list of documents along with the proposal and understated that the proposal may be disqualified if the documents are not in accordance with the RFP Proposal Requirements.

Name: .....

Designation: .....

.....

**SIGNATURE & STAMP**

Date: .....

## Form 3 – Proposal Summary Form

---

# PROPOSAL SUMMARY FORM

We, the undersigned, declare that:

1. We have examined and have no reservations to the Request for Proposal (RFP) documents including all addenda issued in accordance with Instruction to Proponents (ITP) 6.
2. We meet the eligibility requirements and have no conflict of interest in accordance with ITP 3.
3. We have no outstanding payment due to the Lessor.
4. We have no non-performance of a contract and non-compliance with court verdicts.
5. Our proposal shall be valid for the period as specified in ITP 13. from the date of proposal submission in accordance with RFP document and it shall remain binding upon us and may be accepted at any time before the expiration of that period.
6. We understand that this proposal, together with your written acceptance thereof included in your notification of award, shall constitute a binding contract between us, until a formal contract is prepared and executed; and
7. We understand that Lessor is not bound to accept the highest evaluated proposal or any proposal that may receive.
8. Accordingly, we shall furnish all the required detailed documents as may be pertinent to the evaluation process, and the summary of our proposal and terms are as proposed below:

1. PROPONENT AND PROJECT DETAILS		
Proponent / Business Name:		
Proponent Registered Address:		
Proponent Registration Number:		
RFP Reference Number:		
Project Name:		
Plot No. (if applicable):		
2. PROPOSED RENT		
We undertake to pay the rent as per Section II, 1. of the RFP, and our offer of rent for the first 05 (five) years, per square feet, per month, for the Project location, are as follows:		
Year	Amount in numbers (MVR) / month / sq.ft	Amount in Words in Maldivian Rufiyaa per month per square feet
Year 1	Amount in numbers	Amount in words
Year 2	Amount in numbers	Amount in words
Year 3	Amount in numbers	Amount in words
Year 4	Amount in numbers	Amount in words
Year 5	Amount in numbers	Amount in words
3. DEVELOPMENT COST		
Estimated total project cost for parking floors (excluding Proponents commercial floors) in Maldivian Rufiyaa is:	Amount in numbers:	Amount in numbers
	Amount in Words:	Amount in words
4. LEASE PERIOD		
We propose to lease the development to us for a total lease period (excluding any development and/or grace period) for a total duration in number of years total of:		Total number of years

**5. DESIGN CONCEPT**

Our design concept for the proposed development is summarized below and the final detailed designs, unless otherwise agreed with the Lessor, shall conform to the requirements as described below. I understand that the Lessor may reject the proposed design if it is not in conformity with the requirement of the Lessor.

A brief description of the design concept for the project highlighting any points that the Proponent wishes to take note

**6. PROPOSED TOTAL GFA AND FLOORS TO BE HANDED OVER TO LESSOR**

We propose our development to consist of a total GFA as follows:	Total approximate GFA in sq.ft. of total project
We propose to hand over the following floors to the Lessor on completion of the Project:	Floors Numbers (i.e., basement, ground, first, ... etc)
Estimated GFA of the floors to be handed over to Lessor as proposed above is (total sq.ft.):	Total GFA in sq.ft. of floors for Lessor

**7. CAPACITY OF THE PROPONENT**

A brief description of the Proponents capacity to undertake the project highlighting any financial, technical and background details of the Proponent that maybe pertinent to the verification of the Proponents capacity to undertake the project

**8. ADDITIONAL INFORMATION**

Any additional information that that the Proponent wishes to highlight in support of the Proponents proposal

**PROPONENTS DECLARATION**

We confirm that we have enclosed the above list of documents along with the proposal and understated that the proposal may be disqualified if the documents are not in accordance with the RFP Proposal Requirements.

Name: .....

Designation: .....

**SIGNATURE & STAMP**

Date: .....

## **Form 4 – Power of Attorney to Sign and Submit Proposal**

---

The Proponent may utilize their own format of the Board Resolution for assignment of the Power of Attorney, but the following information and points should be included in the Board Resolution submitted with the Proposal

- Project RFP Number
- Project Name
- Plot Number (if applicable)
- Details of the receiver of Power of Attorney (Name and Identification details)
- Contact details of the Power of Attorney with email and contact number
- Rights of the Power of Attorney (signatory only, signatory and representation ... etc)

The Board Resolution assigning the Power of Attorney should be signed by the quorum of the Directors of the Company and should comply with all other requirements of the Articles and legal requirements for compliance as a valid Power of Attorney.

## Form 5 – Board Resolution Sample

---

The Proponent may utilize their own format of the Board Resolution for confirmation of intention to participate in the RFP, but the following information and points should be included in the Board Resolution submitted with the Proposal

- Proponent Details covering Proponent registered name, registered address and registration number
- Project RFP Number
- Project Name
- Plot Number (if applicable)
- Confirmation of intention to participate in the RFP and to be bound by the requirements of the RFP and acceptance of the RFP outcome

The Board Resolution should be signed by the quorum of the Directors of the Company and should comply with all other requirements of the Articles and legal requirements for compliance as a valid Board Resolution of the Company.



## Form 6 – Bid Security Sample with Declaration

---

## Form 6 – Bid Security Sample with Declaration

---

The Issuing Bank shall fill in this Bank Security Form in accordance with the instructions indicated.

..... [Bank's Name, and Address of Issuing Branch or Office]

**Beneficiary:** Male' City Council, 3rd Floor, MWSC Customer Services Building, Ameenee Magu, Malé, Republic of Maldives,

**Date:** .....

**Bid Security No:** .....

We have been informed that ..... [name of the proponent] (hereinafter called "the Proponent") has submitted their proposal dated ..... [date of proposal submission] for the execution of ..... [name of project] (hereinafter called "the Project") under Request for Proposal No. .... [request for proposal reference no.] hereinafter called "the RFP".

Furthermore, we understand that, according to your conditions, the Proposals must be supported by a Bid Security.

At the request of the Proponent, we ..... [name of Bank] hereby irrevocably undertake to pay you any sum or sums not exceeding in total an amount of ..... [amount in figures] ..... [amount in words] upon receipt by us of your first demand in writing accompanied by a written statement stating that the Proponent is in breach of its obligation(s) under the RFP conditions, because the Proponent:

- (a) has withdrawn its Proposal during the period of Proposal validity specified by the Proponent in the Letter of Proposal; or
- (b) having been notified of the acceptance of its Proposals by the Lessor during the period of Proposal validity,
  - (i) fails or refuses to pay lease deposit, or
  - (ii) fails to execute the terms and conditions of the Conditional Award of the Lessor.

This guarantee will expire: (a) if the Proponent is the successful Proponent, upon our receipt of copies of the agreement signed by the Proponent and the lease deposit furnished to you upon the instruction; and (b) if the Proponent is not the successful Proponent, upon the earlier of (i) our receipt of a copy of your notification to the Proponent of not being the successful Proponent; or (ii) **180 (One Hundred and Eighty)** calendar days from [date of submission] of this Bid Security in respect of the Proposal submitted for the RFP.

Consequently, any demand for payment under this guarantee must be received by us at the office on or before that date.

This guarantee is subject to the Uniform Rules for Demand Guarantees, ICC Publication No. 458

**[seal and signature of the bank / valid institution]**

## PROONENTS DECLARATION

We, the Proponent, confirm that we shall promptly furnish the Bid Security in the format as given above on receipt of the call for the Bid Security, and shall furnish the said Bid security from any one of the following entities, who are compliant with the eligibility of the RFP requirements for issuance of Bid Securities, and will submit the Bid Security within the time frame as required by the Lessor.

We further understand and accept that on our failure to furnish the said Bid Security as requested, the Lessor reserves the right to reject and disqualify our Proposal.

Proposed Banks: .....

Name: .....

Designation: .....

**SIGNATURE & STAMP**

**Date:** .....

## Form 7 – Summary of Business Plan

---

# SUMMARY OF BUSINESS PLAN

We, the undersigned, declare that:

1. We have examined the Lessors requirements for the Project as stipulated in Section III of the RFP and have undertaken our detailed assessments for the Project based on the requirements.
2. Should our proposal be accepted, we shall be undertaking the Project within the overall project management and implementation framework as summarized below.
3. The summaries as presented below shall form the basis for our detailed business plan for the Projects which shall be made available to the Lessor when called for.
4. Accordingly, we furnish a summary of our proposed business plan for the project for your review.

1. PROPONENT AND PROJECT DETAILS	
Proponent / Business Name:	
Proponent Registration Number:	
RFP Reference Number:	
Project Name:	
Plot No. (if applicable):	
2. OUTLINE OF THE PROJECT	
<p>A summary of the Proponents plan for the project covering the overall scope, design details and overall objectives for the project as planned for by the Proponent</p>	
3. MANAGEMENT AND HR PLAN	
<p>A summary of the Proponents overall plan for the management of the created asset covering the staffing and management requirements for the project.</p>	

#### 4. MARKETING PLAN

A summary of the Proponents plans to market and generate revenue from the asset, covering components such as the pricing and marketing strategy for the components developed under the asset. The summary should cover relevant details such as the target segments, promotional strategies, and overall products and services to be provided through the development of the asset.

#### 5. OPERATIONAL PLAN

A summary of the Proponents overall project development and project implementation covering key components of the planned civil works. Summaries of the project management and civil works team, including construction approach may be detailed here. A summary project schedule and an indicative BOQ should be submitted along with any other summary details.

#### 6. FINANCIAL PLAN

A summary of the Proponents financial plan for the implementation and operation of the asset. The summary should provide the project funding/financing strategy, and highlights of the 5-year financial forecasts for the project along with any other financial details the Proponent may wish to submit at this stage.

### **PROPOSERS DECLARATION**

We confirm that the above details are a summary of the contents of the business plan for the project to be developed under the RFP and will submit the detailed business plan in line with the above summary when requested for by the Lessor.

Name: .....

Designation: .....

.....

**SIGNATURE & STAMP**

Date: .....

## **Form 8 – Due Diligence Declaration**

---

The Proponent is to use whichever of the forms is applicable to the Proponent based on the applicability to the Proponent.

The Lessor may seek further clarification on the details given in the Declaration and the Lessor reserves the right to disqualify any proposal if the Lessor finds any false details presented in the Declaration.

# DUE DILIGENCE DECLARATION

## Format 1 - Declaration of Existence of Pending, Threatened or Ongoing Litigations

### Re: Declaration of Pending or Threatened Litigations

The following is the list of all ongoing public and/or private litigation, suit, proceeding investigation, adjudication, arbitration and governmental proceedings wherein we, the Proponent and/or our Directors is or likely to be a party, or which is threatened against any of us, or for which there are ongoing responsibilities of any of us.

No	Claimant	Defendant	Brief Description of Claim

I hereby declare that, except for the above, there is no action, suit, proceeding, investigation, adjudication, arbitration, or litigation pending or, to our knowledge, threatened, which either in any one instance or in the aggregate, if determined adversely to us would materially and adversely affect the execution or progression of the Project, or our ability to perform the obligations under the Agreement for the execution of the Project.

### PROPONENTS DECLARATION

I hereby declare under penalty of perjury that the foregoing is true and correct.

Name: .....

Designation: .....

.....

**SIGNATURE & STAMP**

Date: .....



**Format 2 - Declaration of No Pending Litigation**

**Re: Declaration of No Pending Litigation**

I hereby declare that there is no action, suit, proceeding, investigation or litigation pending or, to our knowledge, threatened, which either in any one instance or in the aggregate, if determined adversely to us would materially and adversely affect the execution or progression of the Project, or our ability to perform our obligations under the Agreement for the execution of the Project.

**PROponents DECLARATION**

---

I hereby declare under penalty of perjury that the foregoing is true and correct.

Name: .....

Designation: .....

.....

**SIGNATURE & STAMP**

**Date:** .....