

4X300W LED LIGHT

100MM DIA 3MM THICK, 3M LONG 3
NOS GI PIPE WELDED AT ENDS

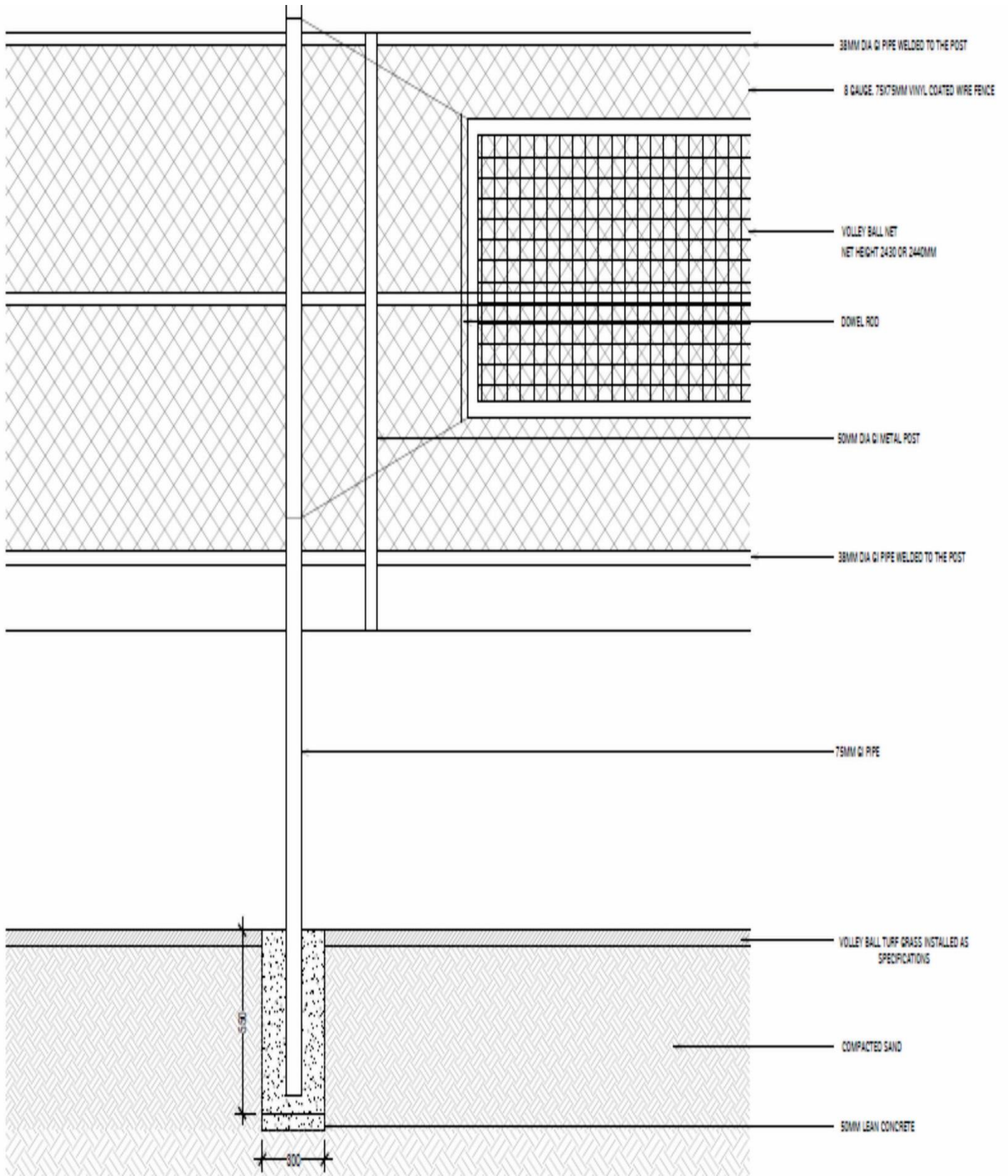

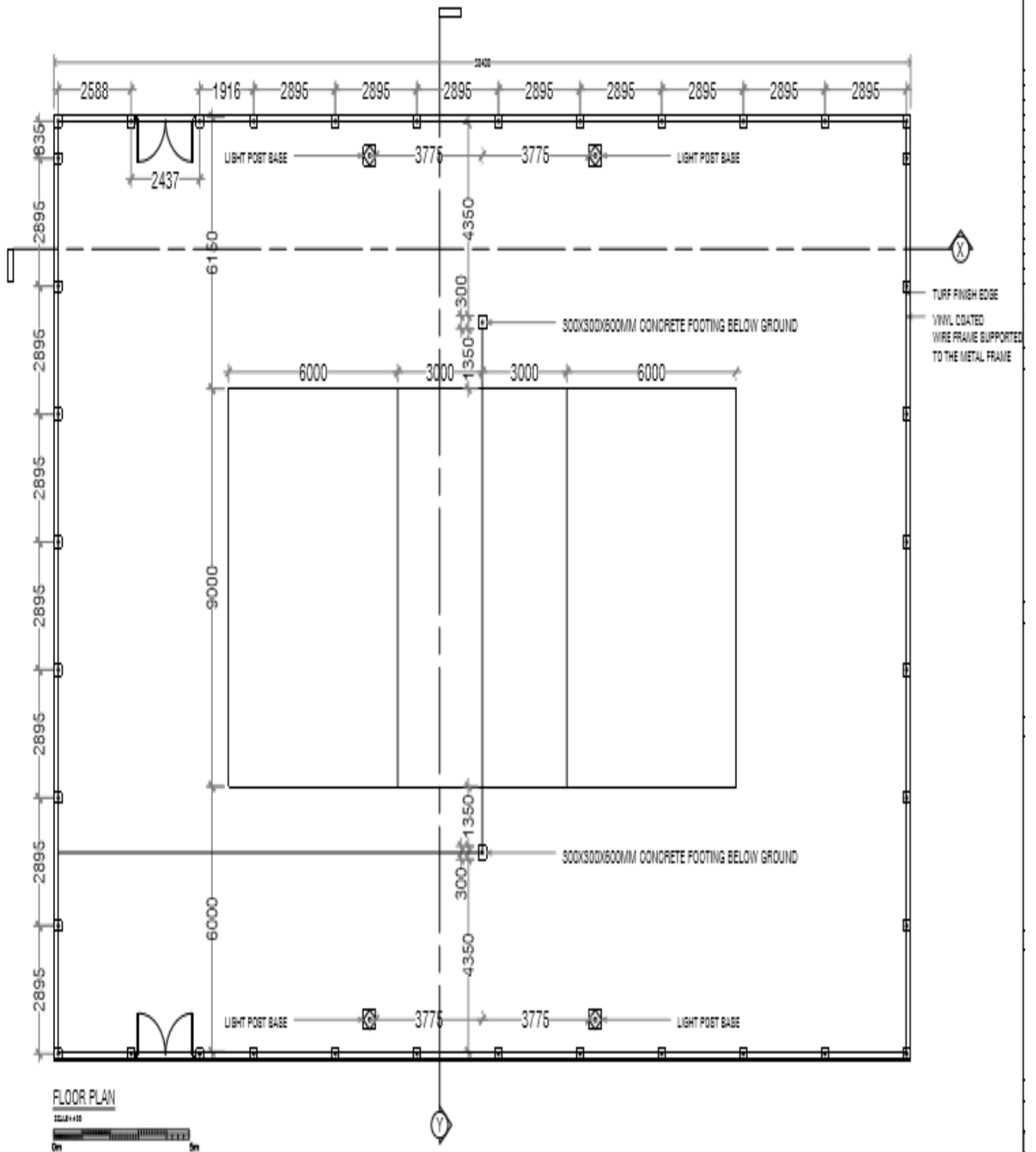

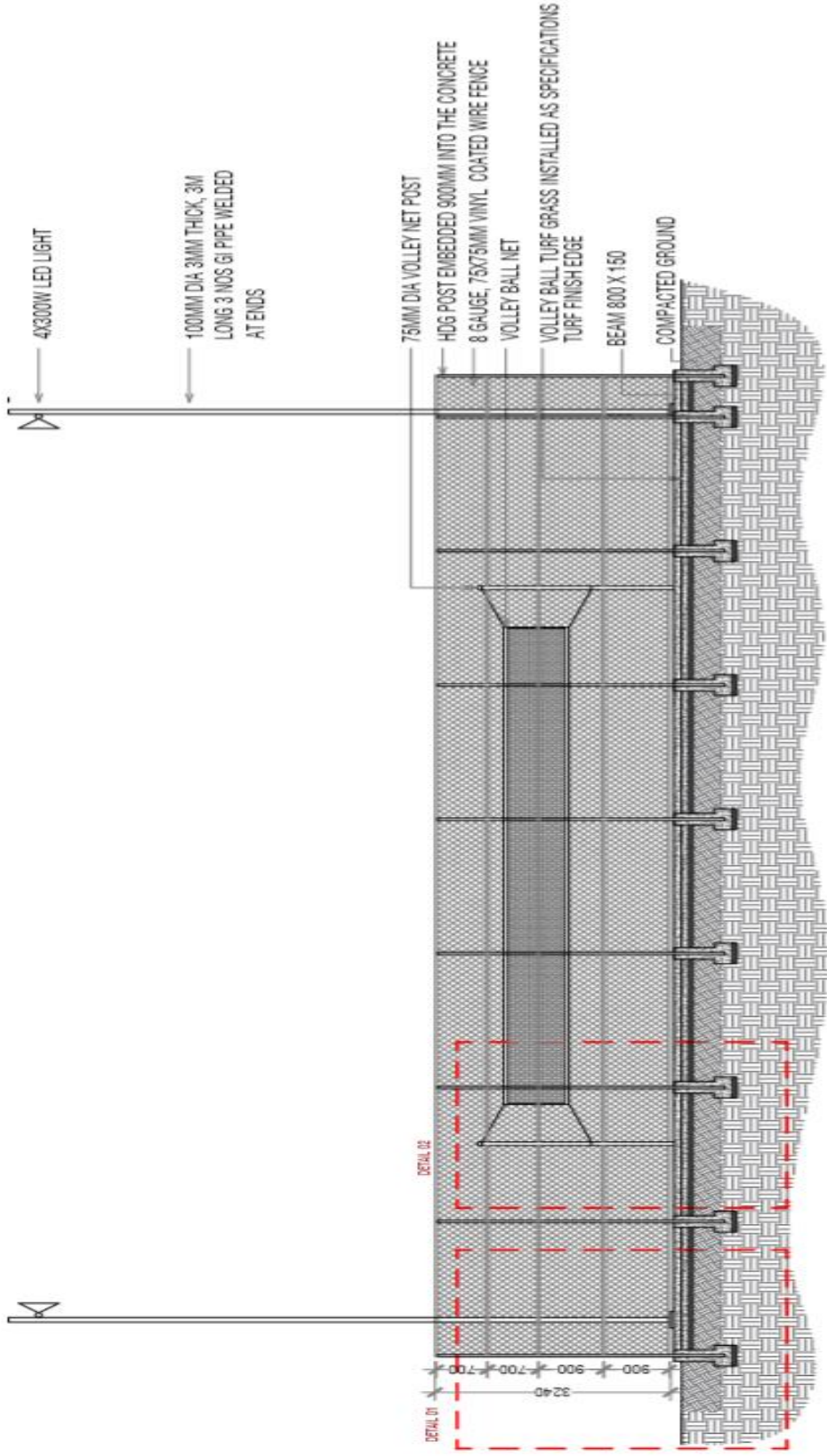

SECTION X-X

SCALE 1:100

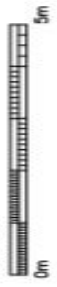

COLUMN FOOTING DETAIL

SIZE	REINFORCEMENT
450 x 450 x 250 MM BASE	T10 @ 150 C/C BOTHWAYS
250 x 250 x 550 MM TOP	T10 @ 150 C/C BOTHWAYS

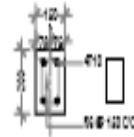

FOUNDATION BEAM



COLUMN

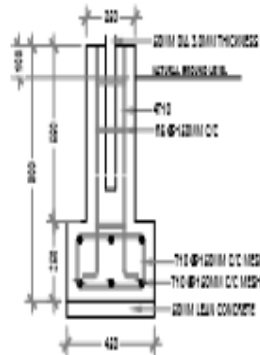

COLUMN FOOTING

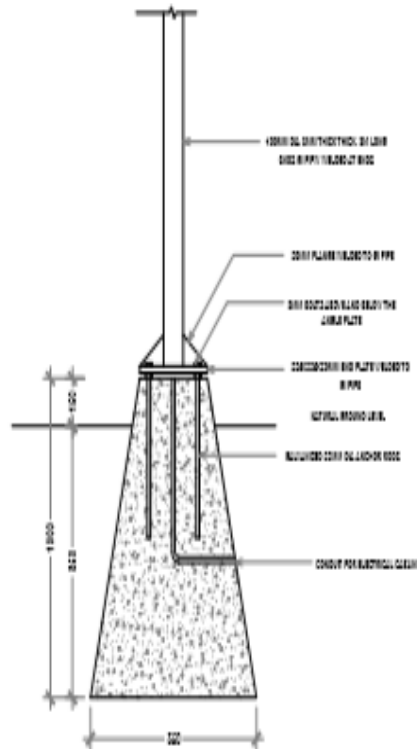

LIGHT POST
FIXING DETAIL

LIGHT POST
REINFORCEMENT DETAIL

2024-1-21

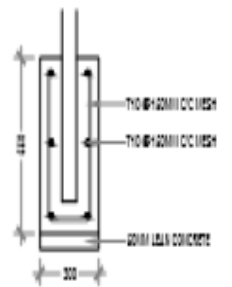

VOLLEY NET POST FOOTING

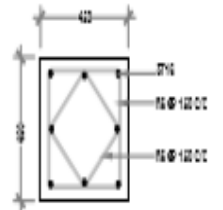

LIGHT POST FOOTING DETAIL

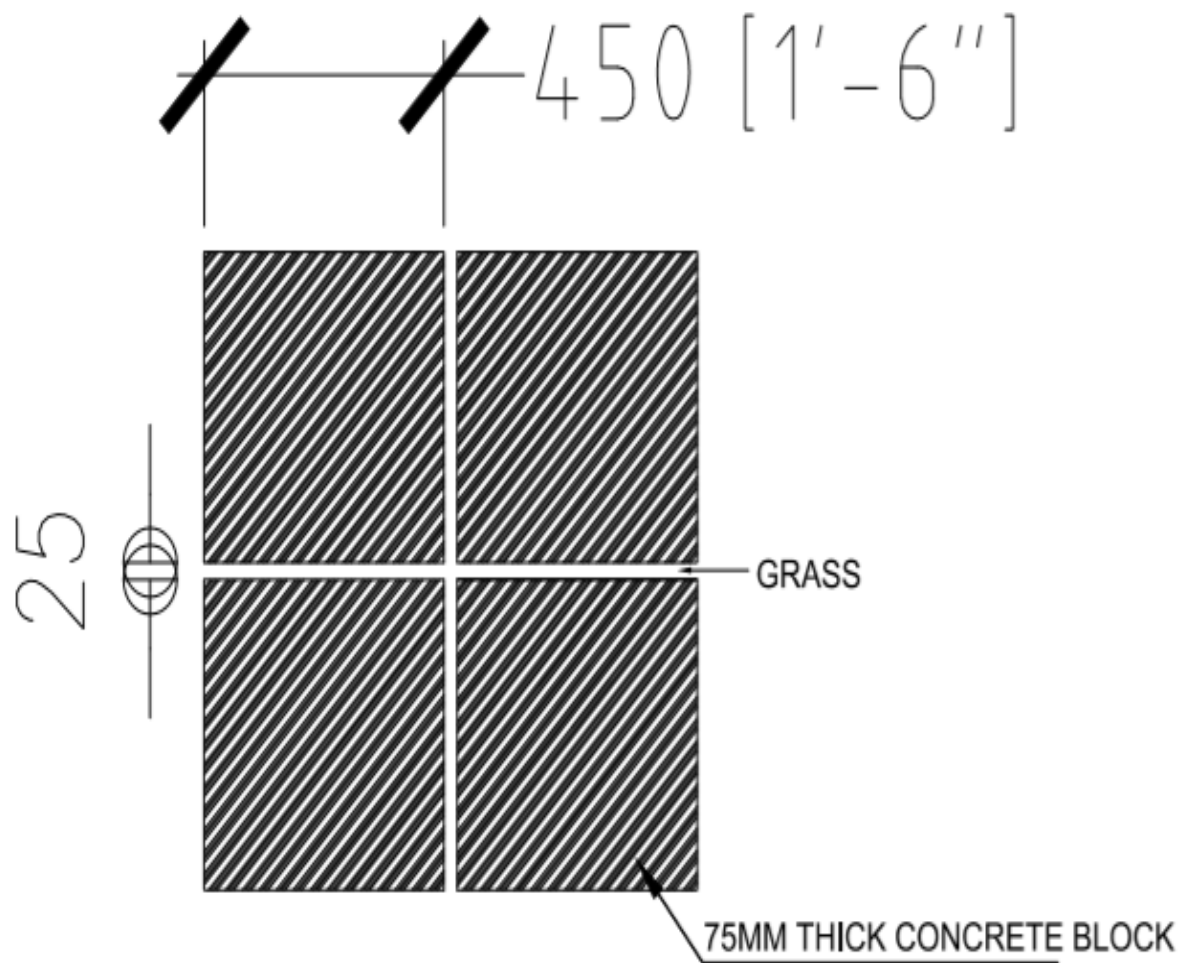

DETAIL-PAVING BLOCKS

Scale - 1:20

GUT-CVR TECHNICAL DATA SHEET

RCC Settlement Tank Cover

MRDC's engineering quality cement concrete products (MRDC Blocks) are durable, high strength bricks, specially manufactured to cope with exposure to abrasive conditions.

This can be used in the gutter line to cover the gutter line.

Settlement Tank Cover Specification

Form	RCC grating gutter cover
Appearance	Standard gray colour - untreated surface
Size	1000mm x 400mm x 500mm and 80mm thickness
Composition	OPC + River sand + Aggregates
Density	Average 2567.6kg/m ³
Dry Weight	90kg approximately
Strength	Average 19.0N/mm ²
Surface treatment	Untreated
Area coverage	N/A
Presentation	Pellet containing 30 Nos
Pack Weight	2715kg approximately including pellet
Approx Pack Dimension	1.0m x 1.0m x 1.0m height approximately

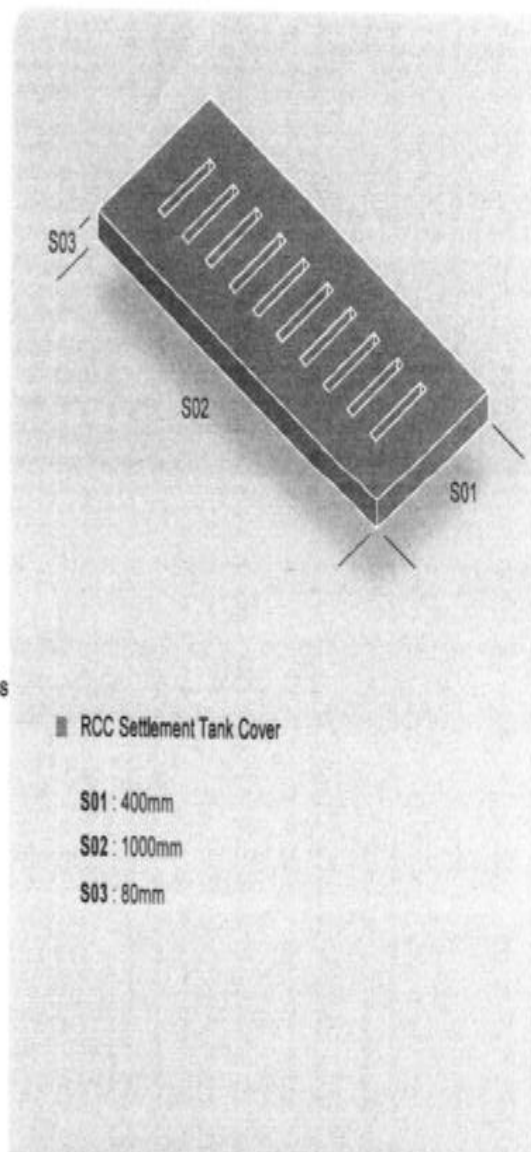

SETT-T TECHNICAL DATA SHEET

Settlement Tank

MRDC's engineering quality cement concrete products (MRDC Blocks) are durable, high strength bricks, specially manufactured to cope with exposure to abrasive conditions.

This can be used to collect water from gutterline.

Settlement Tank Specification

Form	Solid PCC settlement tank
Appearance	Standard gray colour - untreated surface
Size	1000mm x 400mm x 800mm and 60mm thickness
Composition	OPC + coral sand + coral stone
Density	Average 2174.9kg/m ³
Dry Weight	330kg approximately
Strength	Average 13.6N/mm ²
Surface treatment	Untreated
Area coverage	N/A
Presentation	Pellet containing 5 Nos
Pack Weight	1665kg approximately including pellet
Approx Pack Dimension	1.0m x 1.0m x 1.0m height approximately

