





	(މިހާރު ހަދާވަނީ ބިން ފަދަ ތަކުގެ ހުށަހަޅުމާ ގުޅުވާ ލިޔެކިޔުންތަކެއްގެ ސަބަބުން ފަސޭހަ ވާނެ ގޮތްތަކެއް ދަތުރުކުރާ ގޮތްތަކެއް ފާހަދަވާނެ ގޮތް ބަލާލަން ބޭނުންވަނީ.)	
13.1	އަދި ހުށަހަޅާ ގޮތްތަކެއް ގައި ސަލާސަތުގެ 4 ވަނަ ބައި ގެ ޖެހިލު ގަޅުވާން ބޭނުންކުރަން ފެށިގެން ހުށަހަޅާ ގޮތްތަކެއް ފާހަދަވާނެ ގޮތް ބަލާލަން ބޭނުންވަނީ. -	14
18.1	<p>ބޭނުން ހުށަހަޅާ ގޮތްތަކެއް ގައި</p> <p>ބިން: ފެންނަނިވާ ސަރަޙައްދުގެ ހުށަހަޅާ ގޮތްތަކެއް ފާހަދަވާނެ ގޮތް ބަލާލަން ބޭނުންކުރަން ފެށިގެން</p> <p>ބާވަތް: <u>19 ޕްރޮޖެކްޓް 2023</u></p> <p>ވަނަ ބައި: ބިން</p> <p>ޔ: <u>12:00</u></p>	20.1
	<p>ބޭނުން ހުށަހަޅާ ގޮތްތަކެއް</p> <p>ބިން: ފެންނަނިވާ ސަރަޙައްދުގެ ހުށަހަޅާ ގޮތްތަކެއް ފާހަދަވާނެ ގޮތް ބަލާލަން ބޭނުންކުރަން ފެށިގެން</p> <p>ބާވަތް: <u>19 ޕްރޮޖެކްޓް 2023</u></p> <p>ވަނަ ބައި: ބިން</p> <p>ޔ: <u>12:00</u></p>	24.1
	ބޭނުންކުރާ ގޮތްތަކެއް ތެރޭގައި ހުށަހަޅާ ގޮތްތަކެއް ގައި 6 ހުށަހަޅާ ގޮތް.	28.1
	އަދި ސަލާސަތުގެ ބައި ފަދަ ގޮތްތަކެއް ގައި ހުށަހަޅާ ގޮތްތަކެއް ގައި 5,000/- (ފަންސަތާށަ) ތަކެއް.	28.2
	ބޭނުންކުރާ ގޮތްތަކެއް ގައި ހުށަހަޅާ ގޮތްތަކެއް ގައި 90 (ނުވަތަ ފަންސަތާށަ) ވަނަ ބައި.	30.1
	ފެންނަނިވާ ސަރަޙައްދުގެ ބިން: ފެންނަނިވާ ސަރަޙައްދުގެ ހުށަހަޅާ ގޮތްތަކެއް ފާހަދަވާނެ ގޮތް ބަލާލަން ބޭނުންކުރަން ފެށިގެން 10% (ބޭނުން ހުށަހަޅާ ގޮތް)	36.1







6.1 .6  
أحكام  
القانون

المادة 102 (ب) في القانون رقم 102 لسنة 2002 (المرادف للمادة 102 من القانون رقم 102 لسنة 2002) التي تنص على أن "لا يجوز أن يكون للموظف في الخدمة المدنية أكثر من وظيفة واحدة في وقت واحد، إلا في الحالات التي يقرها القانون".  
المادة 102 (ب) من القانون رقم 102 لسنة 2002، التي تنص على أن "لا يجوز أن يكون للموظف في الخدمة المدنية أكثر من وظيفة واحدة في وقت واحد، إلا في الحالات التي يقرها القانون".

(ب) أحكام القانون رقم 102 لسنة 2002

7.1 .7  
أحكام  
القانون

المادة 7.1.1 من القانون رقم 102 لسنة 2002، التي تنص على أن "لا يجوز أن يكون للموظف في الخدمة المدنية أكثر من وظيفة واحدة في وقت واحد، إلا في الحالات التي يقرها القانون".

7.1.1 (ب) أحكام القانون رقم 102 لسنة 2002

7.1.2 من القانون رقم 102 لسنة 2002، التي تنص على أن "لا يجوز أن يكون للموظف في الخدمة المدنية أكثر من وظيفة واحدة في وقت واحد، إلا في الحالات التي يقرها القانون".

7.1.3 من القانون رقم 102 لسنة 2002، التي تنص على أن "لا يجوز أن يكون للموظف في الخدمة المدنية أكثر من وظيفة واحدة في وقت واحد، إلا في الحالات التي يقرها القانون".

7.1.4 من القانون رقم 102 لسنة 2002، التي تنص على أن "لا يجوز أن يكون للموظف في الخدمة المدنية أكثر من وظيفة واحدة في وقت واحد، إلا في الحالات التي يقرها القانون".

7.1.5 من القانون رقم 102 لسنة 2002، التي تنص على أن "لا يجوز أن يكون للموظف في الخدمة المدنية أكثر من وظيفة واحدة في وقت واحد، إلا في الحالات التي يقرها القانون".

8.1 .8  
أحكام  
القانون

المادة 8.1 من القانون رقم 102 لسنة 2002، التي تنص على أن "لا يجوز أن يكون للموظف في الخدمة المدنية أكثر من وظيفة واحدة في وقت واحد، إلا في الحالات التي يقرها القانون".

8.2 .8  
أحكام  
القانون

المادة 8.2 من القانون رقم 102 لسنة 2002، التي تنص على أن "لا يجوز أن يكون للموظف في الخدمة المدنية أكثر من وظيفة واحدة في وقت واحد، إلا في الحالات التي يقرها القانون".

9.1 .9  
أحكام  
القانون

المادة 9.1 من القانون رقم 102 لسنة 2002، التي تنص على أن "لا يجوز أن يكون للموظف في الخدمة المدنية أكثر من وظيفة واحدة في وقت واحد، إلا في الحالات التي يقرها القانون".

9.2 .9  
أحكام  
القانون

المادة 9.2 من القانون رقم 102 لسنة 2002، التي تنص على أن "لا يجوز أن يكون للموظف في الخدمة المدنية أكثر من وظيفة واحدة في وقت واحد، إلا في الحالات التي يقرها القانون".



9.3. ከዚህ በፊት የተደረገው ስራ ለማጠናቀቅ ይገባል።  
የሥራው ስራ ለማጠናቀቅ ይገባል።

10.10. የሥራው ስራ ለማጠናቀቅ ይገባል።  
የሥራው ስራ ለማጠናቀቅ ይገባል።

10.10.1 የሥራው ስራ ለማጠናቀቅ ይገባል።  
የሥራው ስራ ለማጠናቀቅ ይገባል።

(ሀ) የሥራው ስራ ለማጠናቀቅ ይገባል።

11.11. የሥራው ስራ ለማጠናቀቅ ይገባል።  
የሥራው ስራ ለማጠናቀቅ ይገባል።

12.12. የሥራው ስራ ለማጠናቀቅ ይገባል።  
የሥራው ስራ ለማጠናቀቅ ይገባል።

13.13. የሥራው ስራ ለማጠናቀቅ ይገባል።  
የሥራው ስራ ለማጠናቀቅ ይገባል።

13.2 የሥራው ስራ ለማጠናቀቅ ይገባል።  
የሥራው ስራ ለማጠናቀቅ ይገባል።

14.14. የሥራው ስራ ለማጠናቀቅ ይገባል።  
የሥራው ስራ ለማጠናቀቅ ይገባል።

14.2 የሥራው ስራ ለማጠናቀቅ ይገባል።  
የሥራው ስራ ለማጠናቀቅ ይገባል።

14.3 የሥራው ስራ ለማጠናቀቅ ይገባል።  
የሥራው ስራ ለማጠናቀቅ ይገባል።







(ס) אגודתו תממנה את המעורבות וההתחייבות של חבריה, והיא תממנה את המעורבות וההתחייבות של חבריה. (ס) המעורבות וההתחייבות של חבריה תממנה את המעורבות וההתחייבות של חבריה.

16.3. אגודתו תממנה את המעורבות וההתחייבות של חבריה.

16.3.1 אגודתו תממנה את המעורבות וההתחייבות של חבריה, והיא תממנה את המעורבות וההתחייבות של חבריה. (תקציב 3 דם רדום)

16.3.2 אגודתו תממנה את המעורבות וההתחייבות של חבריה, והיא תממנה את המעורבות וההתחייבות של חבריה. 500,000 (תקציב 500,000) אגודתו תממנה את המעורבות וההתחייבות של חבריה.

(ס) המעורבות וההתחייבות של חבריה

17.1 המעורבות וההתחייבות של חבריה תממנה את המעורבות וההתחייבות של חבריה. (תקציב 500,000) אגודתו תממנה את המעורבות וההתחייבות של חבריה.

17. המעורבות וההתחייבות של חבריה תממנה את המעורבות וההתחייבות של חבריה.

17.2 אגודתו תממנה את המעורבות וההתחייבות של חבריה, והיא תממנה את המעורבות וההתחייבות של חבריה.

17.3 אגודתו תממנה את המעורבות וההתחייבות של חבריה, והיא תממנה את המעורבות וההתחייבות של חבריה.

17.4 אגודתו תממנה את המעורבות וההתחייבות של חבריה, והיא תממנה את המעורבות וההתחייבות של חבריה.

18.1 אגודתו תממנה את המעורבות וההתחייבות של חבריה, והיא תממנה את המעורבות וההתחייבות של חבריה.

18. המעורבות וההתחייבות של חבריה תממנה את המעורבות וההתחייבות של חבריה.

18.2 אגודתו תממנה את המעורבות וההתחייבות של חבריה, והיא תממנה את המעורבות וההתחייבות של חבריה. 18.1 אגודתו תממנה את המעורבות וההתחייבות של חבריה.

המעורבות וההתחייבות של חבריה תממנה את המעורבות וההתחייבות של חבריה.

18.3 אגודתו תממנה את המעורבות וההתחייבות של חבריה, והיא תממנה את המעורבות וההתחייבות של חבריה.

19.1 אגודתו תממנה את המעורבות וההתחייבות של חבריה, והיא תממנה את המעורבות וההתחייבות של חבריה.

19. המעורבות וההתחייבות של חבריה תממנה את המעורבות וההתחייבות של חבריה.











31. 31  
 32  
 33

31.1 31.1 17-09 17-09  
 13- K/CIR/2018/01  
 17

31.2 31.2 17-09 17-09  
 13-K/CIR/2018/01  
 18

31.3 31.3 17-09 17-09  
 13-K/CIR/2018/01  
 19

31.4 31.4 17-09 17-09

32.1 32.1 17-11 17-11





3 - 3

33.1 33.2 33.3 33.4 33.5

- 33.1 "33.1 33.2 33.3 33.4 33.5" 33.1 33.2 33.3 33.4 33.5
- 33.2 "33.2 33.3 33.4 33.5" 33.2 33.3 33.4 33.5
- 33.3 "33.3 33.4 33.5" 33.3 33.4 33.5
- 33.4 "33.4 33.5" 33.4 33.5
- 33.5 "33.5" 33.5

33.3 33.4 34

- 34.1 34.2 34.3
- 34.2 34.3
- 34.3

34 34

- 35.1 35.2
- 35.1 35.2

35 35 35





36.1. **36. ክለሰ ገንዘብ**  
**ንጥጥረት**  
**ጥገና**  
 ለንጥጥረትና ጥገና አገልግሎት ለሚያስፈልጉ ግለሰቦች ወይንም ለሚያስፈልጉ ተቋማት ገንዘብ ይሰጣል።  
 ለንጥጥረት ጥገና ለሚያስፈልጉ ግለሰቦች ወይንም ለሚያስፈልጉ ተቋማት ገንዘብ ይሰጣል።  
 ለንጥጥረት ጥገና ለሚያስፈልጉ ግለሰቦች ወይንም ለሚያስፈልጉ ተቋማት ገንዘብ ይሰጣል።

37.1. **37. ለግብር እና ለሌሎች የሥራ ግብይት አገልግሎት**

37.2. **ንጥጥረት**  
 ለግብር እና ለሌሎች የሥራ ግብይት አገልግሎት ለሚያስፈልጉ ግለሰቦች ወይንም ለሚያስፈልጉ ተቋማት ገንዘብ ይሰጣል።  
 ለግብር እና ለሌሎች የሥራ ግብይት አገልግሎት ለሚያስፈልጉ ግለሰቦች ወይንም ለሚያስፈልጉ ተቋማት ገንዘብ ይሰጣል።  
 ለግብር እና ለሌሎች የሥራ ግብይት አገልግሎት ለሚያስፈልጉ ግለሰቦች ወይንም ለሚያስፈልጉ ተቋማት ገንዘብ ይሰጣል።

37.3. ለግብር እና ለሌሎች የሥራ ግብይት አገልግሎት ለሚያስፈልጉ ግለሰቦች ወይንም ለሚያስፈልጉ ተቋማት ገንዘብ ይሰጣል።  
 ለግብር እና ለሌሎች የሥራ ግብይት አገልግሎት ለሚያስፈልጉ ግለሰቦች ወይንም ለሚያስፈልጉ ተቋማት ገንዘብ ይሰጣል።  
 ለግብር እና ለሌሎች የሥራ ግብይት አገልግሎት ለሚያስፈልጉ ግለሰቦች ወይንም ለሚያስፈልጉ ተቋማት ገንዘብ ይሰጣል።

38.1. **38. የግብር እና ሌሎች የሥራ ግብይት አገልግሎት**  
**ለግብር**  
 ለግብር እና ለሌሎች የሥራ ግብይት አገልግሎት ለሚያስፈልጉ ግለሰቦች ወይንም ለሚያስፈልጉ ተቋማት ገንዘብ ይሰጣል።

38.2. **የግብር እና ሌሎች የሥራ ግብይት አገልግሎት**  
 ለግብር እና ለሌሎች የሥራ ግብይት አገልግሎት ለሚያስፈልጉ ግለሰቦች ወይንም ለሚያስፈልጉ ተቋማት ገንዘብ ይሰጣል።  
 ለግብር እና ለሌሎች የሥራ ግብይት አገልግሎት ለሚያስፈልጉ ግለሰቦች ወይንም ለሚያስፈልጉ ተቋማት ገንዘብ ይሰጣል።

$$CP \times 0.005 \times LD = \text{ጥገና ጥገና ጥገና}$$
  
 CP (ግብር ደመወድ የግብር): ጥገና ጥገና ጥገና ጥገና  
 LD (ግብር ደመወድ): ጥገና ጥገና ጥገና ጥገና



38.3 38.4 39.1 39.2 40.1

$$CP * 0.0025 * LD = \text{...}$$

CP (CP): ...

LD (LD): ...

38.3 ...

38.4 ...

39.1 ...

39.2 ...

40.1 ...

39. 39.1 39.2

40. 40.1 40.2



41.41  
41.41

41.1. 41.1.   
 41.1.   
 41.1.   
 41.1.   
 41.1.   
 41.1.

42.42  
42.42

42.1. 42.1.   
 42.1.   
 42.1.

43.43  
43.43

43.1. 43.1.   
 43.1.

44.44  
44.44

44.1. 44.1.   
 44.1.

45.45  
45.45

45.1. 45.1.   
 45.1.   
 45.1.

45.2. 45.2.   
 45.2.   
 45.2.





# 1



lhnaifarucouncil



[www.naifaru.gov.mv](http://www.naifaru.gov.mv)



[info@naifaru.gov.mv](mailto:info@naifaru.gov.mv)



6620068

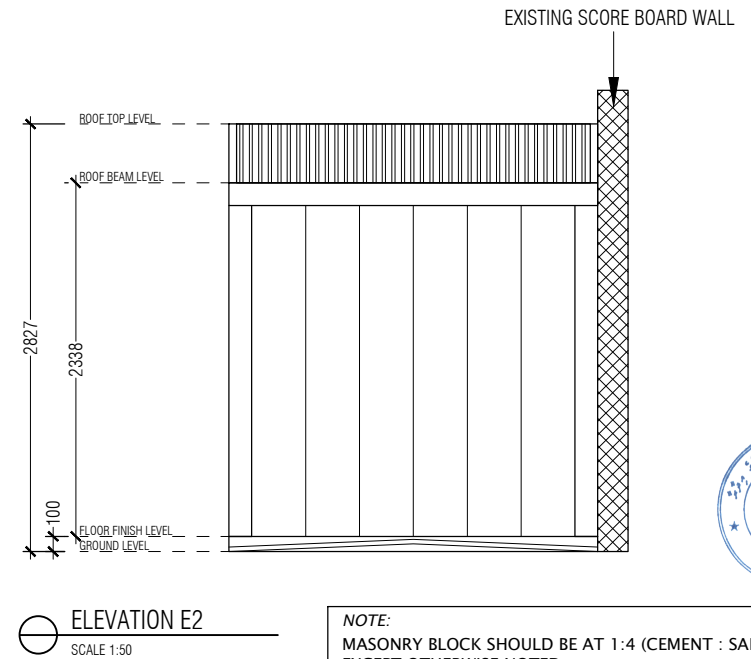
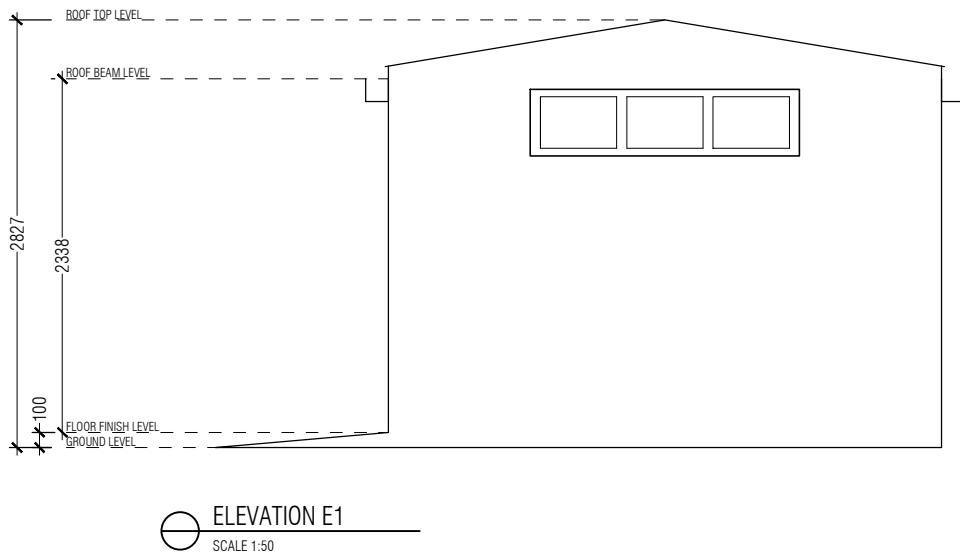
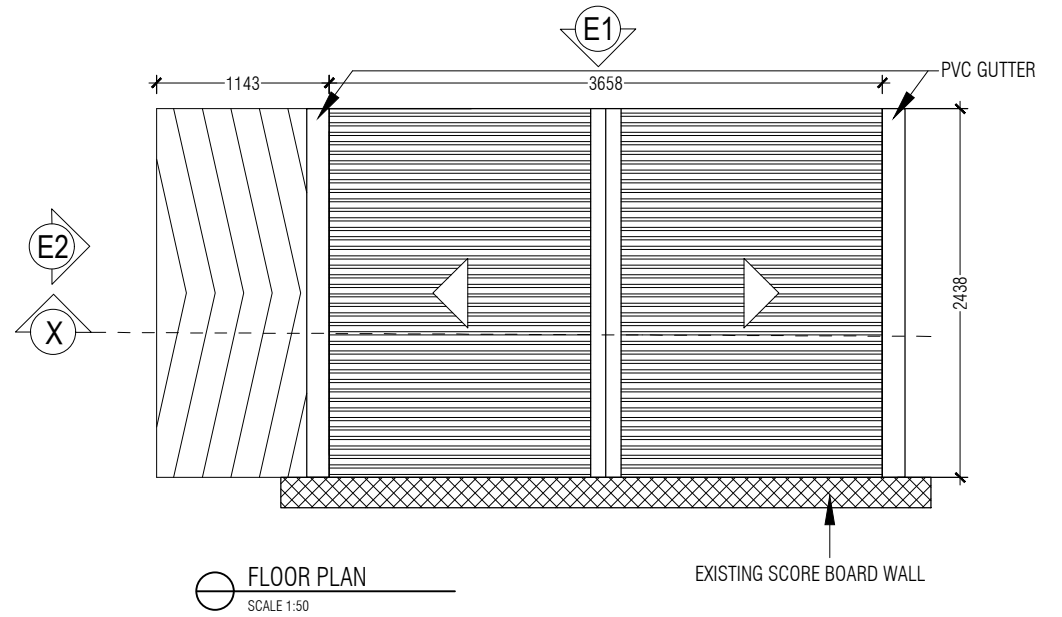
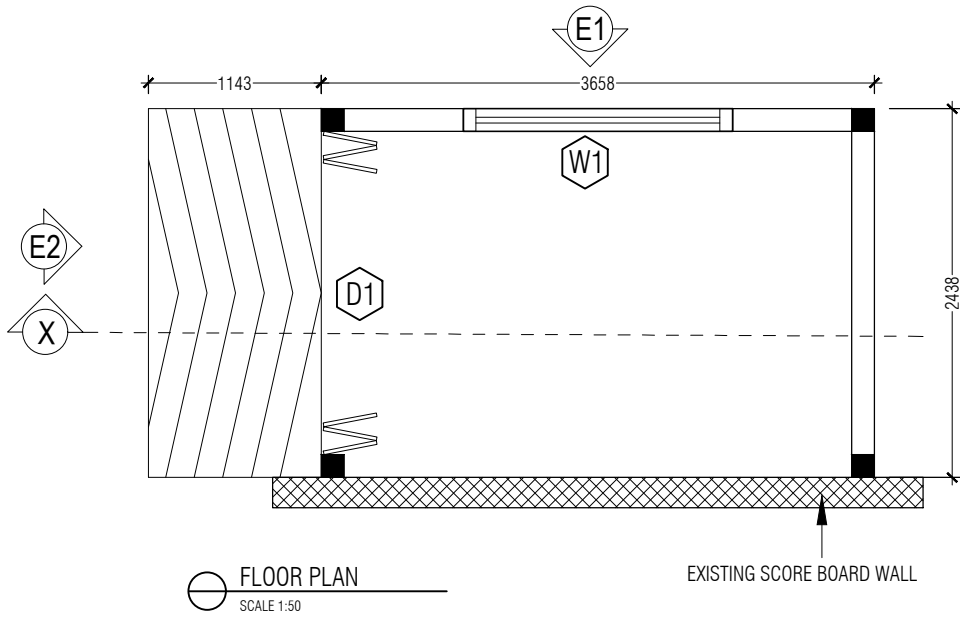

**NOTE:**  
MASONRY BLOCK SHOULD BE AT 1:4 (CEMENT : SAND) RATIO  
EXCEPT OTHERWISE NOTED:

- FOUNDATION PAD & BEAM COVER = 50 mm
- COLUMN COVER = 40 mm
- BEAM COVER = 40 mm
- FLOOR SLAB COVER = 30 mm
- MINIMUM CONCRETE GRADE = 1:2:3



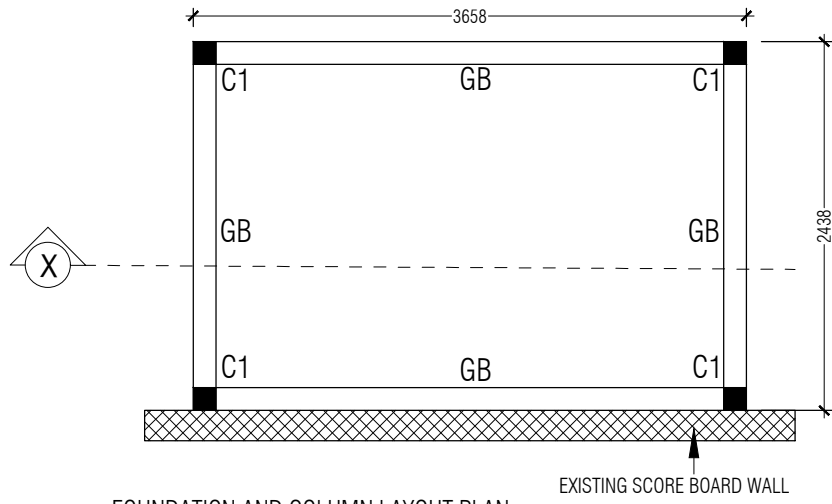

FOUNDATION AND COLUMN LAYOUT PLAN  
SCALE 1:50

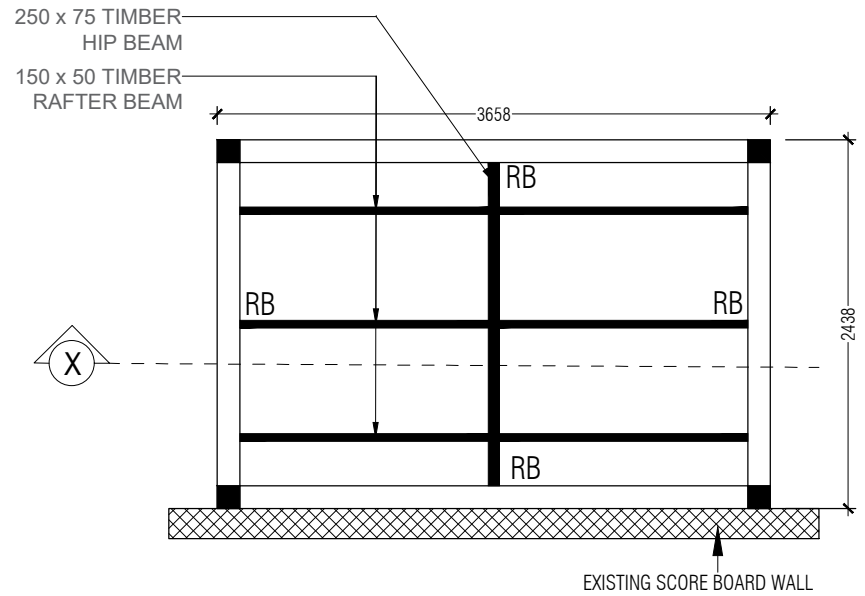

ROOF STRUCTURE PLAN  
SCALE 1:50

**NOTE:**  
MASONRY BLOCKWORK SHALL BE BUILT ABOVE ROOF BEAMS TO RECEIVE RAFTERS. BLOCKWORK SHALL BE PROPERLY BRACED ON ALL SIDES WITH COPING BEAMS AND STIFFENER COLUMNS.  
ALL STRUCTURAL TIMBER TO BE GRADE C30 AND SHALL COMPLY WITH BS 5268  
35 x 50 TIMBER BATTENS @ 600 c/c TO BE FIXED PERPENDICULAR TO RAFTERS (NOT SHOWN)

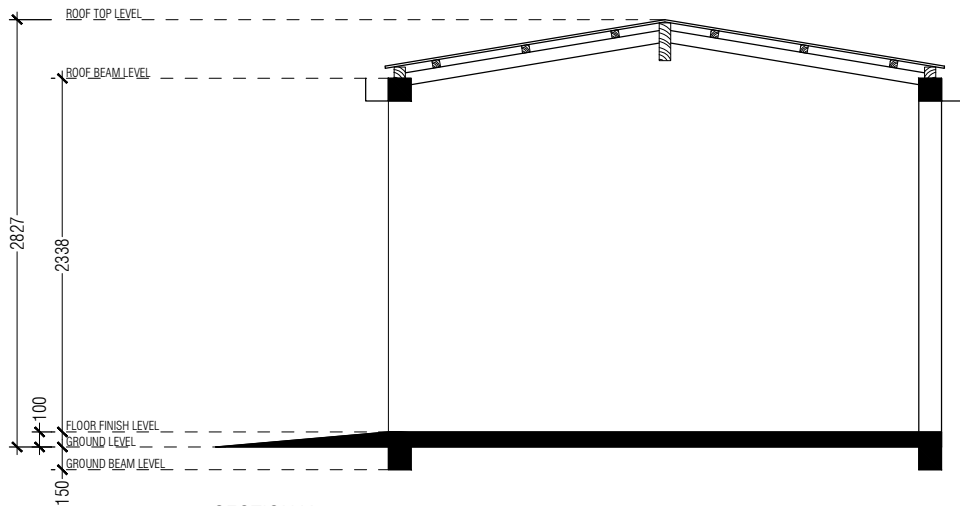

SECTION X  
SCALE 1:50



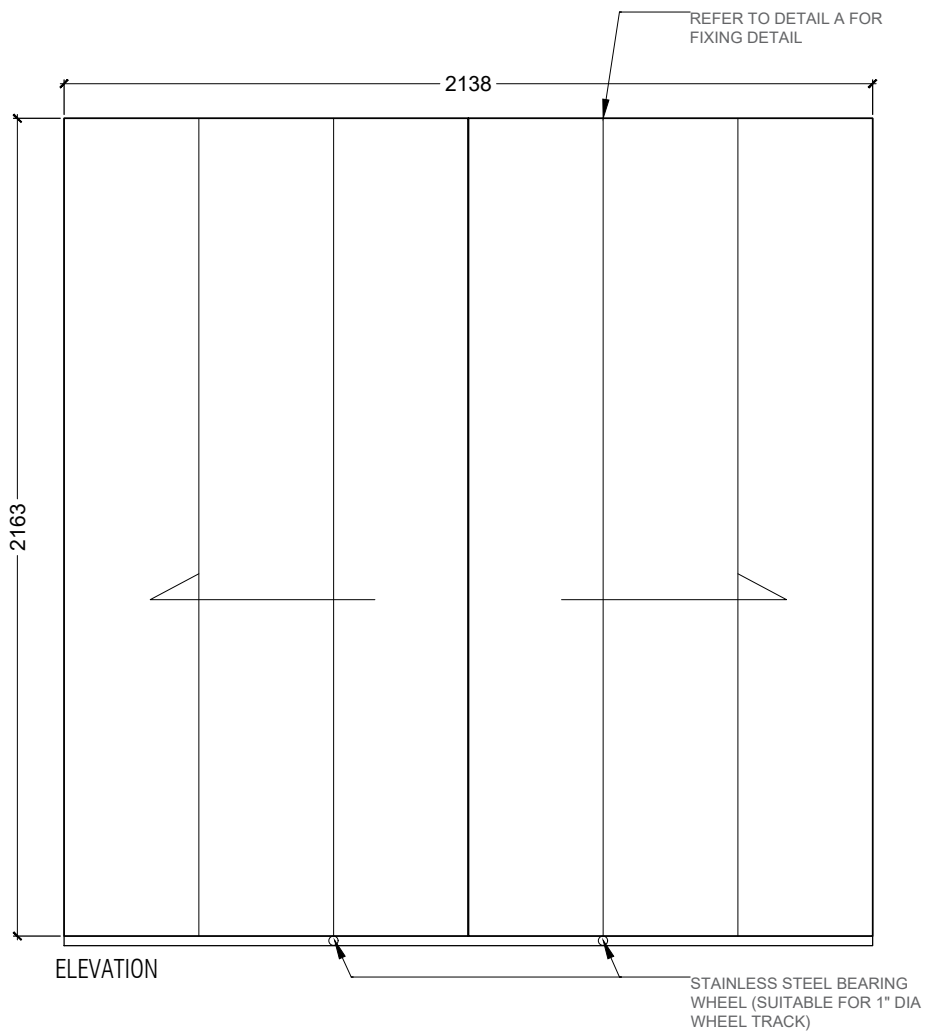

ELEVATION

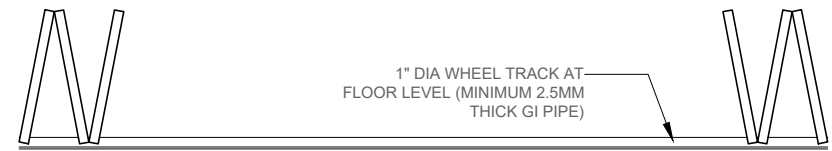

PLAN  
FOLDABLE METAL DOOR (AS SHOWN)

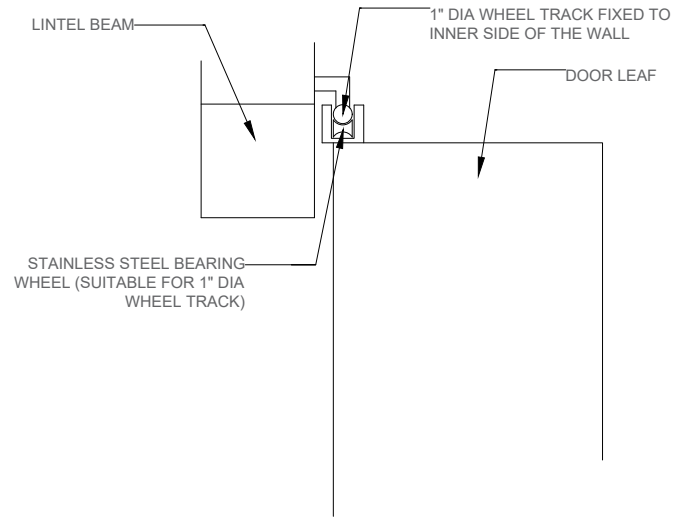

DETAIL A (SCALE 1:10)

**NOTES:**  
STAINLESS STEEL WHEELS SHOULD BE FIXED TO THE DOOR LEAF IN A WAY THAT THE WHEEL TRAVELS SMOOTHLY ON BOTH UPPER AND LOWER WHEEL TRACKS

D1  
SCALE 1:20

CONSTRUCTION OF A STORAGE UNIT AT NAIFARU FOOTBALL GROUND  
SCALE : AS GIVEN





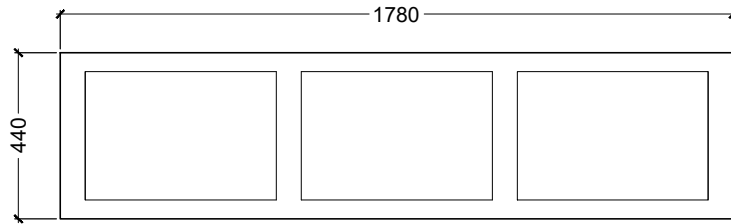

25 Micron Anodized Natural Aluminum Awning Window (TO B FIXED AT 1829MM ABOVE GROUND LEVEL)

W1  
SCALE 1:20

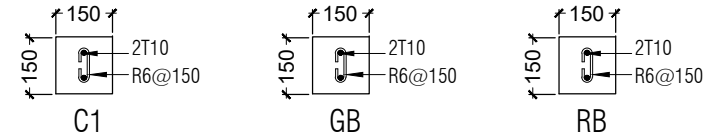

NOTES:  
EXCEPT OTHERWISE NOTED:  
- FOUNDATION PAD & BEAM COVER = 50 mm  
- COLUMN COVER = 40 mm  
- BEAM COVER = 40 mm  
- FLOOR SLAB COVER = 30 mm  
- MINIMUM CONCRETE GRADE = C30

STRUCTURAL DETAILS  
SCALE 1:20







3 ޖަދުވަލު

ސަރުކާރުގެ ސަރަޙައްދުގެ ޖަދުވަލު

1. ސަރުކާރުގެ ސަރަޙައްދުގެ ޖަދުވަލު	
ސަރުކާރު	
ޖަހާ ސަރުކާރުގެ ސަރަޙައްދުގެ ޖަދުވަލު	
ޖަހާ ސަރުކާރުގެ ސަރަޙައްދުގެ ޖަދުވަލު	
ޖަހާ ސަރުކާރުގެ ސަރަޙައްދުގެ ޖަދުވަލު	
ޖަހާ ސަރުކާރުގެ ސަރަޙައްދުގެ ޖަދުވަލު	
ޖަހާ ސަރުކާރުގެ ސަރަޙައްދުގެ ޖަދުވަލު	
ޖަހާ ސަރުކާރުގެ ސަރަޙައްދުގެ ޖަދުވަލު	
ޖަހާ ސަރުކާރުގެ ސަރަޙައްދުގެ ޖަދުވަލު	
ޖަހާ ސަރުކާރުގެ ސަރަޙައްދުގެ ޖަދުވަލު	
2. ސަރުކާރުގެ ސަރަޙައްދުގެ ޖަދުވަލު (ސަރުކާރުގެ ސަރަޙައްދުގެ ޖަދުވަލުގެ ސަރަޙައްދުގެ ޖަދުވަލު)	
ސަރުކާރު	ޖަހާ ސަރުކާރުގެ ސަރަޙައްދުގެ ޖަދުވަލު
ޖަހާ ސަރުކާރުގެ ސަރަޙައްދުގެ ޖަދުވަލު	
ޖަހާ ސަރުކާރުގެ ސަރަޙައްދުގެ ޖަދުވަލު	
ޖަހާ ސަރުކާރުގެ ސަރަޙައްދުގެ ޖަދުވަލު	
ޖަހާ ސަރުކާރުގެ ސަރަޙައްދުގެ ޖަދުވަލު	
ޖަހާ ސަރުކާރުގެ ސަރަޙައްދުގެ ޖަދުވަލު	
ޖަހާ ސަރުކާރުގެ ސަރަޙައްދުގެ ޖަދުވަލު	
ޖަހާ ސަރުކާރުގެ ސަރަޙައްދުގެ ޖަދުވަލު	
ޖަހާ ސަރުކާރުގެ ސަރަޙައްދުގެ ޖަދުވަލު	
3. ސަރުކާރުގެ ސަރަޙައްދުގެ ޖަދުވަލު	
	1
	2
	3
	4
	5
	6
	7
	8
	9
	10



## 4. ބަލާ ބަލާ

### މި ބަލާ ބަލާ ބަލާ ބަލާ ބަލާ

މި ބަލާ ބަލާ ބަލާ ބަލާ ބަލާ			
މި ބަލާ ބަލާ ބަލާ ބަލާ ބަލާ (މި ބަލާ ބަލާ ބަލާ ބަލާ ބަލާ)	މި ބަލާ ބަލާ ބަލާ ބަލާ ބަލާ	މި ބަލާ ބަލާ ބަލާ ބަލާ ބަލާ	#
			1
			2
			3
			4
			5
މި ބަލާ ބަލާ			

މި ބަލާ ބަލާ ބަލާ ބަލާ ބަލާ

---

---



---



---



---



---



---



---



---

މި ބަލާ ބަލާ ބަލާ ބަލާ ބަލާ:

މި ބަލާ ބަލާ ބަލާ ބަލާ ބަލާ:

މި ބަލާ ބަލާ ބަލާ ބަލާ ބަލާ:

މި ބަލާ ބަލާ ބަލާ ބަލާ ބަލާ:

މި ބަލާ ބަލާ ބަލާ ބަލާ ބަލާ:

މި ބަލާ ބަލާ ބަލާ ބަލާ ބަލާ:

މި ބަލާ ބަލާ ބަލާ ބަލާ ބަލާ:



3 (މަސްއަދު) ގަދަދު ރާއްޖޭގެ ސަރުކާރުގެ ޖަދުވަލު ސަރުކާރުގެ ޖަދުވަލު

ޖަދުވަލު 1 ގަދަދު ރާއްޖޭގެ ސަރުކާރުގެ ޖަދުވަލު ސަރުކާރުގެ ޖަދުވަލު (މަސްއަދު ޖަދުވަލު ގަދަދު ރާއްޖޭގެ ސަރުކާރުގެ ޖަދުވަލު ސަރުކާރުގެ ޖަދުވަލު)				
#	ސަރުކާރުގެ ނަންބަރު	ސަރުކާރުގެ ނަންބަރު	ސަރުކާރުގެ ނަންބަރު	ސަރުކާރުގެ ނަންބަރު
1.				
2.				
3.				
4.				
5.				
6.				
7.				
8.				
9.				
10.				

ޖަދުވަލު 2 ގަދަދު ރާއްޖޭގެ ސަރުކާރުގެ ޖަދުވަލު ސަރުކާރުގެ ޖަދުވަލު

ގަދަދު ރާއްޖޭގެ ސަރުކާރުގެ ޖަދުވަލު ސަރުކާރުގެ ޖަދުވަލު  
 ސަރުކާރުގެ ޖަދުވަލު  
 ސަރުކާރުގެ ޖަދުވަލު  
 ސަރުކާރުގެ ޖަދުވަލު  
 ސަރުކާރުގެ ޖަދުވަލު  
 ސަރުކާރުގެ ޖަދުވަލު  
 ސަރުކާރުގެ ޖަދުވަލު  
 ސަރުކާރުގެ ޖަދުވަލު  
 ސަރުކާރުގެ ޖަދުވަލު





## Form of Tender Security (Bank Guarantee)

The Issuing Bank shall fill in this Bank Guarantee Form in accordance with the instructions indicated.

..... {Bank's Name, and Address of Issuing Branch or Office}

**Beneficiary:** {Name and Address of Employer}

**Date:**

**TENDER GUARANTEE No.:** \_\_\_\_\_

We have been informed that \_\_\_\_\_ {name of the Tenderer} (hereinafter called "the Tenderer") has submitted to you its Tender dated \_\_\_\_\_ (hereinafter called "the Tender") for the execution of \_\_\_\_\_ {name of contract} under Invitation for Tenders No. \_\_\_\_\_ ("the IFB").

Furthermore, we understand that, according to your conditions, Tenders must be supported by a Tender guarantee.

At the request of the Tenderer, we \_\_\_\_\_ {name of Bank} hereby irrevocably undertake to pay you any sum or sums not exceeding in total an amount of \_\_\_\_\_ [amount in figures] (\_\_\_\_\_)

[amount in words] upon receipt by us of your first demand in writing accompanied by a written statement stating that the Tenderer is in breach of its obligation(s) under the Tender conditions, because the Tenderer:

(a) has withdrawn its Tender during the period of Tender validity specified by the Tenderer in the Form of Tender; or

(b) having been notified of the acceptance of its Tender by the Employer during the period of Tender validity, (i) fails or refuses to execute the Contract Form, if required, or (ii) fails or refuses to furnish the performance security, in accordance with the ITB.

This guarantee will expire: (a) if the Tenderer is the successful Tenderer, upon our receipt of copies of the contract signed by the Tenderer and the performance security issued to you upon the instruction of the Tenderer; and (b) if the Tenderer is not the successful Tenderer, upon the earlier of (i) our receipt of a copy your notification to the Tenderer of the name of the successful Tenderer; or (ii) {insert date} twenty-eight days after the expiration of the Tenderer's Tender.

Consequently, any demand for payment under this guarantee must be received by us at the office on or before that date.

This guarantee is subject to the Uniform Rules for Demand Guarantees, ICC Publication No. 458

[Signature(s)]





## Performance Security

[The issuing bank, as requested by the successful Contractor, shall fill in this form in accordance with the instructions indicated]

**Date:** [insert date (as day, month, and year)]

**Title of the procurement:** [Insert general title of the procurement]

**Procurement Reference No:** [insert reference]

**Bank's Branch or Office:** [insert complete name of Guarantor]

**Beneficiary:** [insert complete name of Employer/Procuring Entity]

**Performance Guarantee No:**

We have been informed that ..... [name of the Contractor], (hereinafter called "the Contractor") has entered into Contract No. . . . . [procurement reference number of the Contract]. dated [insert day and month], [insert year], with you, for the execution of ..... [name of contract and brief description of Works] (hereinafter called "the Contract").

Furthermore, we understand that, according to the conditions of the Contract, a performance guarantee is required.

At the request of the Contractor, we ..... [name of the Bank] hereby irrevocably undertake to pay you any sum or sums not exceeding in total an amount of ..... [name of the currency and amount in figures] 1.... (. . . . . [amount in words]) such sum being payable in the types and proportions of currencies in which the Contract Price is payable, upon receipt by us of your first demand in writing accompanied by a written statement stating that the Contractor is in breach of its obligation(s) under the Contract, without your needing to prove or to show grounds for your demand or the sum specified therein.

This guarantee shall expire, no later than the .... day of . . . . ., . . . . . 2, and any demand for payment under it must be received by us at this office on or before that date. The Guarantor agrees to a one-time extension of this guarantee for a period not to exceed .... [six months] [one year], in response to the Employer's written request for such extension, such request to be presented to the Guarantor before the expiry of the guarantee.

This guarantee is subject to the Uniform Rules for Demand Guarantees, ICC Publication No. 458, except that subparagraph (ii) of Sub-article 20(a) is hereby excluded.

..... [Seal of Bank and Signature(s)]

### Note: -

All italicized text is for guidance on how to prepare this demand guarantee and shall be deleted from the final document.

**1** The Guarantor shall insert an amount representing the percentage of the Contract Price specified in the Contract and denominated either in the currency (ies) of the Contract or a freely convertible currency acceptable to the Employer.

**2** Insert the date twenty-eight days after the expected completion date. The Employer should note that in the event of an extension of the time for completion of the Contract, the Employer would need to request an extension of this guarantee from the Guarantor. Such request must be in writing and must be made prior to the expiration date established in the guarantee.



## Advance Payment Security

[The bank, as requested by the successful Contractor, shall fill in this form in accordance with the instructions indicated.]

Date: [insert date (as day, month, and year)]

Title of the Procurement: [Insert general title of the procurement]

Procurement Reference No: [insert reference]

[Issuing bank's letterhead]

Beneficiary: [insert legal name and address of Procuring Entity]

ADVANCE PAYMENT GUARANTEE No.: [insert Advance Payment Guarantee no.]

Advance Payment Guarantee No:

We have been informed that ..... [name of the Contractor] (hereinafter called "the Contractor") has entered into Contract No..... [procurement reference number of the Contract], dated [insert day and month], [insert year] with you, for the execution of ..... [name of contract and brief description of Works] (hereinafter called "the Contract").

Furthermore, we understand that, according to the Conditions of the Contract, an advance payment in the sum ..... [name of the currency and amount in figures] 1 (..... [amount in words]) is to be made against an advance payment guarantee.

At the request of the Contractor, we ..... [name of the Bank]. hereby irrevocably undertake to pay you any sum or sums not exceeding in total an amount of ..... [name of the currency and amount in figures] \* (..... [amount in words]) upon receipt by us of your first demand in writing accompanied by a written statement stating that the Contractor is in breach of its obligation under the Contract because the Contractor used the advance payment for purposes other than the costs of mobilization in respect of the Works.

It is a condition for any claim and payment under this guarantee to be made that the advance payment referred to above must have been received by the Contractor on its account number ..... [Contractor's account number]. at ..... [name and address of the Contractor's Bank].

The maximum amount of this guarantee shall be progressively reduced by the amount of the advance payment repaid by the Contractor as indicated in copies of interim statements or payment certificates which shall be presented to us. This guarantee shall expire, at the latest, upon our receipt of a copy of the interim payment certificate indicating that eighty (80) percent of the Contract Price has been certified for payment, or on the ..... day of ..... 2, whichever is earlier. Consequently, any demand for payment under this guarantee must be received by us at this office on or before that date. The Guarantor agrees to a one-time extension of this guarantee for a period not to exceed [six months] [one year], in response to the Employer's written request for such extension, such request to be presented to the Guarantor before the expiry of the guarantee.

This guarantee is subject to the Uniform Rules for Demand Guarantees, ICC Publication No. 458.

..... [Seal of Bank and Signature(s)] .....

### Note:

All italicized text is for guidance in preparing this demand guarantee and shall be deleted from the final document.

1 The Guarantor shall insert an amount representing the amount of the advance payment denominated either in the currency(ies) of the advance payment as specified in the Contract, or in a freely convertible currency acceptable to the Employer.

2 Insert the expected expiration date of the Time for Completion. The Employer should note that in the event of an extension of the time for completion of the Contract, the Employer would need to request an extension of this guarantee from the Guarantor. Such request must be in writing and must be made prior to the expiration date established in the guarantee.

