

ARCHITECTURAL AND STRUCTURAL DRAWINGS OF

PROPOSED SINGLE STOREY BUILDING AT
COUNCIL BUILDING
GDH. RATHAFANDHOO

(AMENDMENT DRAWINGS)

For Local Government Authority

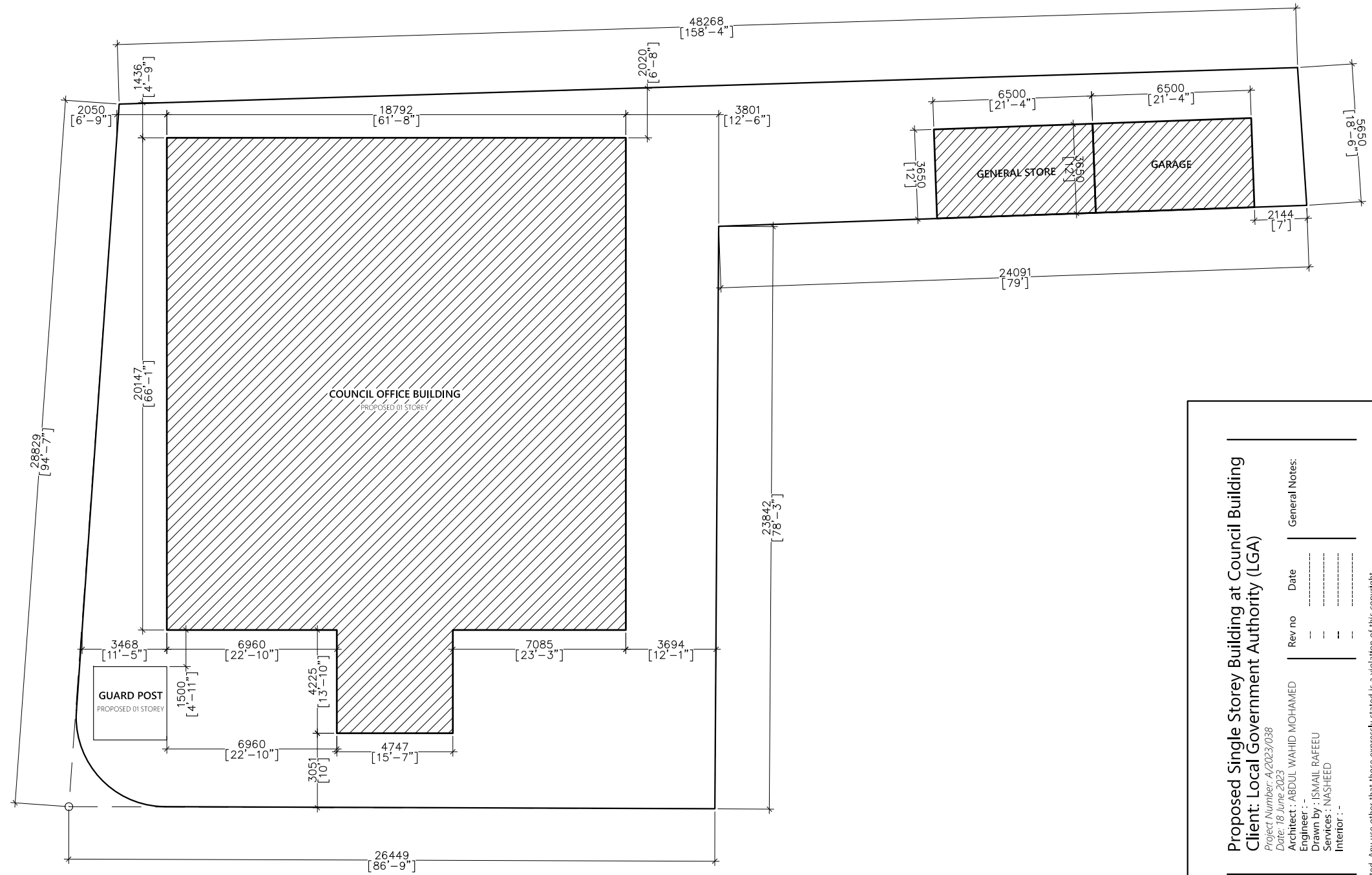

SITE PLAN

1:200

Proposed Single Storey Building at Council Building
Client: Local Government Authority (LGA)

Project Number: A/2023/038
 Date: 18 June 2023
 Architect: ABDUL WAHID MOHAMED
 Engineer: ISMAIL RAFFEU
 Drawn by: NASHIED
 Interior: -

Rev no	Date	General Notes:
-	-	-
-	-	-
-	-	-



ARCON PRIVATE LIMITED
 t: +9603320203 m: +9607790203
 e: info@arcon.com.mv
 w: www.arcon.com.mv
 Ground floor, M. Salar Highway,
 Sabudheli Magu, Male*

Title:
 SITE PLAN
 Page: A - 01/07

The contents of these drawings remain as a property of Arcon Private Limited. Any use other than those expressly stated is a violation of this copyright



- Wall Legend:**
- 150mm thick masonry blocks with 20mm plaster on exterior and 12mm plaster on interior
 - 100mm thick dry wall
- Wall Finish:**
- Internal Wall Finish: Easy to wash odour-less Nippon paint Ivory White (code: 816)
- External Wall Finish: Weatherboard guard Nippon September Cream (code: 0838)
- Toilet and shower walls: 300x300mm ceramic wall lanka tiles up to ceiling height with tile adhesive, use joint filler of appropriate color for grouting joints between tiles
- Floor Finish:**
- Floor Finishes: 600x600mm homogenous floor tiles with tile adhesive unless specified
- Toilet Floor Finishes: 300x300mm homogenous non skid floor tiles with tile adhesive unless specified
- Notes:**
- FFL of balconies and toilets should be 25mm lower than the FFL of respective floors
- Water proofing to be applied in toilets, balconies and roof terrace prior to tiling

Proposed Single Storey Building at Council Building
Client: Local Government Authority (LGA)

Project Number: A/2023/038
 Date: 18 June 2023
 Architect: ABDUL WAHID MOHAMED
 Engineer: ISMAIL RAFFEU
 Services: NASHHEED
 Interior: -

General Notes:

Rev no	Date

ARCON PRIVATE LIMITED
 t: +9603320203 m: +9607790203
 e: info@arcon.com.mv
 w: www.arcon.com.mv
 Ground floor, M. Salar Highway,
 Sabudheli Magu, Male'

Title:

FLOOR PLAN

Page: A - 02/07

GROUND FLOOR PLAN AMENDMENTS

1:100

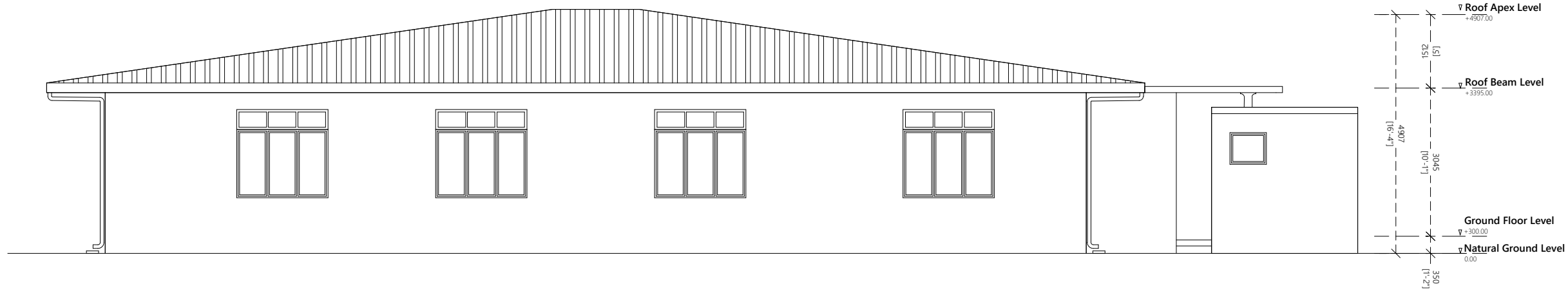

ELEVATION E1

1:100

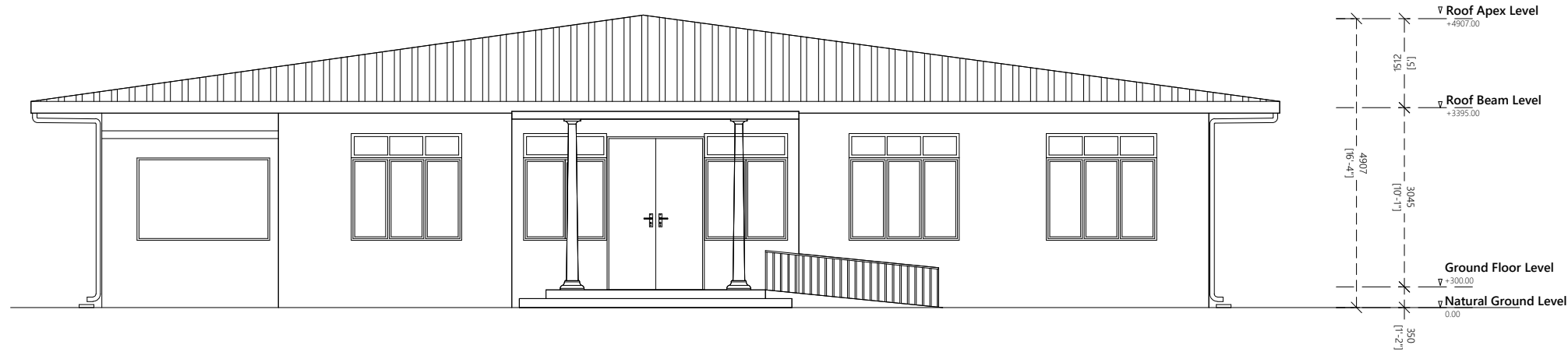

ELEVATION E2

1:100

Proposed Single Storey Building at Council Building
Client: Local Government Authority (LGA)

Project Number: RI/2020/000

Date: 23 December 2020

Architect: MARIYAM IRASHA SHAREEF

Engineer: MOHAMED YASBIQ ISMAIL

Services: -

Interior: -

General Notes:

Rev no

Date

RIYAN PRIVATE LIMITED
 t: +9603315049 f: +9603310776
 e: info@riyan.com.mv
 w: www.riyan.com.mv
 3rd floor, H. Azum, Ameenemagu, Male'

Title:

Elevation E1 & E2

Page: A-04/07

The contents of these drawings remain as a property of Riyan Private Limited. Any use other than those expressly stated is a violation of this copyright.

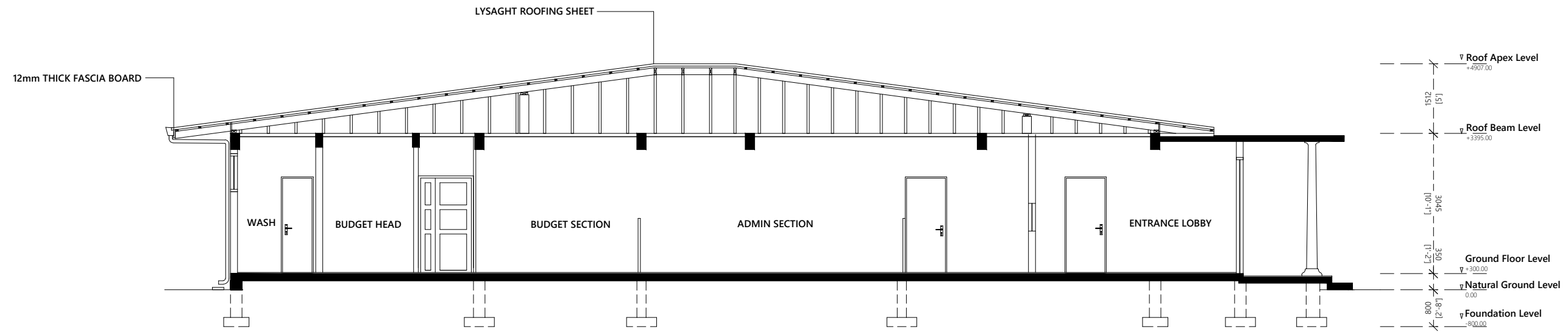

SECTION X-X

1:100

Proposed Single Storey Building at Council Building
Client: Local Government Authority (LGA)

Project Number: RI/2020/000
 Date: 23 December 2020
 Architect: MARIYAM IRASHA SHAREEF
 Engineer: MOHAMED YASBIQ ISMAIL
 Services: -
 Interior: -

Rev no	Date	General Notes
-	-	-
-	-	-
-	-	-



RYAN PRIVATE LIMITED
 t: +9603315049 f: +9603310776
 e: info@riyan.com.mv
 w: www.riyan.com.mv
 3rd floor, H. Azum, Ameenemagu, Male'

The contents of these drawings remain as a property of RYAN Private Limited. Any use other than those expressly stated is a violation of this copyright.

Door ID	D1	D2	D3	D4	D5	D6
Plan view						
Elevation view						
FFL						
Frame material	Aluminum powder coated	Solid timber Varnished	Solid timber Varnished	PVC	Aluminum powder coated	Solid timber Varnished
Panel material	Aluminum powder coated with glass panels	Solid core timber varnished	Solid core timber varnished	PVC	Aluminum powder coated with glass panels	Solid core timber varnished
Openable area	4.08	2.3	1.73	1.32	2.3	1.42

Door ID	W1	W2
Plan view		
Elevation view		
FFL		
Frame material	Aluminium Black Powder Coated	Aluminium Black Powder Coated
Panel material	Reflective glass	Reflective glass
Openable area	2.23	2.88

General Notes:

Dimensions shown on DWG indicate effective openings of frame

All frame depths are 100mm
All dor panel thicknesses are 35mm
All window manel thickness are 25mm
All frame edges shall be trimmed 3mm

All wooden components should be wood stained finish

All glazing should be of 6mm unless specified

External units must comply the following weather conditions:-
Wind pressure: 200 kg/sqm
Water tightness: 25 kg/sqm

All external frames / wall joints must be sealed with silicon sealant and the wedges trimmed with 12X12mm hardwood beading fixed to frames by brass nails

All hardware should be provided for the performance of al functions of the units

Hinges shall confirm to
1. Door size more than 700X1900mm
WD: 125mm X2 sets
SD: 150mm X3 sets
2. Door size less than 700X1900mm
WD: 100mm X2 sets
SD: 125mm X2 sets

Locks shall be cylindrical with master key sets

Door knobs shall be 1000mm above FFL

DOOR AND WINDOW SCHEDULE 01

1:50

Proposed Single Storey Building at Council Building
Client: Local Government Authority (LGA)

Project Number: RI/2020/000
Date: 23 December 2020
Architect: MARIVAM IRASHA SHAREEF
Engineer: MOHAMED YASBIQ ISMAIL
Services: Interior

Rev no	Date	General Notes:
---	---	---
---	---	---
---	---	---



RYAN PRIVATE LIMITED
t: +9603315049 f: +9603310776
e: info@riyan.com.mv
w: www.riyan.com.mv
3rd floor, H. Azum, Ameenemagui, Male'

Title: Door & Window Schedule 1
Page: A-06/07

The contents of these drawings remain as a property of RYAN Private Limited. Any use other than those expressly stated is a violation of this copyright

Door ID	GT
Plan view	
Elevation view	
FFL	
Frame material	Steel gate frame
Panel material	Steel frame with steel panels as shown on elevation view
Quantity	2nos

Door ID	W3	W4
Plan view		
Elevation view		
FFL		
Frame material	Aluminium Black Powder Coated	Aluminium Black Powder Coated
Panel material	Reflective glass	Reflective glass
Openable area	0.41	0.00

General Notes:

Dimensions shown on DWG indicate effective openings of frame

All frame depths are 100mm
All dor panel thicknesses are 35mm
All window panel thickness are 25mm
All frame edges shall be trimmed 3mm

All wooden components should be wood stained finish

All glazing should be of 6mm unless specified

External units must comply the following weather conditions:-
Wind pressure: 200 kg/sqm
Water tightness: 25 kg/sqm

All external frames / wall joints must be sealed with silicon sealant and the wedges trimmed with 12X12mm hardwood beading fixed to frames by brass nails

All hardware should be provided for the performance of all functions of the units

Hinges shall confirm to

- Door size more than 700X1900mm
WD: 125mm X2 sets
SD: 150mm X3 sets
- Door size less than 700X1900mm
WD: 100mm X2 sets
SD: 125mm X2 sets

Locks shall be cylindrical with master key sets

Door knobs shall be 1000mm above FFL

DOOR AND WINDOW SCHEDULE 02

1:50

Proposed Single Storey Building at Council Building
Client: Local Government Authority (LGA)

Project Number: RI/2020/000
Date: 23 December 2020

Architect: MARIYAM IRASHA SHAREEF

Engineer: MOHAMED YASBIQ ISMAIL

Services: Interior

General Notes:

Rev no

Date



RIYAN PRIVATE LIMITED

t : +9603315049 f : +9603310776
e : info@riyan.com.mv
w : www.riyan.com.mv
3rd floor, H. Azum, Ameenemogaa, Male'

Title:

Door & Window
Schedule - 2

Page: A-07/07

The contents of these drawings remain as a property of Riyan Private Limited. Any use other than those expressly stated is a violation of this copyright

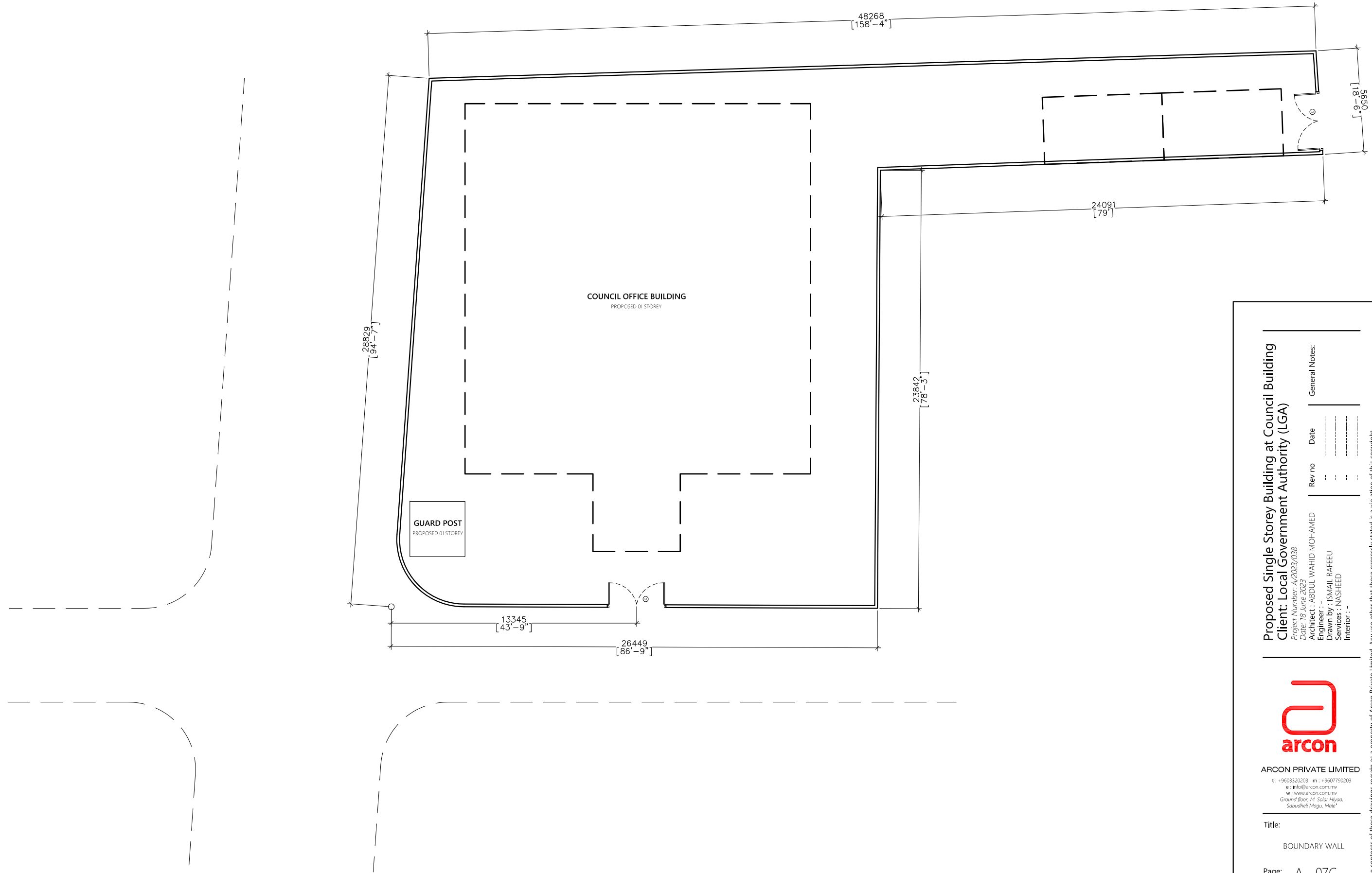

BOUNDARY WALL LAYOUT

1:200

Proposed Single Storey Building at Council Building
Client: Local Government Authority (LGA)

Project Number: A/2023/038
 Date: 18 June 2023
 Architect: ABDUL WAHID MOHAMED
 Engineer: ISMAIL RAFFEU
 Drawn by: NASHIED
 Interior: -

Rev no	Date	General Notes:
-	-	-
-	-	-
-	-	-



ARCON PRIVATE LIMITED
 t: +9603320203 m: +9607790203
 e: info@arcon.com.mv
 w: www.arcon.com.mv
 Ground floor, M. Salar Highway,
 Sabudheli Magu, Male*

Title:
 BOUNDARY WALL

Page: A - 07C

The contents of these drawings remain as a property of Arcon Private Limited. Any use other than those expressly stated is a violation of this copyright

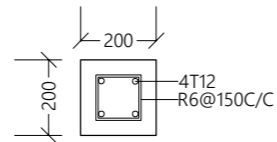

BC

BOUNDARY WALL COLUMN @ maximum distance 5000mm C/C

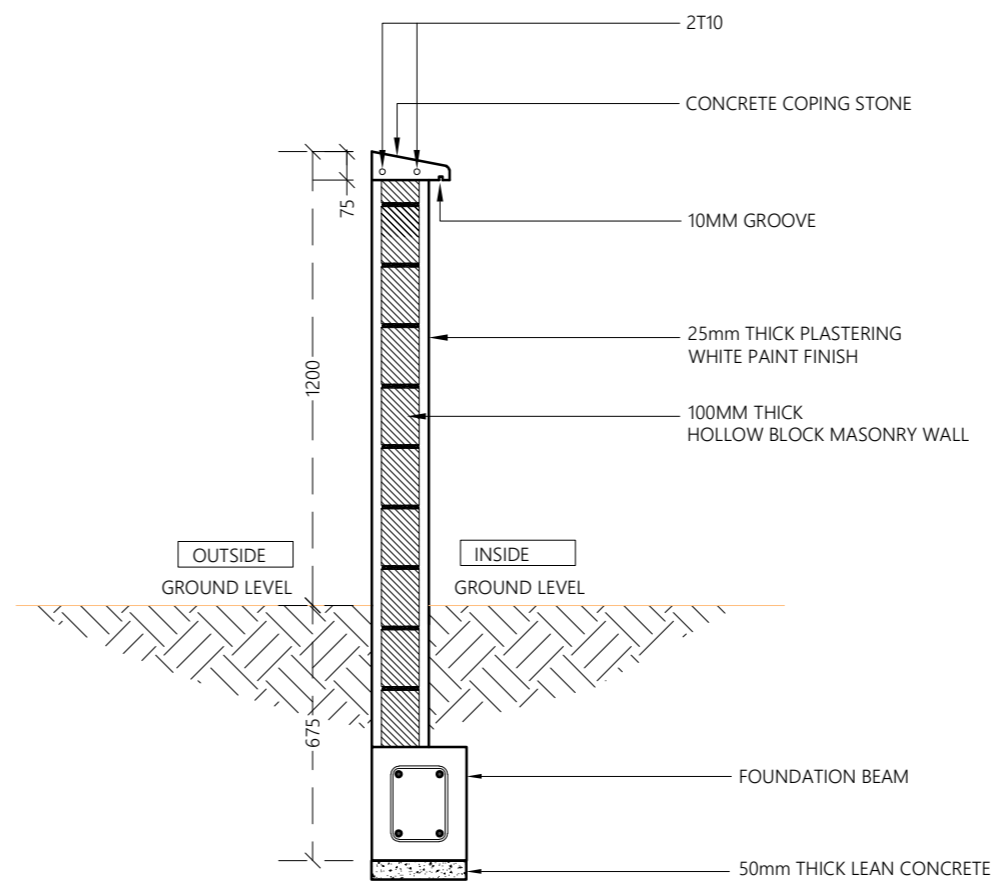

PROPOSED 01 STOREY BUILDING AT
**SINGLE STOREY
COUNCIL OFFICE**

Sub Title:
COUNCIL PSI PROJECT

Client:
**LOCAL GOVERNMENT
AUTHORITY**

December 2019

Architect: **Mohamed Hassaan**
Engineer: **Ihsaan Waheed**
Drawn By: **Hussain Maathin**



T: +960 333 3528 | E: info@epochassociates
W: www.epochassociates.com | M: Ahiyasdhoohuge
Fareedhee Magu Male' Republic of Maldives

Rev:	Page:
---	---
---	A07A

TYPICAL BOUNDARY WALL DETAIL

1:20

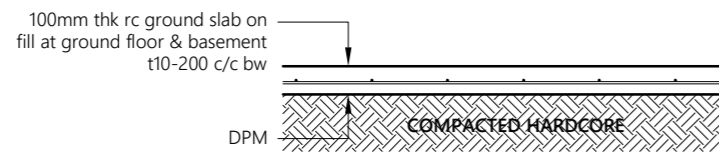

Note:

- All cover blocks shall be casted using grade C25/30 concrete with 5-10mm aggregates
- For slab, rebar spacer chairs spacing shall be minimum 1m spacing or 1 no. per 1 sqm

TYPICAL GROUND SLAB DETAIL

1:20

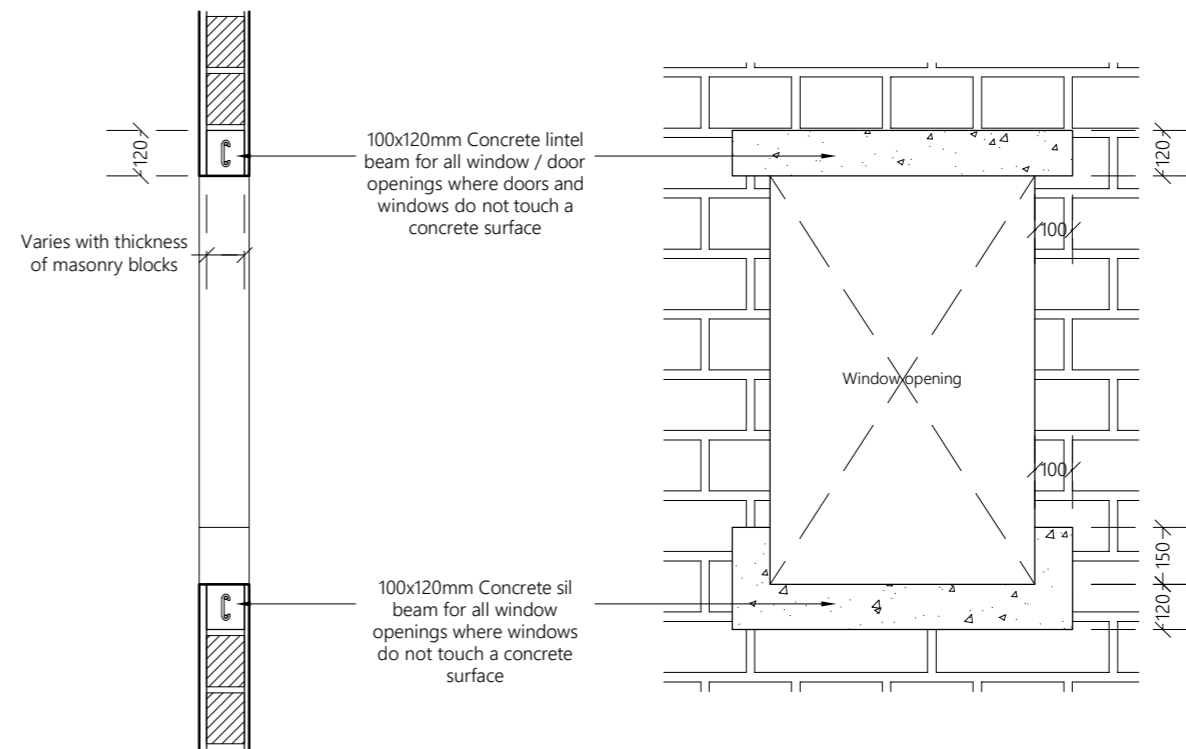

TYPICAL OPENING DETAIL

1:20

**PROPOSED 01 STOREY BUILDING AT
SINGLE STOREY
COUNCIL OFFICE**

Sub Title:
COUNCIL PSI PROJECT

Client:
**LOCAL GOVERNMENT
AUTHORITY**

December 2019

Architect: **Mohamed Hassaan**
Engineer: **Ihsaan Waheed**
Drawn By: **Hussain Maathin**



T: +960 333 3528 | E: info@epochassociates
W: www.epochassociates | A: H. Ahgasbiyohuge
Fareedhee Magu Male' Republic of Maldives

Rev:
Page: **A07B**

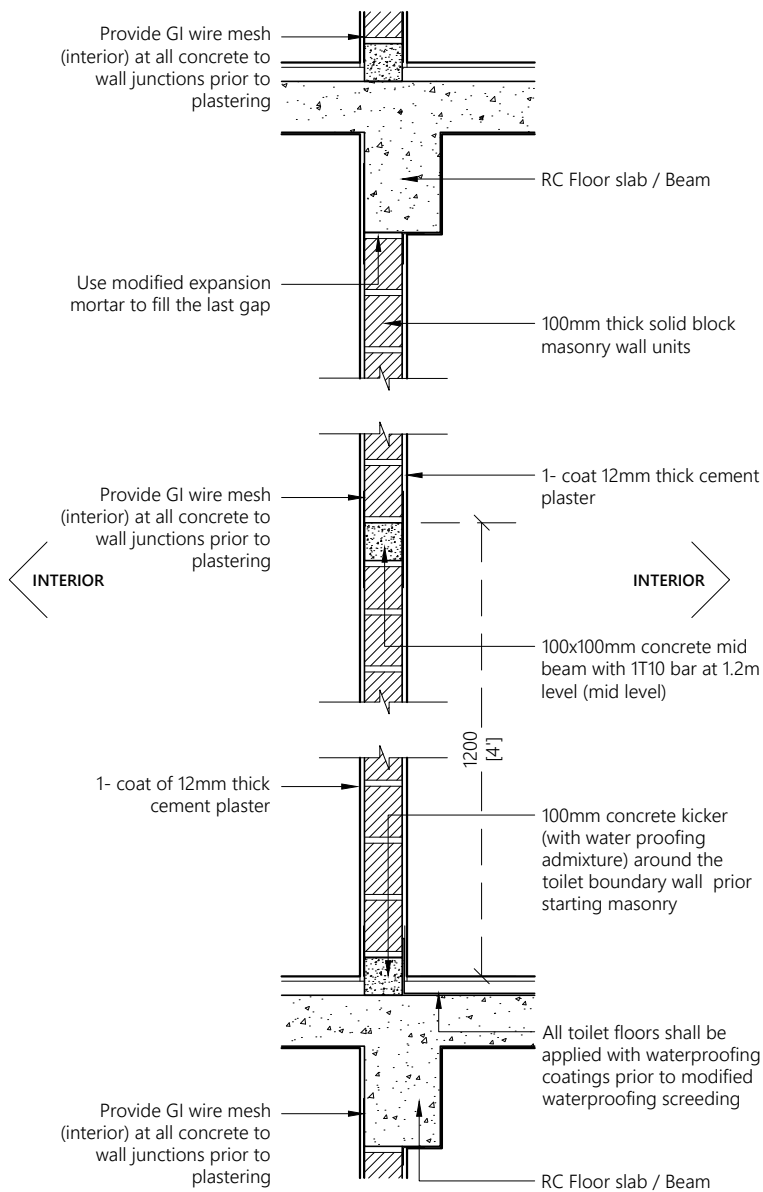
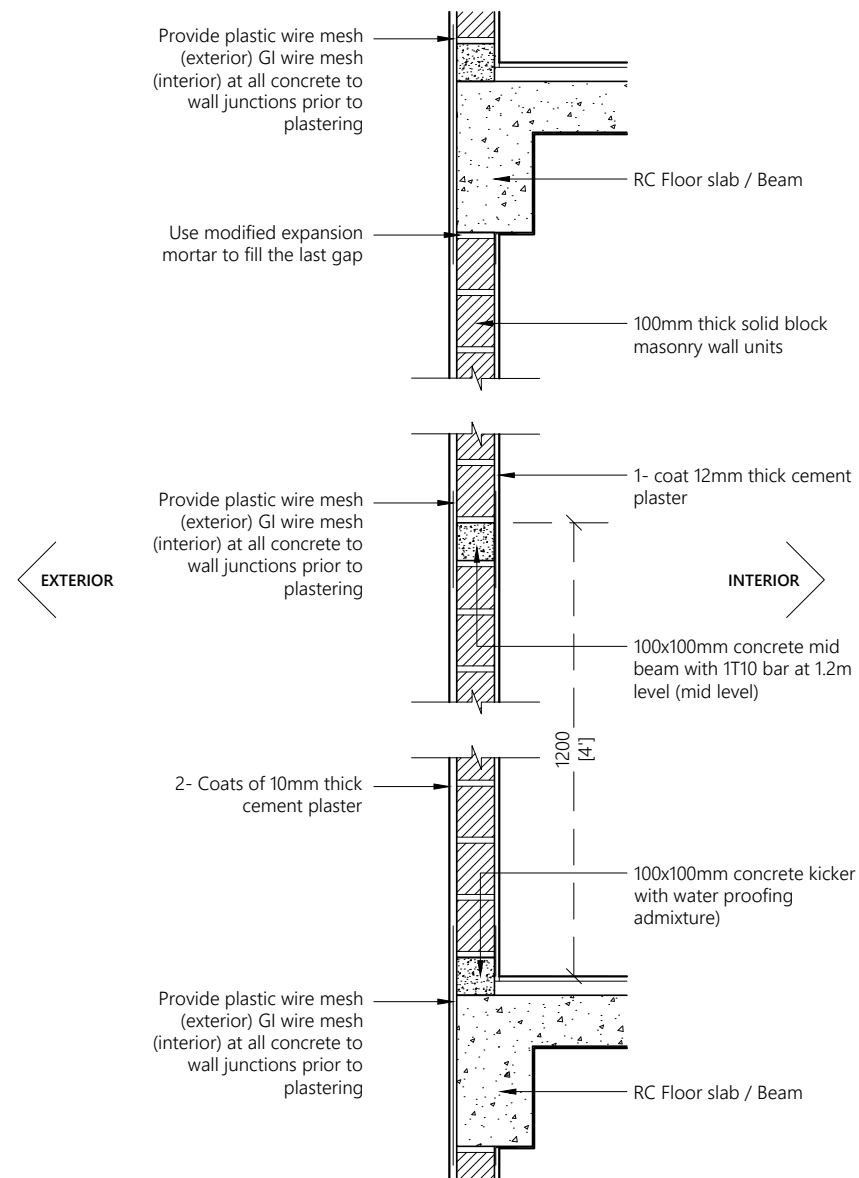

Note:

- Concrete surfaces shall be thoroughly cleaned with water & applied with mastercast 141 or equivalent bonding mortar prior to plastering.
- Plastering mortar mix shall be 1:4 (cement: sand) ratio.
- Plaster mix shall be modified using fibre wool & mastercast 141 or equivalent plasticisers as per manufacturer's specification.
- Height of placing blocks shall be maximum 1.2m per day.
- After initial coat of plastering, water curing shall be provided for minimum 3 days & after final coat water curing shall be provided for 7 days.

TYPICAL WALL CONSTRUCTION DETAIL

PROPOSED 01 STOREY BUILDING AT
SINGLE STOREY COUNCIL OFFICE

Sub Title:
COUNCIL PSI PROJECT

Client:
LOCAL GOVERNMENT AUTHORITY

December 2019

Architect: Mohamed Hassaan
Engineer: Ihsaan Waheed
Drawn By: Hussain Maathin



T: +960 333 3528 E: info@epoch.associates
W: www.epoch.associates A: M. Ahnagashohuge,
Fareedhee Magu Male' Republic of Maldives

Rev: Page:
A08

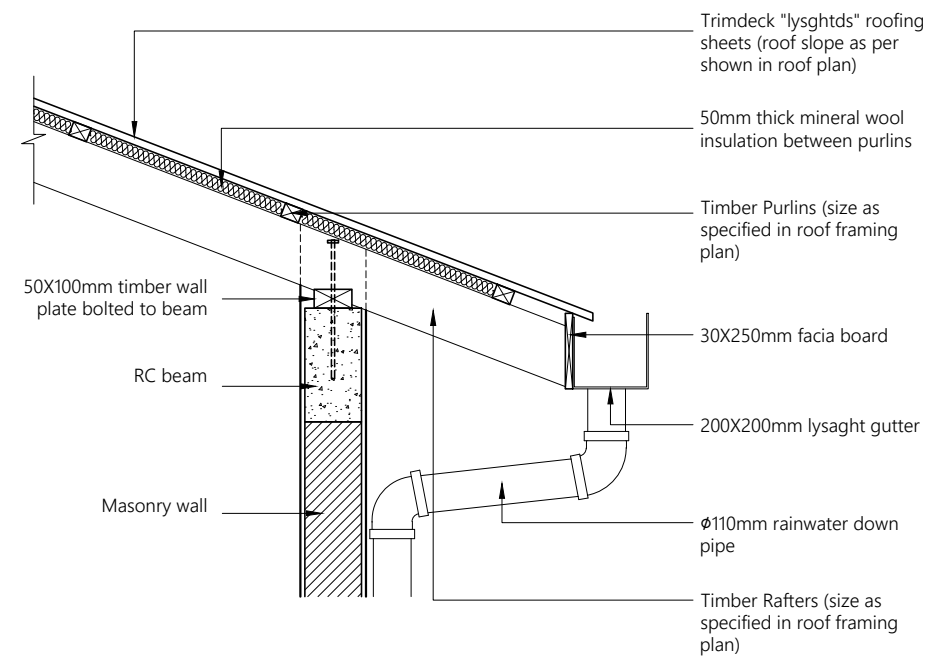
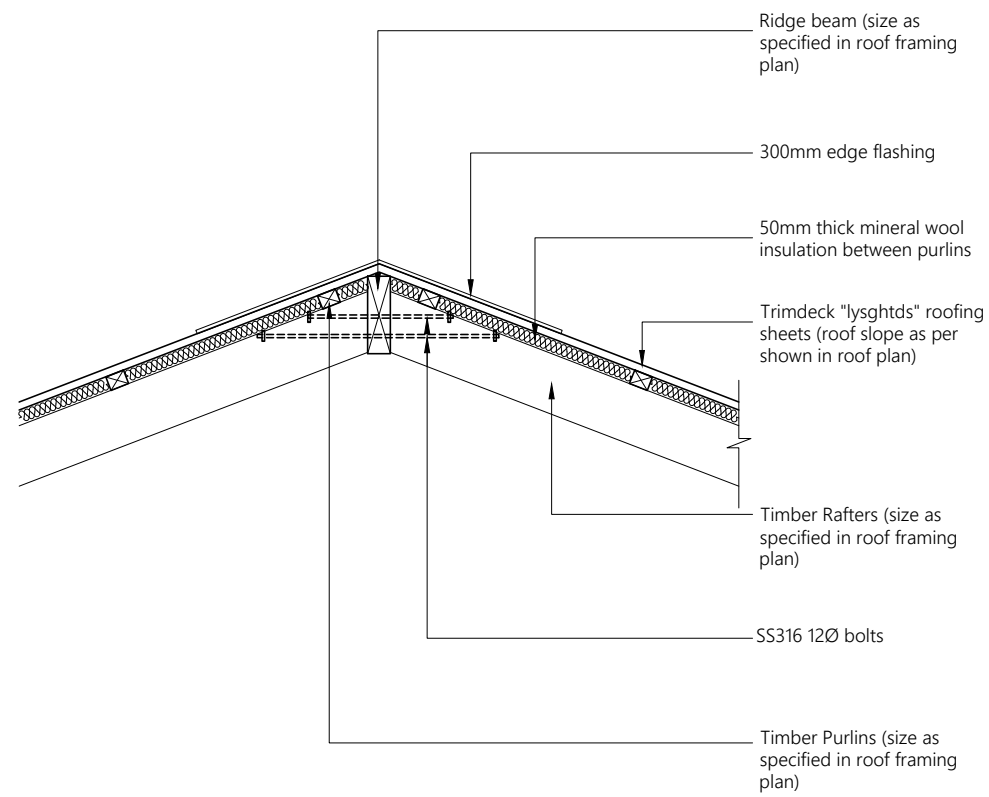

TYPICAL ROOF DETAIL

1:20

PROPOSED 01 STOREY BUILDING AT
SINGLE STOREY COUNCIL OFFICE

Sub Title:
COUNCIL PSI PROJECT

Client:
LOCAL GOVERNMENT AUTHORITY

December 2019

Architect: Mohamed Hassaan
Engineer: Ihsaan Waheed
Drawn By: Hussain Maathin



T: +960 333 3528 E: info@epoch.associates
W: www.epoch.associates A: M. Ahnagadhohuge,
Fareedhee Magu Male' Republic of Maldives

Rev:	Page:
---	-----
---	-----
---	-----
	A09

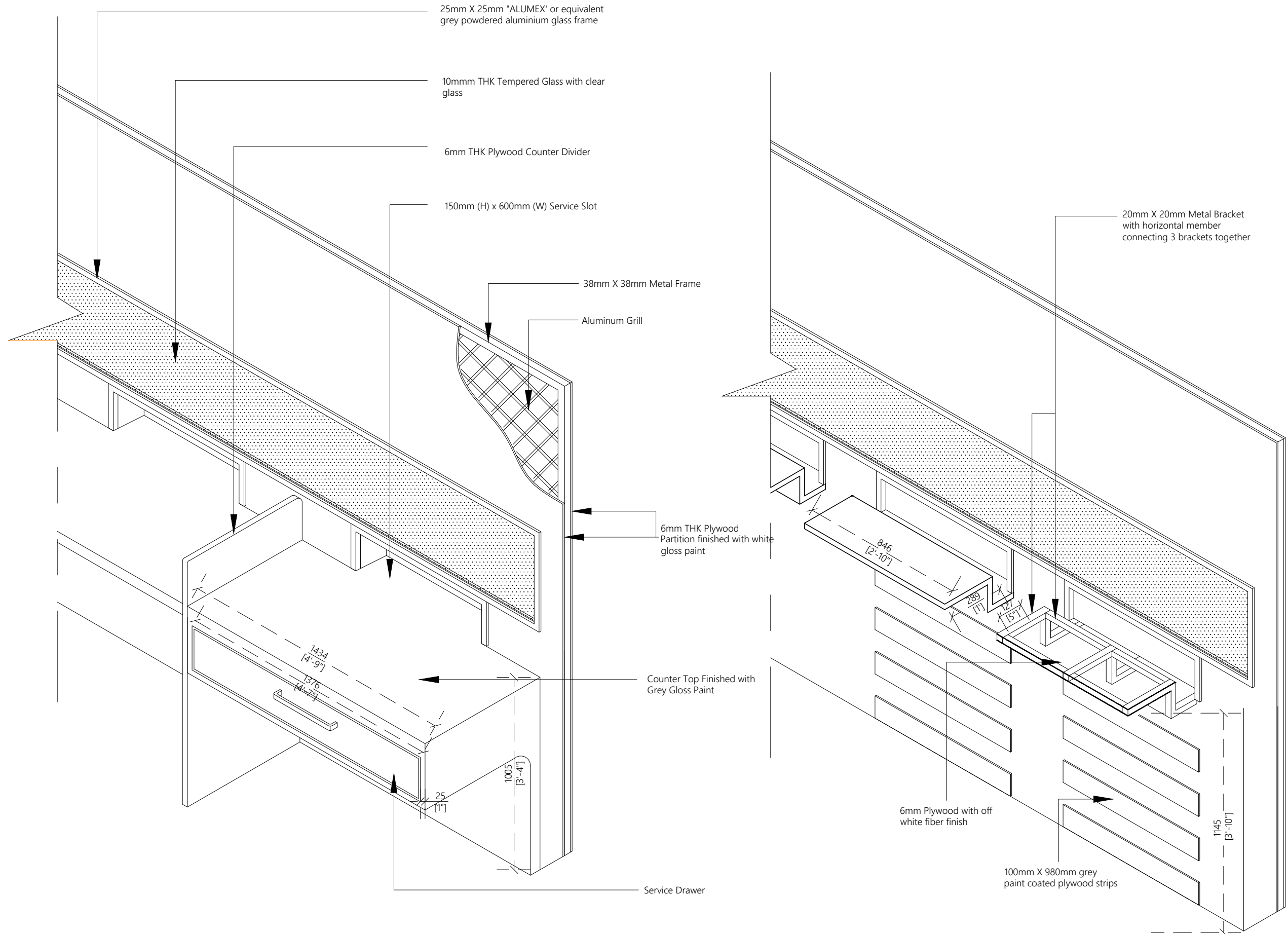

PROPOSED 01 STOREY BUILDING AT
SINGLE STOREY COUNCIL OFFICE

Sub Title:
COUNCIL PSI PROJECT

Client:
LOCAL GOVERNMENT AUTHORITY

December 2019

Architect: Mohamed Hassaan
 Engineer: Ihsaan Waheed
 Drawn By: Hussain Maathin

EPOCH ASSOCIATES

T: +960 333 3528 E: info@epoch.associates
 W: www.epoch.associates A: M. Ahsanulhasnuge, Faneetha Magu Male' Republic of Maldives

Rev: Page:
 A10

COUNTER DETAIL

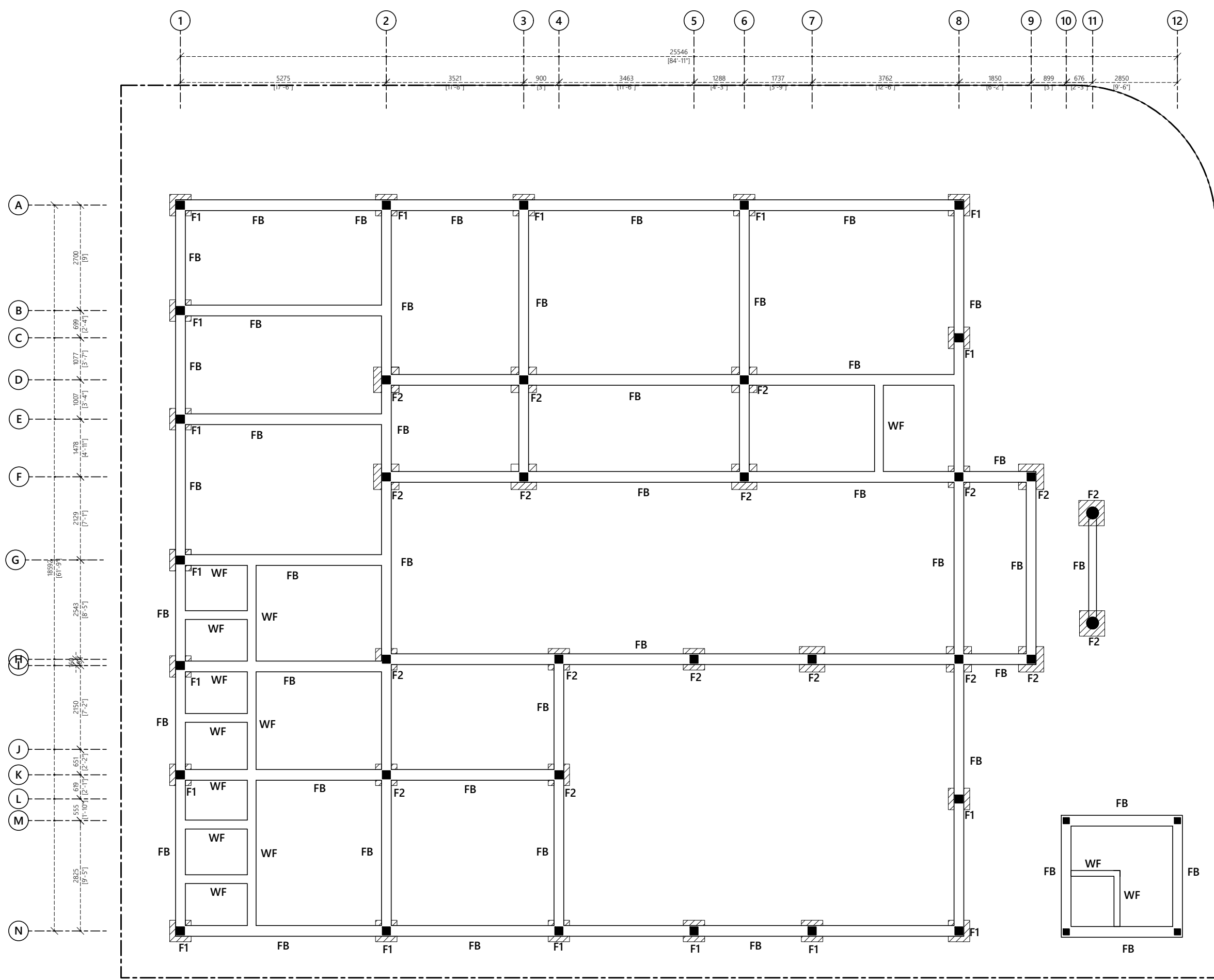

Notes:
 Foundation Depth: 800mm
 F1 - 550 x 550 x 150 - T10@200C/B/W (B)
 F2 - 650 x 650 x 150 - T10@ 200C/C B/W (B)

FOUNDATION PLAN

1:100

PROPOSED 01 STOREY BUILDING AT
SINGLE STOREY COUNCIL OFFICE

Sub Title:
COUNCIL PSI PROJECT
 Client:
LOCAL GOVERNMENT AUTHORITY

December 2019

Architect: Mohamed Hassaan
 Engineer: Ihsaan Waheed
 Drawn By: Hussain Maathin



T: +960 333 3528 E: info@epoch.associates
 W: www.epoch.associates A: M. Ahnagadhohuge, Faneedhee Magu Male' Republic of Maldives

Rev: Page:
 A12

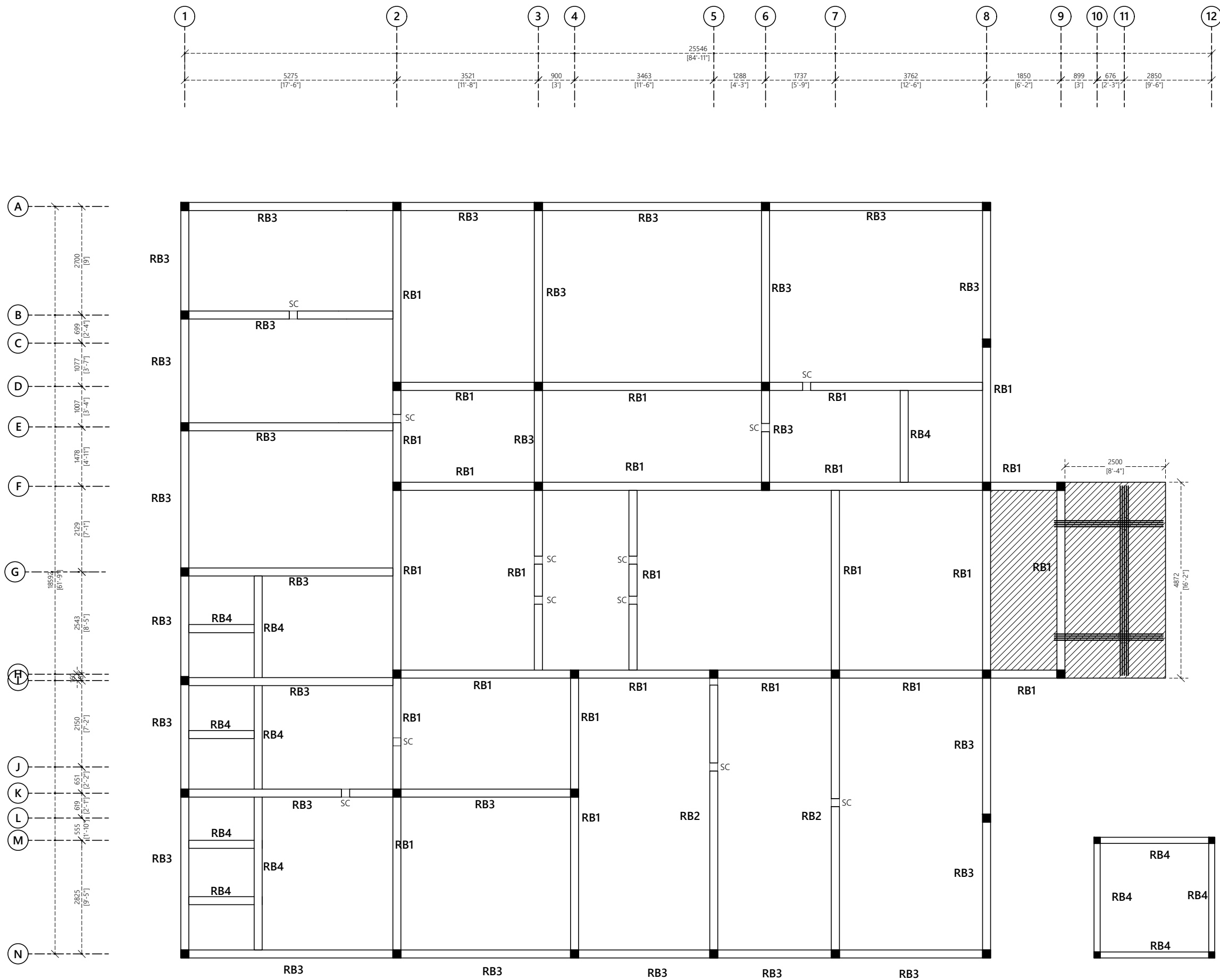

Notes:

- Slab Thickness: 130mm C/C
Top & Bottom Reinforcement: T10@120 C/C
- SC (Stiffener Column Planted from Roof Beam)

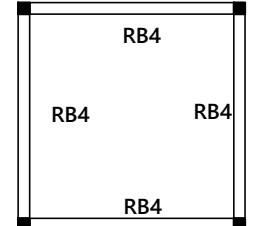

ROOF BEAM PLAN

1:100

PROPOSED 01 STOREY BUILDING AT
SINGLE STOREY COUNCIL OFFICE

Sub Title:
COUNCIL PSI PROJECT

Client:
LOCAL GOVERNMENT
AUTHORITY

December 2019

Architect: Mohamed Hassaan
Engineer: Ihsaan Waheed
Drawn By: Hussain Maathin

EPOCH ASSOCIATES

T: +960 333 3528 E: info@epoch.associates
W: www.epoch.associates A: M. Ahnagashohuge,
Fareedhee Magu Male' Republic of Maldives

Rev: Page:
..... **A13**
.....

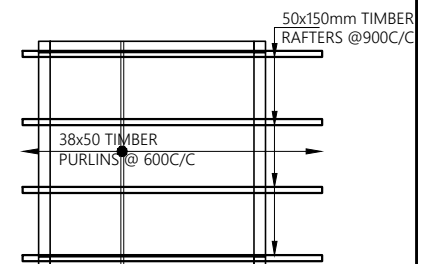
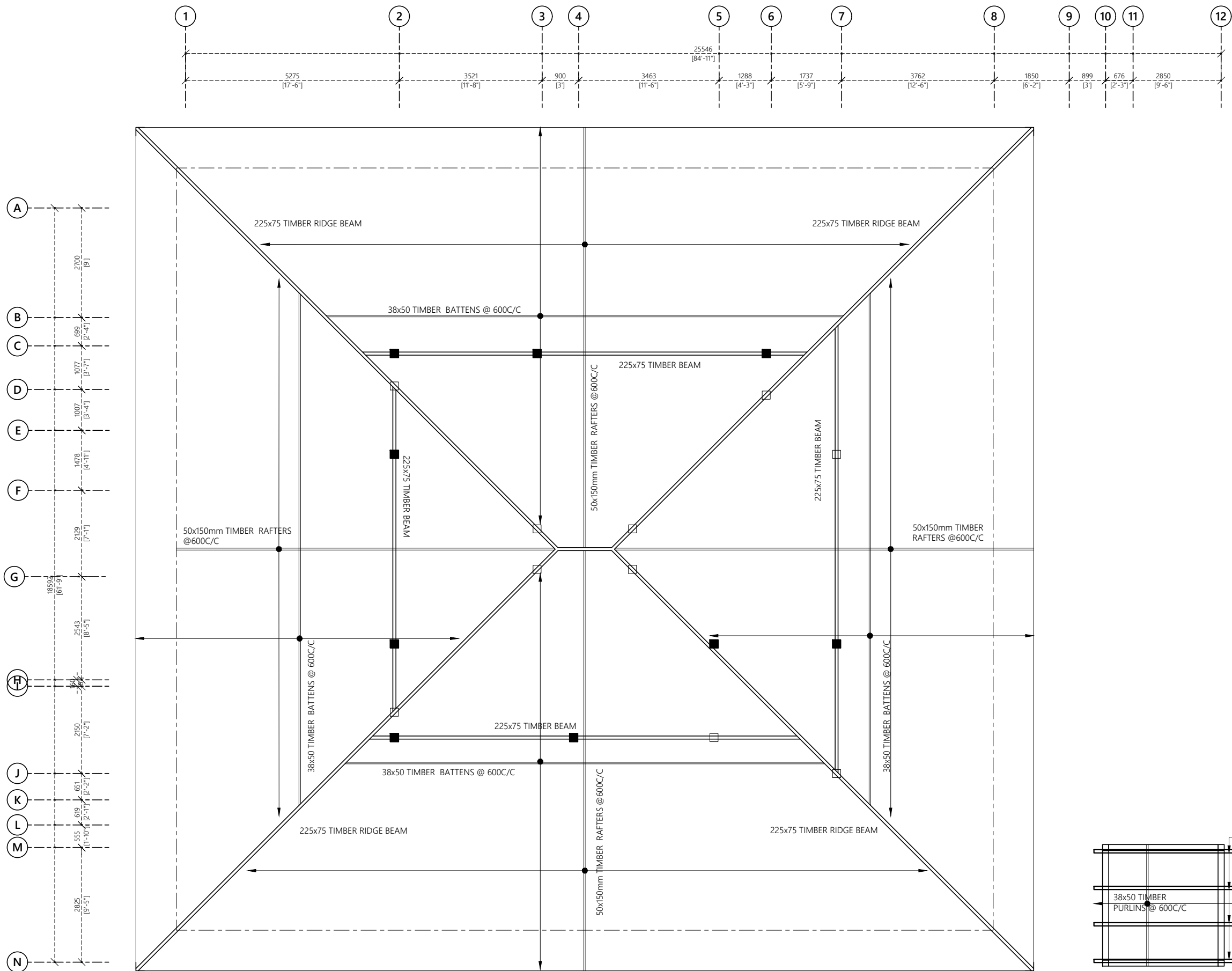

- Notes:**
- 75 X 100 TIMBER WALL PLATE
 - 150 X 50 TIMBER RAFTERS@600C/C
 - 38 X 50 TIMBER PURLINS@600C/C
 - 225X75 TIMBER RIDGE BEAM
 - 250x30 TIMBER FACIA
 - COLUMNS EXTENDED TO SUPPORT TIMBER BEAM
 - SC (STIFFNER COLUMN PLANTED FROM ROOF BEAM)

ROOF FRAMING PLAN

PROPOSED 01 STOREY BUILDING AT
SINGLE STOREY COUNCIL OFFICE

Sub Title:
COUNCIL PSI PROJECT

Client:
LOCAL GOVERNMENT AUTHORITY

December 2019

Architect: Mohamed Hassaan
Engineer: Ihsaan Waheed
Drawn By: Hussain Maathin



T: +960 333 3528 E: info@epoch.associates
W: www.epoch.associates A: M. Alhagashohuge, Faneedhee Magu Male' Republic of Maldives

Rev: Page:
..... **A14**

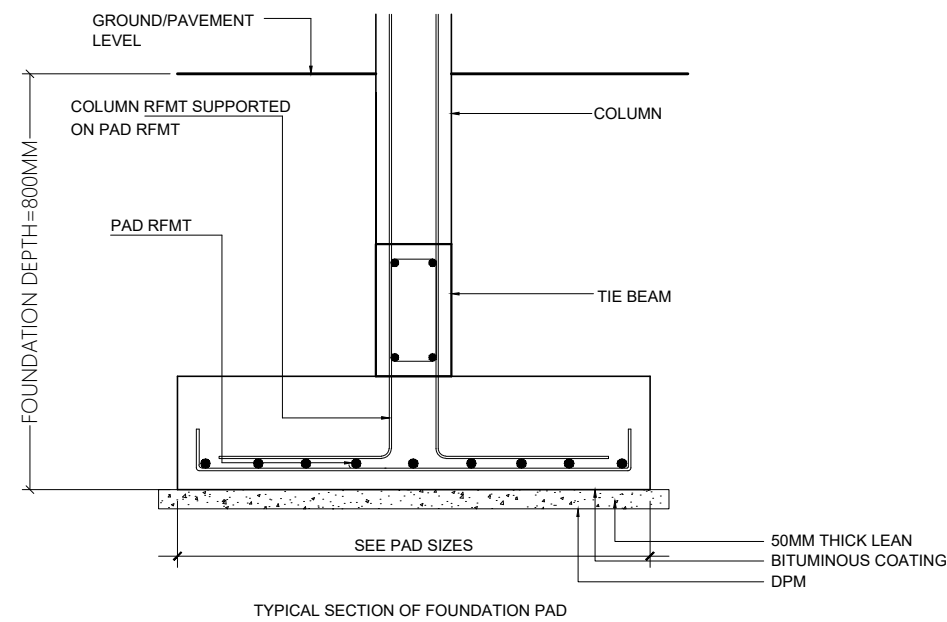
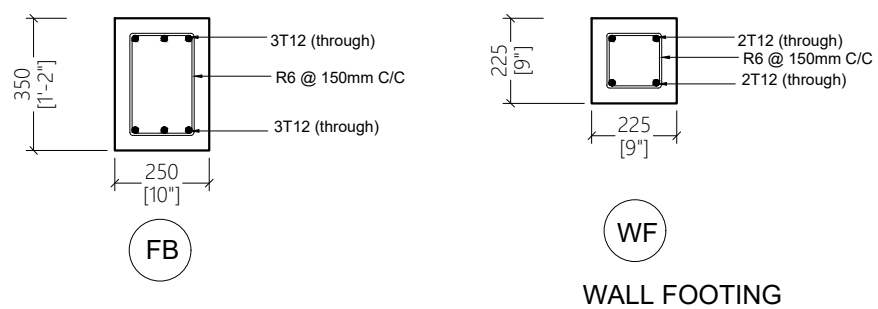
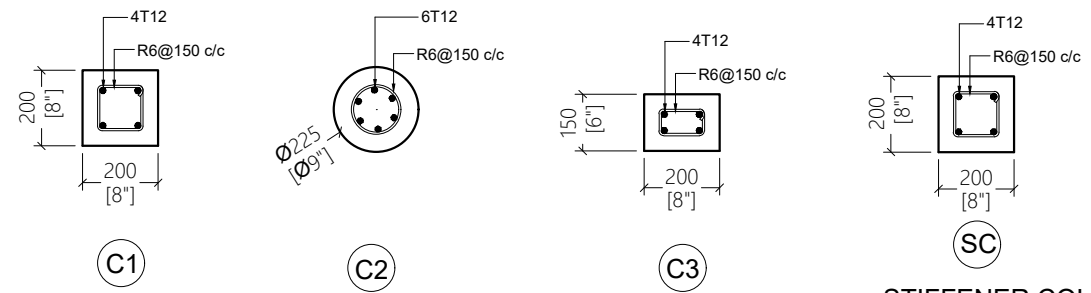
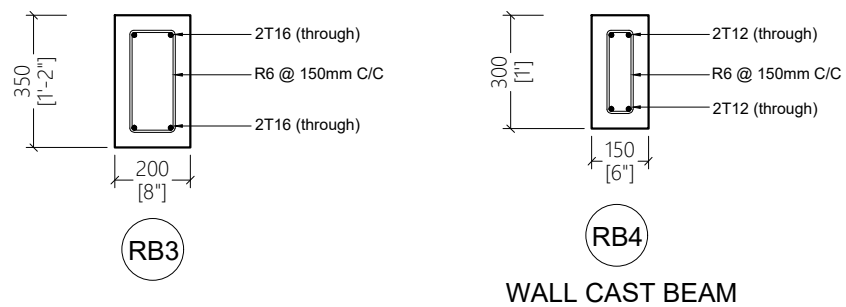
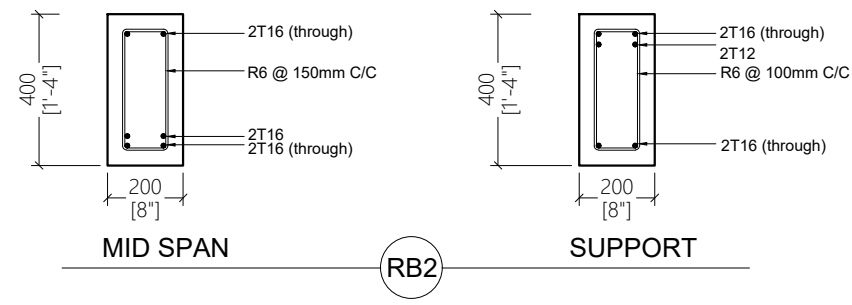
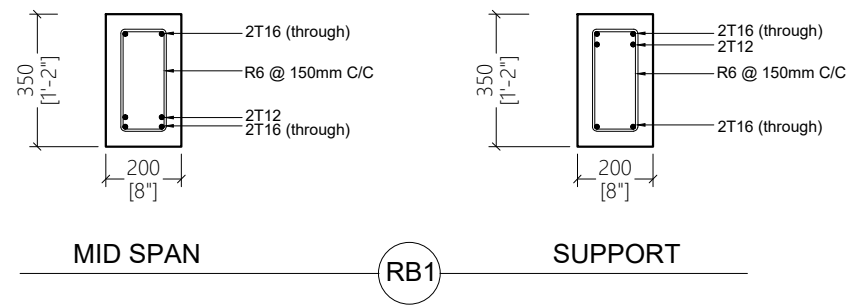

PROPOSED 01 STOREY BUILDING AT
SINGLE STOREY COUNCIL OFFICE

Sub Title:
COUNCIL PSI PROJECT
Client:
LOCAL GOVERNMENT AUTHORITY

December 2019
Architect: Mohamed Hassaan
Engineer: Ihsaan Waheed
Drawn By: Hussain Maathin



Rev: Page:
..... A15

STRUCTURAL DETAILS

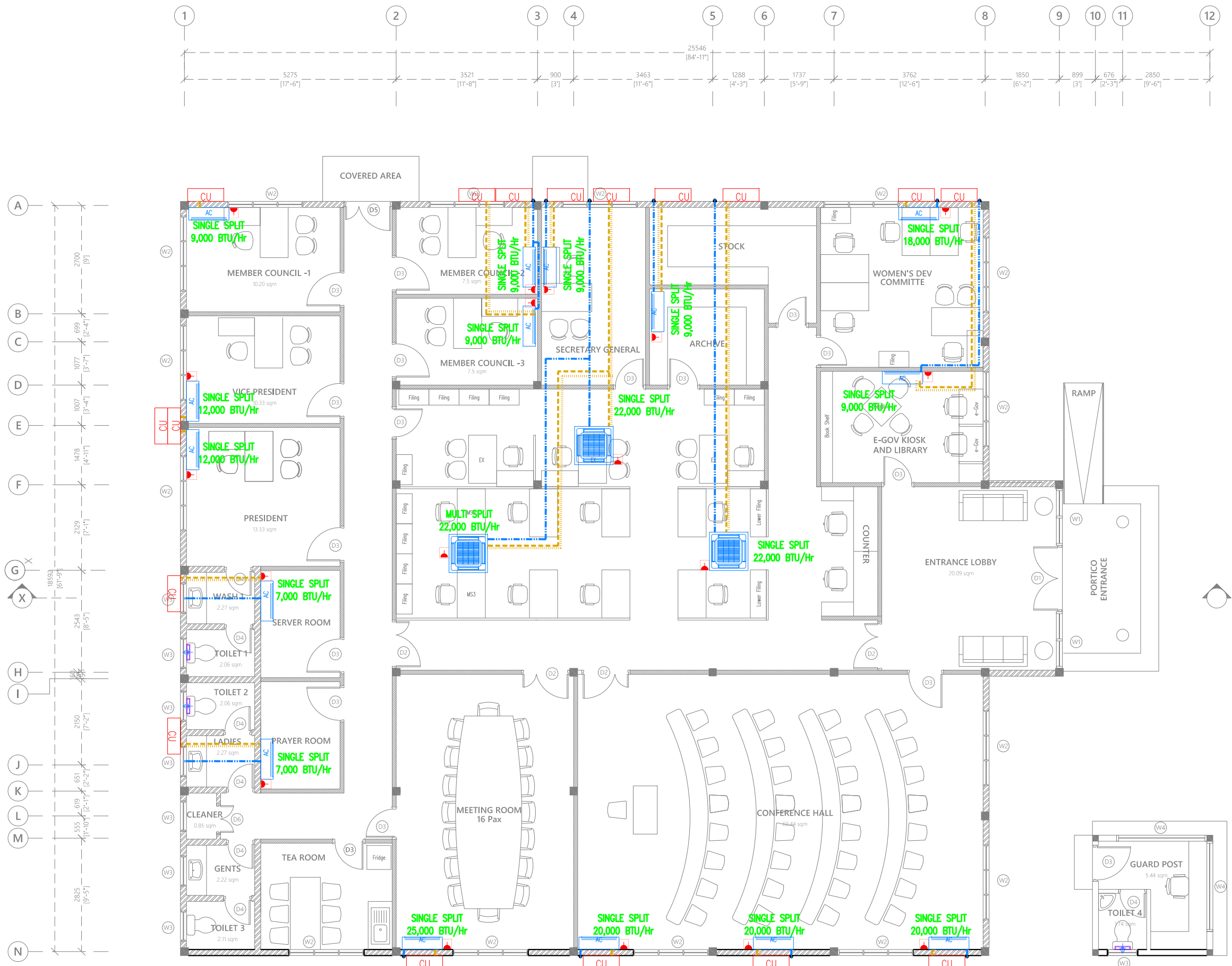

- Legend**
- Refrigerant Pipes
 - 25Ø Condensate Drain Pipe
 - 40Ø Condensate Drain Riser Pipe
 - Wall Mounted Exhaust Fan
 - Wall Mount Air Conditioner
 - 4-Way Cassette Air Conditioner
 - Outdoor Condensing Unit
 - 15A Switched Socket @ H.L.

Notes: -

Where Condensate Drain Pipes Are Connected To Wash Basin Or Kitchen Sink, 25 Ø Condensate Drain Pipe Is Extended In 32 Ø Flex Conduit Into 40 Ø Waste Pipe Of Respective Basin Or Sink

Proposed Single Storey Building at Council Building
Client: Local Government Authority (LGA)

Rev no	Date	General Notes:
1	18 June 2023	
2		
3		

Project Number: A/2023/038
 Date: 18 June 2023
 Architect: ABDUL WAHID MOHAMED
 Engineer: ISMAIL RAFFEU
 Services: NASHEED
 Interior: -



ARCON PRIVATE LIMITED
 t: +9603320203 m: +9607790203
 e: info@arcon.com.mv
 w: www.arcon.com.mv
 Ground floor, M. Salar Highway,
 Sabudheli Magu, Male'

Title:
 ACV LAYOUT

Page: SV - 01/07

GROUND FLOOR ACV LAYOUT

The contents of these drawings remain as a property of Arcon Private Limited. Any use other than those expressly stated is a violation of this copyright.

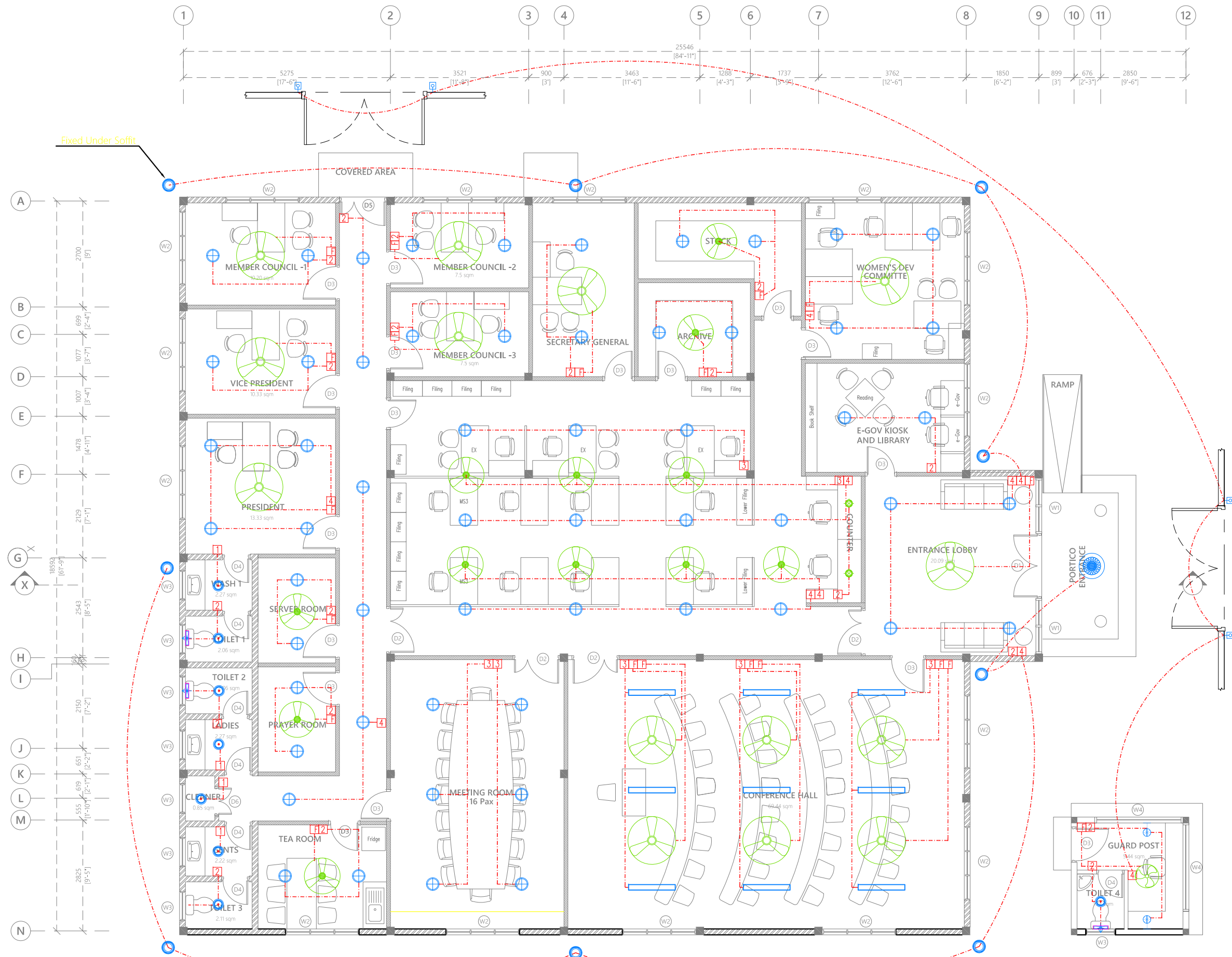

Legend

- Ceiling Light (12W)
- Recessed Ceiling Light (12W)
- Ceiling Down Light (18W) - Weather Proof
- 150 X 1200 Ceiling Recessed LED Panel
- Indoor Wall Light (18W)
- Outdoor Lamp (12W)
- Decorative Pendant Light
- Ceiling Mount Spot Light (5W)
- Light Switch (1 Gang - 4 Gang)
- Ceiling Fan Switch With Controller
- 29" To 36" Ceiling Fan
- 42" To 48" Ceiling Fan
- Wall Mounted Exhaust Fan
- Oscillating Ceiling Fan

Note: Distance to Gate and Guard Post to be determined based on measurements shown on Site Plan.

Proposed Single Storey Building at Council Building
Client: Local Government Authority (LGA)

Project Number: A/2023/038
 Date: 18 June 2023
 Architect: ABDUL WAHID MOHAMED
 Engineer: ISMAIL RAFFEU
 Services: NASHIED
 Interior: -

General Notes:
 Rev no : : : :
 Date : : : :
 : : : :
 : : : :

arcon

ARCON PRIVATE LIMITED
 t: +9603320203 m: +9607790203
 e: info@arcon.com.mv
 w: www.arcon.com.mv
 Ground floor, M. Salar Highway,
 Sabudheli Magu, Male'

Title:
 LIGHTING LAYOUT

Page: SV - 02/07

The contents of these drawings remain as a property of Arcon Private Limited. Any use other than those expressly stated is a violation of this copyright.

GROUND FLOOR LIGHTING LAYOUT



- Legend**
- 13A Twin Socket
 - 13A Twin Socket With USB Ports
 - 13A Power Socket
 - 15A Switched Socket @ H.L.
 - 15A Socket In Polycarbonate Box
 - Distribution Board
 - High Level
 - Angular Camera
 - Security Monitor
 - Digital/network Video Recorder
 - Telephone Outlet
 - Telephone Extension
 - Computer Network Outlet
 - Emergency Light
 - Wall Mounted Speaker
 - VGA Inlet Socket for Ceiling Mounted Projector
 - VGA Outlet Socket for Ceiling Mounted Projector
 - Electricity Meter
 - Internet Switchboard
 - Private Automatic Branch Exchange (PABX)
 - PVC Duct For Tel./Internet Cable Lead In Below Ground Slab
 - PVC Duct For TV Cable Lead In Below Ground Slab
 - Main Incoming Cable For Power PVC Duct Below Ground

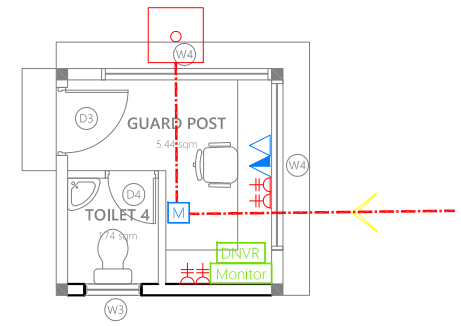

Proposed Single Storey Building at Council Building
Client: Local Government Authority (LGA)
 Project Number: A/2023/038
 Date: 18 June 2023
 Architect: ABDUL WAHID MOHAMED
 Engineer: ISMAIL RAFFEU
 Drawn by: ISMAIL RAFFEU
 Services: NASHIED
 Interior: -

Rev no	Date	General Notes:
-	-	-
-	-	-
-	-	-

ARCON PRIVATE LIMITED
 t: +9603320203 m: +9607790203
 e: info@arcon.com.mv
 w: www.arcon.com.mv
 Ground floor, M. Salar Highway,
 Sabudheli Magu, Male'

Title:
 POWER LAYOUT
Page: SV - 03/07

GROUND FLOOR POWER LAYOUT

The contents of these drawings remain as a property of Arcon Private Limited. Any use other than those expressly stated is a violation of this copyright.

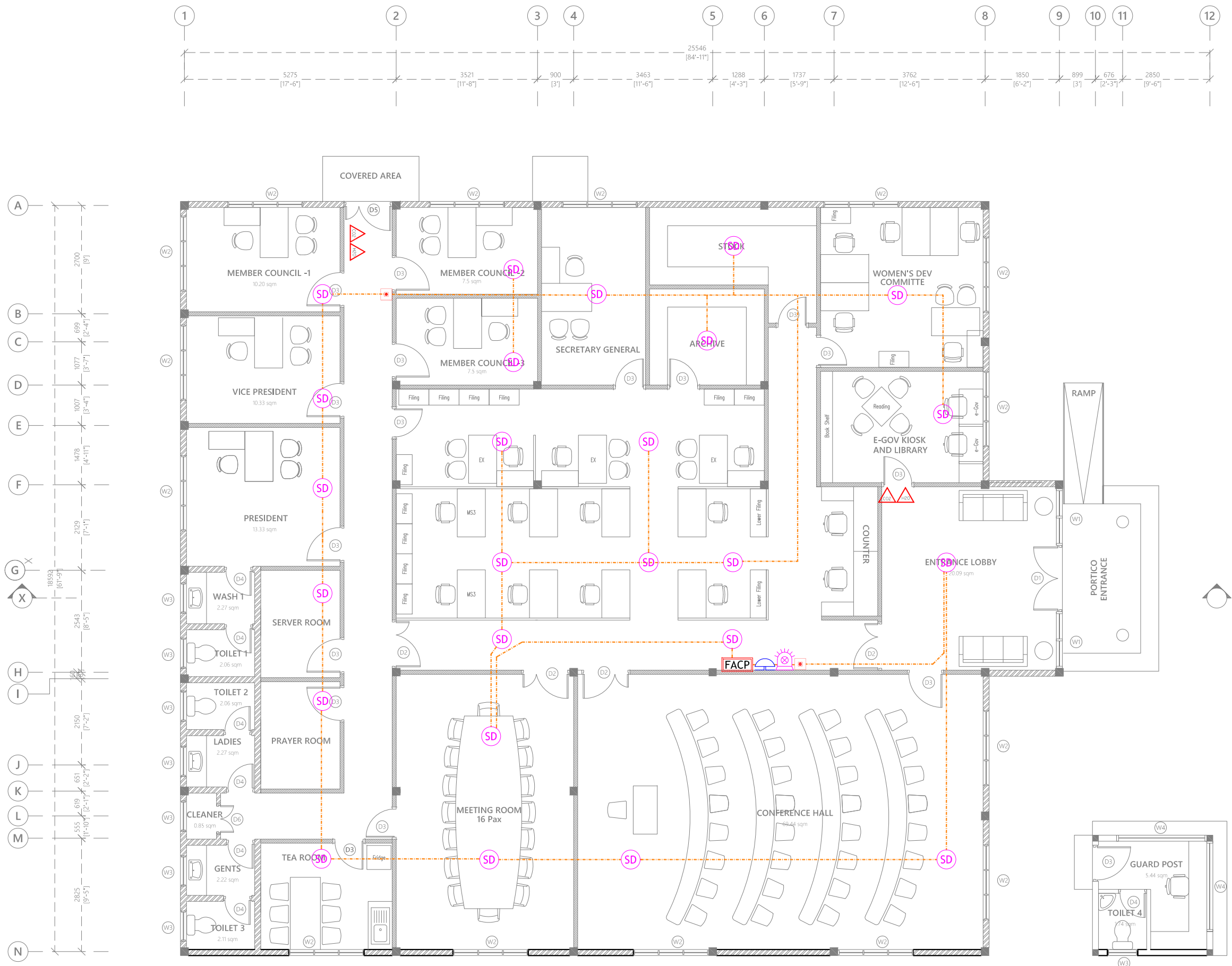

- Legend**
- CO2 Extinguisher (load: 2kg) In Polycarbonate Enclosure
 - H2O Extinguisher (load: 9L) In Polycarbonate Enclosure
 - Manual Call Point
 - Smoke Detector
 - Beacon
 - Sounder Bell
 - 2.5mm² Fire Retardant Low Smoke (FRLS) Cables In FRLS Conduits
 - FACP Fire Alarm Control Panel

1. ALL DRY RISER PIPES SHOULD BE GALVANIZED, SCHEDULE 40.
2. ALL DRY RISER PIPES SHALL BE PAINTED IN RED AS PER REGULATION.
3. ALL SUPPORT/BACKET SHALL BE HOT DIPPED GALVANIZED.

Proposed Single Storey Building at Council Building
Client: Local Government Authority (LGA)
 Project Number: A/2023/038
 Date: 18 June 2023
 Architect: ABDUL WAHID MOHAMED
 Engineer: ISMAIL RAFFEU
 Drawn by: NASHIED
 Services: NASHIED
 Interior: -

Rev no	Date	General Notes:

ARCON PRIVATE LIMITED
 t: +9603320203 m: +9607790203
 e: info@arcon.com.mv
 w: www.arcon.com.mv
 Ground floor, M. Salar Highway,
 Sabudheli Magu, Male'

















Title:
FDP LAYOUT

Page: SV - 04/07

The contents of these drawings remain as a property of Arcon Private Limited. Any use other than those expressly stated is a violation of this copyright.

GROUND FLOOR FDP LAYOUT

Legend

-  16Ø Cold Water Supply To Basin Faucet
-  16Ø Cold Water Supply To Sink Tap
-  16Ø Cold Water Supply To Bidet Shower
-  16Ø Cold Water Supply To Cistern
-  Gate Valve
-  Rise In Wall
-  Drop In Wall
-  MWSC/FENAKA Meter
-  20Ø Cold Water Supply Pipes Running Underground
-  20Ø Cold Water Supply Pipes Running In Wall
-  20Ø Cold Water Supply Pipes Running Underground
-  20Ø Ground Water Supply (GWS) Pipe
-  Foot Valve With Strainer
-  Well Water Pump
-  16Ø Ground Water Supply To Sink Tap
-  16Ø Ground Water Supply To Cistern



GROUND FLOOR PLUMBING LAYOUT

Proposed Single Storey Building at Council Building
Client: Local Government Authority (LGA)
 Project Number: A/2023/038
 Date: 18 June 2023
 Architect: ABDUL WAHID MOHAMED
 Engineer: ISMAIL RAFFEU
 Drawn by: NASHIED
 Interior: -

Rev no	Date	General Notes:
-	-	-
-	-	-
-	-	-



ARCON PRIVATE LIMITED
 t: +9603320203 m: +9607790203
 e: info@arcon.com.mv
 w: www.arcon.com.mv
 Ground floor, M. Salar Highway,
 Sabudhelli Magu, Male'

Title:
 PLUMBING LAYOUT

Page: SV - 05/07

PL-01

The contents of these drawings remain as a property of Arcon Private Limited. Any use other than those expressly stated is a violation of this copyright.

Note:
Septic Tank will not be required if the island has a sewer system installed.



Legend

- Floor Drain
- Floor Gully
- 400 Stub For Washing Machine Or Tub
- 820 Soil Pipe (uPVC Pipe)
- 820 Soil Vent Pipe (uPVC Pipe)
- 630 Waste Pipe (uPVC Pipe)
- 630 Waste Vent Pipe (uPVC Pipe)
- 400 Waste Pipe (uPVC Pipe)
- 500 Manhole Vent Pipe (uPVC Pipe)
- 110 Rain Water Pipes (uPVC Pipe)
- Gully Trap
- 1100 Rainwater Outlet
- Clean Out Point
- Bottle Trap

Notes: -

- All Drainage Pipes Should Have At A Slope Of 1/150
- All Floor Drains Should Have 'P' Traps

Proposed Single Storey Building at Council Building
Client: Local Government Authority (LGA)

Project Number: A/2023/038
Date: 18 June 2023
Architect: ABDUL WAHID MOHAMED
Engineer: ISMAIL RAFFEU
Services: NASHIED
Interior: -

Rev no	Date	General Notes:
-	-	-
-	-	-
-	-	-



ARCON PRIVATE LIMITED
t: +9603320203 m: +9607790203
e: info@arcon.com.mv
w: www.arcon.com.mv
Ground floor, M. Salar Highway,
Sabudhelli Magu, Male'

Title:
DRAINAGE LAYOUT

Page: SV - 06/07

The contents of these drawings remain as a property of Arcon Private Limited. Any use other than those expressly stated is a violation of this copyright.

DR-01

GROUND FLOOR DRAINAGE LAYOUT

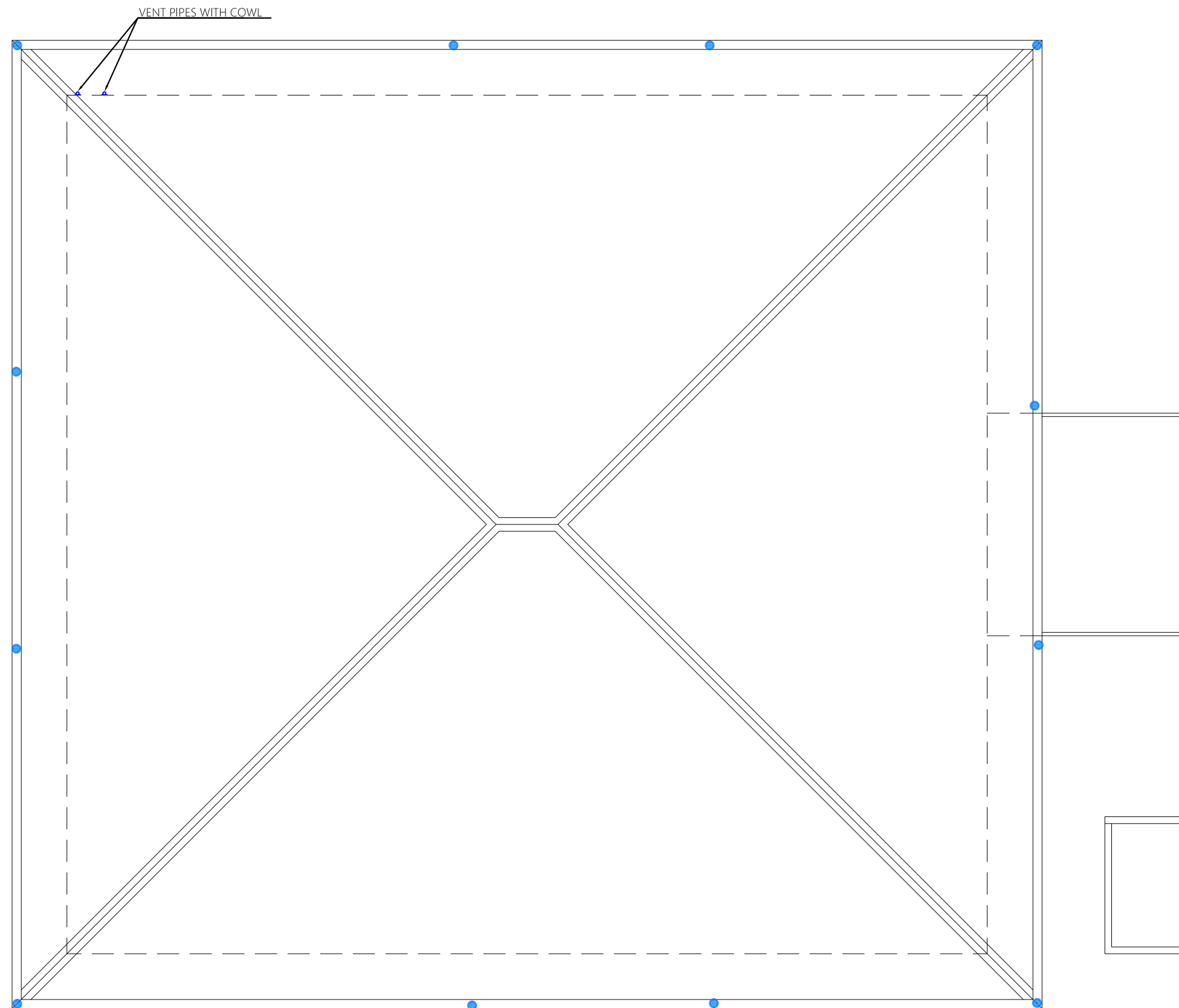

- Legend**
- Floor Drain
 - Floor Gully
 - 40Ø Stub For Washing Machine Or Tub
 - 82Ø Soil Pipe (uPVC Pipe)
 - 82Ø Soil Vent Pipe (uPVC Pipe)
 - 63Ø Waste Pipe (uPVC Pipe)
 - 63Ø Waste Vent Pipe (uPVC Pipe)
 - 40Ø Waste Pipe (uPVC Pipe)
 - 50Ø Manhole Vent Pipe (uPVC Pipe)
 - 110mm Rain Water Pipes (uPVC Pipe)
 - Gully Trap
 - 110Ø Rainwater Outlet
 - Clean Out Point
 - Bottle Trap

Notes: -
 -All Drainage Pipes Should Have At A Slope Of 1/150
 -All Floor Drains Should Have 'P' Traps

Proposed Single Storey Building at Council Building
Client: Local Government Authority (LGA)

Project Number: A/2023/038	Date: 18 June 2023	Rev no	Date	General Notes:
Architect: ABDUL WAHID MOHAMED	Engineer: ISMAIL RAFFEU	-	-	-
Drawn by: NASHIED	Interior: -	-	-	-

ARCON PRIVATE LIMITED
 t: +9603320203 m: +9607790203
 e: info@arcon.com.mv
 w: www.arcon.com.mv
 Ground floor, M. Salar Highway,
 Sabudheli Magu, Male'

Title: ROOF DRAINAGE LAYOUT

Page: SV - 07/07

The contents of these drawings remain as a property of Arcon Private Limited. Any use other than those expressly stated is a violation of this copyright.

ROOF DRAINAGE LAYOUT

1:100

DR-02

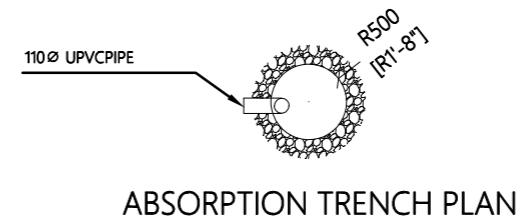
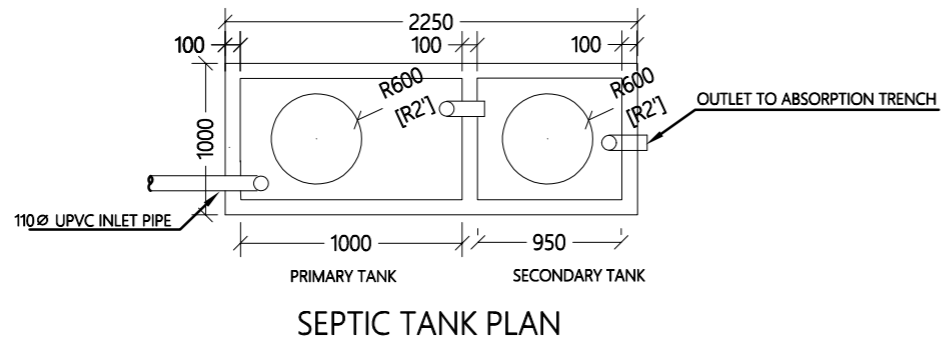
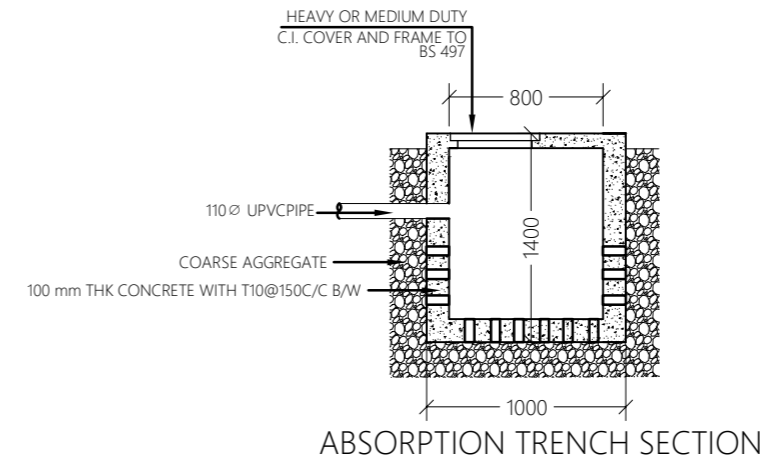
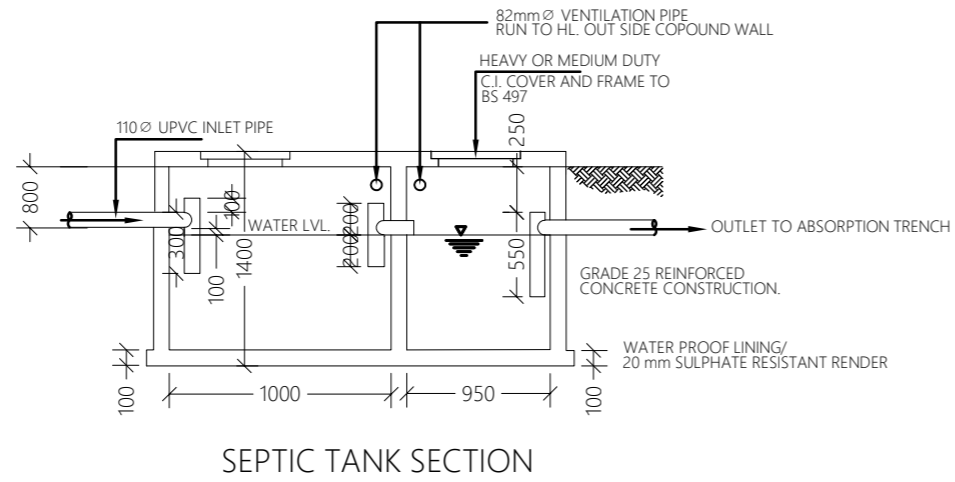

PROPOSED 01 STOREY BUILDING AT
**SINGLE STOREY
COUNCIL OFFICE**

Sub Title:
COUNCIL PSI PROJECT

Client:
**LOCAL GOVERNMENT
AUTHORITY**

July 2019

Services By: Mohamed Rassam
Checked By:
Drawn By: Hussain Rasheed



T: +960 333 3528 E: info@epochassociates
W: www.epochassociates.com M: M. Afiyas@hoshuge
Faraidhee Magu Male' Republic of Maldives

Rev: Page:
.....
..... **DR-03**
.....

SEPTIC TANK DETAIL

1:100