



Maldives Atoll Education Development Project (AEDP)

Ministry of Education
Republic of Maldives

Procurement of Tools Equipment for General Skills Lab

(Reference No: MV-MOE-371224-GO-RFQ)

Announcement No: **JS-A/2023/048**

Date: **24.07.2023**

INFORMATION FOR BIDDERS

The Ministry of Education now invites quotations from eligible bidders for the following item/s:

EVALUATION CRITERIA:

The evaluation criteria are as follows:

Details	Yes / No
Company/Sole Proprietorship Registration	Compulsory
MIRA Tax Registration – If Applicable, For locals only	Compulsory
Experience letter (Minimum 2): [Supplied items similar to requirement in past 3 years) Please submit the supporting document for the proof.	Compulsory
Technical Evaluation	Pass/Fail
Price (Please specify the offered items specifications in the quotation or please provide the offered item with specification)	100%

QUOTATION REQUIREMENTS:



- 1) Description of Supply and Delivery
Supply and delivery of Equipment for General skill lab to Jamaluddin School.
- 2) Quotation prices should be Delivery duty paid (**DDP**) to **location stated above**. Either price must include the cost of local insurance, transportation and delivery costs to **the above-mentioned final destination**. The total prices required are therefore total prices to the final destinations. Such prices are to include all local customs charges, import and sales taxes where appropriate.
- 3) The delivery period required is **15 days** from date of order.
- 4) Quotations must be valid for **30 days** from the date for receipt given below.
- 5) Quotations must be received, in sealed envelopes, no later than: 03.08.2023 / 13:00.
- 6) Quotations must be submitted to: **Jamaluddin School**
- 7) Please provide clear photos of the items to be offered.







Important Information to be noted:





- Please provide clear specifications in a separate quotation in accordance with the detailed specs (for easier reference).
- All prices are to be under the delivered duty paid (DDP) to final location.

TECHNICAL SPECIFICATION

Basic Wood work

#	Details	Type	Sample Photo	
1	Workbench, Solid and rigid, with a flat hardtop (3/4"), and deep enough (front to back).	1 pcs	6'11"x3'5"x2'6" or Equivalent	
2	Lumber plank, Softwood (Pine). 2" x 1" x 5'	5 pcs	2" x 1" x 5'	
3	Lumber plank, Softwood (Pine), 2" x 2" x 5'	5 pcs	2" x 2" x 5'	
4	Lumber plank, Softwood (Pine), 2" x 2" x 5'	5 pcs	2" x 2" x 5'	
5	Plywood (12mm), 4 x 4 ft	3 pcs	(12mm), 4 x 4 ft	
6	Plywood (6mm), 4 x 4 ft	3 pcs	(6mm), 4 x 4 ft	

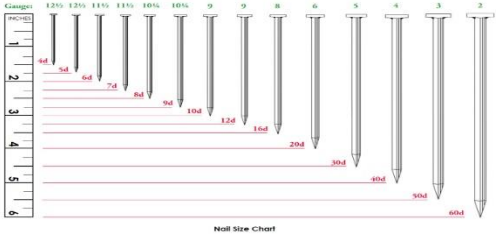
7	Pegboard (metal), 3 pieces in each set, 16 x 32 in (With Installation)		set	3 pieces in each set, 16 x 32 in	
8	Hand planer, 6-1/4-Inch (12-920)	3	pcs	6-1/4-Inch (12-920)	
9	Chisel set	3	set	Set	
10	Level (24")	3	pcs	24"	
11	Screwdriver set	2	Set	Set	
12	Tape measure, 3m - 10ft	3	pcs	3m - 10ft	
14	C-clamp (6"), 12" or 13"	3	pcs	(6"), 12" or 13"	

15	Claw hammer	4	pcs		
16	Hand saw (16")	2	pcs	(16")	
17	Nail (1")	3	box	(1")	 <p style="text-align: center;">Nail Size Chart</p>
18	Nail (2")	3	box	(2")	
19	Nail (3")	3	box	(3")	
20	Safety glasses - clear	10	pcs	Clear	
21	Sandpaper (No. 180)	3	roll	(No. 180)	
22	Sandpaper (No. 80)	3	roll	(No. 80)	
23	Square ruler - metal	3	pcs	metal	

24	Tapping screw (1 1/2"), GI / Steel, full thread, No. 8	3	box	(1 1/2"), GI / Steel, full thread, No. 8
25	Tapping screw (1"), GI / Steel, full thread, No. 8	2	box	(1"), GI / Steel, full thread, No. 8
26	Tapping screw (2"), GI / Steel, full thread, No. 8	2	box	(2"), GI / Steel, full thread, No. 8
27	Tapping screw (3"), GI / Steel, full thread, No. 8	2	box	(3"), GI / Steel, full thread, No. 8
28	Tapping screw (3/4"), GI / Steel, full thread, No. 8	2	box	(3/4"), GI / Steel, full thread, No. 8
29	Wood glue (Dunlop)	5	can	



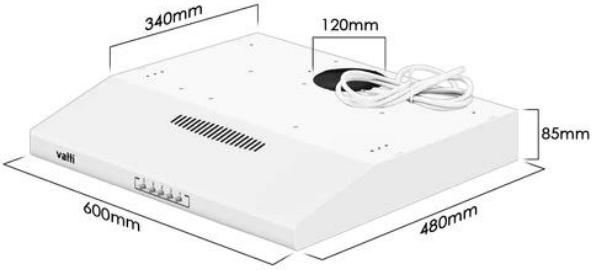

Cooking & Dinning

1	Cleaning sponge	10	pcs		
2	Dishwasher liquid	6	bottle		

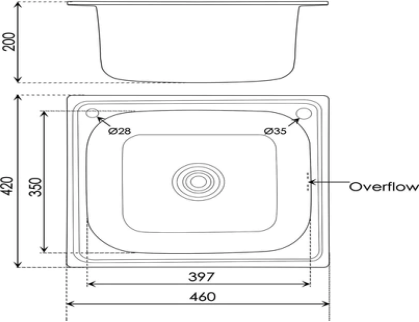
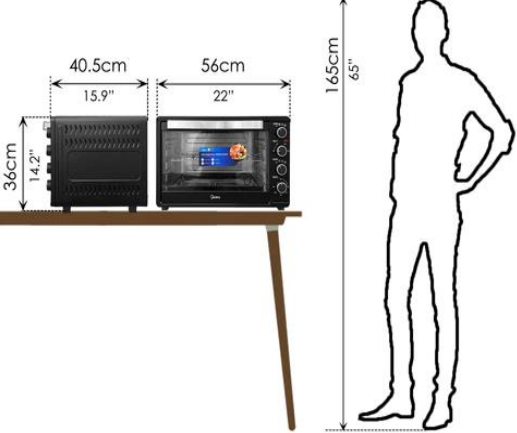
3	Handwashing liquid	6	bottle		
4	Kitchen cabinet set (6 Cabinet top with Hood /6 Cabinet bottom with 2 Kitchen sink with Tap & 2 Stove) 1 Full Cabinet with Microwave Oven and Normal Baking Oven) with installation work and Connection of water to 2 sinks) Please specify the measurements	1	set		
5	Kitchen Hood	2	Pcs		

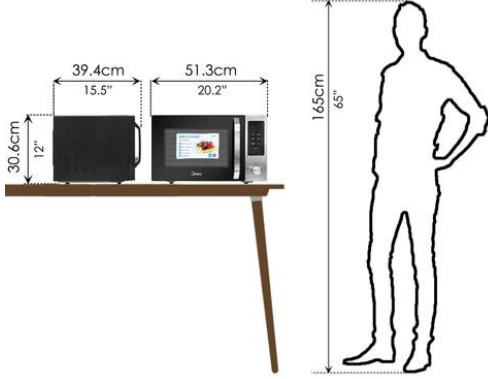

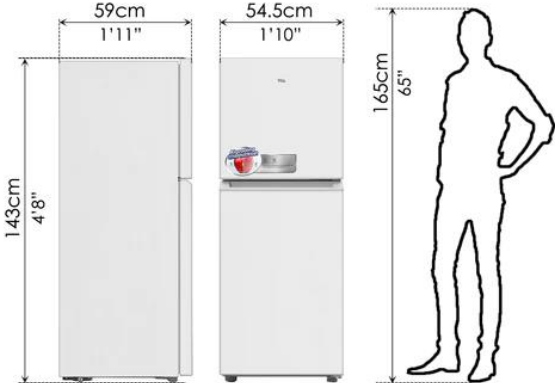

6	Sink tap, Material: Chrome Steel,	2	pcs		
7	Kitchen Sink, Sink Hole: 9cm, Material: Stainless Steel, Accessories: P-Trap Pipe (PVC) with Drain Kit – X1 Basket Strainer Drain – X1	2	Pcs		<p style="text-align: right;">Unit: mm</p> 
8	Baking Oven	1	Pcs	Oven Capacity: 55 Liter, Accessories: Crumb Tray (x1), Wire Rack (x1), Bake Tray (x1), Rotisserie Fork (x1), Rotisserie Handle (x1), & Tray Handle (x1).	



9	Microwave	1	Pcs	Oven Capacity: 28 L, Warranty: 12 Months Warranty	 <p>Diagram showing a microwave oven on a table. Dimensions: 39.4cm (15.5") width, 30.6cm (12") height, 51.3cm (20.2") depth. A human silhouette indicates a height of 165cm (65").</p>
10	Gas cooker (2 burner)	2	Pcs		 <p>Image of a black gas cooker with two burners.</p>
11	Fridge Minimum Specification, Total Storage Volume: 200 Liter, Storage Volume of Freezer: 58 Liter, Warranty: 12 Months Warranty,	1	Pcs	Product Dimension (W x D x H): Inch ("): 21.5" x 23.2" x 56.3"	 <p>Diagram showing a refrigerator. Dimensions: 59cm (1'11") width, 54.5cm (1'10") depth, 143cm (4'8") height. A human silhouette indicates a height of 165cm (65").</p>

12	Table cloth	3	Pcs		
13	Napkins	6	pcs		
14	LP Gas (10kg) with Installation (Please specify the measurements)	2	Pcs		
15	Cake tray	2	Set		

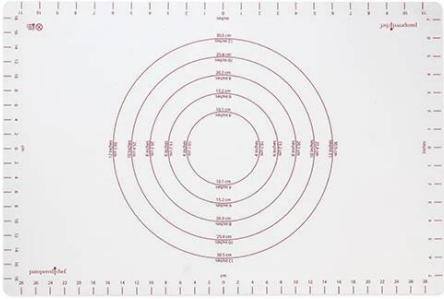
16	Cooking utensils set (5 Pcs)	2	set		
17	Cutlery	2	set		





18	Cutting board set	3	Pcs set		
19	Dinnerware set, Plain white, 16 pcs	1	set		
20	Kitchen knife set	2	Set		
21	Measuring cups	1	set		



22	Muffins tray	2	pcs		
23	Pastry brush	5	pcs		
24	Pastry mat (40-60 cm)	2	pcs		
25	Rolling pin	2	pcs		

26	Steel bowl set (9cm -12cm)	6	Pcs set		
27	Storage Plastic Container	3	pcs		
28	Dinning table	1	pcs		
29	Dining chairs	6			





Art & Craft

#	Details	Type		Sample Photo
1	Fishing line (10 lb)	3	Pcs	
2	Fishing line (35 lb)	3	Pcs	
3	Fishing line (5 lb)	3	Pcs	

4	Acrylic Paints kit (6 colors)	5	set	
7	Paintbrushes kit (8 pc)	5	Set	
9	Coir rope (roanu)	5	roll	
10	Origami paper set	10	set	
11	Fishing hooks (No. 2)	02	Box	
12	Fishing hooks (No. 3)	02	Box	

13	Fishing hooks (No. 4)	02	Box	
14	Locker Steel, 9 Compartment	2	Pcs	
16	Stool, Adjustable, Durable, Hight 73 - 94 cm, Base, 38 - 45 cm,	24	Pcs	

Machine Sewing

#	Details		Type	Sample Photo
1	Cotton Fabric cloth (white/normal)	2	roll	
2	Tailor's chalk	10	pcs	
3	Tailor's scissors	8	pcs	
4	Sewing pins set	5	set	

5	Soft tape measure (10ft)	8	pcs	
6	Needlework kit	10	set	
7	Sewing machine, Auto threading system, Top load bobbin, Auto set stitch length (max. 4mm) and width (max. 5mm), 4-step buttonhole, Free arm, Twin needle sewing, 14 built-in stitches, LED lighting for easy viewing	5	pcs	
8	Sewing thread set	5	set	
9	Machine needles set (Different Size)	5	set	
10	Seam ripper set	8	set	