

Column and Tie beam plan

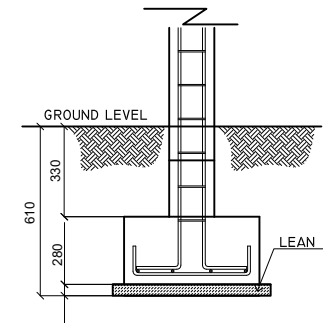

Kulhudhuffushi Regional Hospital

Roofing

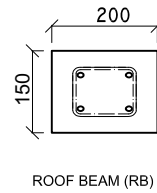
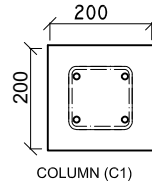
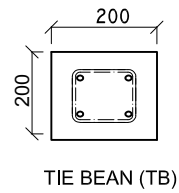
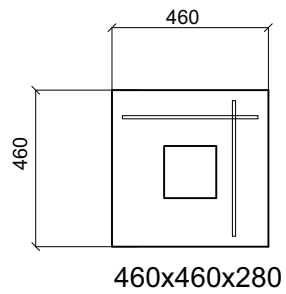
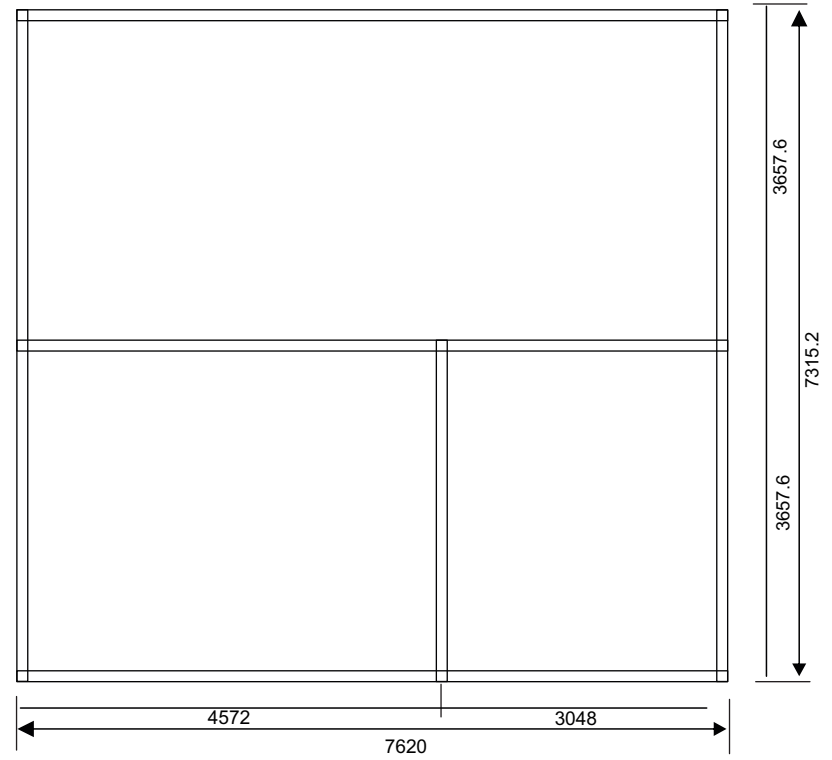
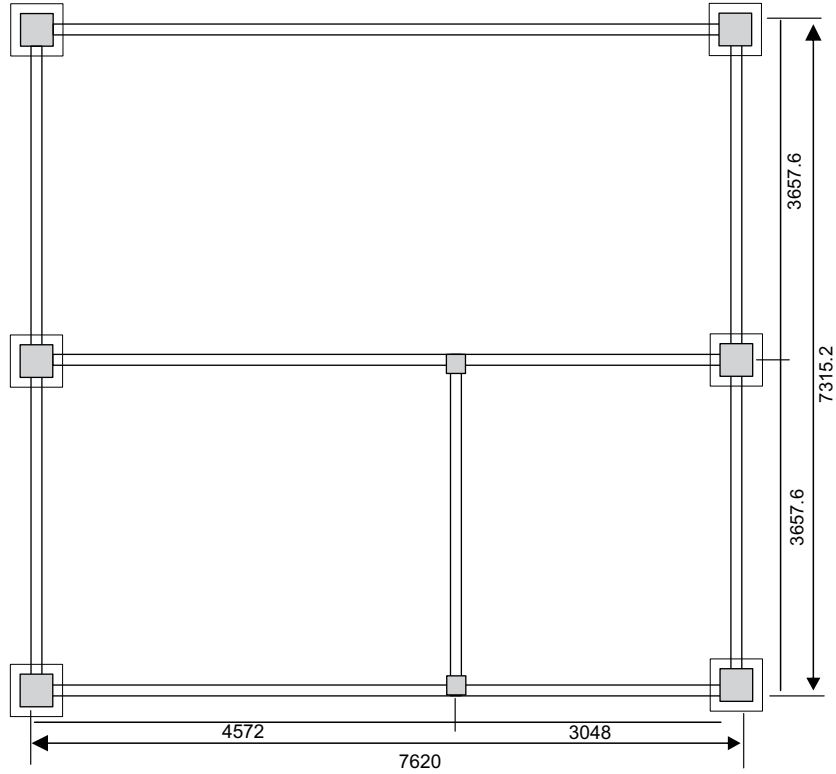
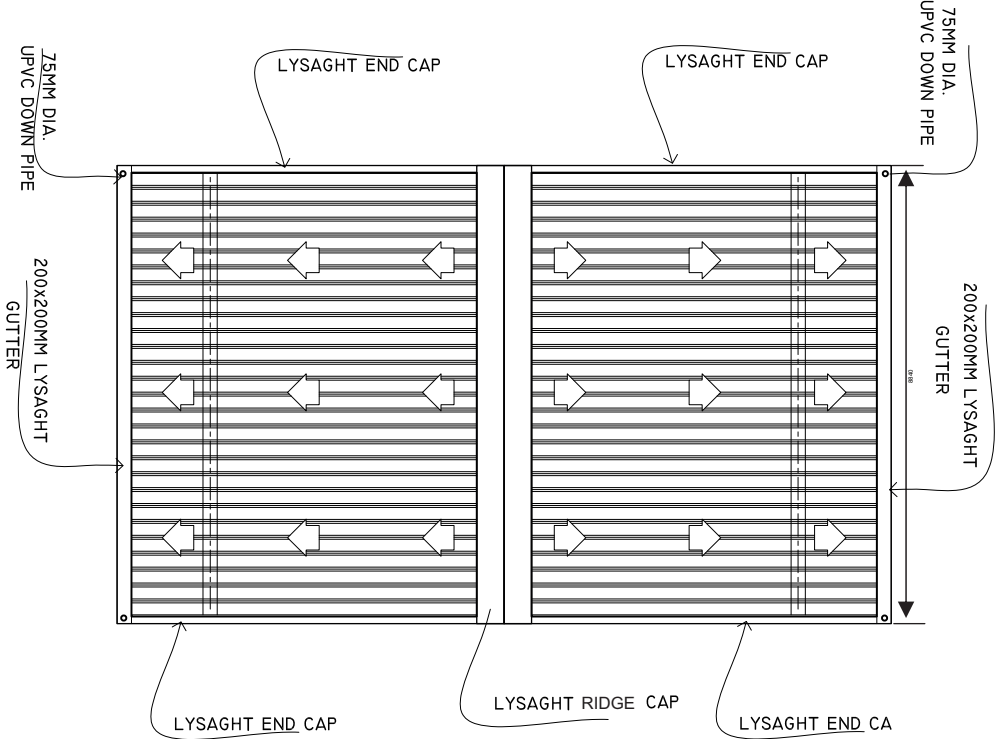
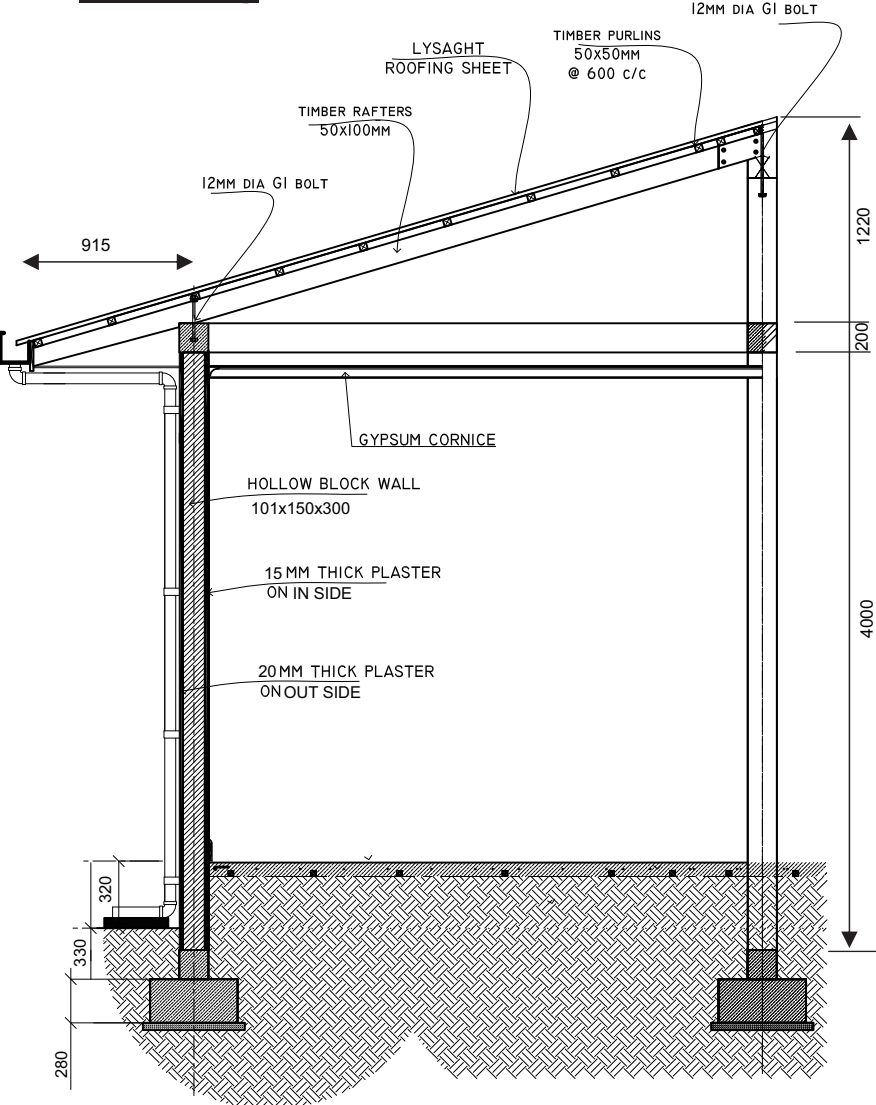

Electric and door layout

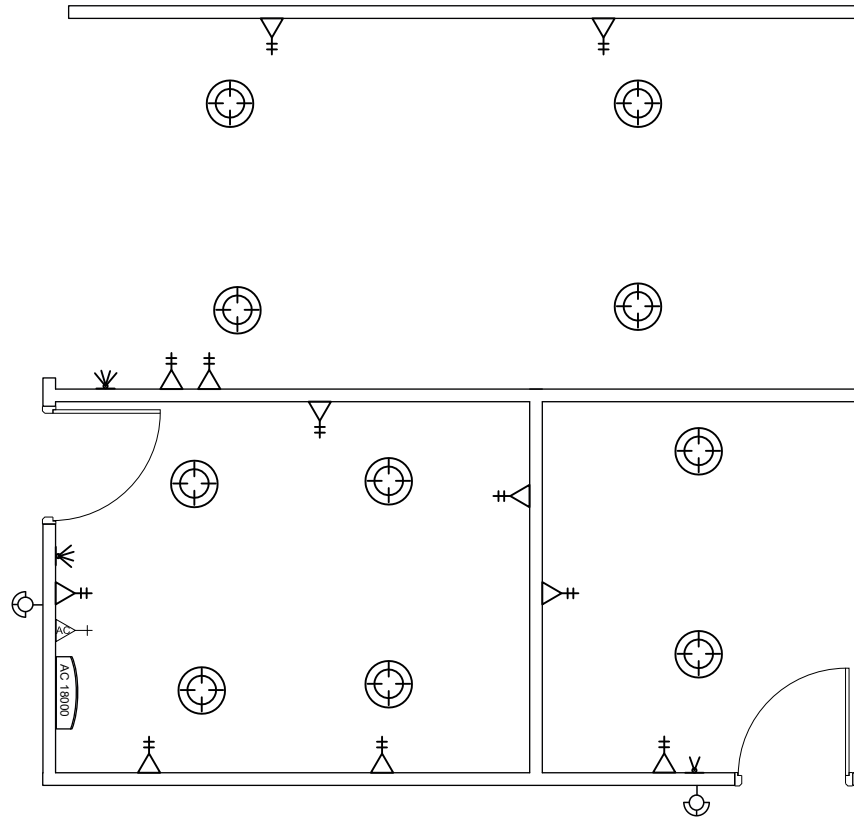

LEGEND

SYMBOL	DESCRIPTION
	LED BULB WITH 150MM DOWN LIGHT
	2 x 13 AMP SOCKET OUTLET (600MM ABOVE FFL)
	1 x 15 AMP AC SOCKET OUTLET (300MM BLW, CEILING)
	TWO GANG SWITCH
	OUT DOOR LIGHT

DOORS AND WINDOWS SCHEDULE

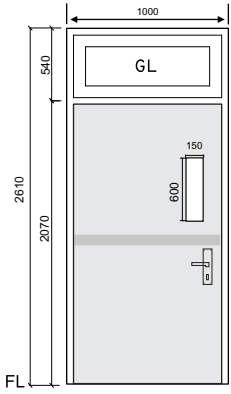
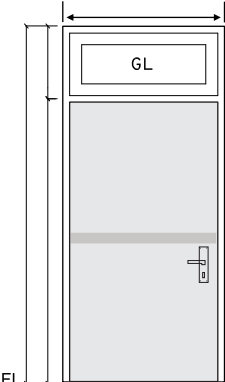
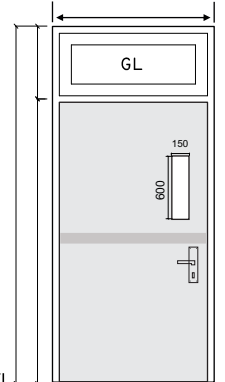
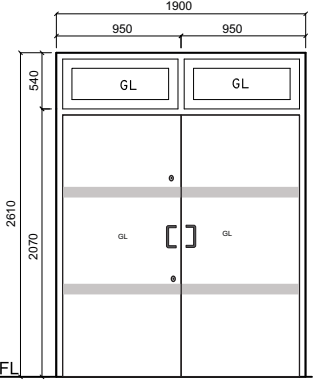
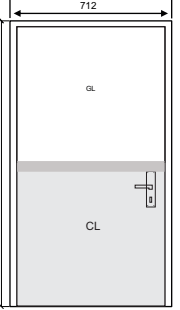
SYMBOL	D1	D2	D3	D4	Partition door
ELEVATION					
DESCRIPTION	40MM THICK OPENABLE ALUMINUM DOOR	40MM THICK OPENABLE ALUMINUM DOOR	40MM THICK OPENABLE ALUMINUM FRAMED DOOR	40MM THICK OPENABLE ALUMINUM FRAMED DOOR	40MM THICK OPENABLE ALUMINUM FRAMED DOOR
FRAME	120MM ALUMINUM FRAME 80 MICRON WHITE POWDER COATED	120MM ALUMINUM FRAME 80 MICRON WHITE POWDER COATED	120MM ALUMINUM FRAME 80 MICRON WHITE POWDER COATED	120MM ALUMINUM FRAME 80 MICRON WHITE POWDER COATED	120MM ALUMINUM FRAME 80 MICRON WHITE POWDER COATED
HARDWARE	DOOR CLOSER HANDLE LOCK BUTT HINGE STOPPER HOLDER KICKER	DOOR CLOSER HANDLE LOCK BUTT HINGE KICKER	DOOR CLOSER HANDLE LOCK BUTT HINGES KICKER	DOOR CLOSER*2 LOCK*2 BUTT HINGE STOPPER HOLDER KICKER	DOOR CLOSER LOCK BUTT HINGE STOPPER HOLDER KICKER

ALL MEASUREMENTS TO BE CHECKED ON
SITE BEFORE FABRICATION

GL = 5MM CLEAR GLASS

CL = CLADDING SHEET, WHITE POWDER
COATED ON BOTH SIDE.

Office door 2585x1040

Delivery room door 2590x1760

PHU door 2580x1040

Laboratory door 2580x1040

Consultation room door 2585x1090

Ward door 2585x1760

Ward toilet entry door 2585x1090

Ward toilet door 1 2570x990

Ward toilet door2 2570x990

Nursing station toilet 2580x840

Office toilet door 2585x480

Delivery room toilet door 2570x1065

Toilet door 2585x840

COUNTER

