

**1**  
**تصميم**

**تصميم كاسات**  
**مادة كاسات**  
**المرحلة الأولى**

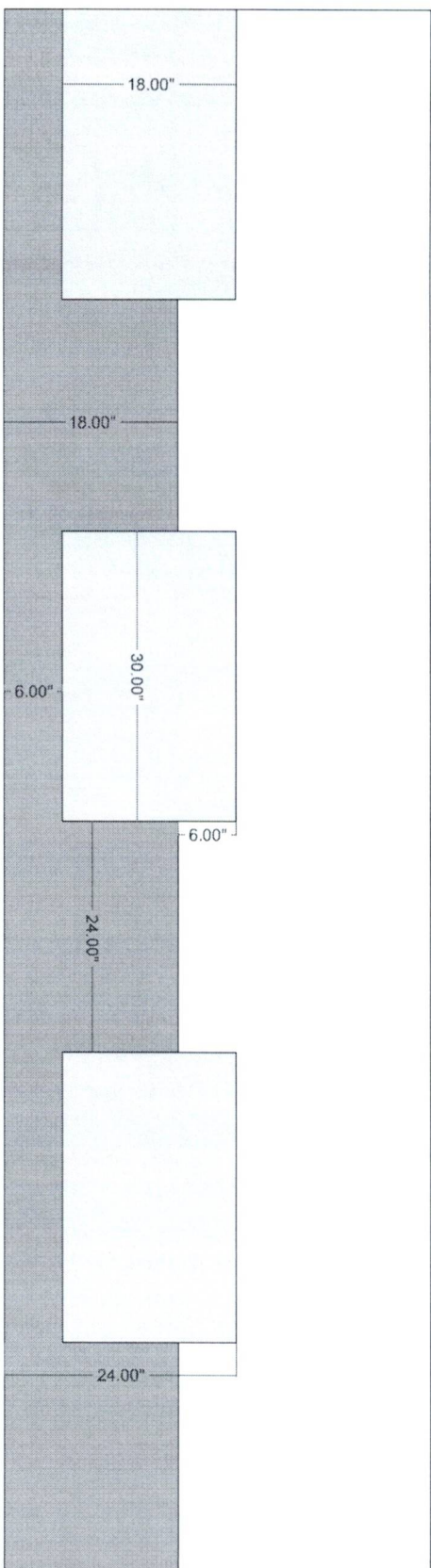
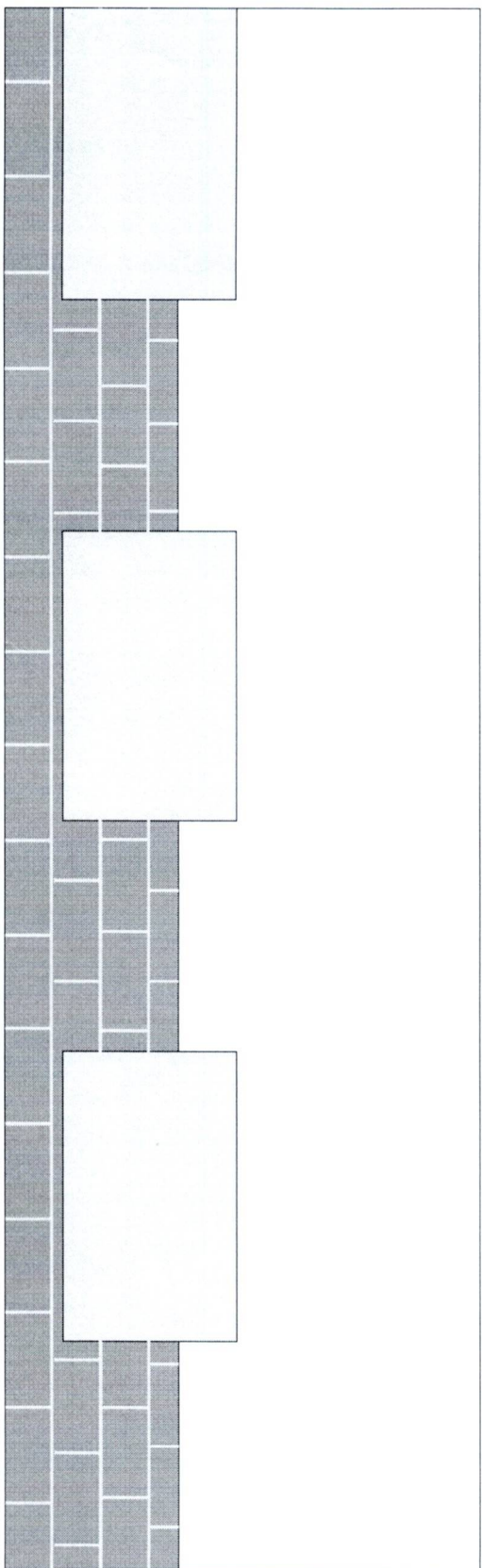

دائرة التخطيط والبناء  
القطاع التعليمي

2  
القطاع التعليمي



3  
تذکره

مجلس شورای اسلامی  
وزارت معادن

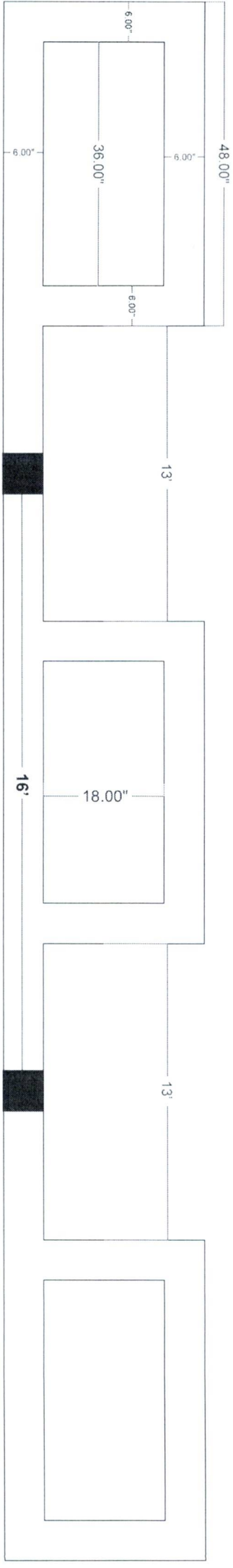



4  
تصميم

مخطط قطع عرضي

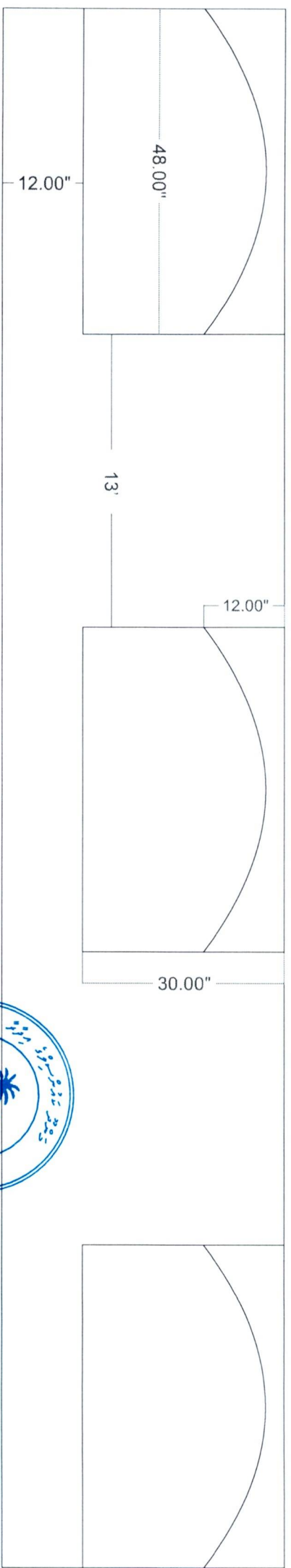
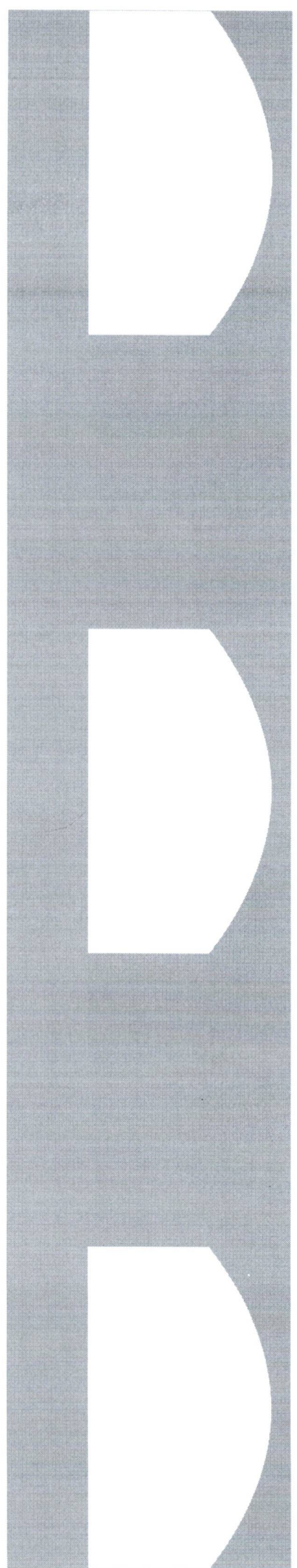

**مقدمه ۵**

سازمان مدیریت و برنامه ریزی استان خراسان جنوبی

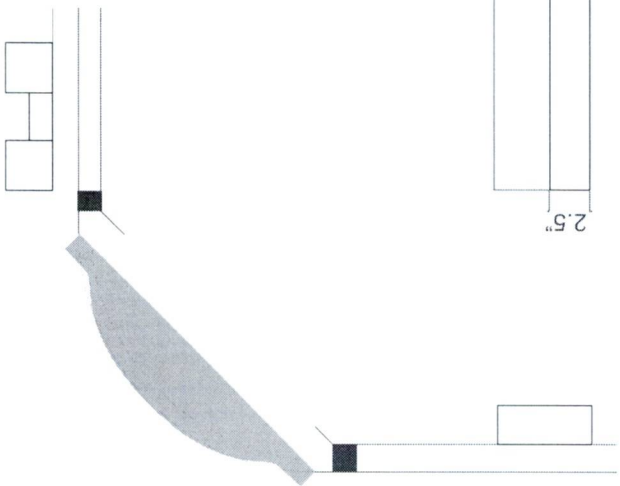
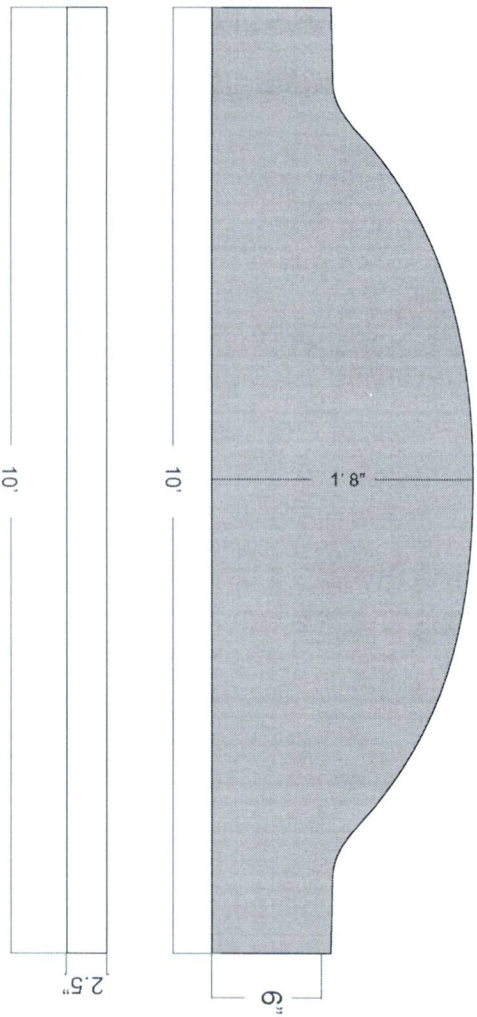

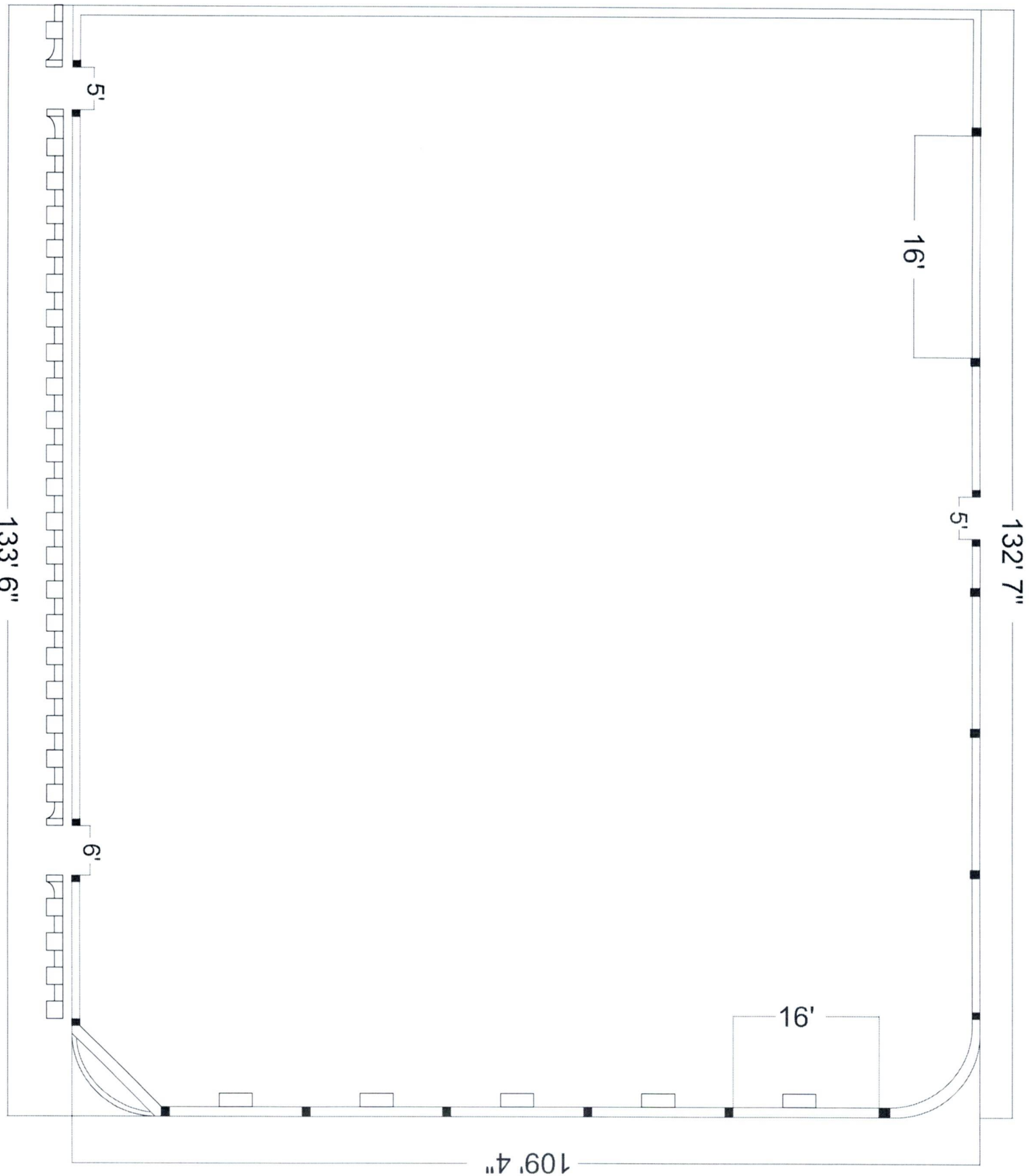

6  
 ٢٠٢٤  
 ٢٠٢٤

٢٠٢٤  
 ٢٠٢٤  
 ٢٠٢٤

