

بِسْمِ اللّٰهِ الرَّحْمٰنِ الرَّحِیْمِ

Secretariat of the Faadhippolhu Naifaru Council

Faadhippolhu Naifaru , Republic of Maldives



ފާދިބު ޖަލްސާ ސަރުކާރުގެ ސެކްރެޓަރިޓް

ދިވެހިރާއްޖޭގެ ޖުމްހޫރިއްޔާ، ފާދިބު ޖަލްސާ

## ސަލާމަތުގެ ޖަލްސާ

ފާދިބު ޖަލްސާގެ ސަރުކާރުގެ ސެކްރެޓަރިޓް ގައި ހިންގާ ސަލާމަތުގެ ޖަލްސާ ފޯރުކުރުމަށް ފާދިބު ޖަލްސާގެ ސަރުކާރުގެ ސެކްރެޓަރިޓް ގައި ހިންގާ ސަލާމަތުގެ ޖަލްސާ

ފާދިބު ޖަލްސާގެ ސަރުކާރުގެ ސެކްރެޓަރިޓް: (IUL)327-A/327/2023/334

ފާދިބު ޖަލްސާގެ ސަރުކާރުގެ ސެކްރެޓަރިޓް:

ފާދިބު ޖަލްސާގެ ސަރުކާރުގެ ސެކްރެޓަރިޓް: 11 ޔުނިވަރސަލް 2023

ފާދިބު ޖަލްސާގެ ސަރުކާރުގެ ސެކްރެޓަރިޓް: 20 ޔުނިވަރސަލް 2023



lhnaifarucouncil



www.naifaru.gov.mv



info@naifaru.gov.mv



6620068



<p> <b>20</b> <b>2023</b>  <b>14:00</b> </p>	18.1
<p> <b>20</b> <b>2023</b>  <b>14:00</b> </p>	20.1
<p>6</p>	24.1
<p>5,000/-</p>	28.1
<p>90</p>	28.2
<p>10%</p>	30.1
<p>36.1</p>	







(a) ބަލާއިރުގެ ތެރޭގައި

7. ބަލާއިރުގެ ރަޔު 7.1 ބަލާއިރުގެ ތެރޭގައި ރެޖިސްޓްރިޔު ދަނޯޝަނުގެ ތެރޭގައި،  
 ރެޖިސްޓްރިޔުގެ ދަނޯޝަނު ތެރޭގައި ހިމެނޭ ބަލާއިރުގެ ތެރޭގައި،

7.1.1 ބަލާއިރުގެ ބަލާއިރު (ސަލަޕްޓު - 1)

7.1.2 ބަލާއިރުގެ ޕްރޮސެޖް ދަނޯޝަނުގެ ތެރޭގައި ހިމެނޭ (ސަލަޕްޓު - 2)

7.1.3 ބަލާއިރުގެ ރަޔު ޕްރޮސެޖް ދަނޯޝަނުގެ ތެރޭގައި ހިމެނޭ (ސަލަޕްޓު - 3)

7.1.4 ބަލާއިރުގެ ރަޔު ޕްރޮސެޖް ދަނޯޝަނުގެ ތެރޭގައި ހިމެނޭ (ސަލަޕްޓު - 4)

7.1.5 ބަލާއިރުގެ ރަޔު ޕްރޮސެޖް ދަނޯޝަނުގެ ތެރޭގައި ހިމެނޭ (ސަލަޕްޓު - 5)

8. ބަލާއިރުގެ ރަޔު 8.1 ބަލާއިރުގެ ތެރޭގައި ހިމެނޭ ބަލާއިރުގެ ތެރޭގައި،  
 ރަޔު ޕްރޮސެޖް ދަނޯޝަނުގެ ތެރޭގައި ހިމެނޭ ބަލާއިރުގެ ތެރޭގައި،

8.2 ބަލާއިރުގެ ރަޔު ޕްރޮސެޖް ދަނޯޝަނުގެ ތެރޭގައި ހިމެނޭ ބަލާއިރުގެ ތެރޭގައި،  
 ރަޔު ޕްރޮސެޖް ދަނޯޝަނުގެ ތެރޭގައި ހިމެނޭ ބަލާއިރުގެ ތެރޭގައި،

9. ބަލާއިރުގެ ރަޔު 9.1 ބަލާއިރުގެ ތެރޭގައި ހިމެނޭ ބަލާއިރުގެ ތެރޭގައި،  
 "ބަލާއިރުގެ ރަޔު" ގެ ތެރޭގައި ހިމެނޭ ބަލާއިރުގެ ތެރޭގައި،

9.2 ބަލާއިރުގެ ރަޔު ޕްރޮސެޖް ދަނޯޝަނުގެ ތެރޭގައި ހިމެނޭ ބަލާއިރުގެ ތެރޭގައި،  
 ބަލާއިރުގެ ރަޔު ޕްރޮސެޖް ދަނޯޝަނުގެ ތެރޭގައި ހިމެނޭ ބަލާއިރުގެ ތެރޭގައި،

9.3 ބަލާއިރުގެ ރަޔު ޕްރޮސެޖް ދަނޯޝަނުގެ ތެރޭގައި ހިމެނޭ ބަލާއިރުގެ ތެރޭގައި،  
 ބަލާއިރުގެ ރަޔު ޕްރޮސެޖް ދަނޯޝަނުގެ ތެރޭގައި ހިމެނޭ ބަލާއިރުގެ ތެރޭގައި،

10. ބަލާއިރުގެ ރަޔު 10.1 ބަލާއިރުގެ ތެރޭގައި ހިމެނޭ ބަލާއިރުގެ ތެރޭގައި،  
 ރަޔު ޕްރޮސެޖް ދަނޯޝަނުގެ ތެރޭގައި ހިމެނޭ ބަލާއިރުގެ ތެރޭގައި،

10.2 10.1 ބަލާއިރުގެ ރަޔު ޕްރޮސެޖް ދަނޯޝަނުގެ ތެރޭގައި ހިމެނޭ ބަލާއިރުގެ ތެރޭގައި،  
 ބަލާއިރުގެ ރަޔު ޕްރޮސެޖް ދަނޯޝަނުގެ ތެރޭގައި ހިމެނޭ ބަލާއިރުގެ ތެރޭގައި،





16.1.4 16.1.5 16.1.6 16.1.7

16.2 16.2.1 16.2.2

16.2.1 16.2.2

16.2.1 16.2.2

16.2.1 16.2.2

16.2.1 16.2.2

16.2.1 16.2.2

16.2.1 16.2.2

16.2.1 16.2.2

16.2.1 16.2.2

16.2.1 16.2.2

16.2.1 16.2.2

16.2.1 16.2.2

16.2.1 16.2.2

16.2.1 16.2.2

16.2.1 16.2.2

16.2.1 16.2.2





( 𐎎 ) 𐎎𐎎 𐎎𐎎𐎎

- .17.1 𐎎𐎎 𐎎𐎎𐎎𐎎𐎎 𐎎𐎎𐎎 𐎎𐎎𐎎𐎎. 𐎎𐎎𐎎𐎎𐎎 𐎎𐎎𐎎 𐎎𐎎𐎎 𐎎𐎎𐎎 𐎎𐎎𐎎 𐎎𐎎𐎎
- .17.2 𐎎𐎎 𐎎𐎎𐎎 𐎎𐎎𐎎𐎎𐎎 𐎎𐎎𐎎 𐎎𐎎𐎎𐎎𐎎 𐎎𐎎𐎎𐎎𐎎.
- .17.3 𐎎𐎎 𐎎𐎎𐎎𐎎 𐎎𐎎𐎎𐎎 𐎎𐎎𐎎𐎎 𐎎𐎎𐎎𐎎𐎎 𐎎𐎎𐎎 𐎎𐎎𐎎𐎎 𐎎𐎎𐎎𐎎.
- .17.4 𐎎𐎎𐎎 𐎎𐎎𐎎𐎎 𐎎𐎎𐎎𐎎𐎎 𐎎𐎎𐎎𐎎 𐎎𐎎𐎎𐎎 𐎎𐎎𐎎𐎎 𐎎𐎎𐎎𐎎𐎎.
- .18.1 𐎎 𐎎𐎎𐎎𐎎𐎎 𐎎𐎎𐎎 𐎎𐎎𐎎𐎎 𐎎𐎎𐎎𐎎 𐎎𐎎𐎎𐎎 𐎎𐎎𐎎𐎎𐎎 𐎎𐎎𐎎𐎎.
- .18.2 𐎎 𐎎𐎎𐎎 18.1 𐎎 𐎎𐎎𐎎 𐎎𐎎𐎎𐎎𐎎 𐎎𐎎𐎎𐎎 𐎎𐎎𐎎𐎎𐎎 𐎎𐎎𐎎𐎎.
- .18.3 𐎎𐎎𐎎 𐎎𐎎𐎎 𐎎𐎎 𐎎𐎎𐎎 𐎎𐎎𐎎𐎎 𐎎𐎎𐎎𐎎𐎎.
- .19.1 𐎎𐎎 𐎎𐎎𐎎𐎎𐎎 𐎎𐎎𐎎𐎎 𐎎𐎎𐎎𐎎 𐎎𐎎𐎎 𐎎𐎎𐎎 𐎎𐎎𐎎 𐎎𐎎𐎎.
- .19. 𐎎𐎎𐎎𐎎 𐎎𐎎𐎎𐎎𐎎 𐎎𐎎𐎎𐎎 𐎎𐎎𐎎𐎎

( 𐎎 ) 𐎎𐎎 𐎎𐎎𐎎 𐎎𐎎𐎎𐎎 𐎎𐎎𐎎

- .20.1 𐎎 𐎎𐎎𐎎𐎎𐎎 𐎎𐎎𐎎 𐎎𐎎𐎎𐎎 𐎎𐎎𐎎𐎎 𐎎𐎎𐎎𐎎 𐎎𐎎𐎎𐎎
- .20.2 𐎎𐎎 𐎎𐎎𐎎 𐎎𐎎𐎎𐎎 𐎎𐎎𐎎𐎎 𐎎𐎎𐎎𐎎 𐎎𐎎𐎎𐎎.
- .20.3 𐎎𐎎 𐎎𐎎𐎎𐎎 𐎎𐎎𐎎𐎎 𐎎𐎎𐎎𐎎 𐎎𐎎𐎎𐎎 𐎎𐎎𐎎𐎎
- .21.1 𐎎𐎎𐎎 𐎎𐎎𐎎𐎎 𐎎𐎎𐎎𐎎𐎎 𐎎𐎎𐎎𐎎 𐎎𐎎𐎎𐎎



22.2

21.2 ބަލަންނަނިންނަގެންނަ އަދި ބަލަންނަނިންނަގެންނަ އަދި ބަލަންނަނިންނަގެންނަ... ބަލަންނަނިންނަގެންނަ އަދި ބަލަންނަނިންނަގެންނަ...

22 ބަލަންނަނިންނަގެންނަ

22.1 ބަލަންނަނިންނަގެންނަ ބަލަންނަނިންނަގެންނަ ބަލަންނަނިންނަގެންނަ...

22.1.1 ބަލަންނަނިންނަގެންނަ

22.1.1 ބަލަންނަނިންނަގެންނަ ބަލަންނަނިންނަގެންނަ...

22.1.2 ބަލަންނަނިންނަގެންނަ

22.1.2 ބަލަންނަނިންނަގެންނަ ބަލަންނަނިންނަގެންނަ...

22.1.3 ބަލަންނަނިންނަގެންނަ

22.1.3 ބަލަންނަނިންނަގެންނަ ބަލަންނަނިންނަގެންނަ... (ބަލަންނަނިންނަގެންނަ)

23 ބަލަންނަނިންނަގެންނަ

23.1 ބަލަންނަނިންނަގެންނަ ބަލަންނަނިންނަގެންނަ 22.1 ބަލަންނަނިންނަގެންނަ...

24 ބަލަންނަނިންނަގެންނަ

24.1 ބަލަންނަނިންނަގެންނަ ބަލަންނަނިންނަގެންނަ... (G-23/2022) ބަލަންނަނިންނަގެންނަ...

25 ބަލަންނަނިންނަގެންނަ

25.1 ބަލަންނަނިންނަގެންނަ ބަލަންނަނިންނަގެންނަ... ބަލަންނަނިންނަގެންނަ...

26 ބަލަންނަނިންނަގެންނަ

26.1 ބަލަންނަނިންނަގެންނަ ބަލަންނަނިންނަގެންނަ... ބަލަންނަނިންނަގެންނަ...







30.4 30.4  
 30.4 30.4  
 30.4 30.4

31.1 31.1  
 31.1 31.1  
 31.1 31.1  
 31.1 31.1  
 31.1 31.1  
 31.1 31.1  
 31.1 31.1  
 31.1 31.1  
 31.1 31.1

31.2 31.2  
 31.2 31.2  
 31.2 31.2  
 31.2 31.2  
 31.2 31.2  
 31.2 31.2  
 31.2 31.2  
 31.2 31.2  
 31.2 31.2

31.3 31.3  
 31.3 31.3  
 31.3 31.3  
 31.3 31.3  
 31.3 31.3  
 31.3 31.3  
 31.3 31.3  
 31.3 31.3  
 31.3 31.3

31.4 31.4  
 31.4 31.4  
 31.4 31.4  
 31.4 31.4  
 31.4 31.4  
 31.4 31.4  
 31.4 31.4  
 31.4 31.4  
 31.4 31.4

32.1 32.1  
 32.1 32.1  
 32.1 32.1  
 32.1 32.1  
 32.1 32.1  
 32.1 32.1  
 32.1 32.1  
 32.1 32.1  
 32.1 32.1

32.1  
 32.1  
 32.1



3 - 3

33. 33.1 33.2 33.3 33.4 33.5 34. 34.1 34.2 34.3 35. 35.1 35.2

- 33.1 "33.2 33.3 33.4 33.5 34. 34.1 34.2 34.3 35. 35.1 35.2
- 33.1 "33.2 33.3 33.4 33.5 34. 34.1 34.2 34.3 35. 35.1 35.2
- 33.2 "33.3 33.4 33.5 34. 34.1 34.2 34.3 35. 35.1 35.2
- 33.3 "33.4 33.5 34. 34.1 34.2 34.3 35. 35.1 35.2
- 33.4 "33.5 34. 34.1 34.2 34.3 35. 35.1 35.2
- 33.5 "34. 34.1 34.2 34.3 35. 35.1 35.2
34. 34.1 34.2 34.3 35. 35.1 35.2
- 34.1 "34.2 34.3 35. 35.1 35.2
- 34.2 "34.3 35. 35.1 35.2
- 34.3 "35. 35.1 35.2
35. 35.1 35.2
- 35.1 "35.2
- 35.2 "35.1 35.2















# 1 1

1 1



lhnaifarucouncil



www.naifaru.gov.mv



info@naifaru.gov.mv







6620068





FOR INSTALLATION DETAILS OF PARK EQUIPMENTS  
PLEASE REFER TO STRUCTURAL INSTALLATION OF PARK EQUIPMENTS

-  ARTIFICIAL GRASS CARPET
-  100 MM THICK REINFORCED CONCRETE SLAB
-  WALL MOUNT OUTDOOR, WATERPROOF LIGHTS
-  OUTDOOR, WATERPROOF GARDEN LIGHTS
-  ELECTRICAL DISTRIBUTION BOX

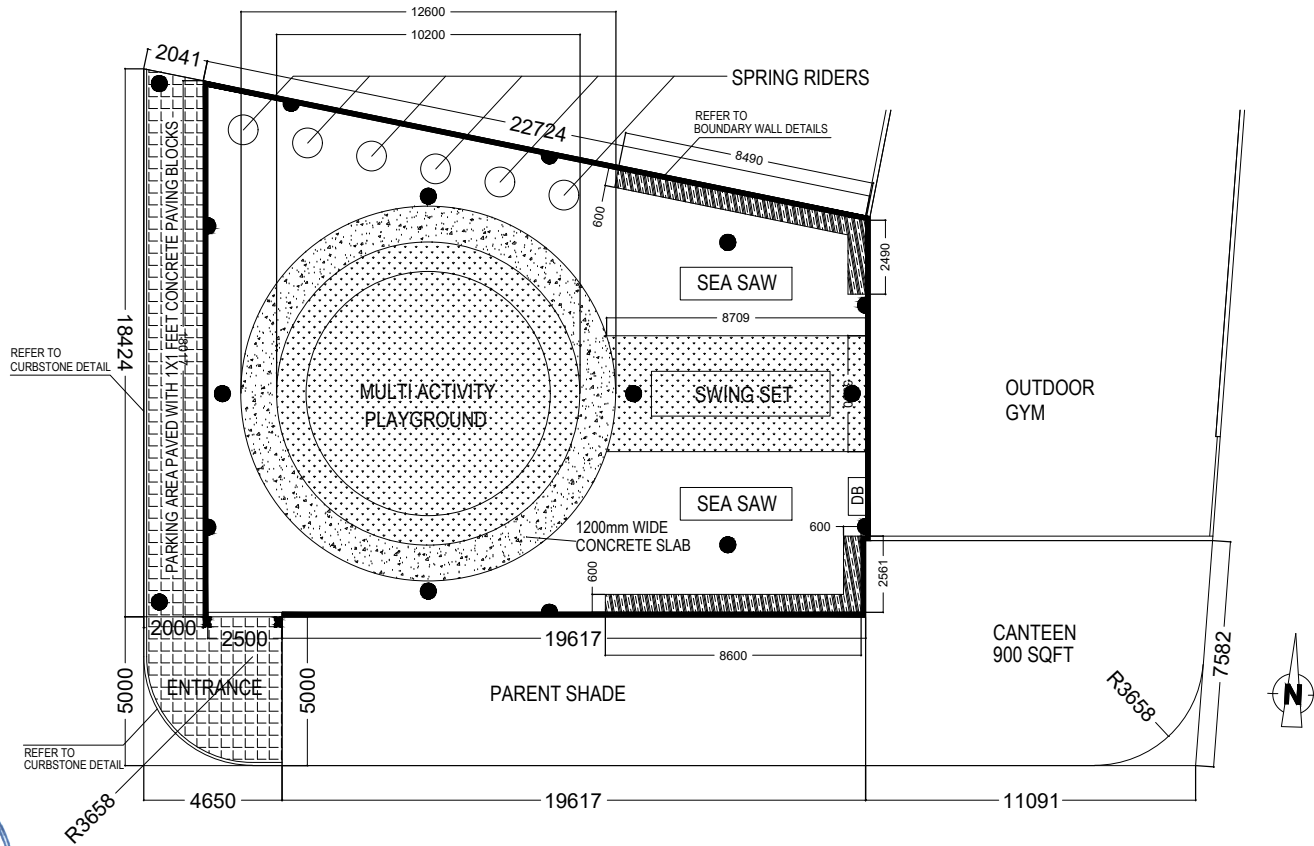

<b>Secretariat of the Faadhippolhu Naifaru Council</b> Faadhippolhu Naifaru , Republic of Maldives		ދުވަހުގެ ސަރުކާރުގެ ސަރުކާރުގެ ސަރުކާރު ދުވަހުގެ ސަރުކާރުގެ ސަރުކާރުގެ ސަރުކާރު	DESIGN:	<b>Ismail Yamaan Yoosuf</b>
			DRAWN BY:	<b>Ismail Yamaan Yoosuf</b>
			PROJECT:	<b>OUTDOOR GYM &amp; PARK</b>
			DATE:	06- 12- 2023

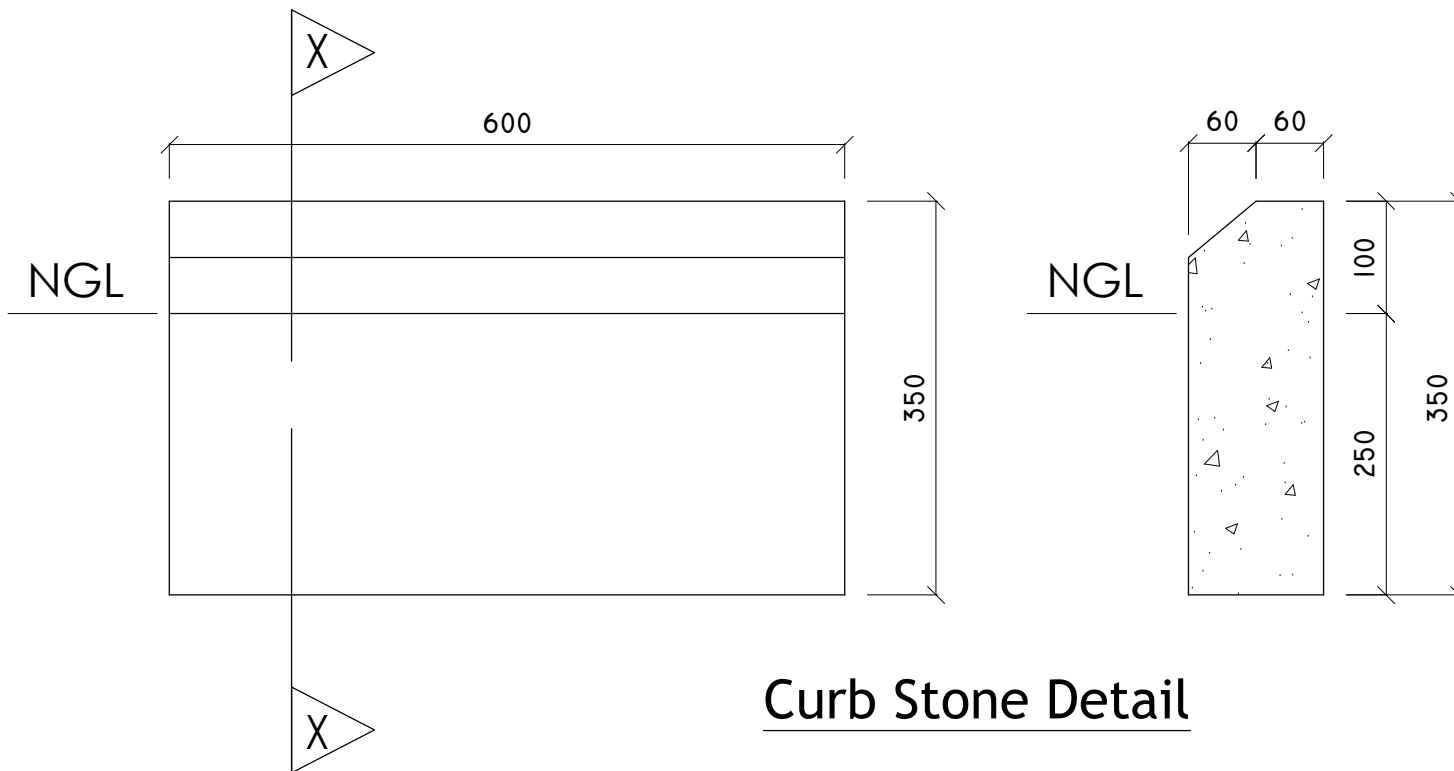

Curb Stone Detail



DESIGN:	Sharwath Ibrahim
DRAWN BY:	Sharwath Ibrahim
PROJECT:	Parents Hiyya
DATE:	22-11-2023



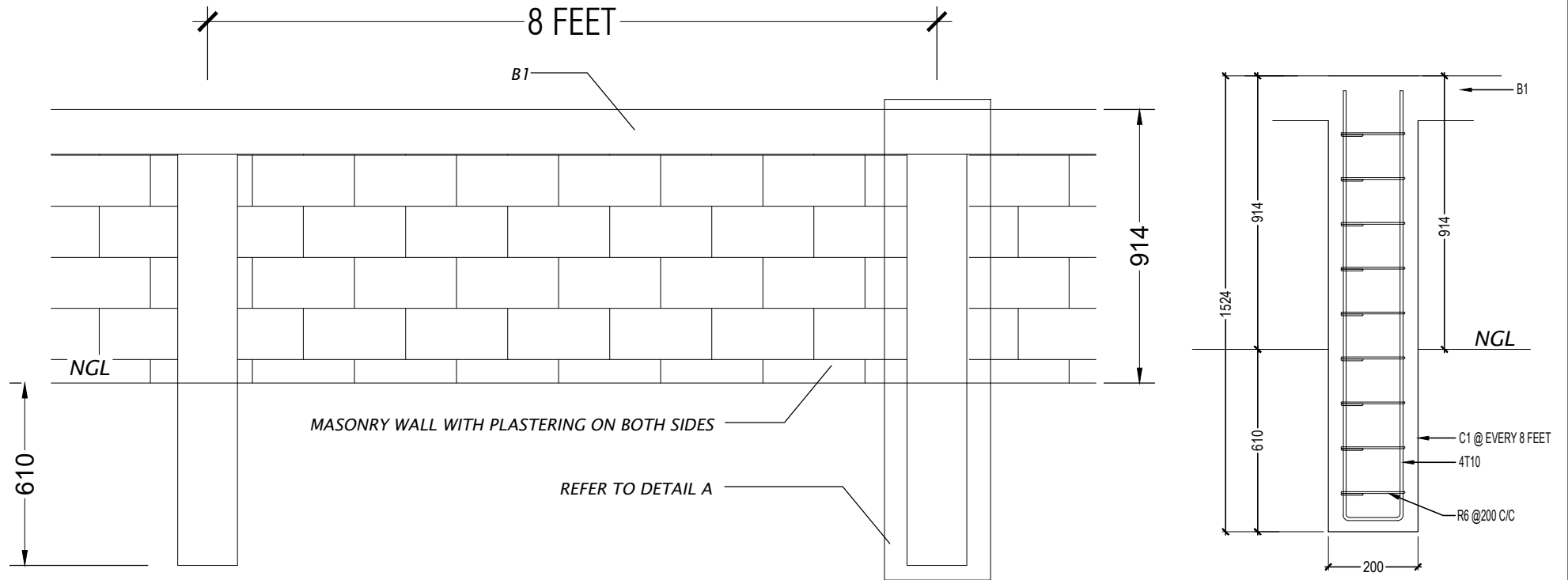

\*CHECK ALL MEASUREMENTS ON SITE BEFORE FABRICATION

BOUNDARY WALL DETAIL

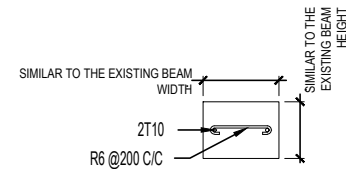

\*CHECK ALL MEASUREMENTS ON SITE BEFORE FABRICATION

B1



- ▮ WALL MOUNT OUTDOOR, WATERPROOF LIGHTS
- OUTDOOR, WATERPROOF GARDEN LIGHTS
- DB ELECTRICAL DISTRIBUTION BOX

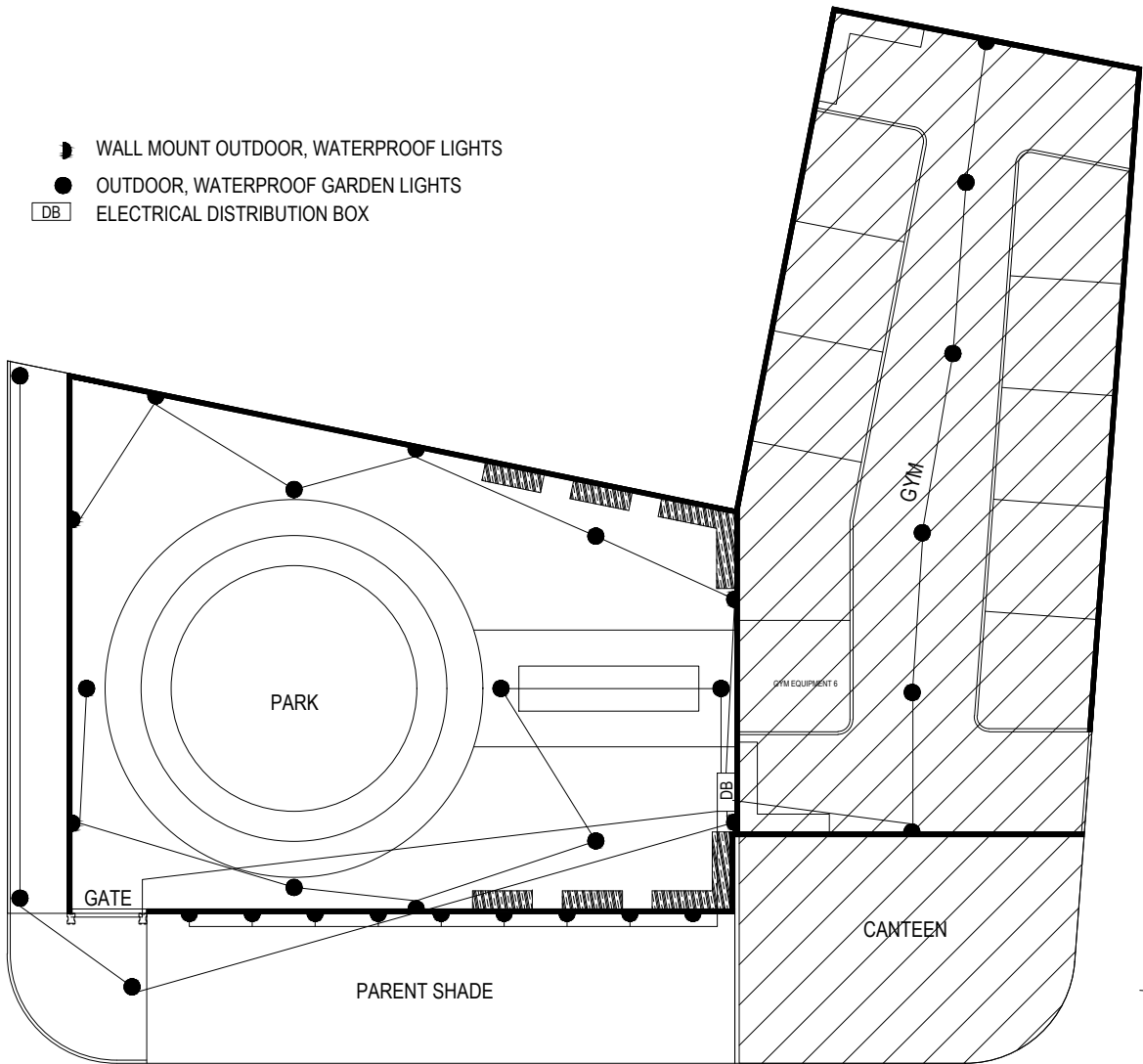

ELECTRC LAYOUT



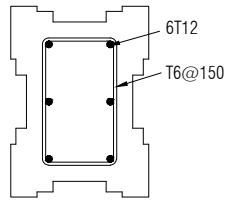

C1

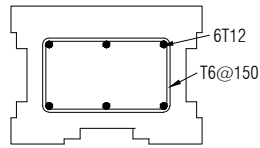

B1

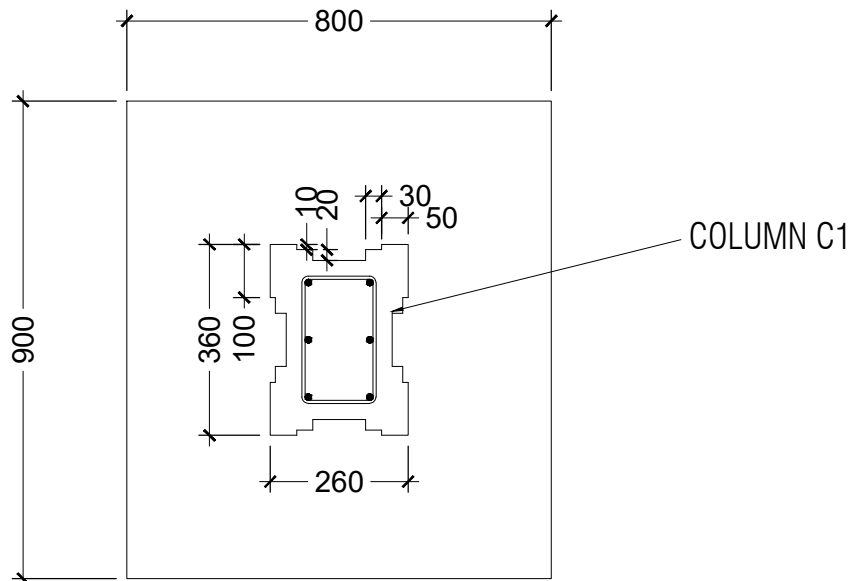

TOP VIEW

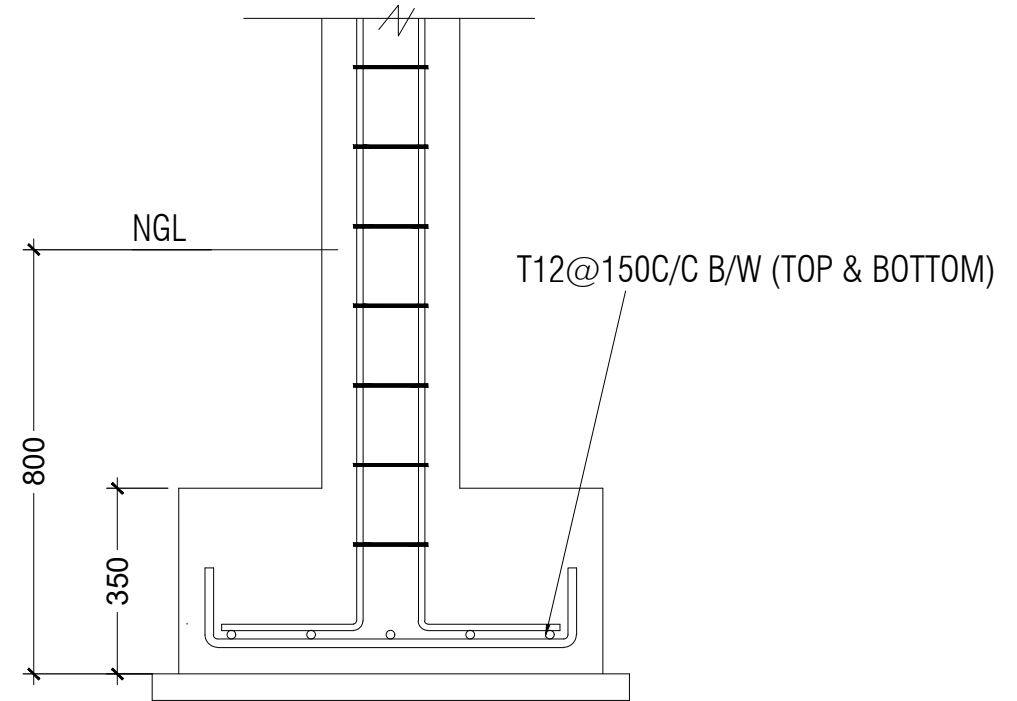

SECTION X



# GATE FOUNDATION DETAIL

<b>Secretariat of the Faadhippolhu Naifaru Council</b> Faadhippolhu Naifaru , Republic of Maldives		ދިވެހިރާއްޖޭގެ ސަރުކާރުގެ ގެޒެޓް ގައި ބަޔާންކޮށްފައިވާ ގޮތުގައި ފާއިތުވި ސަރުކާރުގެ ސިޔާސަތުގެ ދަށުން	DESIGN:	<b>Ismail Yamaan Yoosuf</b>
			DRAWN BY:	<b>Ismail Yamaan Yoosuf</b>
			PROJECT:	<b>OUTDOOR GYM &amp; PARK</b>
			DATE:	06- 12- 2023

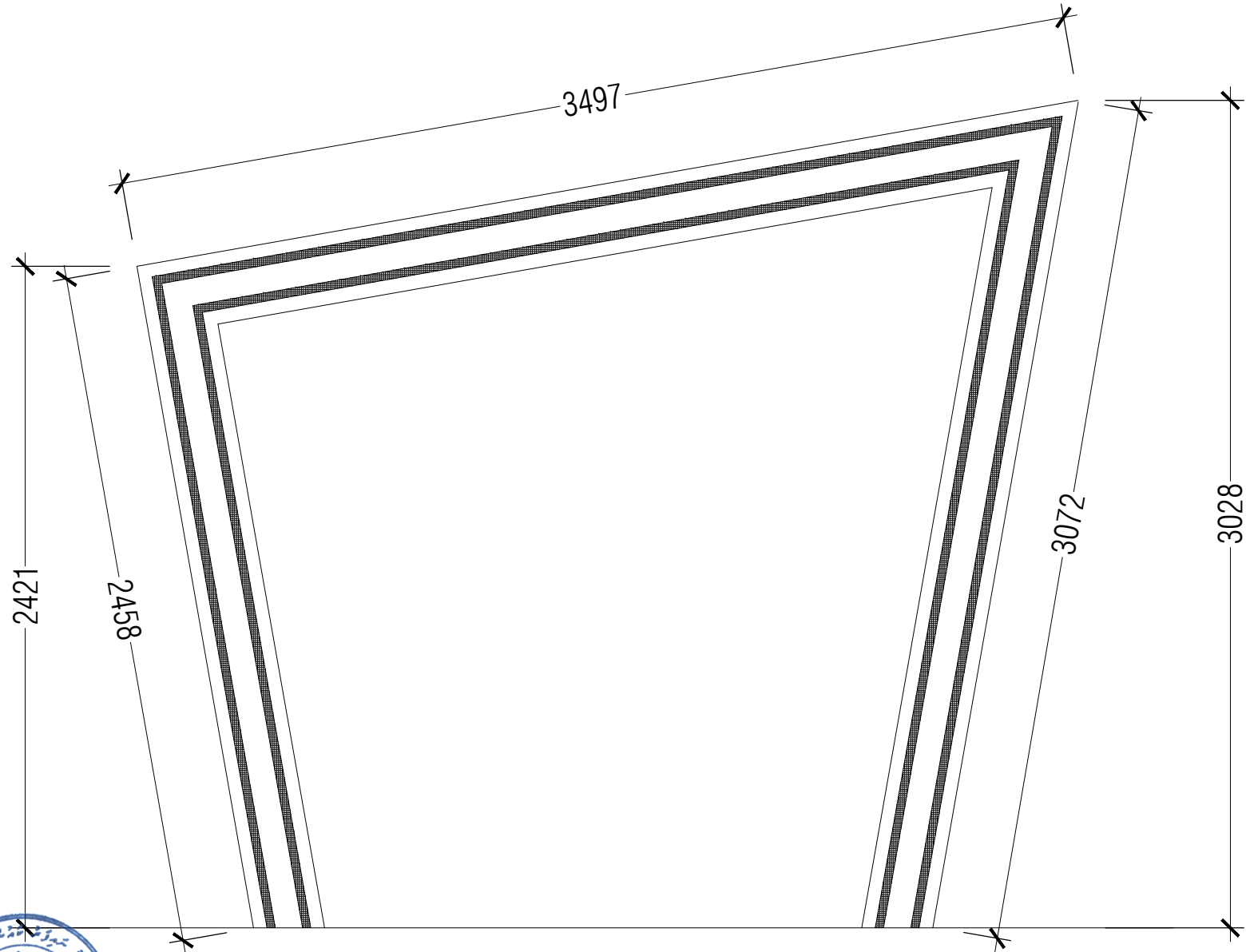

### GATE FRONT



Secretariat of the Faadhippolhu Naifaru Council  
Faadhippolhu Naifaru , Republic of Maldives



ދިވެހިރާއްޖޭގެ ސަރުކާރުގެ ގެޒެޓްގައި ބަޔާންކޮށްފައިވާ ގޮތުން  
ފާއުދީބު ނާއިފަރު ކައުންސިލްގެ ސަރުކާރުގެ ގެޒެޓްގައި ބަޔާންކޮށްފައިވާ ގޮތުން

DESIGN:	Ismail Yamaan Yoosuf
DRAWN BY:	Ismail Yamaan Yoosuf
PROJECT:	OUTDOOR GYM & PARK
DATE:	06- 12- 2023

# රාජ්‍ය සේවා

නියුක්තියේ සේවා



lhnaifarucouncil



[www.naifaru.gov.mv](http://www.naifaru.gov.mv)



[info@naifaru.gov.mv](mailto:info@naifaru.gov.mv)



6620068





1 - 1

1 - 1

#	1	2
1 - 1		
1	✓	1
2	✓	2
3		3
4		4
5	✓	5
6	✓	6
7		7
8	✓	8
9		9
10		10
1 - 2		
11		11
12		12
13		13
1 - 3		
14		14
15		15
16		16
17		17
1 - 4		
18		18
19		19







3 ބަލާލާށެވެ

ބަލާލާށެވެ ފަރާތްތަކުގެ ނަންބަރުތަކުގެ ތެރެއިން

1. ބަލާލާށެވެ ފަރާތްތަކުގެ ނަންބަރުތަކުގެ ތެރެއިން	
ނަންބަރު	
ފަރާތްތަކުގެ ނަންބަރުތަކުގެ ތެރެއިން	
ފަރާތްތަކުގެ ނަންބަރު	
ފަރާތްތަކުގެ ނަންބަރު	
ފަރާތްތަކުގެ ނަންބަރު	
ފަރާތްތަކުގެ ނަންބަރު	
ފަރާތްތަކުގެ ނަންބަރު	
ފަރާތްތަކުގެ ނަންބަރު	
ފަރާތްތަކުގެ ނަންބަރު	
2. ފަރާތްތަކުގެ ނަންބަރުތަކުގެ ތެރެއިން (ފަރާތްތަކުގެ ނަންބަރުތަކުގެ ތެރެއިން ބަލާލާށެވެ، ފަރާތްތަކުގެ ނަންބަރުތަކުގެ ތެރެއިން ބަލާލާށެވެ، ފަރާތްތަކުގެ ނަންބަރުތަކުގެ ތެރެއިން ބަލާލާށެވެ)	
ނަންބަރު	މަތީ
	މަތީ ފަރާތްތަކުގެ ތެރެއިން
	މަތީ ފަރާތްތަކުގެ ތެރެއިން
	މަތީ ފަރާތްތަކުގެ ތެރެއިން
3. ފަރާތްތަކުގެ ނަންބަރުތަކުގެ ތެރެއިން	
	1
	2
	3
	4
	5
	6
	7
	8
	9

ފަރާތްތަކުގެ ނަންބަރުތަކުގެ ތެރެއިން ބަލާލާށެވެ، ފަރާތްތަކުގެ ނަންބަރުތަކުގެ ތެރެއިން ބަލާލާށެވެ.



4 ޖަވާބު

މި ސަރަޙައްދުގައި ބޭނުންވާ ގޮތްތައް

ސަލާމަތުގެ ސަފުހާ ފޯމުގެ ފުރުޞަތު ހޯދާ ފަރާތްތަކުގެ ނަންބަރު			
ނަންބަރު	ފޯމުގެ ނަންބަރު	ފޯމުގެ ނަންބަރު	#
			1
			2
			3
			4
			5
ޖަވާބު			

ސަލާމަތުގެ ސަފުހާ ފޯމުގެ ފުރުޞަތު ހޯދާ ފަރާތްތަކުގެ ނަންބަރު

_____	_____
_____	_____
_____	_____
_____	_____
_____	_____
_____	_____
_____	_____
_____	_____
_____	_____
_____	_____



3 (މަސް) ގަދަ ދަނޑު ބޭނުންކުރާ ފަރާތްތަކުގެ ނަންބަރުތަކުގެ ސަރަޙައްދު

**މަސް ދަނޑު ބޭނުންކުރާ ފަރާތްތަކުގެ ނަންބަރުތަކުގެ ސަރަޙައްދު ބަލާ ފޯމު**  
(މަސް ދަނޑު ބޭނުންކުރާ ފަރާތްތަކުގެ ނަންބަރުތަކުގެ ސަރަޙައްދު ބަލާ ފޯމު ފުރިހަމަކުރުމަށް ފަހު ފޮނުވާލަން ޖެހޭނެ ސަރަޙައްދު ބަލާ ފޯމު)

#	މަސް ދަނޑު ބޭނުންކުރާ ފަރާތްތަކުގެ ނަންބަރު	މަސް ދަނޑު ބޭނުންކުރާ ފަރާތްތަކުގެ ނަންބަރު	މަސް ދަނޑު ބޭނުންކުރާ ފަރާތްތަކުގެ ނަންބަރު
.1			
.2			
.3			
.4			
.5			
.6			
.7			
.8			
.9			
.10			

**މަސް ދަނޑު ބޭނުންކުރާ ފަރާތްތަކުގެ ނަންބަރުތަކުގެ ސަރަޙައްދު ބަލާ ފޯމު**

މަސް ދަނޑު ބޭނުންކުރާ ފަރާތްތަކުގެ ނަންބަރު: \_\_\_\_\_

މަސް ދަނޑު ބޭނުންކުރާ ފަރާތްތަކުގެ ނަންބަރު: \_\_\_\_\_

މަސް ދަނޑު ބޭނުންކުރާ ފަރާތްތަކުގެ ނަންބަރު: \_\_\_\_\_

މަސް ދަނޑު ބޭނުންކުރާ ފަރާތްތަކުގެ ނަންބަރު: \_\_\_\_\_

މަސް ދަނޑު ބޭނުންކުރާ ފަރާތްތަކުގެ ނަންބަރު: \_\_\_\_\_

މަސް ދަނޑު ބޭނުންކުރާ ފަރާތްތަކުގެ ނަންބަރު: \_\_\_\_\_

މަސް ދަނޑު ބޭނުންކުރާ ފަރާތްތަކުގެ ނަންބަރު: \_\_\_\_\_

މަސް ދަނޑު ބޭނުންކުރާ ފަރާތްތަކުގެ ނަންބަރު: \_\_\_\_\_

މަސް ދަނޑު ބޭނުންކުރާ ފަރާތްތަކުގެ ނަންބަރު: \_\_\_\_\_



6 ޖަދުވަލު

ބަލާ ފަދަ ގޮތްތަކާ ގުޅިގެން ( 20 ސަތަވާއި ޖަދުވަލުގެ ގޮތުގައި ޖަހާލެވެނީ )

1.

ޖަދުވަލު / ބަލާ ގޮތް	ބަލާ ގޮތް	#
50%	<p>ނުވަނަ ގޮތެއްގައި</p> $Marks = \frac{\text{Minimum Price}}{\text{Proposed Price}} \times 50\%$	1.1
20%	<p>ބަލާ ގޮތުގައި ގަތިވަޅުގެ ބަލާ ގޮތުގައި ހަރުދާތަކާ ގުޅިގެން ބަލާ ގޮތުގައި ޖަހާލެވެނީ. ބަލާ ގޮތުގައި ޖަހާލެވެނީ، ބަލާ ގޮތުގައި ޖަހާލެވެނީ (ސަތަވާއި ޖަދުވަލު) ޖަހާލެވެނީ ޖަހާލެވެނީ 4 ޖަހާލެވެނީ ޖަހާލެވެނީ. ޖަހާލެވެނީ ޖަހާލެވެނީ 20 ޖަހާލެވެނީ ޖަހާލެވެނީ.</p>	1.2
10%	<p>ދެވަނަ ގޮތެއްގައި (ފަދަ ގޮތެއްގައި 3 ޖަހާލެވެނީ ޖަހާލެވެނީ ޖަހާލެވެނީ ޖަހާލެވެނީ)</p> <p>150,000 ޖަހާލެވެނީ ޖަހާލެވެނީ ޖަހާލެވެނީ 10 ޖަހާލެވެނީ</p> <p>100,000 ޖަހާލެވެނީ ޖަހާލެވެނީ ޖަހާލެވެނީ 7.5 ޖަހާލެވެނީ</p> <p>75,000 ޖަހާލެވެނީ ޖަހާލެވެނީ ޖަހާލެވެނީ 5 ޖަހާލެވެނީ</p> <p>50,000 ޖަހާލެވެނީ ޖަހާލެވެނީ ޖަހާލެވެނީ 2.5 ޖަހާލެވެނީ</p>	1.3
20%	<p>ބަލާ ގޮތުގައި ނުވަނަ ގޮތެއްގައި ޖަހާލެވެނީ</p> $Marks = \frac{\text{Minimum period}}{\text{Proposed Period}} \times 25\%$	1.4

2.

ނަންބަރު	ގޮތް	ގަތިވަޅުގެ ގޮތްތައް
✓		<p>ބަލާ ގޮތުގައި ގަތިވަޅުގެ ގޮތްތަކާ ގުޅިގެން ބަލާ ގޮތުގައި ޖަހާލެވެނީ (G-23/2022) ޖަހާލެވެނީ</p> <p>ޖަހާލެވެނީ ޖަހާލެވެނީ</p>



## Form of Tender Security (Bank Guarantee)

The Issuing Bank shall fill in this Bank Guarantee Form in accordance with the instructions indicated.

..... {Bank's Name, and Address of Issuing Branch or Office}

**Beneficiary:** {Name and Address of Employer}

**Date:**

**TENDER GUARANTEE No.:** \_\_\_\_\_

We have been informed that \_\_\_\_\_ {name of the Tenderer} (hereinafter called "the Tenderer") has submitted to you its Tender dated \_\_\_\_\_ (hereinafter called "the Tender") for the execution of \_\_\_\_\_ {name of contract} under Invitation for Tenders No. \_\_\_\_\_ ("the IFB").

Furthermore, we understand that, according to your conditions, Tenders must be supported by a Tender guarantee.

At the request of the Tenderer, we \_\_\_\_\_ {name of Bank} hereby irrevocably undertake to pay you any sum or sums not exceeding in total an amount of \_\_\_\_\_ [amount in figures] (\_\_\_\_\_)

[amount in words] upon receipt by us of your first demand in writing accompanied by a written statement stating that the Tenderer is in breach of its obligation(s) under the Tender conditions, because the Tenderer:

(a) has withdrawn its Tender during the period of Tender validity specified by the Tenderer in the Form of Tender; or

(b) having been notified of the acceptance of its Tender by the Employer during the period of Tender validity, (i) fails or refuses to execute the Contract Form, if required, or (ii) fails or refuses to furnish the performance security, in accordance with the ITB.

This guarantee will expire: (a) if the Tenderer is the successful Tenderer, upon our receipt of copies of the contract signed by the Tenderer and the performance security issued to you upon the instruction of the Tenderer; and (b) if the Tenderer is not the successful Tenderer, upon the earlier of (i) our receipt of a copy your notification to the Tenderer of the name of the successful Tenderer; or (ii) {insert date} twenty-eight days after the expiration of the Tenderer's Tender.

Consequently, any demand for payment under this guarantee must be received by us at the office on or before that date.

This guarantee is subject to the Uniform Rules for Demand Guarantees, ICC Publication No. 458

[Signature(s)]



ދިވެހިރާއްޖޭގެ ޖުމްހޫރިއްޔާ ގުޅިގެން

## Performance Security

[The issuing bank, as requested by the successful Contractor, shall fill in this form in accordance with the instructions indicated]

Date: [insert date (as day, month, and year)]

Title of the procurement: [Insert general title of the procurement]

Procurement Reference No: [insert reference]

Bank's Branch or Office: [insert complete name of Guarantor]

Beneficiary: [insert complete name of Employer/Procuring Entity]

Performance Guarantee No:

We have been informed that ..... [name of the Contractor], (hereinafter called “the Contractor”) has entered into Contract No. .... [procurement reference number of the Contract]. dated [insert day and month], [insert year], with you, for the execution of ..... [name of contract and brief description of Works] (hereinafter called “the Contract”).

Furthermore, we understand that, according to the conditions of the Contract, a performance guarantee is required.

At the request of the Contractor, we ..... [name of the Bank] hereby irrevocably undertake to pay you any sum or sums not exceeding in total an amount of ..... [name of the currency and amount in figures] 1.... (. . . . . [amount in words]) such sum being payable in the types and proportions of currencies in which the Contract Price is payable, upon receipt by us of your first demand in writing accompanied by a written statement stating that the Contractor is in breach of its obligation(s) under the Contract, without your needing to prove or to show grounds for your demand or the sum specified therein. This guarantee shall expire, no later than the .... day of . . . . . , . . . . . 2, and any demand for payment under it must be received by us at this office on or before that date. The Guarantor agrees to a one-time extension of this guarantee for a period not to exceed .... [six months] [one year], in response to the Employer’s written request for such extension, such request to be presented to the Guarantor before the expiry of the guarantee.

This guarantee is subject to the Uniform Rules for Demand Guarantees, ICC Publication No. 458, except that subparagraph (ii) of Sub-article 20(a) is hereby excluded.

..... [Seal of Bank and Signature(s)]

### Note: -

All italicized text is for guidance on how to prepare this demand guarantee and shall be deleted from the final document.

**1** The Guarantor shall insert an amount representing the percentage of the Contract Price specified in the Contract and denominated either in the currency (ies) of the Contract or a freely convertible currency acceptable to the Employer.

**2** Insert the date twenty-eight days after the expected completion date. The Employer should note that in the event of an extension of the time for completion of the Contract, the Employer would need to request an extension of this guarantee from the Guarantor. Such request must be in writing and must be made prior to the expiration date established in the guarantee.



# Advance Payment Security

[The bank, as requested by the successful Contractor, shall fill in this form in accordance with the instructions indicated.]

Date: [insert date (as day, month, and year)]

Title of the Procurement: [Insert general title of the procurement]

Procurement Reference No: [insert reference]

[Issuing bank's letterhead]

Beneficiary: [insert legal name and address of Procuring Entity]

ADVANCE PAYMENT GUARANTEE No.: [insert Advance Payment Guarantee no.]

Advance Payment Guarantee No:

We have been informed that ..... [name of the Contractor] (hereinafter called "the Contractor") has entered into Contract No..... [procurement reference number of the Contract], dated [insert day and month], [insert year] with you, for the execution of ..... [name of contract and brief description of Works] (hereinafter called "the Contract").

Furthermore, we understand that, according to the Conditions of the Contract, an advance payment in the sum ..... [name of the currency and amount in figures] 1 (..... [amount in words]) is to be made against an advance payment guarantee.

At the request of the Contractor, we ..... [name of the Bank]. hereby irrevocably undertake to pay you any sum or sums not exceeding in total an amount of ..... [name of the currency and amount in figures] \* (..... [amount in words]) upon receipt by us of your first demand in writing accompanied by a written statement stating that the Contractor is in breach of its obligation under the Contract because the Contractor used the advance payment for purposes other than the costs of mobilization in respect of the Works.

It is a condition for any claim and payment under this guarantee to be made that the advance payment referred to above must have been received by the Contractor on its account number ..... [Contractor's account number]. at ..... [name and address of the Contractor's Bank].

The maximum amount of this guarantee shall be progressively reduced by the amount of the advance payment repaid by the Contractor as indicated in copies of interim statements or payment certificates which shall be presented to us. This guarantee shall expire, at the latest, upon our receipt of a copy of the interim payment certificate indicating that eighty (80) percent of the Contract Price has been certified for payment, or on the ..... day of ..... 2, whichever is earlier. Consequently, any demand for payment under this guarantee must be received by us at this office on or before that date. The Guarantor agrees to a one-time extension of this guarantee for a period not to exceed [six months] [one year], in response to the Employer's written request for such extension, such request to be presented to the Guarantor before the expiry of the guarantee.

This guarantee is subject to the Uniform Rules for Demand Guarantees, ICC Publication No. 458.

..... [Seal of Bank and Signature(s)] .....

**Note:**

All italicized text is for guidance in preparing this demand guarantee and shall be deleted from the final document.

1 The Guarantor shall insert an amount representing the amount of the advance payment denominated either in the currency(ies) of the advance payment as specified in the Contract, or in a freely convertible currency acceptable to the Employer.

2 Insert the expected expiration date of the Time for Completion. The Employer should note that in the event of an extension of the time for completion of the Contract, the Employer would need to request an extension of this guarantee from the Guarantor. Such request must be in writing and must be made prior to the expiration date established in the guarantee.

