



ދިވެހިސަރުކާރުގެ ގެޒެޓް ގައި ބަޔާންކޮށްފައިވާ ދިވެހިސަރުކާރުގެ ގެޒެޓް ގައި
ބަޔާންކޮށްފައިވާ ދިވެހިސަރުކާރުގެ ގެޒެޓް ގައި ބަޔާންކޮށްފައިވާ ދިވެހިސަރުކާރުގެ ގެޒެޓް ގައި
ބަޔާންކޮށްފައިވާ ދިވެހިސަރުކާރުގެ ގެޒެޓް ގައި ބަޔާންކޮށްފައިވާ ދިވެހިސަރުކާރުގެ ގެޒެޓް ގައި

ބަޔާންކޮށްފައިވާ ދިވެހިސަރުކާރުގެ ގެޒެޓް ގައި

އިދާރާތަކާއި ބަޔާންކޮށްފައިވާ (IUL)170-PR/170/2024/12

އިދާރާތަކާއި ބަޔާންކޮށްފައިވާ 12 ޖުލައި 2024

ބަޔާންކޮށްފައިވާ ދިވެހިސަރުކާރުގެ ގެޒެޓް ގައި ބަޔާންކޮށްފައިވާ ދިވެހިސަރުކާރުގެ ގެޒެޓް ގައި
ބަޔާންކޮށްފައިވާ ދިވެހިސަރުކާރުގެ ގެޒެޓް ގައި ބަޔާންކޮށްފައިވާ ދިވެހިސަރުކާރުގެ ގެޒެޓް ގައި





شؤون عمومية

شؤون عمومية

موضوع	تاريخ
1	<p>1. شؤون عمومية</p> <p>2. شؤون عمومية</p> <p>3. شؤون عمومية</p> <p>4. شؤون عمومية</p> <p>5. شؤون عمومية</p> <p>6. شؤون عمومية</p> <p>7. شؤون عمومية</p> <p>8. شؤون عمومية</p> <p>9. شؤون عمومية</p> <p>10. شؤون عمومية</p>





<p>3.3.2</p> <p>...</p>	<p>3.3.2</p>		
<p>3.3.3</p> <p>...</p>	<p>3.3.3</p>		
<p>4.1</p> <p>...</p>	<p>4.1</p>	<p>4.1</p>	<p>4.1</p>
<p>4.2</p> <p>...</p>	<p>4.2</p>	<p>4.2</p>	
<p>5.1</p> <p>...</p>	<p>5.1</p>	<p>5.1</p>	<p>5.1</p>
<p>6.1</p> <p>...</p>	<p>6.1</p>	<p>6.1</p>	<p>6.1</p>
			<p>(س) ...</p>
<p>7.1</p> <p>...</p>	<p>7.1</p>	<p>7.1</p>	<p>7.1</p>
<p>7.1.1</p> <p>...</p>	<p>7.1.1</p>		
<p>7.1.2</p> <p>...</p>	<p>7.1.2</p>		
<p>7.1.3</p> <p>...</p>	<p>7.1.3</p>		
<p>7.1.4</p> <p>...</p>	<p>7.1.4</p>		
<p>7.1.5</p> <p>...</p>	<p>7.1.5</p>		

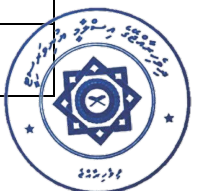



<p>... </p>			
<p>... </p>		<p>26:1</p>	<p>26. ځمکنازکونځ اړخو ځي ځي ځي نزلونو</p>





ސަފްހާ 3

އިތުރު ސަފްހާތަކުގެ ނަންބަރުތައް ދަނީ ފަސޭހަ ގޮތެއްގައި ދެކުނެވެ.

<p>"މަސަލާހުގެ ފަންނު" ނަމަށް ބުނެފައި ހުންނަ ފަންނުގެ ނަންބަރު 27.1 ބަނޑު ދަނީ ފަސޭހަ ގޮތެއްގައި.</p>	27.1	27. ބަނޑު ދަނީ
<p>"މަސަލާހުގެ ފަންނު" ނަމަށް ބުނެފައި ހުންނަ ފަންނުގެ ނަންބަރު 27.2 ބަނޑު ދަނީ ފަސޭހަ ގޮތެއްގައި.</p>	27.2	
<p>"މަސަލާހުގެ ފަންނު" ނަމަށް ބުނެފައި ހުންނަ ފަންނުގެ ނަންބަރު 27.3 ބަނޑު ދަނީ ފަސޭހަ ގޮތެއްގައި.</p>	27.3	
<p>"މަސަލާހުގެ ފަންނު" ނަމަށް ބުނެފައި ހުންނަ ފަންނުގެ ނަންބަރު 27.4 ބަނޑު ދަނީ ފަސޭހަ ގޮތެއްގައި.</p>	27.4	
<p>"މަސަލާހުގެ ފަންނު" ނަމަށް ބުނެފައި ހުންނަ ފަންނުގެ ނަންބަރު 27.5 ބަނޑު ދަނީ ފަސޭހަ ގޮތެއްގައި.</p>	27.5	
<p>މަސަލާހުގެ ފަންނުގެ ނަންބަރު 28.1 ބަނޑު ދަނީ ފަސޭހަ ގޮތެއްގައި.</p>	28.1	28. ބަނޑު ދަނީ
<p>މަސަލާހުގެ ފަންނުގެ ނަންބަރު 28.2 ބަނޑު ދަނީ ފަސޭހަ ގޮތެއްގައި.</p>	28.2	
<p>މަސަލާހުގެ ފަންނުގެ ނަންބަރު 28.3 ބަނޑު ދަނީ ފަސޭހަ ގޮތެއްގައި.</p>	28.3	
<p>މަސަލާހުގެ ފަންނުގެ ނަންބަރު 29.1 ބަނޑު ދަނީ ފަސޭހަ ގޮތެއްގައި.</p>	29.1	29. ބަނޑު ދަނީ
<p>މަސަލާހުގެ ފަންނުގެ ނަންބަރު 30.3 ބަނޑު ދަނީ ފަސޭހަ ގޮތެއްގައި.</p>	30.3	30. ބަނޑު ދަނީ

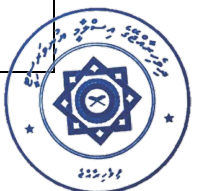



<p>33-1</p>	<p>33-1</p>	<p>33-1: ...</p>
<p>33-2</p>	<p>33-2</p>	<p>33-2</p>
<p>34-1</p>	<p>34-1</p>	<p>34: 34-1: ...</p>
<p>35-1</p>	<p>35-1</p>	<p>35: ...</p>
<p>36-1</p>	<p>36-1</p>	<p>36: ...</p>
<p>37-1</p>	<p>37-1</p>	<p>37: ...</p>
<p>38-1</p>	<p>38-1</p>	<p>38: ...</p>
<p>38-2</p>	<p>38-2</p>	<p>38-2</p>





1 2 3

1. 2. 3. 4. 5.

1. 2. 3. 4. 5.					
		1.1	1.2	1.3	1.4
		2.1	2.2		
3. 4. 5.					
150					
4. 5.					
4.1					
4.2					
5. 6. 7. 8.					
6. 7. 8.					
7. 8.					
8. 9.					
9. 10.					
10. 11.					
11. 12.					
12. 13.					
13. 14.					
14. 15.					
15. 16.					
16. 17.					
17. 18.					
18. 19.					
19. 20.					
20. 21.					
21. 22.					
22. 23.					
23. 24.					
24. 25.					
25. 26.					
26. 27.					
27. 28.					
28. 29.					
29. 30.					
30. 31.					
31. 32.					
32. 33.					
33. 34.					
34. 35.					
35. 36.					
36. 37.					
37. 38.					
38. 39.					
39. 40.					
40. 41.					
41. 42.					
42. 43.					
43. 44.					
44. 45.					
45. 46.					
46. 47.					
47. 48.					
48. 49.					
49. 50.					
50. 51.					
51. 52.					
52. 53.					
53. 54.					
54. 55.					
55. 56.					
56. 57.					
57. 58.					
58. 59.					
59. 60.					
60. 61.					
61. 62.					
62. 63.					
63. 64.					
64. 65.					
65. 66.					
66. 67.					
67. 68.					
68. 69.					
69. 70.					
70. 71.					
71. 72.					
72. 73.					
73. 74.					
74. 75.					
75. 76.					
76. 77.					
77. 78.					
78. 79.					
79. 80.					
80. 81.					
81. 82.					
82. 83.					
83. 84.					
84. 85.					
85. 86.					
86. 87.					
87. 88.					
88. 89.					
89. 90.					
90. 91.					
91. 92.					
92. 93.					
93. 94.					
94. 95.					
95. 96.					
96. 97.					
97. 98.					
98. 99.					
99. 100.					





2 2 2

2023
 (2023 - 2024)

6. 2023-2024				
	1.1	1.2	1.3	
	1.4	7. 2023-2024		
	2.1	2.2	8. 2023-2024	
2023-2024	2023-2024	2023-2024	2023-2024	2023-2024
	50			
9. 2023-2024				
	4.1	4.2	10. 2023-2024	

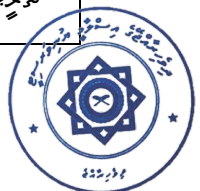



3 2 1

3 2 1
 3 2 1
 3 2 1

11. 3 2 1 3 2 1				
				1.1
				1.2
				1.3
				1.4
12. 3 2 1 3 2 1				
				2.1
				2.2
13. 3 2 1 3 2 1				
			50	
14. 3 2 1 3 2 1				
				4.1
				4.2
15. 3 2 1 3 2 1				





4 2 4

2016 2017 2018
 (2016 - 2018)

16. 2016 2017 2018				
				1.1
				1.2
				1.3
				1.4
17. 2016 2017 2018				
				2.1
				2.2
18. 2016 2017 2018				
				400
19. 2016 2017 2018				
				4.1
				4.2
20. 2016 2017 2018				





5 2 5

5 2 5
 5 2 5

21. 5 2 5 5 2 5				
				1.1 5 2 5
				1.2 5 2 5
				1.3 5 2 5
				1.4 5 2 5
22. 5 2 5 5 2 5				
				2.1 5 2 5
				2.2 5 2 5
23. 5 2 5 5 2 5				
5 2 5	5 2 5	5 2 5	5 2 5	5 2 5
			250	5 2 5
	5 2 5			
5 2 5 5 2 5				
5 2 5 5 2 5				
24. 5 2 5 5 2 5				
				4.1 5 2 5
				4.2 5 2 5
25. 5 2 5 5 2 5				
				5 2 5
				5 2 5
				5 2 5
				5 2 5

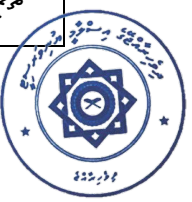



3 3 3

3 3 3 (-)

#	موضوع	عدد	نوع
1	تاريخ	50	
	نوع		
	نوع		
	نوع		

90 minutes

Notes:

-
-

Signature

Signature





4 3 2 1

400 (100 - 1000)

#	موضوع	الوقت	المرجع	التحضير
1	سورة	75		
2	جزء	150		
3	موضوع	100		
4	الموضوع	75		
التحضير:				
م.أ.ع.				
التحضير: م.أ.ع. الم.أ.ع.				

في كل سنة من سنة 2010 في 90 قورونو 2010.

في 2010 قورونو 2010.

م.أ.ع.

- 2010 في 2010 م.أ.ع. 2010 م.أ.ع. 2010 م.أ.ع. 2010 م.أ.ع.
- 2010 في 2010 م.أ.ع. 2010 م.أ.ع. 2010 م.أ.ع. 2010 م.أ.ع.
- 2010 في 2010 م.أ.ع. 2010 م.أ.ع. 2010 م.أ.ع. 2010 م.أ.ع.

2010 م.أ.ع.

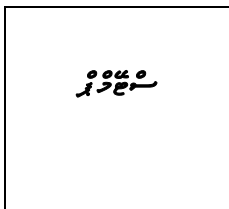



سنة ٢٠٢٠

الامتحان التحريري (المؤهل)

الامتحان التحريري في اللغة العربية:

الامتحان التحريري في اللغة العربية (المؤهل) - الامتحان التحريري (المؤهل)

السؤال: (سؤال من الأسئلة) - الامتحان التحريري (المؤهل)

الامتحان التحريري في اللغة العربية - الامتحان التحريري (المؤهل)

السؤال	الوقت
السؤال الأول	07
السؤال الثاني	12
السؤال الثالث	20
السؤال الرابع	08
السؤال الخامس	03
إجمالي	50

السؤال الأول: (سؤال من الأسئلة) - الامتحان التحريري (المؤهل)

الامتحان التحريري في اللغة العربية - الامتحان التحريري (المؤهل)

السؤال الثاني: (سؤال من الأسئلة) - الامتحان التحريري (المؤهل)

الامتحان التحريري في اللغة العربية - الامتحان التحريري (المؤهل)

السؤال الثالث: (سؤال من الأسئلة) - الامتحان التحريري (المؤهل)

السؤال الرابع: (سؤال من الأسئلة) - الامتحان التحريري (المؤهل)

السؤال الخامس: (سؤال من الأسئلة) - الامتحان التحريري (المؤهل)





**PHD
 STUDENTS
 GRADUATION GOWN
 SAMPLE**

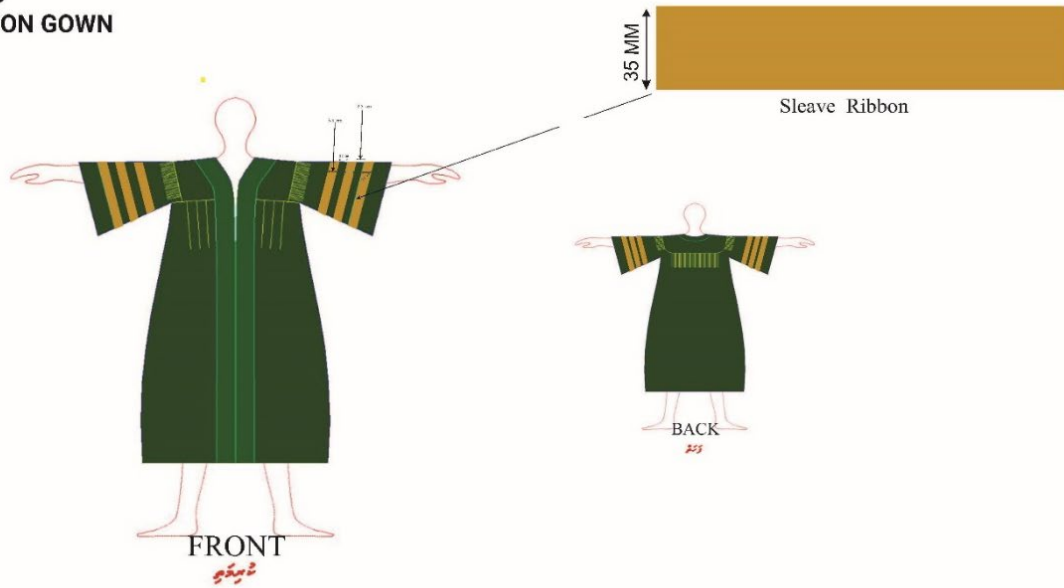

**PHD
 STUDENTS
 GRADUATION GOWN
 SAMPLE**

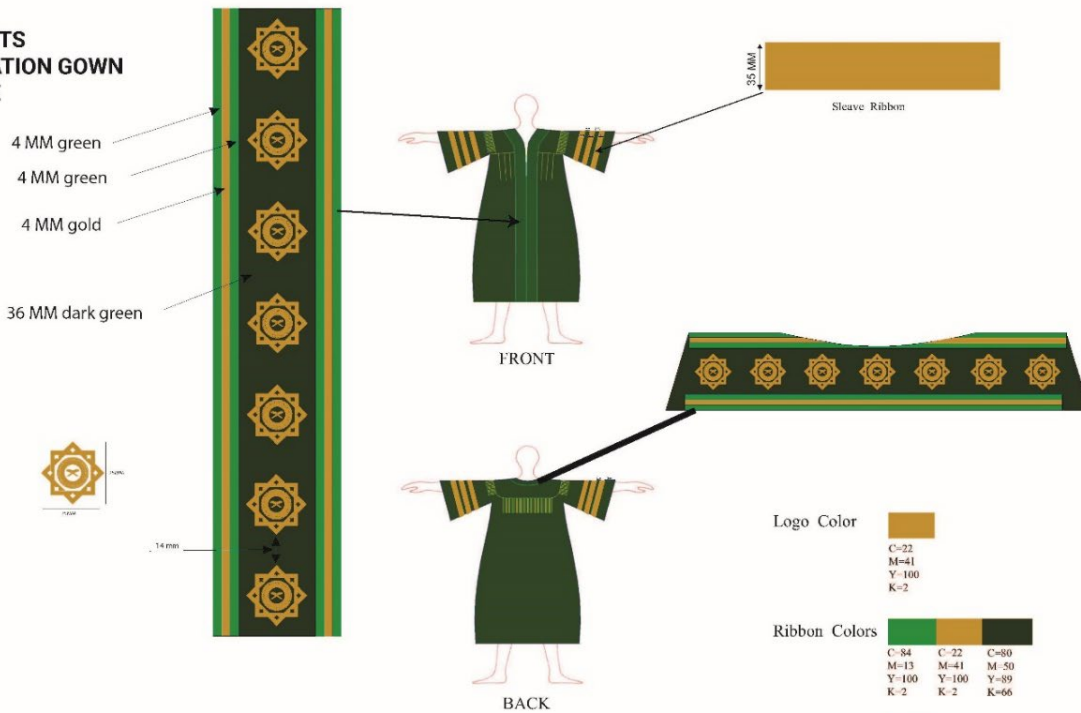

Logo Color

C=22
M=41
Y=100
K=2

Ribbon Colors

C=84	C=22	C=80
M=13	M=41	M=50
Y=100	Y=100	Y=89
K=2	K=2	K=66

Gown Color

C=80
M=50
Y=89
K=66

* The color of the gown should be dark green as in the ribbon





Logo Color



C=22
M=41
Y=100
K=2

Ribbon Colors



C=84	C=22	C=80
M=13	M=41	M=50
Y=100	Y=100	Y=89
K=2	K=2	K=66

Gown Color



C=80
M=50
Y=89
K=66

* The color of the gown should be dark green as in the ribbon





ސަފްހާ 5 3

މަދަރުސާތަކުގެ ނަންބަރު (ދަތުރު - ދަތުރު):

މިއަހަރުގެ ދަތުރުތަކުގެ ނަންބަރު

- ދަތުރު 1: ދަތުރު 1 (ދަތުރު 1 ގެ ނަންބަރު 1)
- ދަތުރު 2: ދަތުރު 2 (ދަތުރު 2 ގެ ނަންބަރު 2)
- ދަތުރު 3: ދަތުރު 3 (ދަތުރު 3 ގެ ނަންބަރު 3)
- ދަތުރު 4: ދަތުރު 4 (ދަތުރު 4 ގެ ނަންބަރު 4)
- ދަތުރު 5: ދަތުރު 5 (ދަތުރު 5 ގެ ނަންބަރު 5)
- ދަތުރު 6: ދަތުރު 6 (ދަތުރު 6 ގެ ނަންބަރު 6)
- ދަތުރު 7: ދަތުރު 7 (ދަތުރު 7 ގެ ނަންބަރު 7)
- ދަތުރު 8: ދަތުރު 8 (ދަތުރު 8 ގެ ނަންބަރު 8)
- ދަތުރު 9: ދަތުރު 9 (ދަތުރު 9 ގެ ނަންބަރު 9)
- ދަތުރު 10: ދަތުރު 10 (ދަތުރު 10 ގެ ނަންބަރު 10)

މަދަރުސާތަކުގެ ނަންބަރު (ދަތުރު)	
ދަތުރު	ނަންބަރު
50	ދަތުރު 1
50	ދަތުރު 2





PhD Students TAM

Size: Free size

Quantity: 50

Tassel color: Black with university logo

COLOR CODE: BLACK : #000000





سُئِلَ عَنْهُ 5 وَ 4

عَنْهُ وَبِهِ يَنْتَهِي / عَنْهُ / وَبِهِ يَنْتَهِي

سُئِلَ عَنْهُ 5 وَ 4 (عَنْهُ - وَبِهِ يَنْتَهِي)

عَنْهُ وَبِهِ يَنْتَهِي

- عَنْهُ وَبِهِ يَنْتَهِي : عَنْهُ وَبِهِ يَنْتَهِي (عَنْهُ وَبِهِ يَنْتَهِي)
- عَنْهُ وَبِهِ يَنْتَهِي : عَنْهُ وَبِهِ يَنْتَهِي (عَنْهُ وَبِهِ يَنْتَهِي)
- عَنْهُ وَبِهِ يَنْتَهِي : عَنْهُ وَبِهِ يَنْتَهِي (عَنْهُ وَبِهِ يَنْتَهِي)
- عَنْهُ وَبِهِ يَنْتَهِي : عَنْهُ وَبِهِ يَنْتَهِي (عَنْهُ وَبِهِ يَنْتَهِي)
- عَنْهُ وَبِهِ يَنْتَهِي : عَنْهُ وَبِهِ يَنْتَهِي (عَنْهُ وَبِهِ يَنْتَهِي)
- عَنْهُ وَبِهِ يَنْتَهِي : عَنْهُ وَبِهِ يَنْتَهِي (عَنْهُ وَبِهِ يَنْتَهِي)
- عَنْهُ وَبِهِ يَنْتَهِي : عَنْهُ وَبِهِ يَنْتَهِي (عَنْهُ وَبِهِ يَنْتَهِي)
- عَنْهُ وَبِهِ يَنْتَهِي : عَنْهُ وَبِهِ يَنْتَهِي (عَنْهُ وَبِهِ يَنْتَهِي)

سُئِلَ عَنْهُ 5 وَ 4 (عَنْهُ)	
عَنْهُ	عَنْهُ
75	عَنْهُ
150	عَنْهُ
100	عَنْهُ
75	عَنْهُ
400	عَنْهُ





IUM GRADUATION CAP

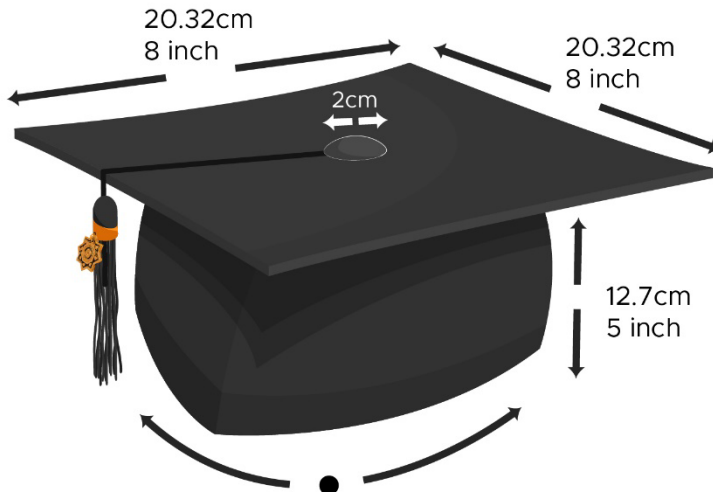

Cap Size Range:
 52cm-55cm /20in. - 21.5in. (S)
 56cm - 59cm /22in. - 23.5in.(M)
 60cm - 63cm /24in.-25in.(L)
 64cm - 67cm /25.1in.-26.3in.(XL)

COLOR CODE: BLACK : #000000

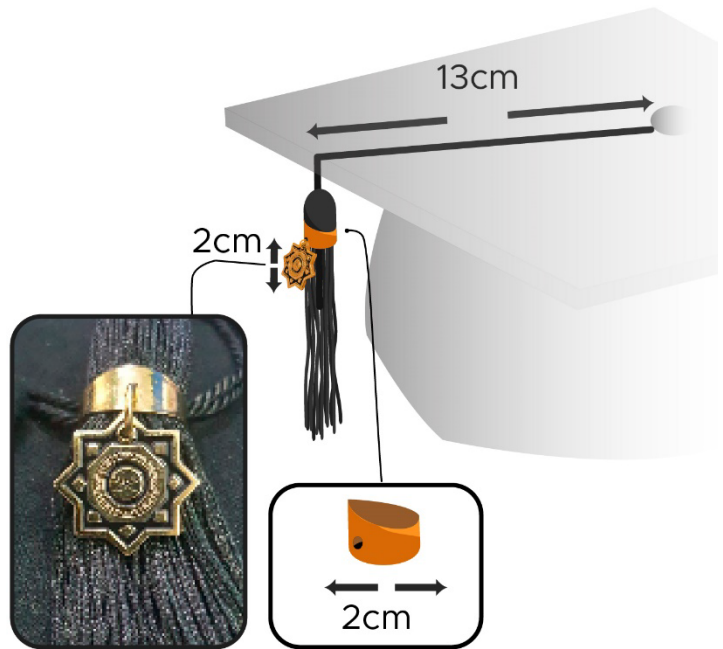



ސަލާމަތުގެ 5 5
މި ސަރަޖުގައި ދެވޭ ފަދަ ގަވާއިދުތަކެވެ.

މި ސަރަޖުގައި ދެވޭ ފަދަ ގަވާއިދުތަކެވެ (ކުލަގެ ފަދަ ގަވާއިދު)

މި ފަދަ ގަވާއިދުތަކެވެ:

- މި ފަދަ ގަވާއިދުތަކެވެ ތަޢާރުގެ ތެރޭގައި ހިމާރުކާލުމަކީ ހުއްދަ ނެތި ގަވާއިދުތައް ބަނޑުވަނީ ނުވަތަ ގަވާއިދުތައް ހުއްދަ ނެތި ގަވާއިދުތައް ބަނޑުވަނީ.
- މި ފަދަ ގަވާއިދުތަކެވެ ތަޢާރުގެ ތެރޭގައި ހިމާރުކާލުމަކީ ހުއްދަ ނެތި ގަވާއިދުތައް ބަނޑުވަނީ ނުވަތަ ގަވާއިދުތައް ބަނޑުވަނީ.
- މި ފަދަ ގަވާއިދުތަކެވެ ތަޢާރުގެ ތެރޭގައި ހިމާރުކާލުމަކީ ހުއްދަ ނެތި ގަވާއިދުތައް ބަނޑުވަނީ ނުވަތަ ގަވާއިދުތައް ބަނޑުވަނީ.

މި ފަދަ ގަވާއިދުތަކެވެ:

Kulliyah / Centre	Color	Code	Code		Quantity	
			CMYK	RGB		
Kulliyah of Education	Turquoise	ދުވަނު	62	0 0 31 0	48 213 200	250



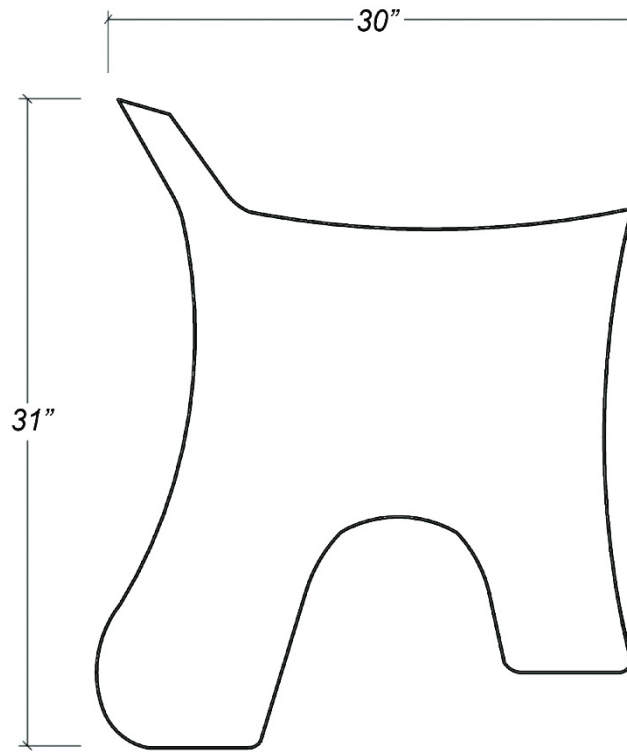

٥٣
٤٧

