

Incinerator shed

K.Maafushi

12 June 2019

MWSC

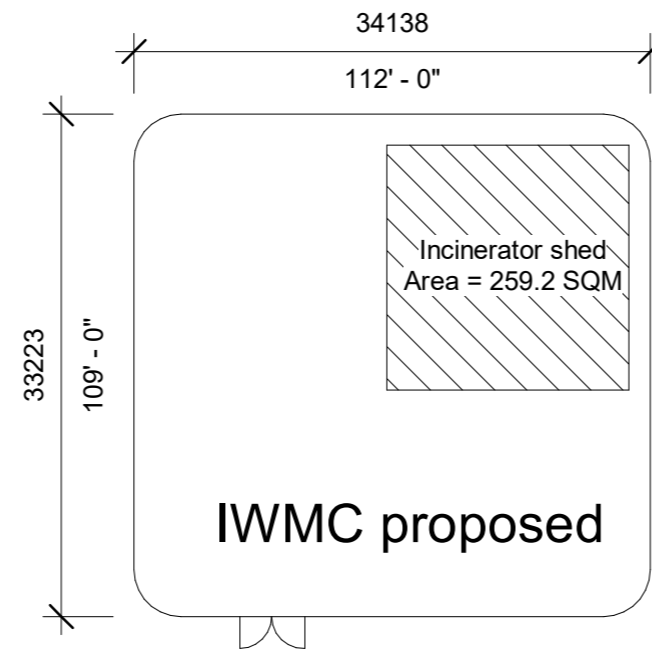

Futsal ground



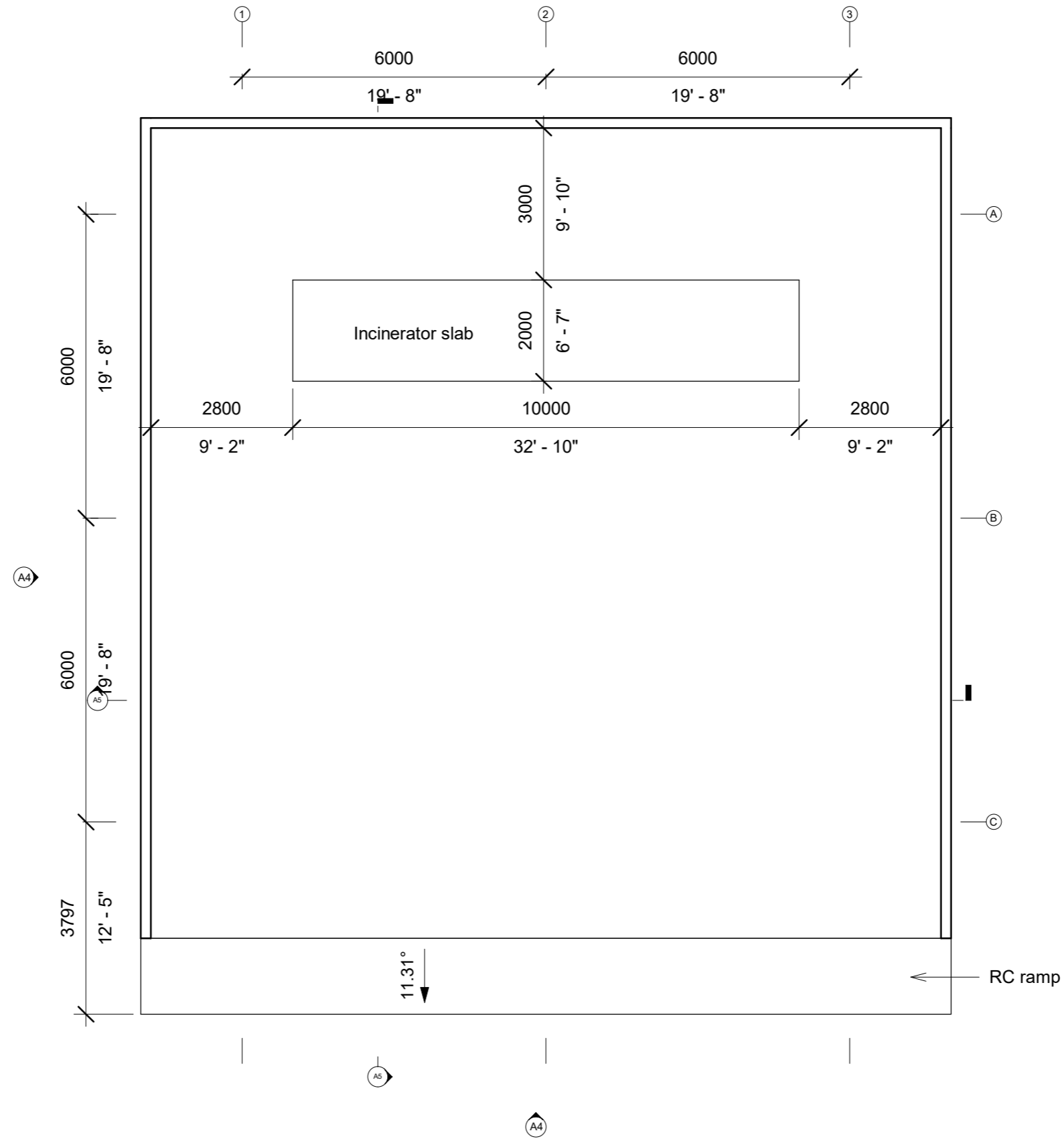

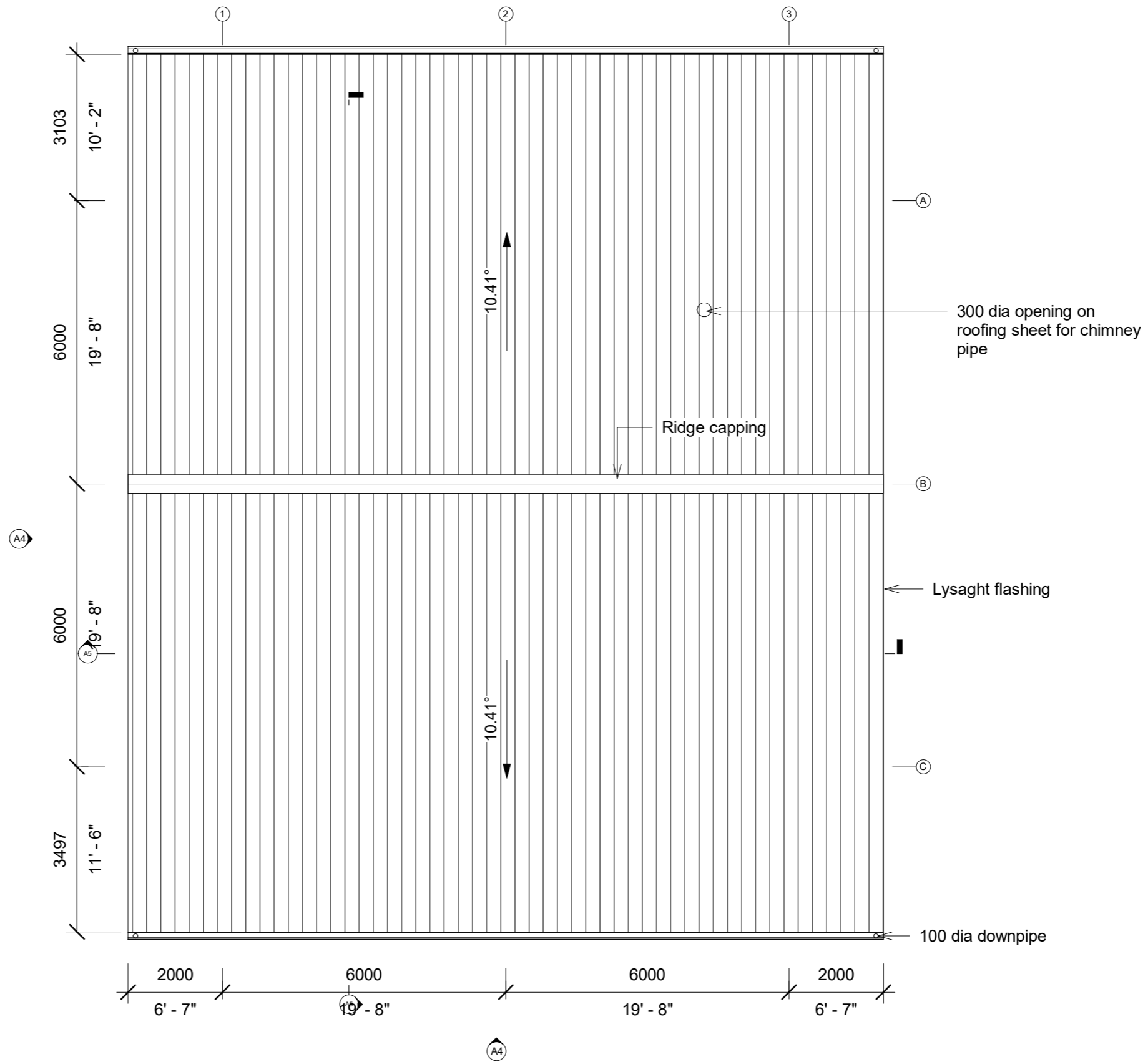

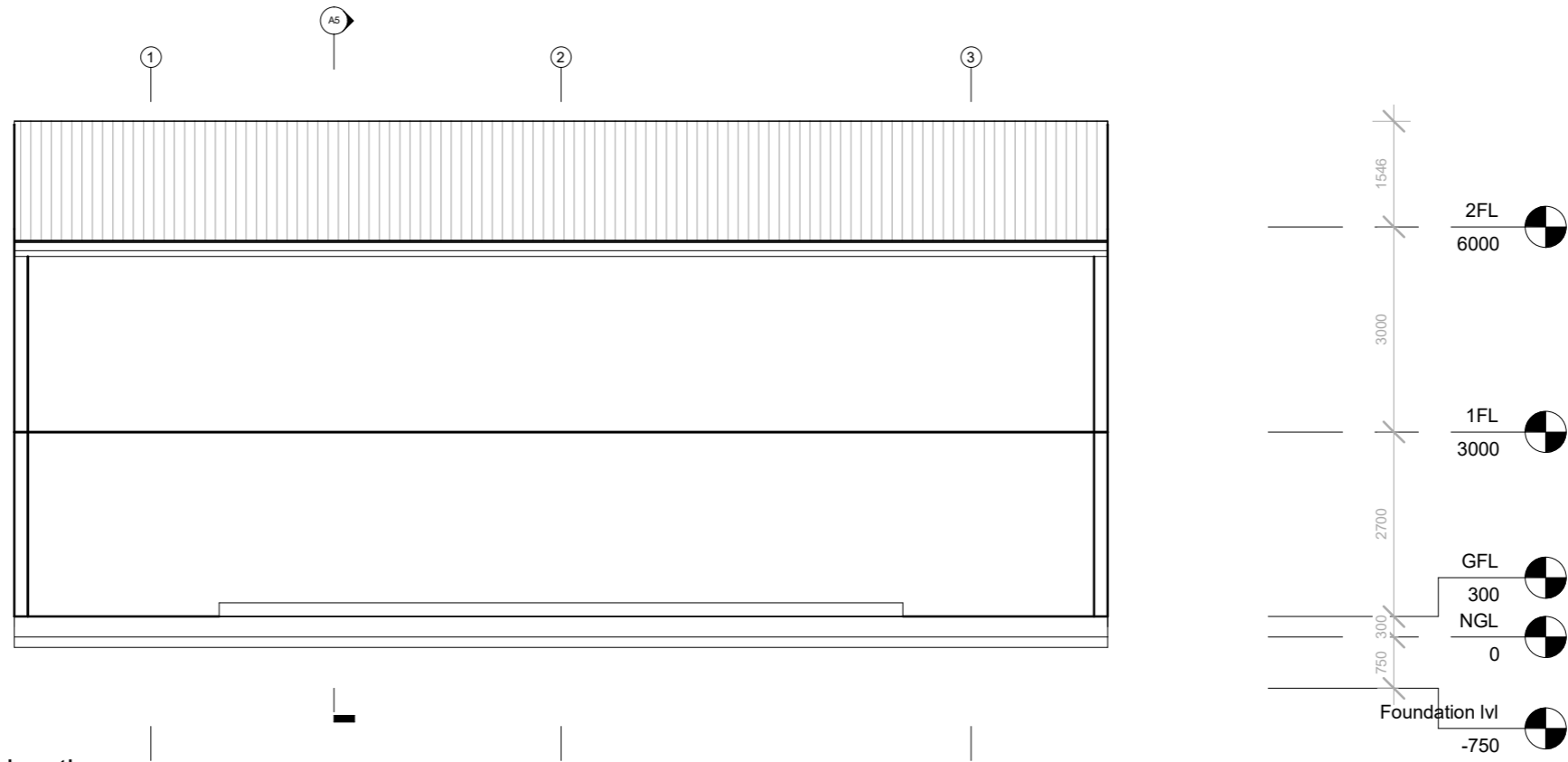

1 Front elevation
1 : 100

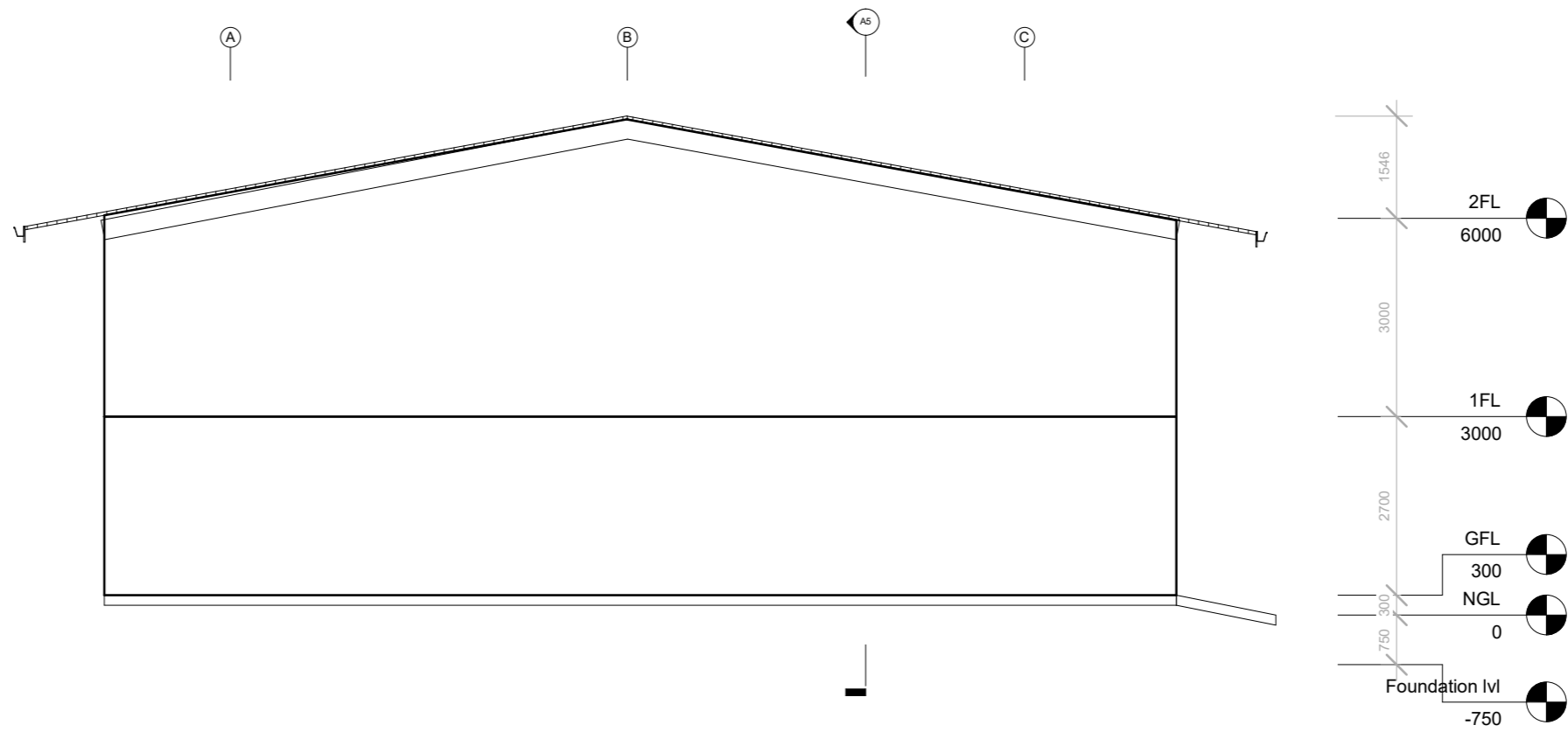

2 Side elevation
1 : 100



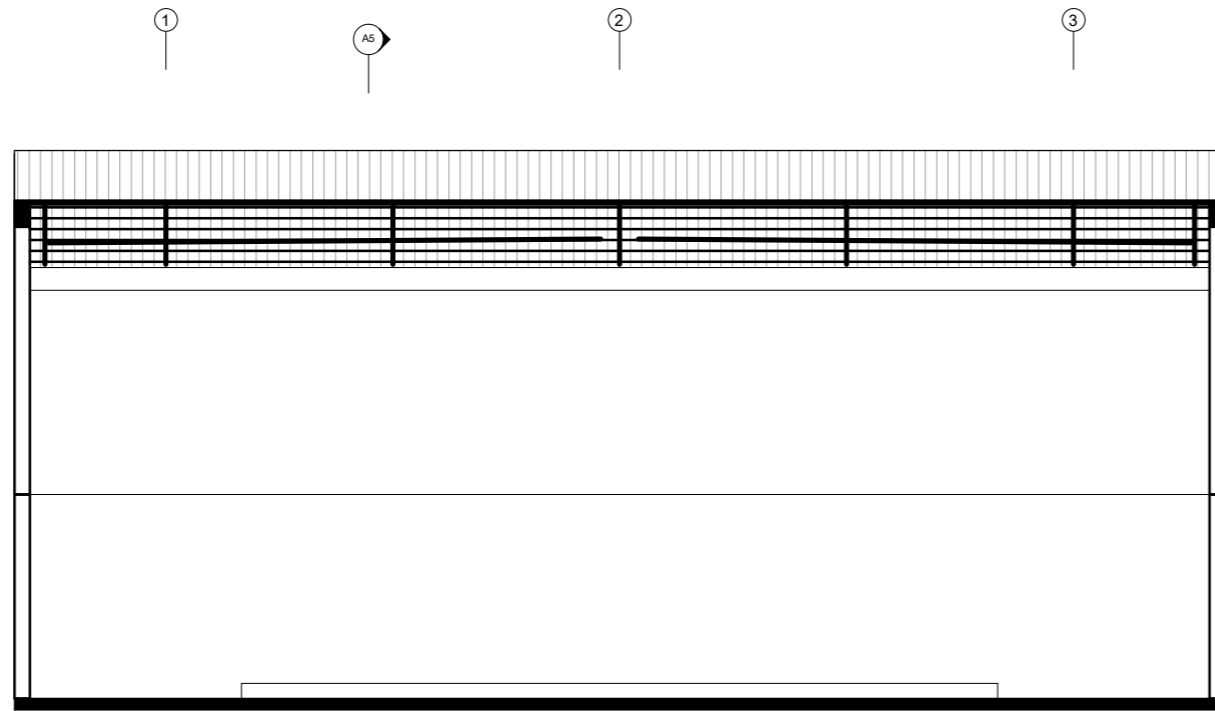

① Section X
1 : 100

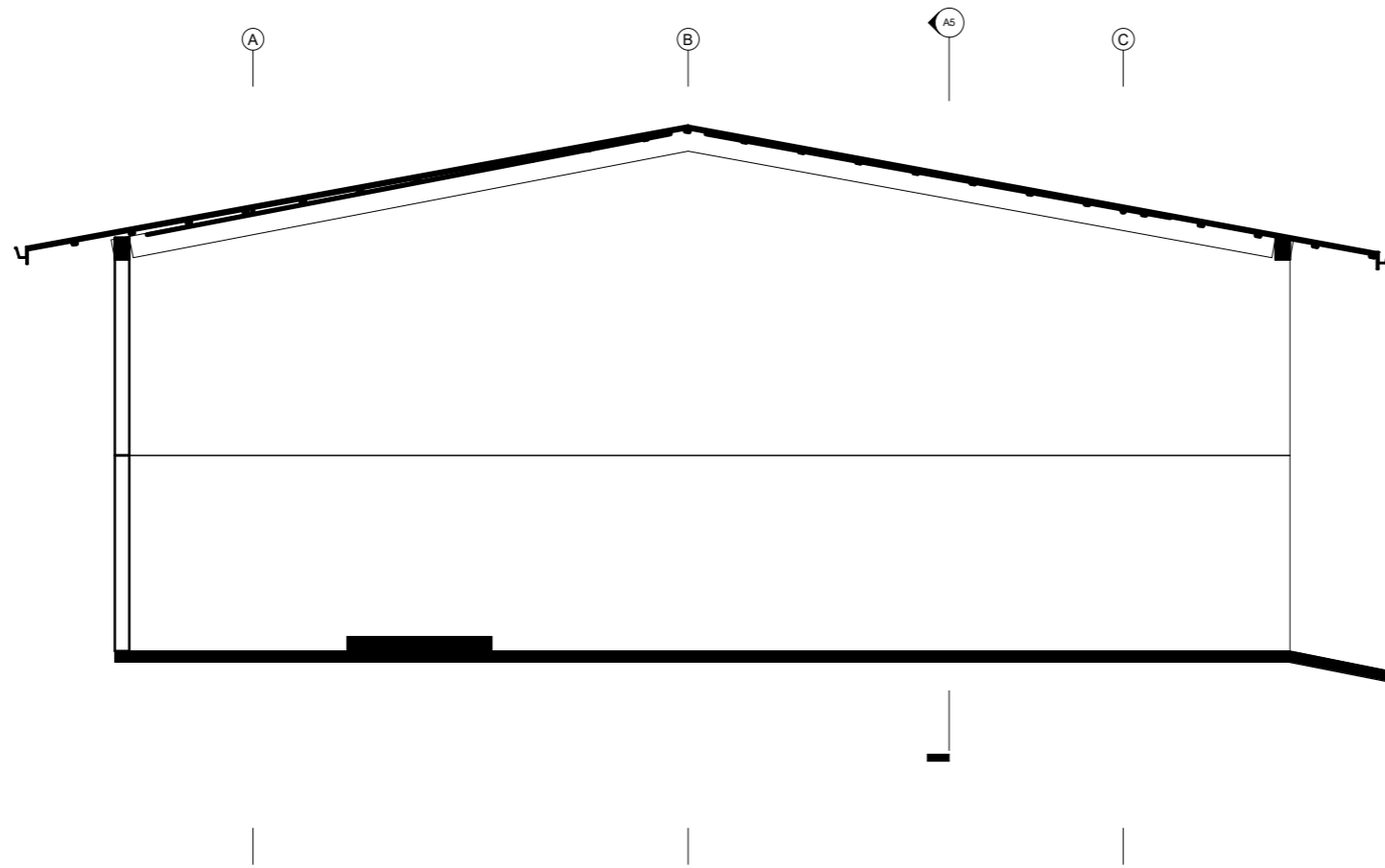
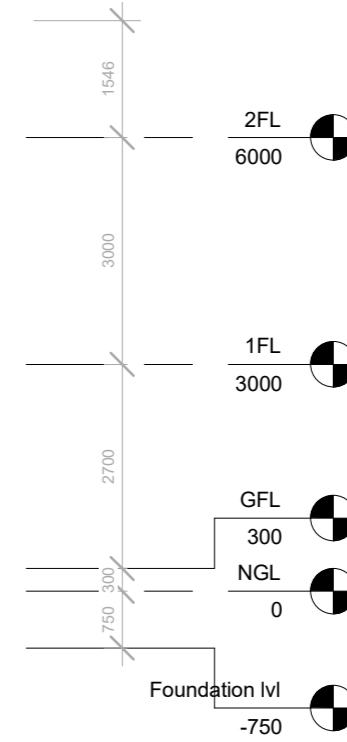

② Section Y
1 : 100

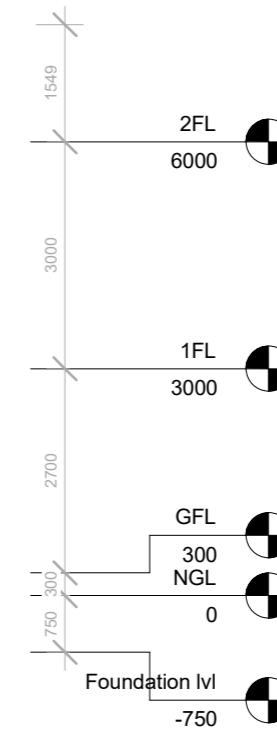

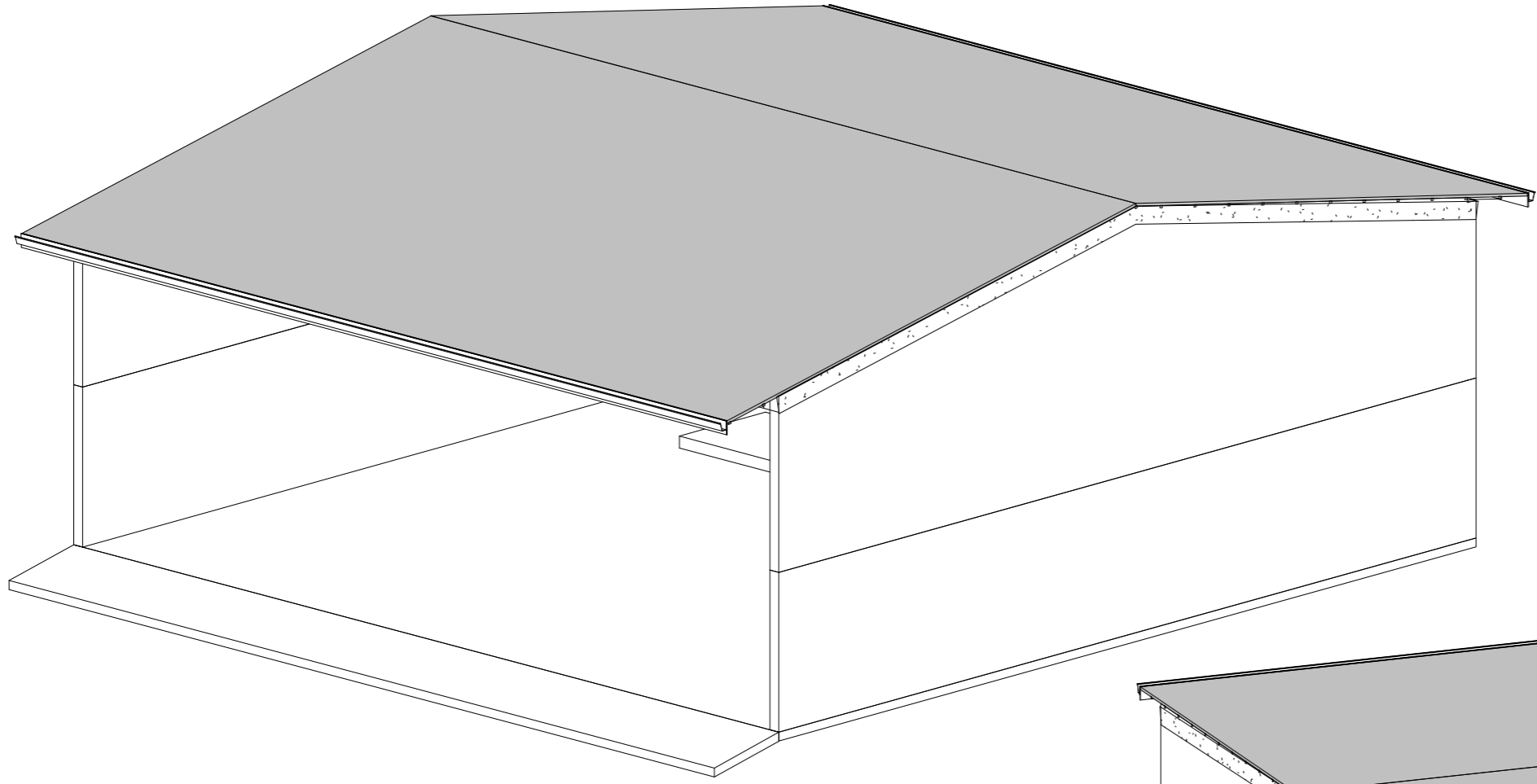

1 3D1

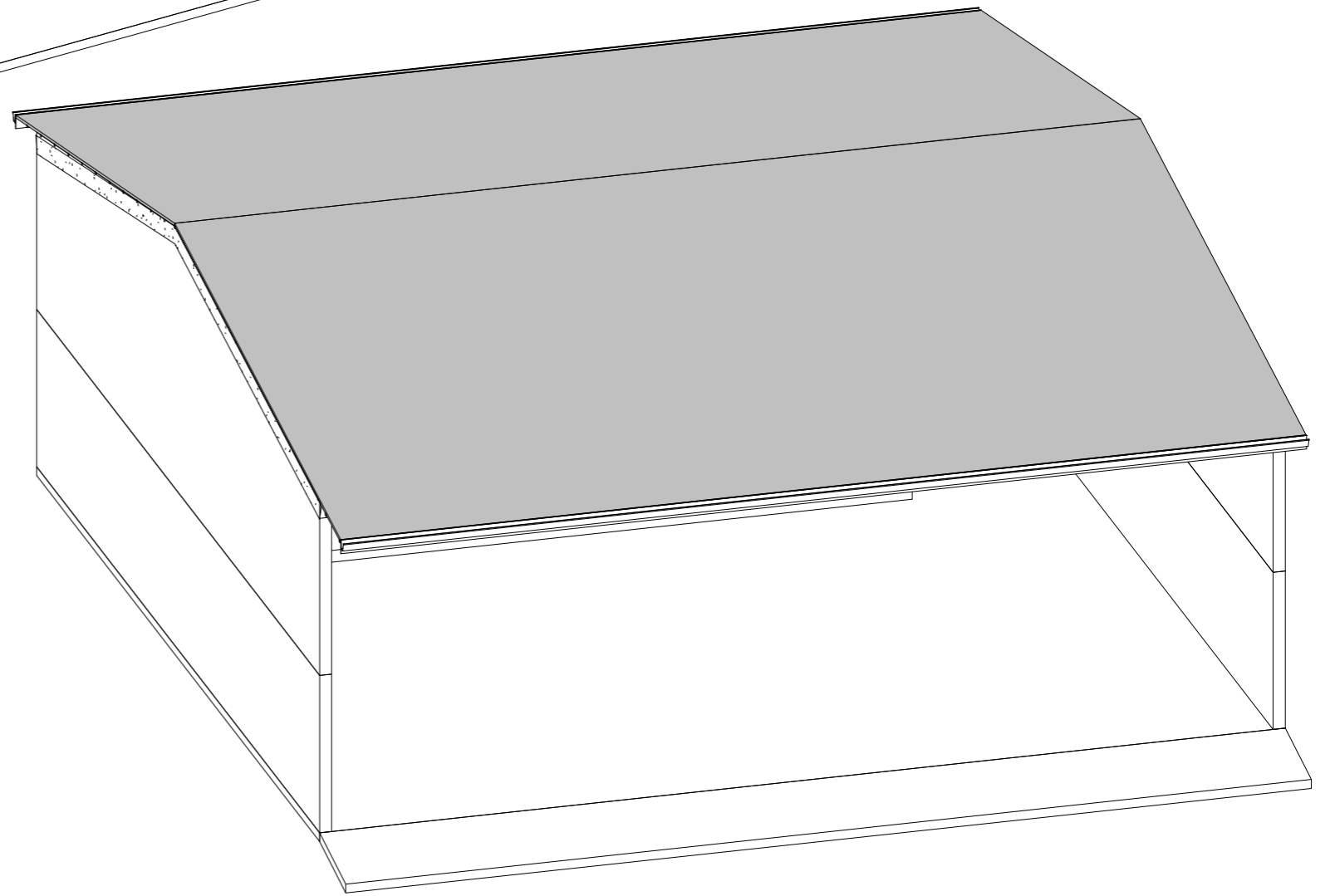

2 3D2



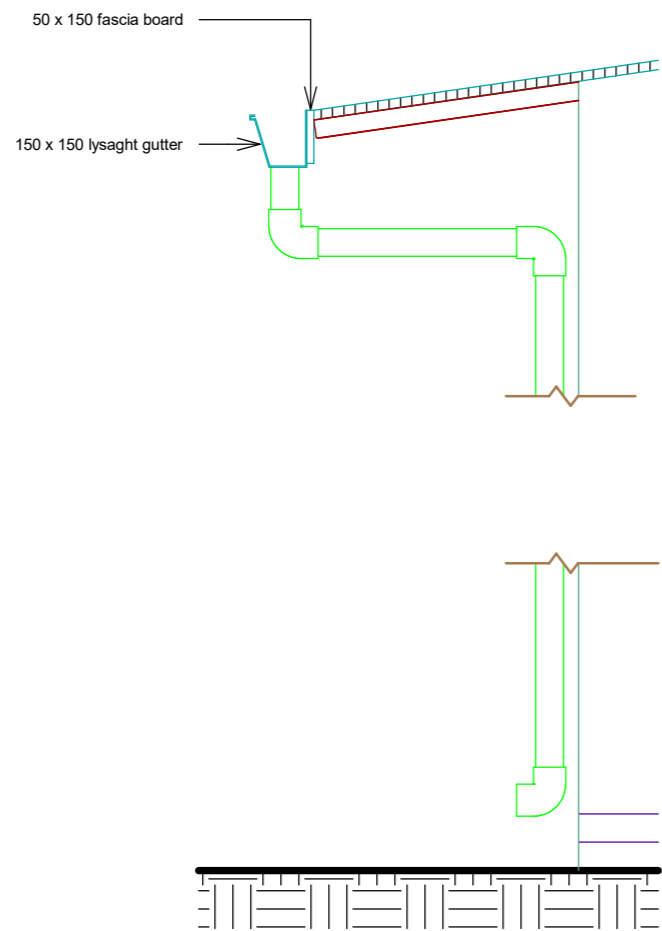



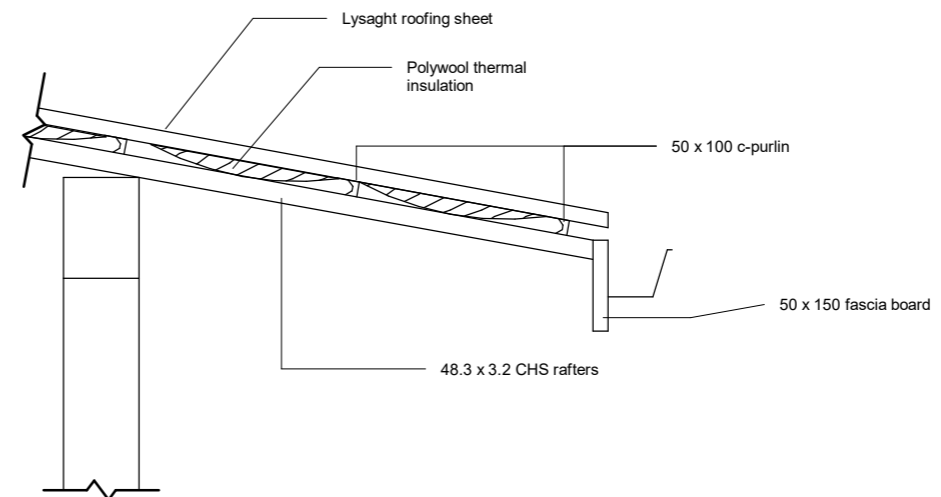















1 Downpipe detail
1 : 20















2 Roofing detail
1 : 20



-  Ceiling mounted indoor
-  Ceiling mounted outdoor
-  Ceiling recessed indoor
-  Wall mounted indoor
-  Wall mounted outdoor

-  Panel board
-  Distribution board
-  13A Single gang indoor socket
-  13A Single gang outdoor socket
-  15A Single gang indoor socket
-  15A Single gang outdoor socket
-  13A Double gang indoor socket
-  13A Double gang outdoor socket
-  15A Double gang indoor socket
-  15A Double gang outdoor socket
-  13A Triple gang indoor socket
-  13A Triple gang outdoor socket
-  13A Four gang indoor socket
-  13A Four gang outdoor socket

-  Single gang one way indoor switch
-  Single gang one way outdoor switch
-  Single gang two way indoor switch
-  Double gang one way indoor switch
-  Double gang one way outdoor switch
-  Double gang two way indoor switch
-  Triple gang one way indoor switch
-  Triple gang one way outdoor switch
-  Triple gang two way indoor switch
-  Four gang one way indoor switch
-  Four gang one way outdoor switch
-  Four gang two way indoor switch

 AC indoor unit

 AC outdoor unit

 Wall exhaust fan

 Wall mount fan

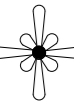
 Ceiling fan

 Fan controller

