

PVC COATED WIRE FENCE

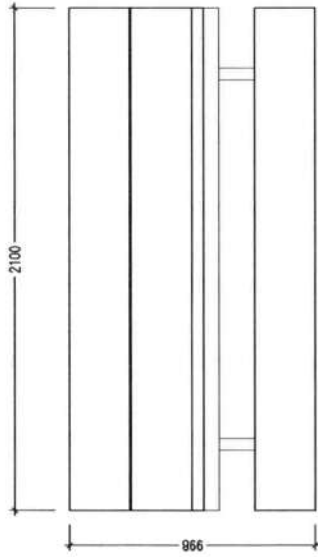

**8 Gauge, 75x75 mm
vinyl coated wire fence**

PORTABLE PLAYERS BENCH



PORTABLE PLAYERS BENCH- FLOOR PLAN
SCALE 1:20

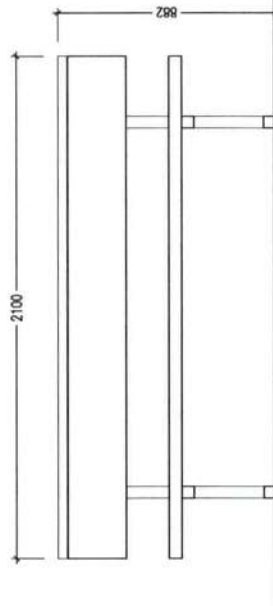

PORTABLE PLAYERS BENCH- SIDE ELEVATION
SCALE 1:20

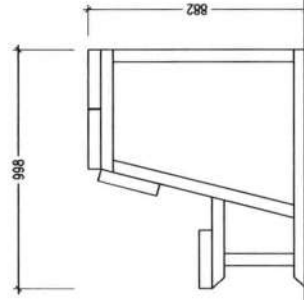

PORTABLE PLAYERS BENCH- SIDE ELEVATION
SCALE 1:20

System Information

Material: Aluminium
2100 mm , bench with single foot plank



VOLLEYBALL COURT TURF SPECIFICATIONS



VOLLEYBALL COURT TURF

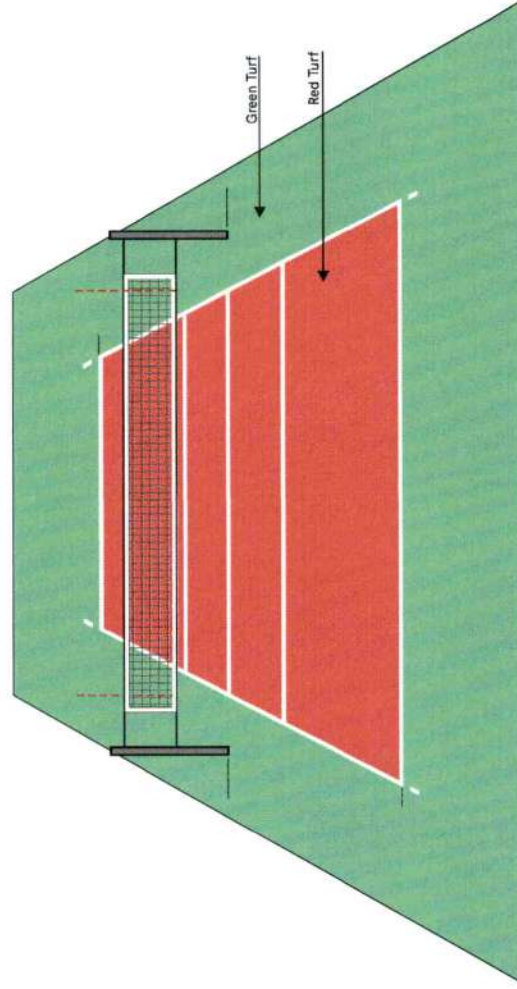

Volleyball court turf Specification

Pile Height	22mm
Dtex	9600
Stiches./m	310s/m (density:32,500/m2)
Colour	Red/Green
Gauge	3/8"
Grass yam	Fabrillated PE
Backing	PP+Net & SBR Latex
Rubber granules	07 kg/ sqm
Silica sand	09 kg/ sqm

VOLLEYBALL SYSTEM



Beach Volleyball Uprights

FIVB approved
 Beach use
 Internal bevel gear system for fine height adjustment
 Aluminum made
 Dust/Water/Rust proof design
 Under ground L300mm
 Inner post : \varnothing 76.3mm
 Outer post : \varnothing 85.0mm
 33kg/pair

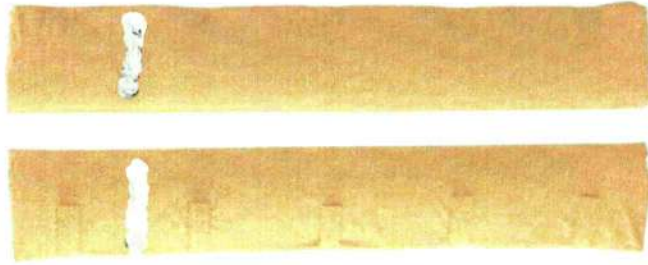

Safety Pads

FIVB approved
 Beach use
 Urethane foam covered with tarpaulins
 Easy attach/detach with Velcro tapes
 Dust/Water/Rust proof design
 H1700mm
 5kg/pair

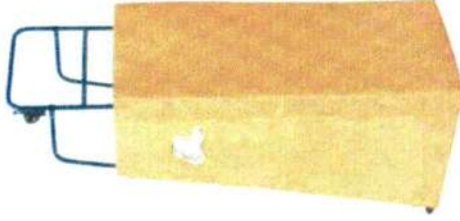

Beach Volleyball Referee Stand

FIVB approved
 Beach use
 Steel frame with padding
 Detachable handrail
 H2100 x W750 x D900mm
 Footplate height adjustable 930-1430mm
 57kg / unit

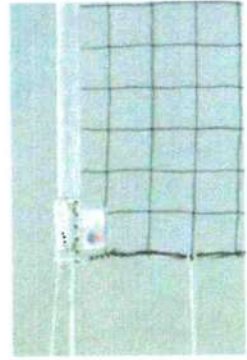

Official Volleyball Net

FIVB approved
 indoor use
 Polyethylene net with technora cable
 D100 x 9017/360
 H1000 x L6500mm
 100mm x 100mm square mesh