

FLOOR PLAN

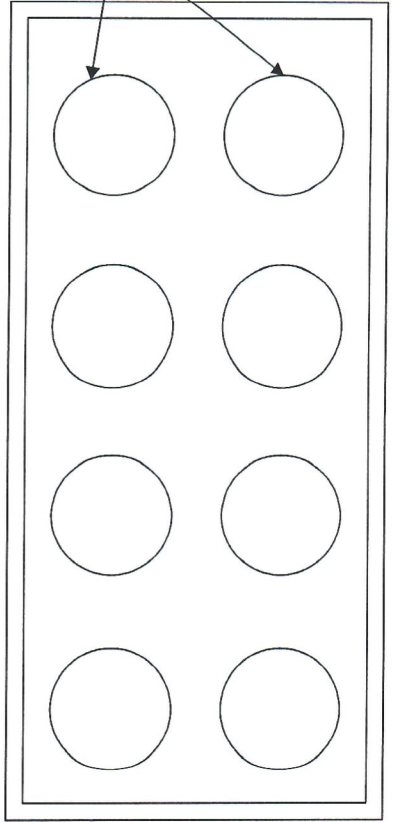

WATER TANKS

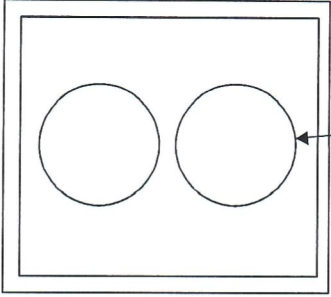
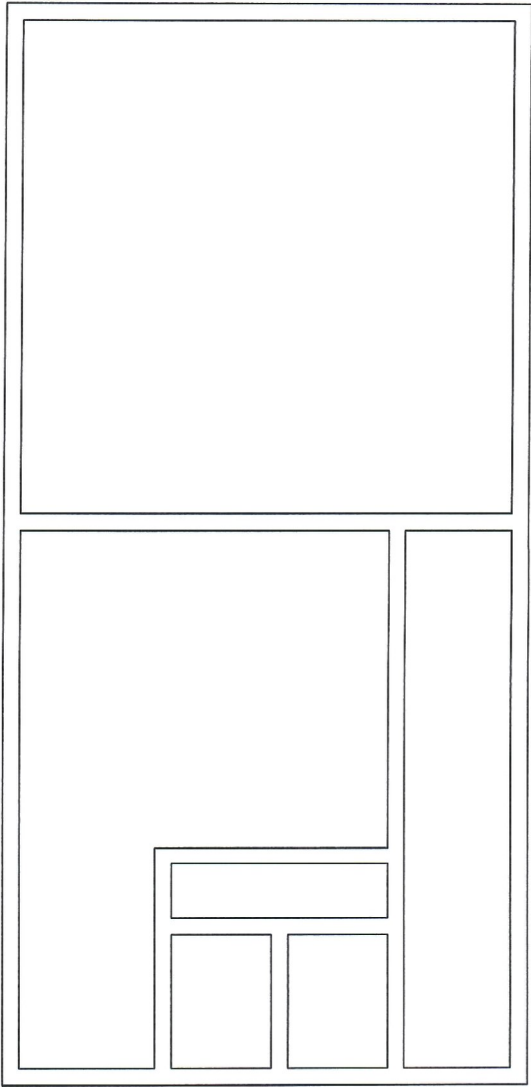
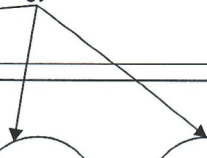

TOP VIEW PLAN

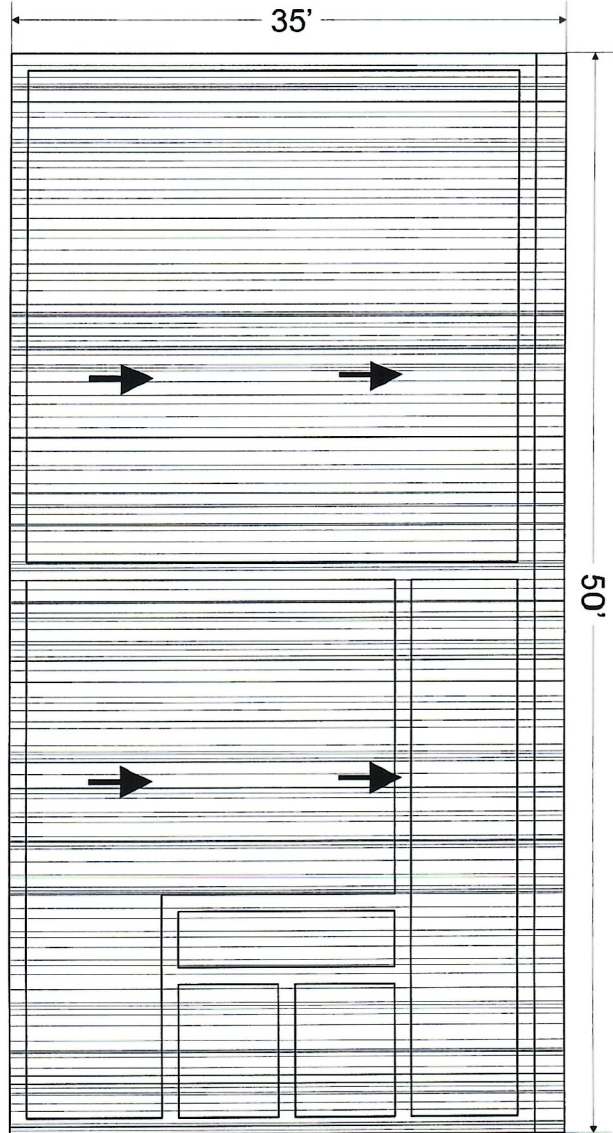
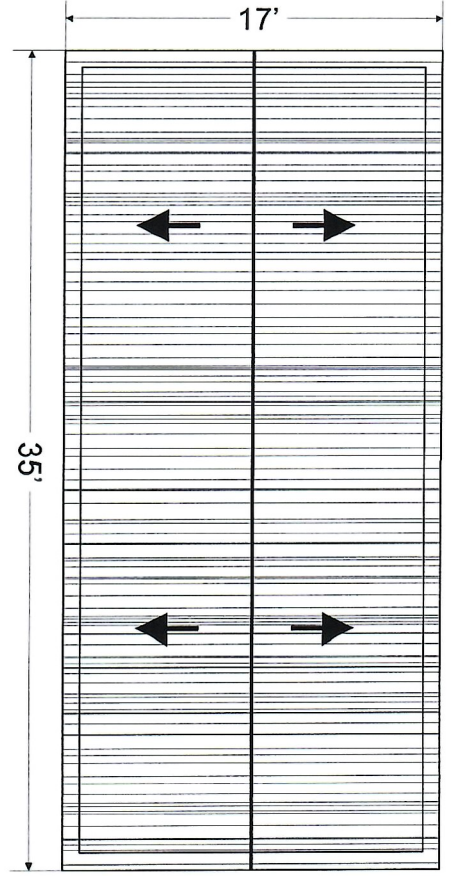
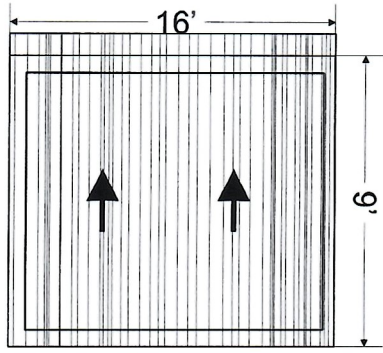

ROOF PLAN

ROOF PLAN



WATER INLET PLAN

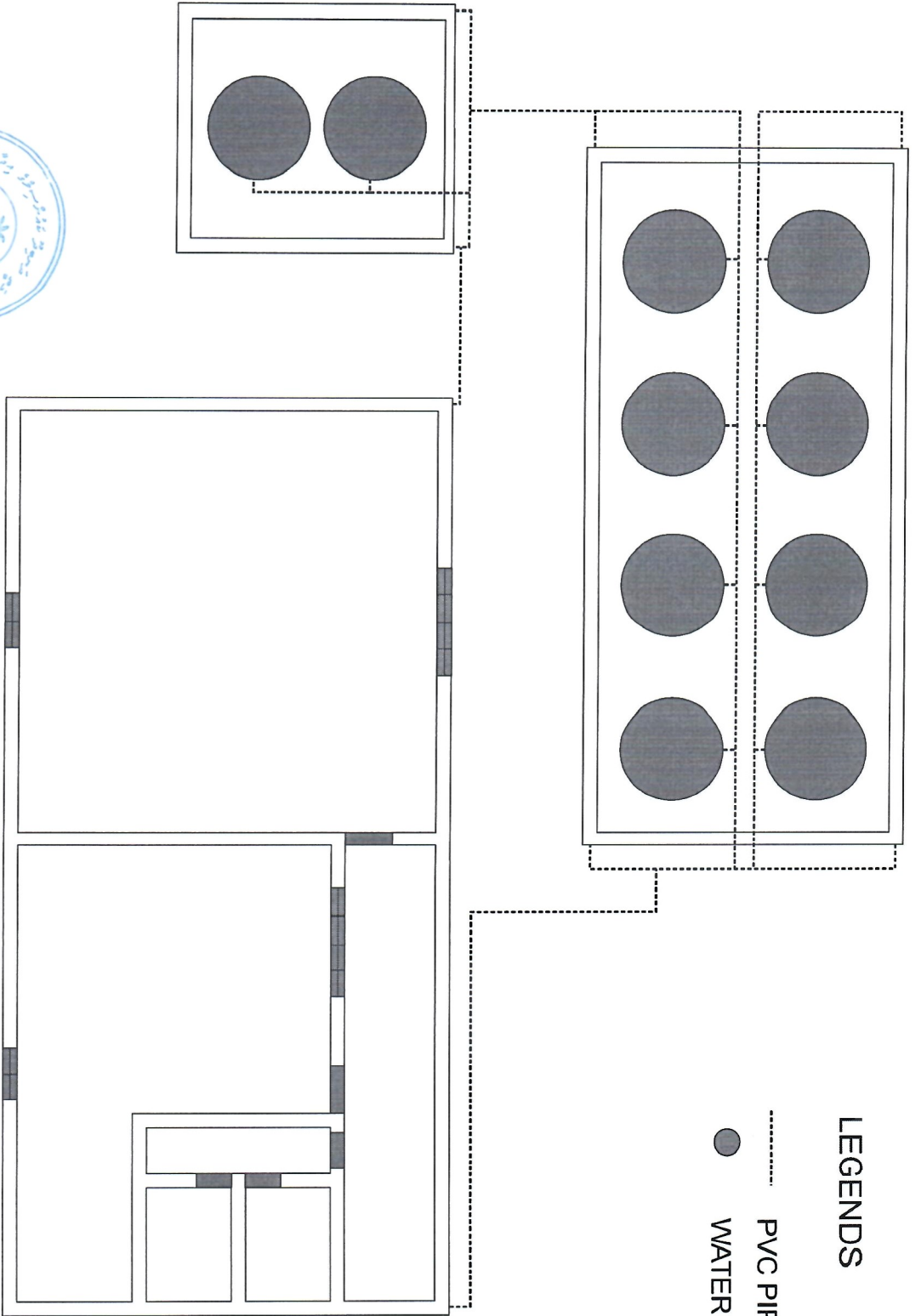

LEGENDS

- PVC PIPE LINE
- WATER TANKS

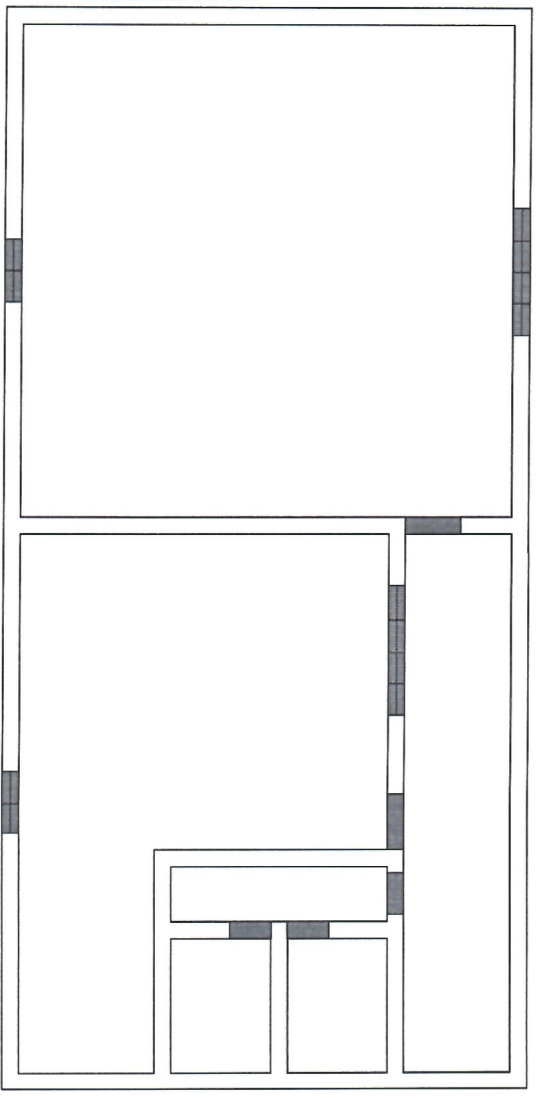
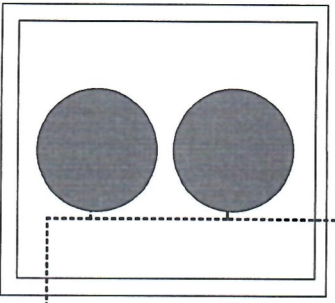
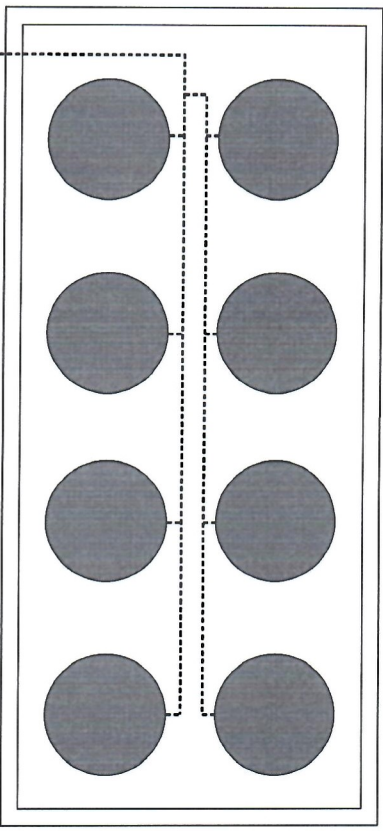

LEGENDS

- PVC PIPE LINE
- WATER TANKS
- 1 WATER TAPS



WATER OUTLET PLAN



SIDE ELEVATION

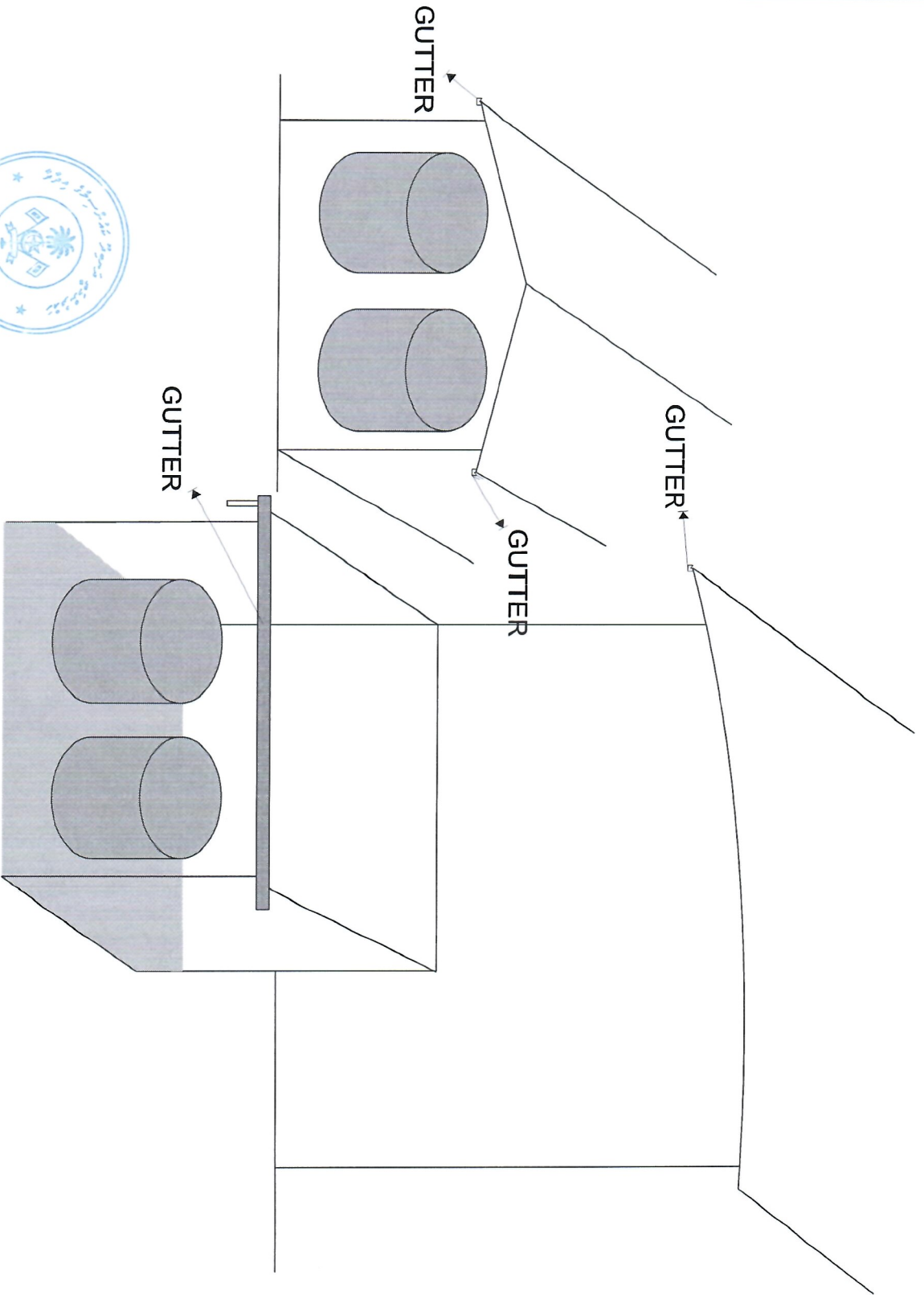

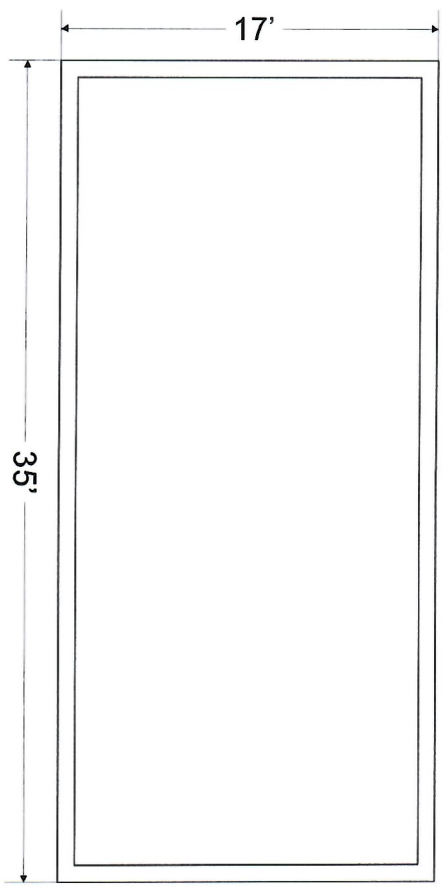

- LEGEND**
- ⊗ FAN
 - ⊞ M METER
 - ⊕ LIGHT
 - 4 GANG SWITCH
 - + 1 GANG SWITCH
 - ⚡ 2 GANG SOCKET

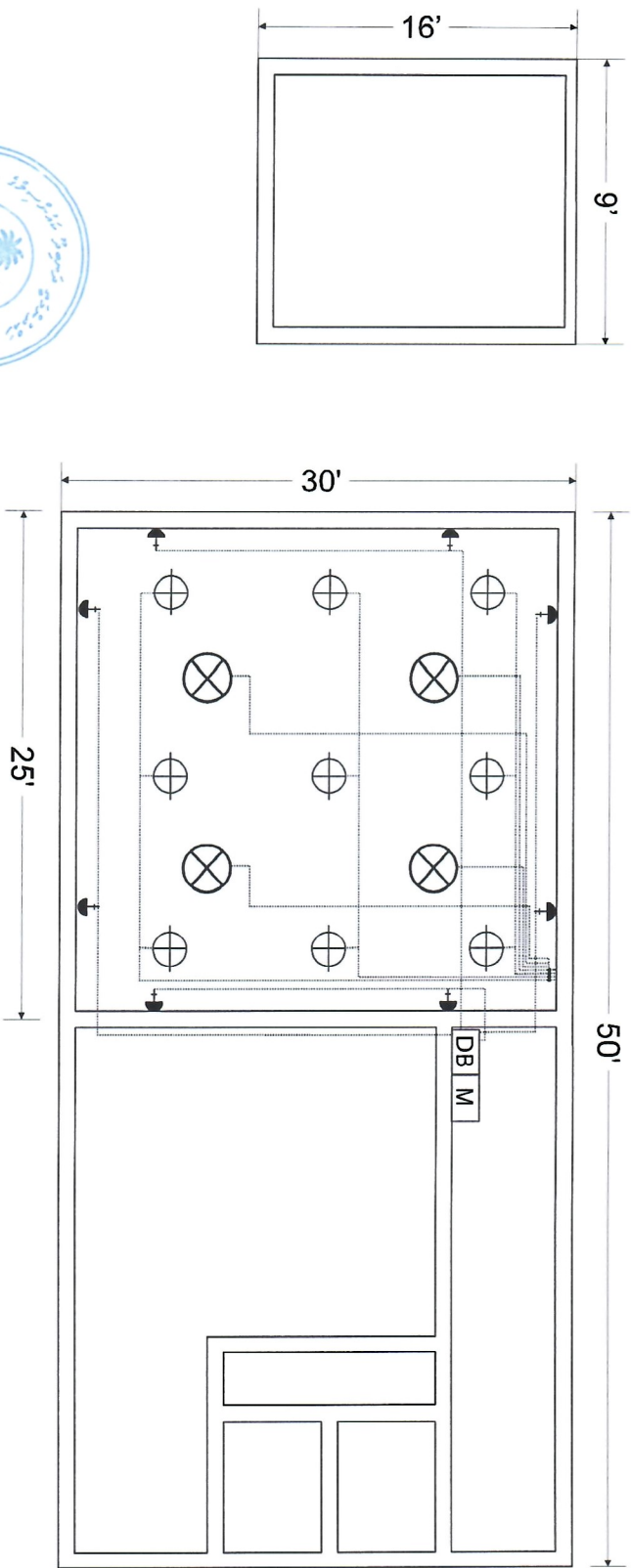

ELECTRICAL PLAN

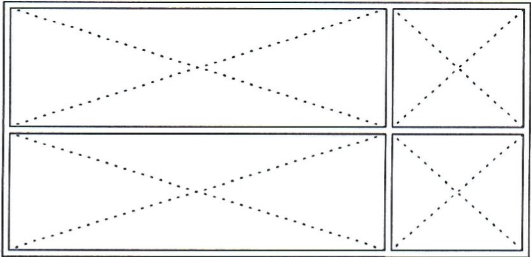

Aluminium Windows
(2 Pc . Fixed Glass)

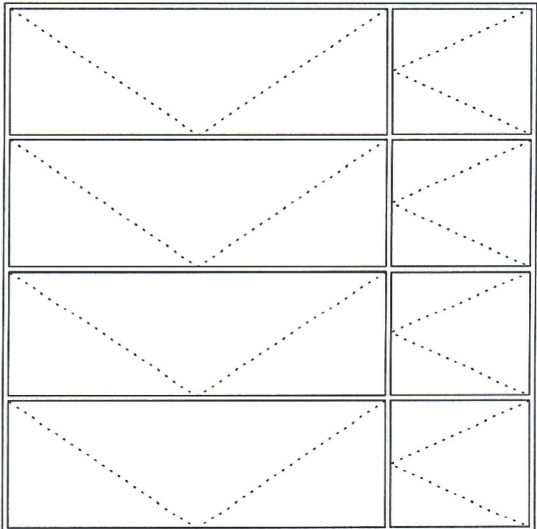

Aluminium Windows
(2 Pc . Operable)

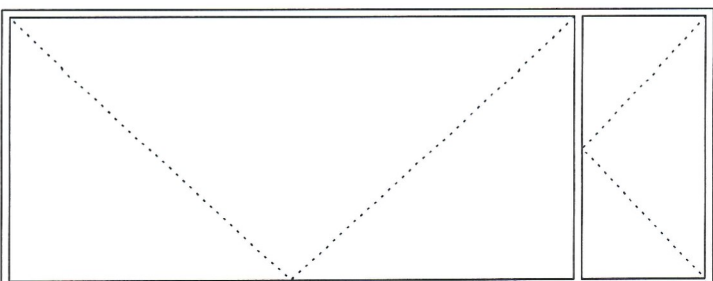

Timber Doors
(3 Pc . Operable)



DOORS AND WINDOWS PLAN