

# PROPOSED EXT. 2ROOM

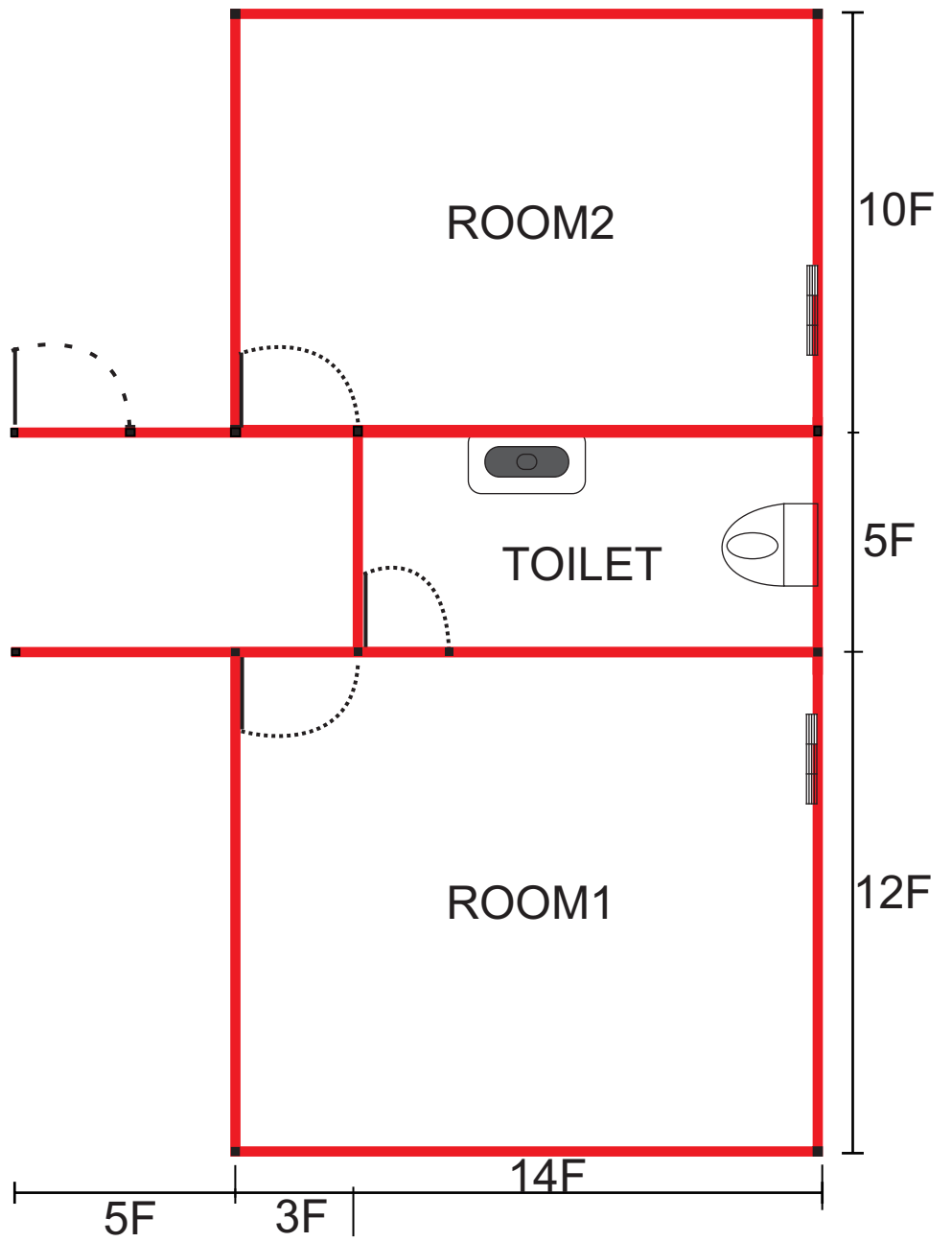

Floor Plan

# PROPOSED EXT. 2ROOM

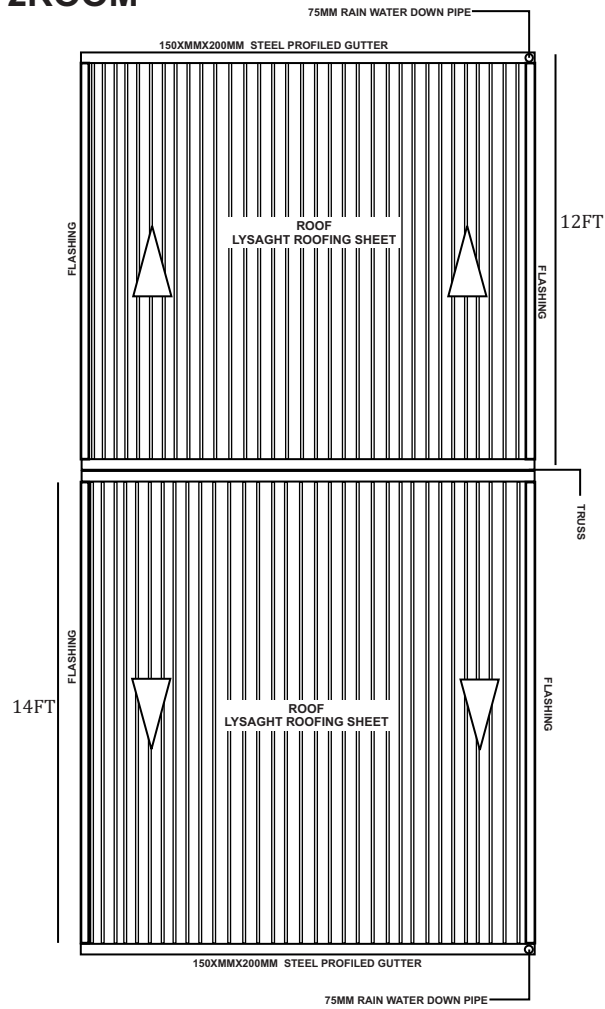

**Roof Plan**

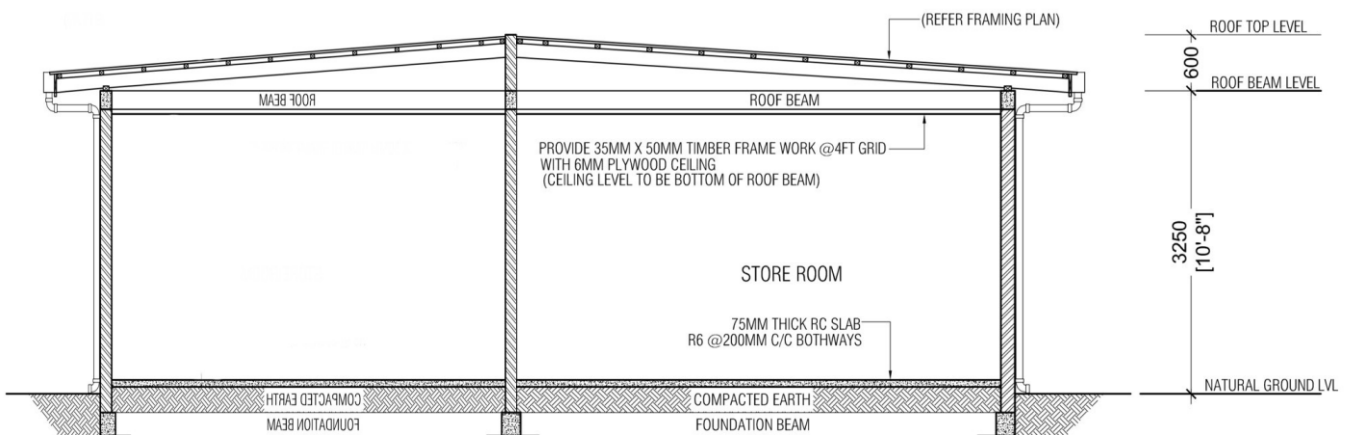

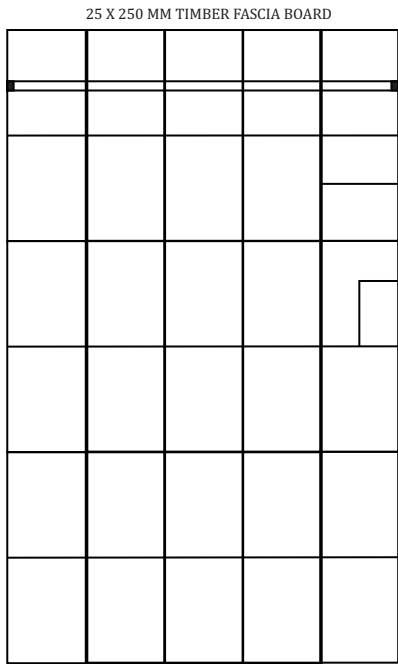

**ROOF FRAMING PLAN**

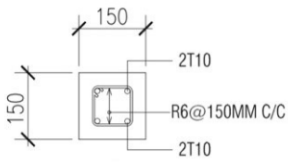

**COLUMN DETAILS**  
SCALE 1:10

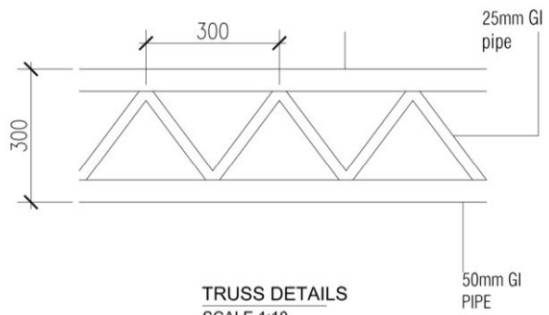

**TRUSS DETAILS**  
SCALE 1:10

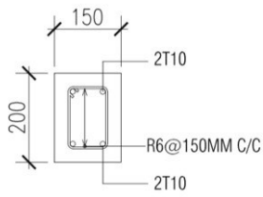

**FOUNDATION BEAM DETAILS**

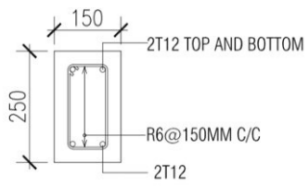

**ROOF BEAM DETAILS**

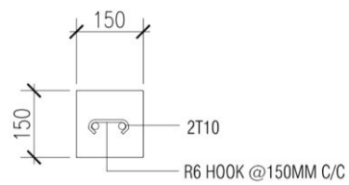

**LINTEL BEAM**

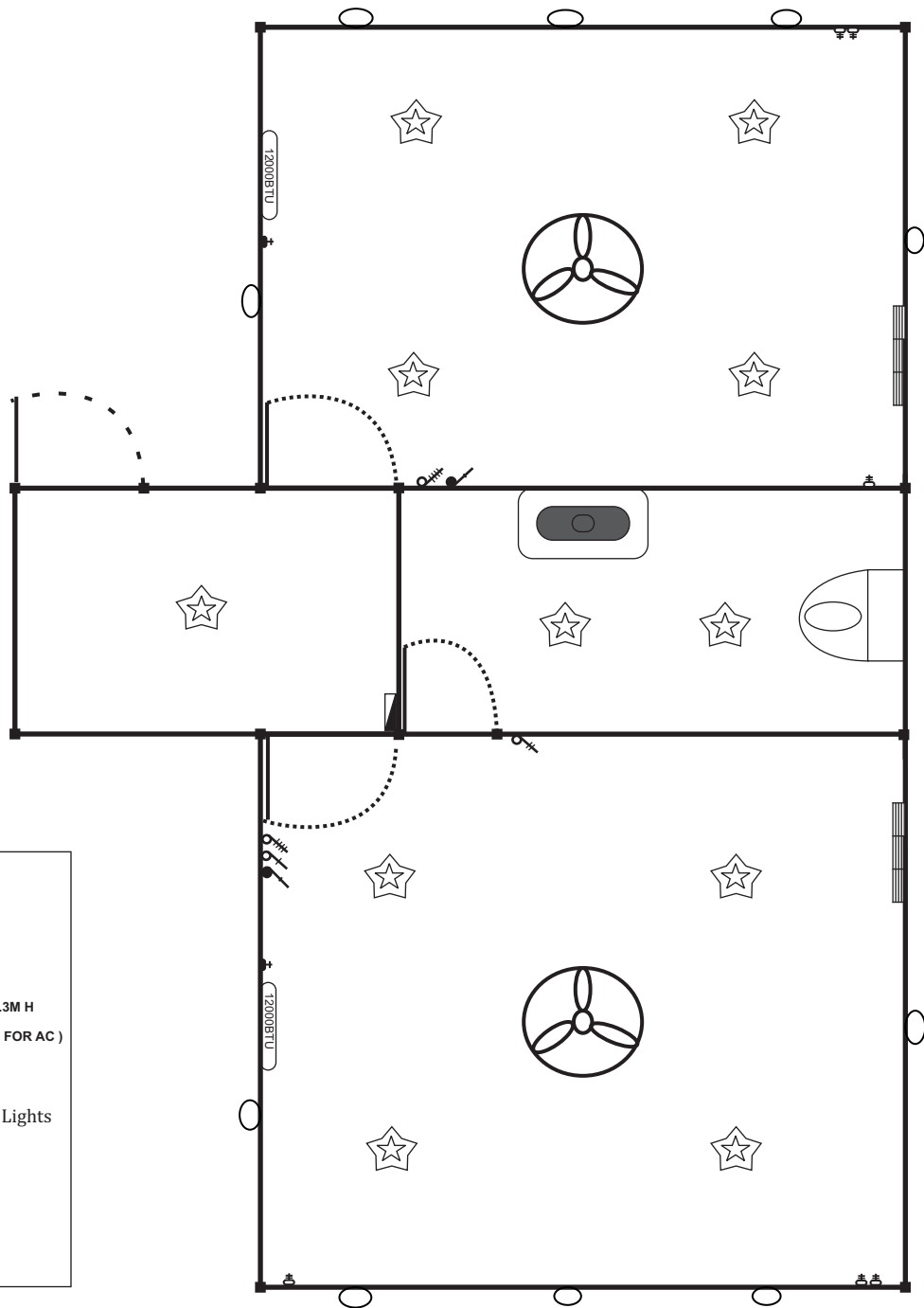

**LEGEND:**

SYMBOL	DESCRIPTION
	CEILING FAN
	ONE WAY SWITCH
	WALL SOCKET OUTLET ( DOUBLE GANG ) 0.3M H
	15A WALL SOCKET OUTLET ( SINGLE GANG FOR AC )
	FAN DIMMER
	DISTRIBUTION BOARD
	CEILING LIGHT
	WINDOW ( ALUMINUM )
	DOOR ( WOOD )
	DOOR ( ALUMINUM )
	OutDoor Lights

**NOTE:**  
ALL WIRING TO BE OF STELCO APPROVED STANDARDS

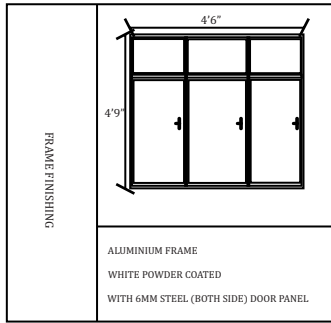

WINDOWS DETAILS

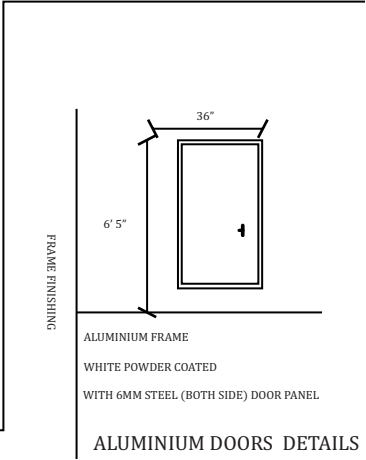

ALUMINIUM DOORS DETAILS

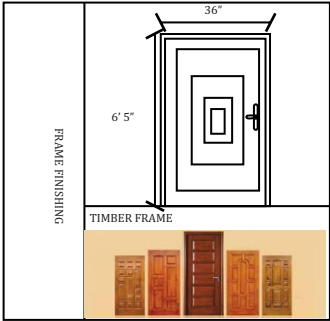

TIMBER DOORS DETAILS