

بِسْمِ اللّٰهِ الرَّحْمٰنِ الرَّحِیْمِ

Secretariat of The Hoarafushi Council  
HA· Hoarafushi  
Republic of Maldives



ދިވެހިރާއްޖޭގެ ޖުމްހޫރިއްޔާ ދެކޮޅަށް ސަލާމްތެރިކަން ދަންނަވާ ގޮތުގައި ސަރުކާރުގެ ފަރާތުން ދިވެހިރާއްޖޭގެ ޖުމްހޫރިއްޔާ ދެކޮޅަށް ސަލާމްތެރިކަން ދަންނަވާ ގޮތުގައި ސަރުކާރުގެ ފަރާތުން

ސަރުކާރުގެ ފަރާތުން ދިވެހިރާއްޖޭގެ ޖުމްހޫރިއްޔާ ދެކޮޅަށް ސަލާމްތެރިކަން ދަންނަވާ ގޮތުގައި ސަރުކާރުގެ ފަރާތުން

ސަރުކާރުގެ ފަރާތުން ދިވެހިރާއްޖޭގެ ޖުމްހޫރިއްޔާ ދެކޮޅަށް ސަލާމްތެރިކަން ދަންނަވާ ގޮތުގައި ސަރުކާރުގެ ފަރާތުން

ސަރުކާރުގެ ފަރާތުން ދިވެހިރާއްޖޭގެ ޖުމްހޫރިއްޔާ ދެކޮޅަށް ސަލާމްތެރިކަން ދަންނަވާ ގޮތުގައި ސަރުކާރުގެ ފަރާތުން

(IUL)247-CA/247/2022/89

ސަރުކާރުގެ ފަރާތުން ދިވެހިރާއްޖޭގެ ޖުމްހޫރިއްޔާ ދެކޮޅަށް ސަލާމްތެރިކަން ދަންނަވާ ގޮތުގައި ސަރުކާރުގެ ފަރާތުން

20 ސަލާމްތެރިކަން ދަންނަވާ ގޮތުގައި ސަރުކާރުގެ ފަރާތުން

ސަރުކާރުގެ ފަރާތުން ދިވެހިރާއްޖޭގެ ޖުމްހޫރިއްޔާ ދެކޮޅަށް ސަލާމްތެރިކަން ދަންނަވާ ގޮތުގައި ސަރުކާރުގެ ފަރާތުން

ސަރުކާރުގެ ފަރާތުން ދިވެހިރާއްޖޭގެ ޖުމްހޫރިއްޔާ ދެކޮޅަށް ސަލާމްތެރިކަން ދަންނަވާ ގޮތުގައި ސަރުކާރުގެ ފަރާތުން ދިވެހިރާއްޖޭގެ ޖުމްހޫރިއްޔާ ދެކޮޅަށް ސަލާމްތެރިކަން ދަންނަވާ ގޮތުގައި ސަރުކާރުގެ ފަރާތުން

بِسْمِ اللّٰهِ الرَّحْمٰنِ الرَّحِیْمِ

Secretariat of The Hoarafushi Council  
 HA· Hoarafushi  
 Republic of Maldives



ދިވެހިރާއްޖޭގެ ޖުމްހޫރިއްޔާ ގުޅިގެން ދިވެހިރާއްޖޭގެ ސަރުކާރުގެ ޖުމްހޫރިއްޔާ ގުޅިގެން  
 50  
 GOLDEN YEAR  
 -TOURISM 2022

ސަލާމަތުގެ ޖަލްސާ  
 ޖުމްހޫރިއްޔާ

ސަލާމަތުގެ ޖަލްސާ ގެ ޖުމްހޫރިއްޔާ	ސަރުކާރުގެ ޖުމްހޫރިއްޔާ
<p>މަސައްސަދާގެ ސަރުކާރުގެ ޖުމްހޫރިއްޔާ ގުޅިގެން ދިވެހިރާއްޖޭގެ ސަރުކާރުގެ ޖުމްހޫރިއްޔާ ގުޅިގެން                      (IUL)247-CA/247/2022/89 ސަރުކާރުގެ ޖުމްހޫރިއްޔާ                      2022 ސަލާމަތުގެ ޖަލްސާ 20</p>	1.1
<p>ސަލާމަތުގެ ޖަލްސާ ގެ ޖުމްހޫރިއްޔާ ގެ ޖުމްހޫރިއްޔާ ގުޅިގެން                      2022 ސަލާމަތުގެ ޖަލްސާ 20 ޖުމްހޫރިއްޔާ 26 ޖުމްހޫރިއްޔާ                      ސަރުކާރުގެ ޖުމްހޫރިއްޔާ ގުޅިގެން ދިވެހިރާއްޖޭގެ ސަރުކާރުގެ ޖުމްހޫރިއްޔާ ގުޅިގެން                      ޖުމްހޫރިއްޔާ: procurement@hoarafushi.gov.mv</p>	1.2
<p>ޖުމްހޫރިއްޔާ ގެ ޖުމްހޫރިއްޔާ ގެ ޖުމްހޫރިއްޔާ ގުޅިގެން                      2022 ސަލާމަތުގެ ޖަލްސާ 27 ޖުމްހޫރިއްޔާ 11:30 ޖުމްހޫރިއްޔާ</p>	1.3
<p>ޖުމްހޫރިއްޔާ ގެ ޖުމްހޫރިއްޔާ ގެ ޖުމްހޫރިއްޔާ ގުޅިގެން                      ދިވެހިރާއްޖޭގެ ސަރުކާރުގެ ޖުމްހޫރިއްޔާ ގުޅިގެން ދިވެހިރާއްޖޭގެ ސަރުކާރުގެ ޖުމްހޫރިއްޔާ ގުޅިގެން                      ޖުމްހޫރިއްޔާ ސަރުކާރުގެ ޖުމްހޫރިއްޔާ: 6500012                      ޖުމްހޫރިއްޔާ ސަރުކާރުގެ ޖުމްހޫރިއްޔާ: procurement@hoarafushi.gov.mv                      ޖުމްހޫރިއްޔާ: hassaan.hassan@hoarafushi.gov.mv</p>	1.3
<p>ޖުމްހޫރިއްޔާ ގެ ޖުމްހޫރިއްޔާ ގެ ޖުމްހޫރިއްޔާ ގުޅިގެން                      ޖުމްހޫރިއްޔާ ސަރުކާރުގެ ޖުމްހޫރިއްޔާ ގުޅިގެން (ޖުމްހޫރިއްޔާ 02 ޖުމްހޫރިއްޔާ ޖުމްހޫރިއްޔާ)</p>	2.0
<p>ސަލާމަތުގެ ޖަލްސާ ގެ ޖުމްހޫރިއްޔާ ގެ ޖުމްހޫރިއްޔާ ގުޅިގެން                      ސަރުކާރުގެ ޖުމްހޫރިއްޔާ ގުޅިގެން ދިވެހިރާއްޖޭގެ ސަރުކާރުގެ ޖުމްހޫރިއްޔާ ގުޅިގެން (ޖުމްހޫރިއްޔާ 03)                      ޖުމްހޫރިއްޔާ: 2022 ސަލާމަތުގެ ޖަލްސާ 03 (ޖުމްހޫރިއްޔާ)                      ޖުމްހޫރިއްޔާ: 11:30</p>	2.1









ނަންބަރު 2022-07-01

8.2 ޔަދުކުރެއްވުމަށް ޖަހާ ސަރުކާރުގެ ނަމުގައި ހިމެނޭ ފަރާތެއްގެ ނަމުގައި  
 ހިމެނޭ ފަރާތެއްގެ ނަމުގައި ހިމެނޭ ފަރާތެއްގެ ނަމުގައި

ހިމެނޭ ފަރާތެއްގެ ނަމުގައި ހިމެނޭ ފަރާތެއްގެ ނަމުގައި

ހިމެނޭ ފަރާތެއްގެ ނަމުގައި ހިމެނޭ ފަރާތެއްގެ ނަމުގައި

ހިމެނޭ ފަރާތެއްގެ ނަމުގައި ހިމެނޭ ފަރާތެއްގެ ނަމުގައި

ހިމެނޭ ފަރާތެއްގެ ނަމުގައި ހިމެނޭ ފަރާތެއްގެ ނަމުގައި

8.3 ޔަދުކުރެއްވުމަށް ޖަހާ ސަރުކާރުގެ ނަމުގައި ހިމެނޭ ފަރާތެއްގެ ނަމުގައި  
 ހިމެނޭ ފަރާތެއްގެ ނަމުގައި ހިމެނޭ ފަރާތެއްގެ ނަމުގައި

8.4 ޔަދުކުރެއްވުމަށް ޖަހާ ސަރުކާރުގެ ނަމުގައި ހިމެނޭ ފަރާތެއްގެ ނަމުގައި  
 ހިމެނޭ ފަރާތެއްގެ ނަމުގައި ހިމެނޭ ފަރާތެއްގެ ނަމުގައި

9 ސަރުކާރުގެ ނަމުގައި ހިމެނޭ ފަރާތެއްގެ ނަމުގައި ހިމެނޭ ފަރާތެއްގެ ނަމުގައި  
 ހިމެނޭ ފަރާތެއްގެ ނަމުގައި ހިމެނޭ ފަރާތެއްގެ ނަމުގައި

9.1 ޔަދުކުރެއްވުމަށް ޖަހާ ސަރުކާރުގެ ނަމުގައި ހިމެނޭ ފަރާތެއްގެ ނަމުގައި  
 ހިމެނޭ ފަރާތެއްގެ ނަމުގައި ހިމެނޭ ފަރާތެއްގެ ނަމުގައި

9.2 ޔަދުކުރެއްވުމަށް ޖަހާ ސަރުކާރުގެ ނަމުގައި ހިމެނޭ ފަރާތެއްގެ ނަމުގައި  
 ހިމެނޭ ފަރާތެއްގެ ނަމުގައި ހިމެނޭ ފަރާތެއްގެ ނަމުގައި

9.3 ޔަދުކުރެއްވުމަށް ޖަހާ ސަރުކާރުގެ ނަމުގައި ހިމެނޭ ފަރާތެއްގެ ނަމުގައި  
 ހިމެނޭ ފަރާތެއްގެ ނަމުގައި ހިމެނޭ ފަރާތެއްގެ ނަމުގައި

9.4 ޔަދުކުރެއްވުމަށް ޖަހާ ސަރުކާރުގެ ނަމުގައި ހިމެނޭ ފަރާތެއްގެ ނަމުގައި  
 ހިމެނޭ ފަރާތެއްގެ ނަމުގައި ހިމެނޭ ފަރާތެއްގެ ނަމުގައި

10 ސަރުކާރުގެ ނަމުގައި ހިމެނޭ ފަރާތެއްގެ ނަމުގައި ހިމެނޭ ފަރާތެއްގެ ނަމުގައި  
 ހިމެނޭ ފަރާތެއްގެ ނަމުގައި ހިމެނޭ ފަރާތެއްގެ ނަމުގައި

10.1 ޔަދުކުރެއްވުމަށް ޖަހާ ސަރުކާރުގެ ނަމުގައި ހިމެނޭ ފަރާތެއްގެ ނަމުގައި  
 ހިމެނޭ ފަރާތެއްގެ ނަމުގައި ހިމެނޭ ފަރާތެއްގެ ނަމުގައި

10.2 ޔަދުކުރެއްވުމަށް ޖަހާ ސަރުކާރުގެ ނަމުގައި ހިމެނޭ ފަރާތެއްގެ ނަމުގައި  
 ހިމެނޭ ފަރާތެއްގެ ނަމުގައި ހިމެނޭ ފަރާތެއްގެ ނަމުގައި





1- ޖަހަވުމުގެ ޤާނޫނުގެ ދަށުން ތަޢާރުކުރާ ސަލާމް ބޭނުންކުރަމެވެ.

(ހ) ސަލާމް ބޭނުންކުރާ ގޮތްތައް

11.1 ސަލާމް ބޭނުންކުރާ ގޮތްތައް 11.1 ސަލާމް ބޭނުންކުރާ ގޮތްތައް 11.1 ސަލާމް ބޭނުންކުރާ ގޮތްތައް  
އަދި ސަލާމް ބޭނުންކުރާ ގޮތްތައް 11.1 ސަލާމް ބޭނުންކުރާ ގޮތްތައް 11.1 ސަލާމް ބޭނުންކުރާ ގޮތްތައް  
11.1 ސަލާމް ބޭނުންކުރާ ގޮތްތައް 11.1 ސަލާމް ބޭނުންކުރާ ގޮތްތައް 11.1 ސަލާމް ބޭނުންކުރާ ގޮތްތައް  
11.1 ސަލާމް ބޭނުންކުރާ ގޮތްތައް 11.1 ސަލާމް ބޭނުންކުރާ ގޮތްތައް 11.1 ސަލާމް ބޭނުންކުރާ ގޮތްތައް

12.1  
12.1 12.1

13.1  
13.1 13.1

13.2  
13.2 13.2

13.3  
13.3 13.3

13.4  
13.4 13.4

13.5  
13.5 13.5

14.1  
14.1 14.1

14.2  
14.2 14.2



14.3 ޤައުމީ ޖަލްސާތަކުގެ ދަށުން ފަސޭހަ ގޮތެއްގައި 07 (ހަތެއް) ދުވަހުގެ

ޖަލްސާތަކުގެ ދަށުން ފަސޭހަ ގޮތެއްގައި ސަރުކާރުގެ ސެކްރެޓޭރިއެޓް.

15.1 ސަފަޔާ ދުވަހުގެ ފަސޭހަ ގޮތެއްގައި ސަރުކާރުގެ ސެކްރެޓޭރިއެޓްގައި 60 (ފަސޭހަ)

ދުވަހުގެ ދަށުން ސަރުކާރުގެ ސެކްރެޓޭރިއެޓް.

16.1 ސަފަޔާ ދުވަހުގެ ފަސޭހަ ގޮތެއްގައި ސަރުކާރުގެ ސެކްރެޓޭރިއެޓްގައި 60 (ފަސޭހަ)

ދުވަހުގެ ދަށުން ސަރުކާރުގެ ސެކްރެޓޭރިއެޓް.

16.1.1 16 ފަސޭހަ ދުވަހުގެ ފަސޭހަ ގޮތެއްގައި ސަރުކާރުގެ ސެކްރެޓޭރިއެޓް (2 ބަޅަ ދުވަހު)

16.1.2 16 ފަސޭހަ ދުވަހުގެ ފަސޭހަ ގޮތެއްގައި ސަރުކާރުގެ ސެކްރެޓޭރިއެޓްގައި 60 (ފަސޭހަ)

ދުވަހުގެ ދަށުން ސަރުކާރުގެ ސެކްރެޓޭރިއެޓް.

16.1.3 16 ފަސޭހަ ދުވަހުގެ ފަސޭހަ ގޮތެއްގައި ސަރުކާރުގެ ސެކްރެޓޭރިއެޓް

16.1.4 16 ފަސޭހަ ދުވަހުގެ ފަސޭހަ ގޮތެއްގައި ސަރުކާރުގެ ސެކްރެޓޭރިއެޓް (3 ބަޅަ ދުވަހު)

16.1.5 16 ފަސޭހަ ދުވަހުގެ ފަސޭހަ ގޮތެއްގައި ސަރުކާރުގެ ސެކްރެޓޭރިއެޓް (3 ބަޅަ ދުވަހު)

ދުވަހުގެ ދަށުން ސަރުކާރުގެ ސެކްރެޓޭރިއެޓް.

16.1.6 16 ފަސޭހަ ދުވަހުގެ ފަސޭހަ ގޮތެއްގައި ސަރުކާރުގެ ސެކްރެޓޭރިއެޓް (3 ބަޅަ ދުވަހު)

ދުވަހުގެ ދަށުން ސަރުކާރުގެ ސެކްރެޓޭރިއެޓް.

ދުވަހުގެ ދަށުން ސަރުކާރުގެ ސެކްރެޓޭރިއެޓް.

16.1.7 16 ފަސޭހަ ދުވަހުގެ ފަސޭހަ ގޮތެއްގައި ސަރުކާރުގެ ސެކްރެޓޭރިއެޓް (3 ބަޅަ ދުވަހު)

ދުވަހުގެ ދަށުން ސަރުކާރުގެ ސެކްރެޓޭރިއެޓް.

ދުވަހުގެ ދަށުން ސަރުކާރުގެ ސެކްރެޓޭރިއެޓް.

(ހ) ސަފަޔާ ދުވަހުގެ ފަސޭހަ ގޮތެއްގައި ސަރުކާރުގެ ސެކްރެޓޭރިއެޓް (3 ބަޅަ ދުވަހު)

ދުވަހުގެ ދަށުން ސަރުކާރުގެ ސެކްރެޓޭރިއެޓް.

(ށ) ސަފަޔާ ދުވަހުގެ ފަސޭހަ ގޮތެއްގައި ސަރުކާރުގެ ސެކްރެޓޭރިއެޓް (3 ބަޅަ ދުވަހު)

ދުވަހުގެ ދަށުން ސަރުކާރުގެ ސެކްރެޓޭރިއެޓް.

ދުވަހުގެ ދަށުން ސަރުކާރުގެ ސެކްރެޓޭރިއެޓް.

(ނ) ސަފަޔާ ދުވަހުގެ ފަސޭހަ ގޮތެއްގައި ސަރުކާރުގެ ސެކްރެޓޭރިއެޓް (3 ބަޅަ ދުވަހު)

ދުވަހުގެ ދަށުން ސަރުކާރުގެ ސެކްރެޓޭރިއެޓް.





ހ.ހ. ހޯރާފުޅީ ސަރުކާރުގެ ސަލާމް ބޭނުންކުރަމެވެ.

16.1.9 ޖަނަވަރު 16 ވަނަ ދުވަހުގެ ރިޔާސީ ބަލާލުމުގެ ނަތީޖާ ބޭނުންކުރަމެވެ.

ސަލާމް ބޭނުންކުރަމެވެ.

(ހ) ޖަނަވަރު 16 ވަނަ ދުވަހުގެ ރިޔާސީ ބަލާލުމުގެ ނަތީޖާ ބޭނުންކުރަމެވެ.

ސަލާމް ބޭނުންކުރަމެވެ.

(ށ) ޖަނަވަރު 16 ވަނަ ދުވަހުގެ ރިޔާސީ ބަލާލުމުގެ ނަތީޖާ ބޭނުންކުރަމެވެ.

ސަލާމް ބޭނުންކުރަމެވެ.

(ނ) ޖަނަވަރު 16 ވަނަ ދުވަހުގެ ރިޔާސީ ބަލާލުމުގެ ނަތީޖާ ބޭނުންކުރަމެވެ.

ޖަނަވަރު 16 ވަނަ ދުވަހުގެ ރިޔާސީ ބަލާލުމުގެ ނަތީޖާ ބޭނުންކުރަމެވެ.

ޖަނަވަރު 16 ވަނަ ދުވަހުގެ ރިޔާސީ ބަލާލުމުގެ ނަތީޖާ ބޭނުންކުރަމެވެ.

(ރ) ޖަނަވަރު 16 ވަނަ ދުވަހުގެ ރިޔާސީ ބަލާލުމުގެ ނަތީޖާ ބޭނުންކުރަމެވެ.

ޖަނަވަރު 16 ވަނަ ދުވަހުގެ ރިޔާސީ ބަލާލުމުގެ ނަތީޖާ ބޭނުންކުރަމެވެ.

(ބ) ޖަނަވަރު 16 ވަނަ ދުވަހުގެ ރިޔާސީ ބަލާލުމުގެ ނަތީޖާ ބޭނުންކުރަމެވެ.

16.1.10 ޖަނަވަރު 4 ވަނަ ދުވަހުގެ ރިޔާސީ ބަލާލުމުގެ ނަތީޖާ ބޭނުންކުރަމެވެ.

ޖަނަވަރު 4 ވަނަ ދުވަހުގެ ރިޔާސީ ބަލާލުމުގެ ނަތީޖާ ބޭނުންކުރަމެވެ.

ސަލާމް ބޭނުންކުރަމެވެ.

16.2 ޖަނަވަރު 16 ވަނަ ދުވަހުގެ ރިޔާސީ ބަލާލުމުގެ ނަތީޖާ ބޭނުންކުރަމެވެ.

ސަލާމް ބޭނުންކުރަމެވެ.

16.2.1 ޖަނަވަރު 16 ވަނަ ދުވަހުގެ ރިޔާސީ ބަލާލުމުގެ ނަތީޖާ ބޭނުންކުރަމެވެ.

ޖަނަވަރު 16 ވަނަ ދުވަހުގެ ރިޔާސީ ބަލާލުމުގެ ނަތީޖާ ބޭނުންކުރަމެވެ.

16.3 ޖަނަވަރު 16 ވަނަ ދުވަހުގެ ރިޔާސީ ބަލާލުމުގެ ނަތީޖާ ބޭނުންކުރަމެވެ.

16.3.1 ޖަނަވަރު 16 ވަނަ ދުވަހުގެ ރިޔާސީ ބަލާލުމުގެ ނަތީޖާ ބޭނުންކުރަމެވެ.

ޖަނަވަރު 16 ވަނަ ދުވަހުގެ ރިޔާސީ ބަލާލުމުގެ ނަތީޖާ ބޭނުންކުރަމެވެ.

(ރ) ޖަނަވަރު 16 ވަނަ ދުވަހުގެ ރިޔާސީ ބަލާލުމުގެ ނަތީޖާ ބޭނުންކުރަމެވެ.

17. ޖަނަވަރު 17 ވަނަ ދުވަހުގެ ރިޔާސީ ބަލާލުމުގެ ނަތީޖާ ބޭނުންކުރަމެވެ.





ދިވެހިރާއްޖޭގެ ޖުމްހޫރިއްޔާ ގުޅިގެން

ދިވެހިރާއްޖޭގެ ޖުމްހޫރިއްޔާ ގުޅިގެން

17.2. ސަބަބު ހިޔާވަހިރުވާ ސަބަބުތަކުގެ ސަބަބުން، ހިޔާވަހިރުވާ ސަބަބުތަކުގެ ސަބަބުން ނުވަތަ ނިމިގެން ދިއުމުގެ ސަބަބުން ސަބަބު ހިޔާވަހިރުވާ ސަބަބުތަކުގެ ސަބަބުން.

17.3. ސަބަބު ހިޔާވަހިރުވާ ސަބަބުތަކުގެ ސަބަބުން، ސަބަބު ހިޔާވަހިރުވާ ސަބަބުތަކުގެ ސަބަބުން ނުވަތަ ނިމިގެން ދިއުމުގެ ސަބަބުން ސަބަބު ހިޔާވަހިރުވާ ސަބަބުތަކުގެ ސަބަބުން.

18. 18.1. ސަބަބު ހިޔާވަހިރުވާ ސަބަބުތަކުގެ ސަބަބުން، ސަބަބު ހިޔާވަހިރުވާ ސަބަބުތަކުގެ ސަބަބުން ނުވަތަ ނިމިގެން ދިއުމުގެ ސަބަބުން ސަބަބު ހިޔާވަހިރުވާ ސަބަބުތަކުގެ ސަބަބުން. (ސަބަބު ހިޔާވަހިރުވާ 01)

18.2. 18.1 ގައި ބަޔާންކޮށްފައިވާ ސަބަބުތަކުގެ ސަބަބުން، ސަބަބު ހިޔާވަހިރުވާ ސަބަބުތަކުގެ ސަބަބުން ނުވަތަ ނިމިގެން ދިއުމުގެ ސަބަބުން ސަބަބު ހިޔާވަހިރުވާ ސަބަބުތަކުގެ ސަބަބުން.

18.3. ހިޔާވަހިރުވާ ސަބަބުތަކުގެ ސަބަބުން، ސަބަބު ހިޔާވަހިރުވާ ސަބަބުތަކުގެ ސަބަބުން ނުވަތަ ނިމިގެން ދިއުމުގެ ސަބަބުން ސަބަބު ހިޔާވަހިރުވާ ސަބަބުތަކުގެ ސަބަބުން.

19. 19.1. ސަބަބު ހިޔާވަހިރުވާ ސަބަބުތަކުގެ ސަބަބުން، ސަބަބު ހިޔާވަހިރުވާ ސަބަބުތަކުގެ ސަބަބުން ނުވަތަ ނިމިގެން ދިއުމުގެ ސަބަބުން ސަބަބު ހިޔާވަހިރުވާ ސަބަބުތަކުގެ ސަބަބުން.

ދިވެހިރާއްޖޭގެ ޖުމްހޫރިއްޔާ ގުޅިގެން

ދިވެހިރާއްޖޭގެ ޖުމްހޫރިއްޔާ ގުޅިގެން

ދިވެހިރާއްޖޭގެ ޖުމްހޫރިއްޔާ ގުޅިގެން

ދިވެހިރާއްޖޭގެ ޖުމްހޫރިއްޔާ ގުޅިގެން

ދިވެހިރާއްޖޭގެ ޖުމްހޫރިއްޔާ ގުޅިގެން

(ބ) ސަބަބު ހިޔާވަހިރުވާ ސަބަބުތަކުގެ ސަބަބުން

20. 20.1. ސަބަބު ހިޔާވަހިރުވާ ސަބަބުތަކުގެ ސަބަބުން، ސަބަބު ހިޔާވަހިރުވާ ސަބަބުތަކުގެ ސަބަބުން ނުވަތަ ނިމިގެން ދިއުމުގެ ސަބަބުން ސަބަބު ހިޔާވަހިރުވާ ސަބަބުތަކުގެ ސަބަބުން.

20.2. ސަބަބު ހިޔާވަހިރުވާ ސަބަބުތަކުގެ ސަބަބުން، ސަބަބު ހިޔާވަހިރުވާ ސަބަބުތަކުގެ ސަބަބުން ނުވަތަ ނިމިގެން ދިއުމުގެ ސަބަބުން ސަބަބު ހިޔާވަހިރުވާ ސަބަބުތަކުގެ ސަބަބުން.

20.3. ސަބަބު ހިޔާވަހިރުވާ ސަބަބުތަކުގެ ސަބަބުން، ސަބަބު ހިޔާވަހިރުވާ ސަބަބުތަކުގެ ސަބަބުން ނުވަތަ ނިމިގެން ދިއުމުގެ ސަބަބުން ސަބަބު ހިޔާވަހިރުވާ ސަބަބުތަކުގެ ސަބަބުން.















35.1 35.1 ޤައުމީ ޖުމްހޫރިއްޔާ ދެކޮޅަށް ސަލާމް ބޭނުންކުރަމެވެ.  
ޤައުމީ ޖުމްހޫރިއްޔާ ދެކޮޅަށް ސަލާމް ބޭނުންކުރަމެވެ.

35.2 ޤައުމީ ޖުމްހޫރިއްޔާ ދެކޮޅަށް ސަލާމް ބޭނުންކުރަމެވެ.

35.3 ޤައުމީ ޖުމްހޫރިއްޔާ ދެކޮޅަށް ސަލާމް ބޭނުންކުރަމެވެ.  
ޤައުމީ ޖުމްހޫރިއްޔާ ދެކޮޅަށް ސަލާމް ބޭނުންކުރަމެވެ.  
ޤައުމީ ޖުމްހޫރިއްޔާ ދެކޮޅަށް ސަލާމް ބޭނުންކުރަމެވެ.  
ޤައުމީ ޖުމްހޫރިއްޔާ ދެކޮޅަށް ސަލާމް ބޭނުންކުރަމެވެ.

35.4 ޤައުމީ ޖުމްހޫރިއްޔާ ދެކޮޅަށް ސަލާމް ބޭނުންކުރަމެވެ.  
ޤައުމީ ޖުމްހޫރިއްޔާ ދެކޮޅަށް ސަލާމް ބޭނުންކުރަމެވެ.

36.1 36.1 ޤައުމީ ޖުމްހޫރިއްޔާ ދެކޮޅަށް ސަލާމް ބޭނުންކުރަމެވެ.  
10.71 ޤައުމީ ޖުމްހޫރިއްޔާ ދެކޮޅަށް ސަލާމް ބޭނުންކުރަމެވެ.

36.2 36.2 ޤައުމީ ޖުމްހޫރިއްޔާ ދެކޮޅަށް ސަލާމް ބޭނުންކުރަމެވެ.  
5,000,000/- ޤައުމީ ޖުމްހޫރިއްޔާ ދެކޮޅަށް ސަލާމް ބޭނުންކުރަމެވެ.  
0.005 ޤައުމީ ޖުމްހޫރިއްޔާ ދެކޮޅަށް ސަލާމް ބޭނުންކުރަމެވެ.

CP\*0.005\*LD = ޤައުމީ ޖުމްހޫރިއްޔާ ދެކޮޅަށް ސަލާމް ބޭނުންކުރަމެވެ.

CP (ޤައުމީ ޖުމްހޫރިއްޔާ ދެކޮޅަށް ސަލާމް ބޭނުންކުރަމެވެ): ޤައުމީ ޖުމްހޫރިއްޔާ ދެކޮޅަށް ސަލާމް ބޭނުންކުރަމެވެ.

LD (ޤައުމީ ޖުމްހޫރިއްޔާ ދެކޮޅަށް ސަލާމް ބޭނުންކުރަމެވެ): ޤައުމީ ޖުމްހޫރިއްޔާ ދެކޮޅަށް ސަލާމް ބޭނުންކުރަމެވެ.

36.3 36.3 ޤައުމީ ޖުމްހޫރިއްޔާ ދެކޮޅަށް ސަލާމް ބޭނުންކުރަމެވެ.  
5,000,000/- ޤައުމީ ޖުމްހޫރިއްޔާ ދެކޮޅަށް ސަލާމް ބޭނުންކުރަމެވެ.  
0.0025 ޤައުމީ ޖުމްހޫރިއްޔާ ދެކޮޅަށް ސަލާމް ބޭނުންކުރަމެވެ.

CP\*0.0025\*LD = ޤައުމީ ޖުމްހޫރިއްޔާ ދެކޮޅަށް ސަލާމް ބޭނުންކުރަމެވެ.

CP (ޤައުމީ ޖުމްހޫރިއްޔާ ދެކޮޅަށް ސަލާމް ބޭނުންކުރަމެވެ): ޤައުމީ ޖުމްހޫރިއްޔާ ދެކޮޅަށް ސަލާމް ބޭނުންކުރަމެވެ.

LD (ޤައުމީ ޖުމްހޫރިއްޔާ ދެކޮޅަށް ސަލާމް ބޭނުންކުރަމެވެ): ޤައުމީ ޖުމްހޫރިއްޔާ ދެކޮޅަށް ސަލާމް ބޭނުންކުރަމެވެ.





بِسْمِ اللَّهِ الرَّحْمَنِ الرَّحِيمِ

Secretariat of The Hoarafushi Council  
 HA· Hoarafushi  
 Republic of Maldives



މަލިވެހިސަރުކާރުގެ ގެޒެޓް 2022 ވަނަ ބަލަންދު  
 ގަވާއިދު ގެ ދަށުން  
 ބޭނުންކޮށް ފަތުރުވެރިންނަށް ދަންނަވާ ސަލާމަތުގެ ޖަލާލު

އިތުރު ފޮތްތަކާއި ލިޔެކިޔުންތަކާ ގުޅިގެން ފަތުރުވެރިންނަށް ދަންނަވާ ސަލާމަތުގެ ޖަލާލު  
 ގެ ތެރޭގައި ހިމެނޭ ޕެންޑުލަމް ފޯމް ފުރިހަމަކުރުމާ ގުޅިގެން ފަތުރުވެރިންނަށް ދަންނަވާ ސަލާމަތުގެ ޖަލާލު  
 ފޯމް ފުރިހަމަކުރުމާ ގުޅިގެން ފަތުރުވެރިންނަށް ދަންނަވާ ސަލާމަތުގެ ޖަލާލު

40. ބޭނުންކޮށް ފަތުރުވެރިންނަށް ދަންނަވާ ސަލާމަތުގެ ޖަލާލު ފޯމް ފުރިހަމަކުރުމާ ގުޅިގެން ފަތުރުވެރިންނަށް ދަންނަވާ ސަލާމަތުގެ ޖަލާލު  
 40.1 ބޭނުންކޮށް ފަތުރުވެރިންނަށް ދަންނަވާ ސަލާމަތުގެ ޖަލާލު ފޯމް ފުރިހަމަކުރުމާ ގުޅިގެން ފަތުރުވެރިންނަށް ދަންނަވާ ސަލާމަތުގެ ޖަލާލު

41. ބޭނުންކޮށް ފަތުރުވެރިންނަށް ދަންނަވާ ސަލާމަތުގެ ޖަލާލު ފޯމް ފުރިހަމަކުރުމާ ގުޅިގެން ފަތުރުވެރިންނަށް ދަންނަވާ ސަލާމަތުގެ ޖަލާލު  
 41.1 ބޭނުންކޮށް ފަތުރުވެރިންނަށް ދަންނަވާ ސަލާމަތުގެ ޖަލާލު ފޯމް ފުރިހަމަކުރުމާ ގުޅިގެން ފަތުރުވެރިންނަށް ދަންނަވާ ސަލާމަތުގެ ޖަލާލު

42. ބޭނުންކޮށް ފަތުރުވެރިންނަށް ދަންނަވާ ސަލާމަތުގެ ޖަލާލު ފޯމް ފުރިހަމަކުރުމާ ގުޅިގެން ފަތުރުވެރިންނަށް ދަންނަވާ ސަލާމަތުގެ ޖަލާލު  
 42.1 ބޭނުންކޮށް ފަތުރުވެރިންނަށް ދަންނަވާ ސަލާމަތުގެ ޖަލާލު ފޯމް ފުރިހަމަކުރުމާ ގުޅިގެން ފަތުރުވެރިންނަށް ދަންނަވާ ސަލާމަތުގެ ޖަލާލު

43. ބޭނުންކޮށް ފަތުރުވެރިންނަށް ދަންނަވާ ސަލާމަތުގެ ޖަލާލު ފޯމް ފުރިހަމަކުރުމާ ގުޅިގެން ފަތުރުވެރިންނަށް ދަންނަވާ ސަލާމަތުގެ ޖަލާލު  
 43.1 ބޭނުންކޮށް ފަތުރުވެރިންނަށް ދަންނަވާ ސަލާމަތުގެ ޖަލާލު ފޯމް ފުރިހަމަކުރުމާ ގުޅިގެން ފަތުރުވެރިންނަށް ދަންނަވާ ސަލާމަތުގެ ޖަލާލު

43.2 ބޭނުންކޮށް ފަތުރުވެރިންނަށް ދަންނަވާ ސަލާމަތުގެ ޖަލާލު ފޯމް ފުރިހަމަކުރުމާ ގުޅިގެން ފަތުރުވެރިންނަށް ދަންނަވާ ސަލާމަތުގެ ޖަލާލު  
 43.2 ބޭނުންކޮށް ފަތުރުވެރިންނަށް ދަންނަވާ ސަލާމަތުގެ ޖަލާލު ފޯމް ފުރިހަމަކުރުމާ ގުޅިގެން ފަތުރުވެރިންނަށް ދަންނަވާ ސަލާމަތުގެ ޖަލާލު



ސަވަނަ - 4

ޖަދުވަލު 1

1 - ޖަދުވަލު

ސަވަނަ ނަންބަރު ގަތި ޖަދުވަލު 1 ގެ ސަވަނަ ނަންބަރު ތަކުގެ ތެރެއިން ބަޔާންކޮށްފައިވާ ސަވަނަ ނަންބަރުތަކެވެ.

ޖަދުވަލު 1 ސަވަނަ ނަންބަރު	ނަންބަރު ފޯމުލާ ހިސާބުގައި ބަޔާންކޮށްފައިވާ ސަވަނަ ނަންބަރު	#
<p>ސަވަނަ ނަންބަރު ގަތި ޖަދުވަލު 1 ގެ ސަވަނަ ނަންބަރު ތަކުގެ ތެރެއިން ބަޔާންކޮށްފައިވާ ސަވަނަ ނަންބަރުތަކެވެ.</p>		
	( 2 ޖަދުވަލު )	1
	ޖަދުވަލު 1 ގެ ސަވަނަ ނަންބަރު ތަކުގެ ތެރެއިން ބަޔާންކޮށްފައިވާ ސަވަނަ ނަންބަރުތަކެވެ.	2
	ނަންބަރު ފޯމުލާ ހިސާބުގައި ބަޔާންކޮށްފައިވާ ސަވަނަ ނަންބަރުތަކެވެ. ( 3 ޖަދުވަލު )	3
	ނަންބަރު ފޯމުލާ ހިސާބުގައި ބަޔާންކޮށްފައިވާ ސަވަނަ ނަންބަރުތަކެވެ.	4
	ނަންބަރު ފޯމުލާ ހިސާބުގައި ބަޔާންކޮށްފައިވާ ސަވަނަ ނަންބަރުތަކެވެ.	5
	ނަންބަރު ފޯމުލާ ހިސާބުގައި ބަޔާންކޮށްފައިވާ ސަވަނަ ނަންބަރުތަކެވެ.	6
	ނަންބަރު ފޯމުލާ ހިސާބުގައި ބަޔާންކޮށްފައިވާ ސަވަނަ ނަންބަރުތަކެވެ.	7
	ނަންބަރު ފޯމުލާ ހިސާބުގައި ބަޔާންކޮށްފައިވާ ސަވަނަ ނަންބަރުތަކެވެ.	8
	ނަންބަރު ފޯމުލާ ހިސާބުގައި ބަޔާންކޮށްފައިވާ ސަވަނަ ނަންބަރުތަކެވެ.	9
<p>ސަވަނަ ނަންބަރު ގަތި ޖަދުވަލު 1 ގެ ސަވަނަ ނަންބަރު ތަކުގެ ތެރެއިން ބަޔާންކޮށްފައިވާ ސަވަނަ ނަންބަރުތަކެވެ.</p>		

بِسْمِ اللَّهِ الرَّحْمَنِ الرَّحِيمِ

Secretariat of The Hoarafushi Council  
 HA· Hoarafushi  
 Republic of Maldives



ދިވެހިސަރުކާރުގެ ގެޒެޓް ގައި ބަޔާންކޮށްފައިވާ ގޮތުގައި ހުށަހަޅާ ފަރާތްތަކުގެ ނަންބަރު 5 ގެ ތެރޭގައި ހިމެނޭ ފަރާތްތަކުގެ ނަންބަރު 10 ގެ ތެރޭގައި ހިމެނޭ ފަރާތްތަކުގެ ނަންބަރު 11 ގެ ތެރޭގައި ހިމެނޭ ފަރާތްތަކުގެ ނަންބަރު 12 ގެ ތެރޭގައި ހިމެނޭ ފަރާތްތަކުގެ ނަންބަރު 13 ގެ ތެރޭގައި ހިމެނޭ ފަރާތްތަކުގެ ނަންބަރު 14 ގެ ތެރޭގައި ހިމެނޭ ފަރާތްތަކުގެ ނަންބަރު

		5	10
		11	11
			12
			13
			14



info@hoarafushi.gov.mv



www.hoarafushicouncil.gov.mv



@Hoara\_council



/Hoarafushicouncil



+960 6500012 | President:7945313 | Head Of CS:6500051



+9607851565





بِسْمِ اللّٰهِ الرَّحْمٰنِ الرَّحِیْمِ

Secretariat of The Hoarafushi Council  
HA· Hoarafushi  
Republic of Maldives



ދިވެހިސަރުކާރުގެ ގެޒެޓް  
ގަވާއިދު ނުވަތަ ފަންޞަރުކާރުގެ ގަވާއިދު  
2022 ވަނަ ބައި  
ސަފީރުގެ ބަނޑު  
ނުވަތަ ޕެސެޖަރުގެ ބަނޑު  
ބޭނުންކުރާ ފަރާތްތަކުގެ ތެރެއިން  
ރާއްޖެއަށް ވަދެގެން ދާ ފަރާތްތަކުގެ ނަންބަރު ފޮތްތަކުގެ ބަނޑު  
ނުވަތަ ފަންޞަރުކާރުގެ ގަވާއިދު 2022 ވަނަ ބައި 100 ވަނަ ބައި

4 - ބަނޑު

ޖެނެރަލް ޕެސެޖަރުގެ ބަނޑު

ސަފީރުގެ ބަނޑު				
ޖެނެރަލް ޕެސެޖަރުގެ ބަނޑު (ފުރުފަތް)	ރާއްޖެއަށް ވަދެގެން ދާ ފަރާތްތަކުގެ ނަންބަރު	ރާއްޖެއަށް ފޮނުވާ ފަރާތްތަކުގެ ނަންބަރު	#	
		ޖެނެރަލް		
ޕެސެޖަރުގެ ބަނޑު				
ޕެސެޖަރުގެ ބަނޑު (ފުރުފަތް ނުވަތަ ޕެސެޖަރުގެ ބަނޑު)	ޕެސެޖަރުގެ ބަނޑު	ޕެސެޖަރުގެ ބަނޑު	ޕެސެޖަރުގެ ބަނޑު	#
		ޖެނެރަލް		







بِسْمِ اللّٰهِ الرَّحْمٰنِ الرَّحِیْمِ

Secretariat of The Hoarafushi Council  
 HA· Hoarafushi  
 Republic of Maldives



ދިވެހިރާއްޖޭގެ ޖުމްހޫރިއްޔާ ގުޅިގެން  
 ރ.ރ. ދިވެހިރާއްޖޭގެ ޖުމްހޫރިއްޔާ ގުޅިގެން  
 50 GOLDEN YEAR - TOURISM 2022

ސަވަނަ 5 -

ނަންބަރު ޕްރޮޖެކްޓް ޖެޓް ސަވަނަ	ޕްރޮޖެކްޓް ޖެޓް ސަވަނަ
	<p>ސަވަނަ 5.1</p> <p>ސަވަނަ 5.1: ޖުމްހޫރިއްޔާ ގުޅިގެން ރ.ރ. ދިވެހިރާއްޖޭގެ ޖުމްހޫރިއްޔާ ގުޅިގެން</p>
	<p>ސަވަނަ 5.2</p> <p>ސަވަނަ 5.2: ޖުމްހޫރިއްޔާ ގުޅިގެން ރ.ރ. ދިވެހިރާއްޖޭގެ ޖުމްހޫރިއްޔާ ގުޅިގެން</p>
	<p>ސަވަނަ 5.3</p> <p>ސަވަނަ 5.3: ޖުމްހޫރިއްޔާ ގުޅިގެން ރ.ރ. ދިވެހިރާއްޖޭގެ ޖުމްހޫރިއްޔާ ގުޅިގެން</p>
	<p>ސަވަނަ 5.4</p> <p>ސަވަނަ 5.4: ޖުމްހޫރިއްޔާ ގުޅިގެން ރ.ރ. ދިވެހިރާއްޖޭގެ ޖުމްހޫރިއްޔާ ގުޅިގެން</p>
	<p>ސަވަނަ 5.5</p> <p>ސަވަނަ 5.5: ޖުމްހޫރިއްޔާ ގުޅިގެން ރ.ރ. ދިވެހިރާއްޖޭގެ ޖުމްހޫރިއްޔާ ގުޅިގެން</p>





بِسْمِ اللّٰهِ الرَّحْمٰنِ الرَّحِیْمِ



ސަވަދު 7 -

ސަވަދުގެ ގަވާއިދު

- 1.1 1. ސަވަދުގެ ނަންބަރު 25 ގެ ބޭރު ޖަދުވަލުގެ ދަށުން 20 ޖަދުވަލުގެ ނަންބަރު 2 ގެ ބޭރު ޖަދުވަލުގެ ދަށުން ޕްރޮސެސަރުގެ ސަރަޙައްދީ ސަރުކާރުގެ ޕްރޮސެޅުމަށް ދަނީ ސަވަދުގެ ނަންބަރު 2 ގެ ބޭރު ޖަދުވަލުގެ ދަށުން ޕްރޮސެސަރުގެ ސަރަޙައްދީ ސަރުކާރުގެ ޕްރޮސެޅުމަށް ދަނީ ސަވަދުގެ ނަންބަރު 2 ގެ ބޭރު ޖަދުވަލުގެ ދަށުން ޕްރޮސެޅުމަށް ދަނީ ސަވަދުގެ ނަންބަރު 2 ގެ ބޭރު ޖަދުވަލުގެ ދަށުން ޕްރޮސެޅުމަށް ދަނީ...
- 2.1 2. ސަވަދުގެ ނަންބަރު 2 ގެ ބޭރު ޖަދުވަލުގެ ދަށުން ޕްރޮސެޅުމަށް ދަނީ ސަވަދުގެ ނަންބަރު 2 ގެ ބޭރު ޖަދުވަލުގެ ދަށުން ޕްރޮސެޅުމަށް ދަނީ...
- 3.1 3. ސަވަދުގެ ނަންބަރު 2 ގެ ބޭރު ޖަދުވަލުގެ ދަށުން ޕްރޮސެޅުމަށް ދަނީ ސަވަދުގެ ނަންބަރު 2 ގެ ބޭރު ޖަދުވަލުގެ ދަށުން ޕްރޮސެޅުމަށް ދަނީ...
- 3.2 ސަވަދުގެ ނަންބަރު 2 ގެ ބޭރު ޖަދުވަލުގެ ދަށުން ޕްރޮސެޅުމަށް ދަނީ ސަވަދުގެ ނަންބަރު 2 ގެ ބޭރު ޖަދުވަލުގެ ދަށުން ޕްރޮސެޅުމަށް ދަނީ...
- 3.3 ސަވަދުގެ ނަންބަރު 2 ގެ ބޭރު ޖަދުވަލުގެ ދަށުން ޕްރޮސެޅުމަށް ދަނީ ސަވަދުގެ ނަންބަރު 2 ގެ ބޭރު ޖަދުވަލުގެ ދަށުން ޕްރޮސެޅުމަށް ދަނީ...
- 3.4 ސަވަދުގެ ނަންބަރު 2 ގެ ބޭރު ޖަދުވަލުގެ ދަށުން ޕްރޮސެޅުމަށް ދަނީ ސަވަދުގެ ނަންބަރު 2 ގެ ބޭރު ޖަދުވަލުގެ ދަށުން ޕްރޮސެޅުމަށް ދަނީ...



بِسْمِ اللَّهِ الرَّحْمَنِ الرَّحِيمِ

Secretariat of The Hoarafushi Council  
HA· Hoarafushi  
Republic of Maldives

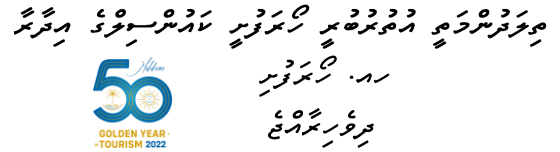

## ANEX 01

### Equipment BOQ

#	ITEM	DESCRIPTION	UOM	QUANTITY
1	DOUBLE CUBE	100CM x 50CM x 40CM	EA	640
2	SMALL SHORT PIN	20CM x 18CM	EA	440
3	LONG PIN	63.5CM x 18CM x 4.8CM	EA	220
4	SIDE FIXING BOLT	56CM x 5CM	EA	440
5	EXTARNAL PIN	Ø9CM x 1.8CM	EA	1100
6	SPACER	Ø9CM x 1.8CM	EA	1100
7	SMALL SWIMMING LEDER	FOR TWO LAYERS	EA	2
8	FENDER	1M	EA	115
9	BOX WRENCH	GALVANIZED IRON	EA	4
10	TORQUE WRENCH	304 STEEL	EA	4
11	FLOODING KEY	304 STEEL	EA	4
12	SCREW IN ANCHOR POINTS	304 STEEL	EA	8
13	PUSH PAD	2000MM X 3000MM	EA	16
14	STATING BLOCK	500MM X 600MM X 395MM	EA	8
15	POOL LANE LINE	9CM X 20CM	MTR	250
15	GALVANIZED CHAIN	GALVANIZED IRON	MTR	160



info@hoarafushi.gov.mv



www.hoarafushicouncil.gov.mv



@Hoara\_council



/Hoarafushicouncil



+960 6500012 | President:7945313 | Head Of CS:6500051



+9607851565

ANEX 02

Equipment General Specification

Drawing	
Plastic Quality	HDPE ( High-density polyethylene) Plastic
Steel Pipe Quality	-
Color	Blue
Size	100CM x 50CM x 40CM
Name	DOUBLE CUBE
Quantity	640 EA

Drawing	
Plastic Quality	HDPE ( High-density polyethylene) Plastic
Steel Quality	-
Color	Gray
Size	20CM x 18CM
Name	SMALL SHORT PIN
Quantity	440 EA



بِسْمِ اللّٰهِ الرَّحْمٰنِ الرَّحِیْمِ

Secretariat of The Hoarafushi Council  
HA· Hoarafushi  
Republic of Maldives

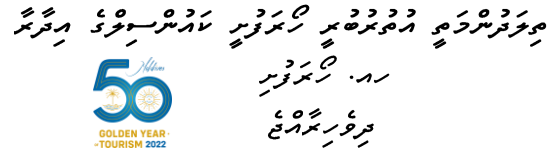

Drawing	
Plastic Quality	HDPE ( High-density polyethylene) Plastic
Steel Quality	-
Color	Blue
Size	63.5CM x 18CM x 4.8CM
Name	LONG PIN
Quantity	220 EA

Drawing	
Plastic Quality	HDPE ( High-density polyethylene) Plastic
Steel Quality	-
Color	Blue
Size	56CM x 5CM
Name	SIDE FIXING BOLT
Quantity	440



info@hoarafushi.gov.mv



www.hoarafushicouncil.gov.mv



@Hoara\_council



/Hoarafushicouncil



+960 6500012

President:7945313|Head Of CS:6500051





+9607851565

بِسْمِ اللّٰهِ الرَّحْمٰنِ الرَّحِیْمِ

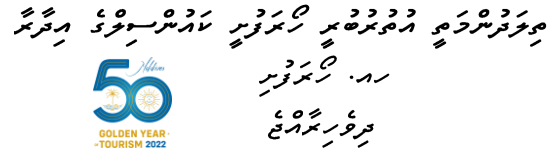
Secretariat of The Hoarafushi Council  
HA· Hoarafushi  
Republic of Maldives



Drawing	
Plastic Quality	HDPE ( High-density polyethylene) Plastic
Steel Quality	-
Color	BLACK
Size	Ø9CM x 1.8CM
Name	SPACER
Quantity	1100 EA

Drawing	
Plastic Quality	HDPE ( High-density polyethylene) Plastic
Steel Quality	-
Color	BLACK
Size	Ø9CM x 1.8CM
Name	EXTERNAL PIN
Quantity	1100 EA



info@hoarafushi.gov.mv



www.hoarafushicouncil.gov.mv



@Hoara\_council



/Hoarafushicouncil



+960 6500012 | President:7945313|Head Of CS:6500051



+9607851565

بِسْمِ اللّٰهِ الرَّحْمٰنِ الرَّحِیْمِ

Secretariat of The Hoarafushi Council  
HA· Hoarafushi  
Republic of Maldives

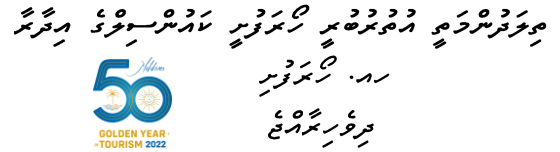

Drawing	
Plastic Quality	HDPE ( High-density polyethylene) Plastic
Steel Quality	304 Steel
Color	White
Size	FOR TWO LAYERS
Name	SMALL SWIMMING LEDER
Quantity	2 EA

Drawing	
Plastic Quality	HDPE ( High-density polyethylene) Plastic
Steel Quality	-
Color	Yellow
Size	1 Meter
Name	FENDER
Quantity	115 EA



info@hoarafushi.gov.mv



www.hoarafushicouncil.gov.mv



@Hoara\_council



/Hoarafushicouncil



+960 6500012 | President:7945313|Head Of CS:6500051





+9607851565

بِسْمِ اللّٰهِ الرَّحْمٰنِ الرَّحِیْمِ

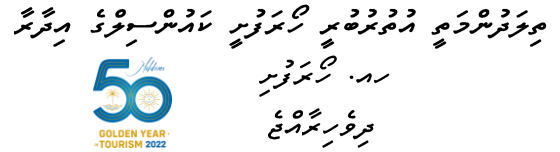
Secretariat of The Hoarafushi Council  
HA· Hoarafushi  
Republic of Maldives



Drawing	
Plastic Quality	-
Steel Pipe Quality	GALVANIZED IRON
Color	-
Size	-
Name	BOX WRENCH
Quantity	4 EA

Drawing	
Plastic Quality	-
Steel Quality	304 STEEL
Color	-
Size	-
Name	TORQUE WRENCH
Quantity	4 EA



info@hoarafushi.gov.mv



www.hoarafushicouncil.gov.mv



@Hoara\_council



/Hoarafushicouncil



+960 6500012 | President:7945313 | Head Of CS:6500051



+9607851565

بِسْمِ اللّٰهِ الرَّحْمٰنِ الرَّحِیْمِ

Secretariat of The Hoarafushi Council  
HA· Hoarafushi  
Republic of Maldives

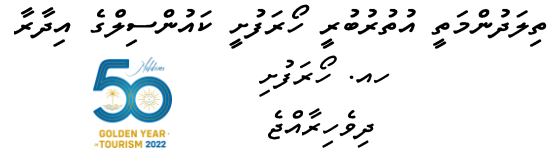

Drawing	
Plastic Quality	-
Steel Quality	304 STEEL
Color	-
Size	-
Name	FLOODING KEY
Quantity	4

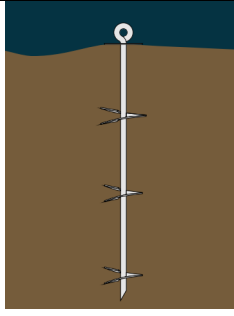
Drawing	
Plastic Quality	-
Steel Quality	304 STEEL
Color	-
Size	-
Name	SCREW IN ANCHOR POINTS
Quantity	8



info@hoarafushi.gov.mv



www.hoarafushicouncil.gov.mv



@Hoara\_council



/Hoarafushicouncil



+960 6500012 | President:7945313|Head Of CS:6500051



+9607851565

بِسْمِ اللّٰهِ الرَّحْمٰنِ الرَّحِیْمِ

Secretariat of The Hoarafushi Council  
HA· Hoarafushi  
Republic of Maldives

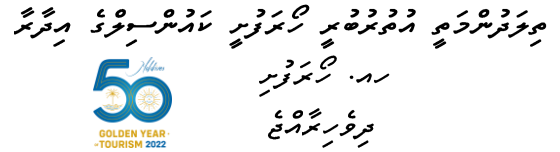

Drawing	
Plastic Quality	HDPE ( High-density polyethylene) Plastic
Steel Quality	304 STEEL
Color	White
Size	-
Name	PUSH PAD
Quantity	16

Drawing	
Plastic Quality	HDPE ( High-density polyethylene) Plastic
Steel Quality	304 STEEL
Color	White
Size	-
Name	STATING BLOCK
Quantity	8



info@hoarafushi.gov.mv



www.hoarafushicouncil.gov.mv



@Hoara\_council



/Hoarafushicouncil



+960 6500012 | President:7945313|Head Of CS:6500051



+9607851565

بِسْمِ اللّٰهِ الرَّحْمٰنِ الرَّحِیْمِ

Secretariat of The Hoarafushi Council  
HA· Hoarafushi  
Republic of Maldives

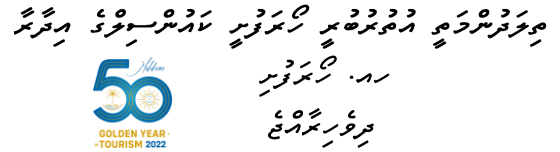

Drawing	
Plastic Quality	-
Steel Quality	GALVANIZED IRON
Color	-
Size	-
Name	GALVANIZED CHAIN
Quantity	160 Meter

Drawing	
Plastic Quality	HDPE ( High-density polyethylene) Plastic
Steel Quality	
Color	-
Size	-
Name	POOL LANE LINE
Quantity	250 Meter



info@hoarafushi.gov.mv



www.hoarafushicouncil.gov.mv



@Hoara\_council



/Hoarafushicouncil



+960 6500012

President:7945313|Head Of CS:6500051



+9607851565

ANEX 03

Drawings

STATING BLOCK

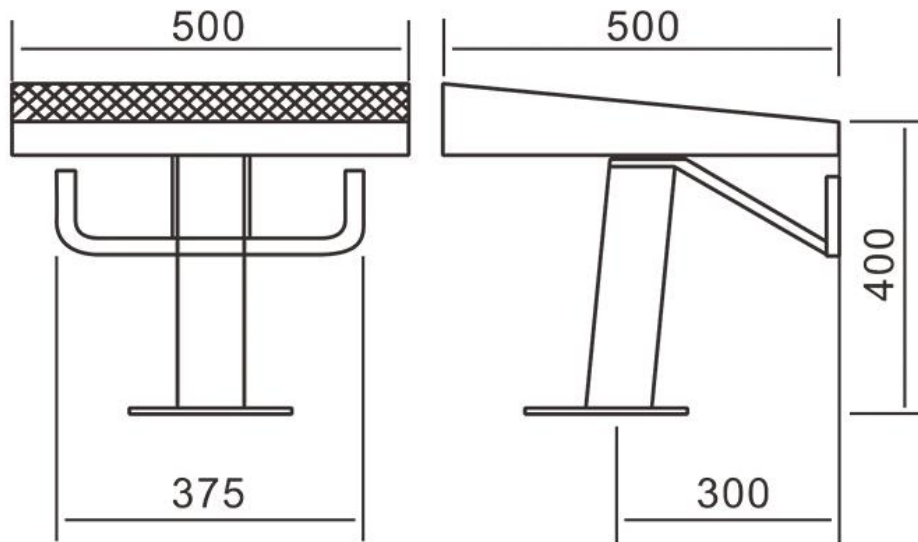



بِسْمِ اللّٰهِ الرَّحْمٰنِ الرَّحِیْمِ

Secretariat of The Hoarafushi Council  
HA· Hoarafushi  
Republic of Maldives



ދިވެހިރާއްޖޭގެ ޖުމްހޫރިއްޔާ ގުޅިގެން  
ދިވެހިރާއްޖޭގެ ޖުމްހޫރިއްޔާ ގުޅިގެން  
ދިވެހިރާއްޖޭގެ ޖުމްހޫރިއްޔާ ގުޅިގެން  
ދިވެހިރާއްޖޭގެ ޖުމްހޫރިއްޔާ ގުޅިގެން  
ދިވެހިރާއްޖޭގެ ޖުމްހޫރިއްޔާ ގުޅިގެން



### PUSH PAD

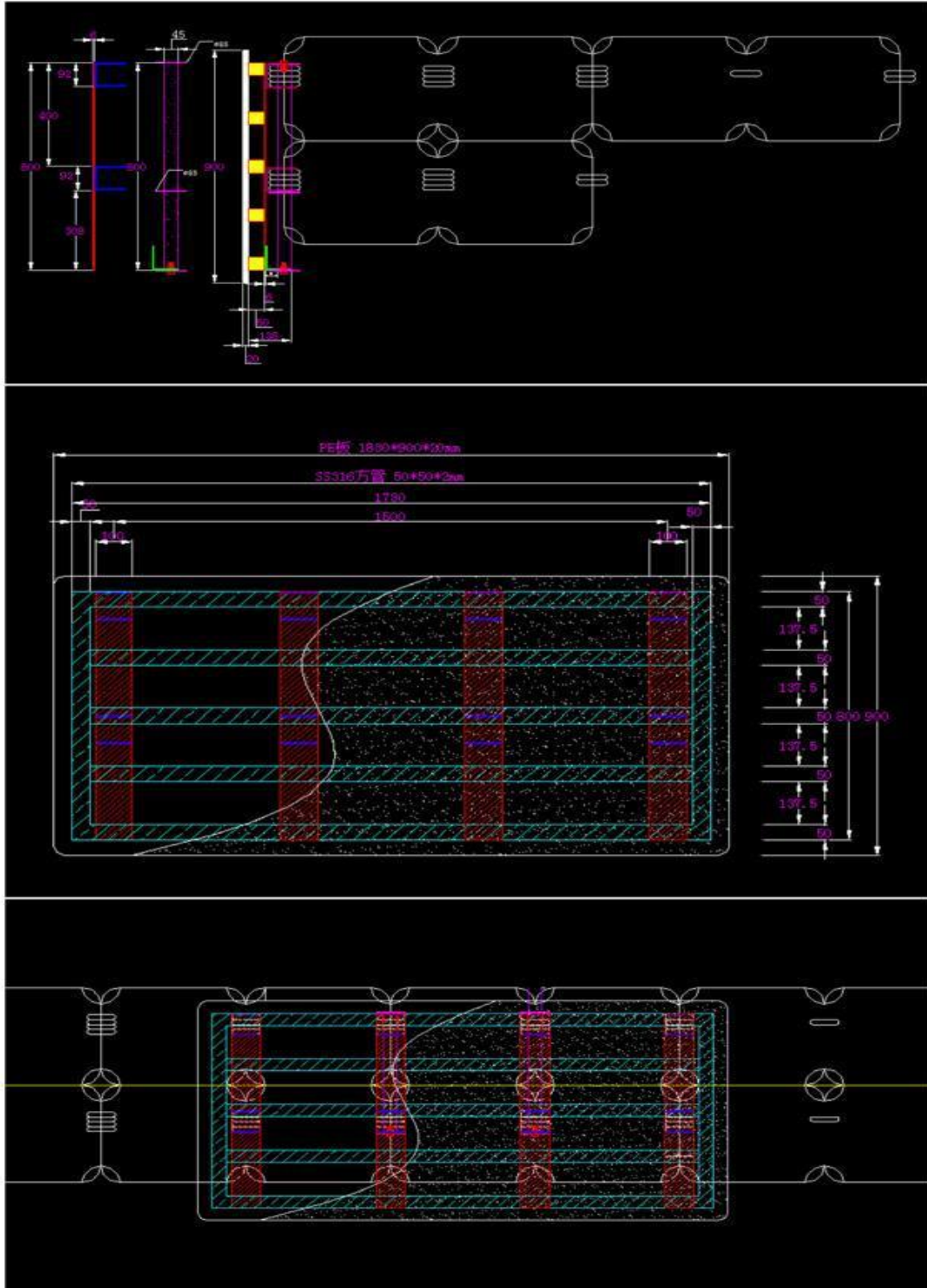

info@hoarafushi.gov.mv



www.hoarafushicouncil.gov.mv



@Hoara\_council



/Hoarafushicouncil



+960 6500012 | President: 7945313 | Head Of CS: 6500051



+9607851565

بِسْمِ اللَّهِ الرَّحْمَنِ الرَّحِيمِ

Secretariat of The Hoarafushi Council  
HA· Hoarafushi  
Republic of Maldives



ދިވެހިރާއްޖޭގެ ޖުމްހޫރިއްޔާ ދެކޮޅަށް  
ހެދިގެން ގޮސްފައިވާ ސަލާމަތީގެ ދަތުރު  
ދަށުން ދަތުރުކުރާ ބަޔަކު ހެއްދެވިގެން  
ދަތުރުކުރާ ބަޔަކު ހެއްދެވިގެން

### SCREW IN ANCHOR POINTS

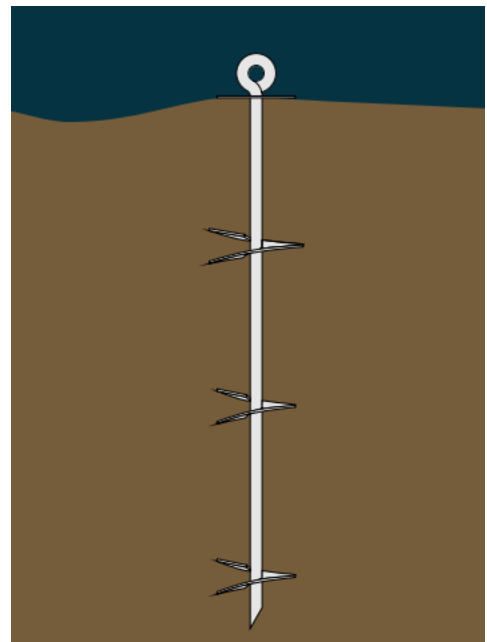
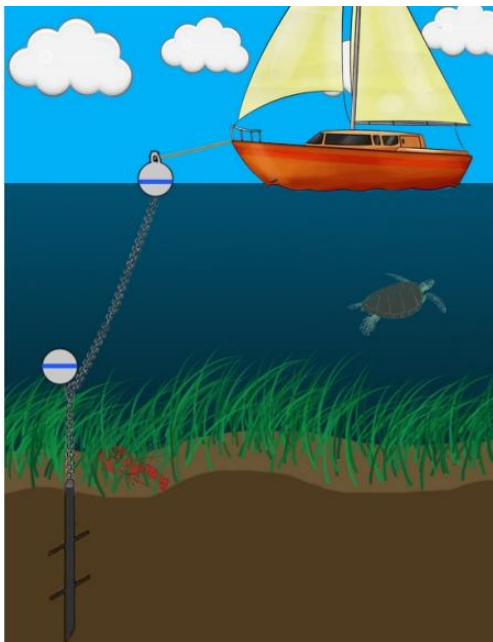
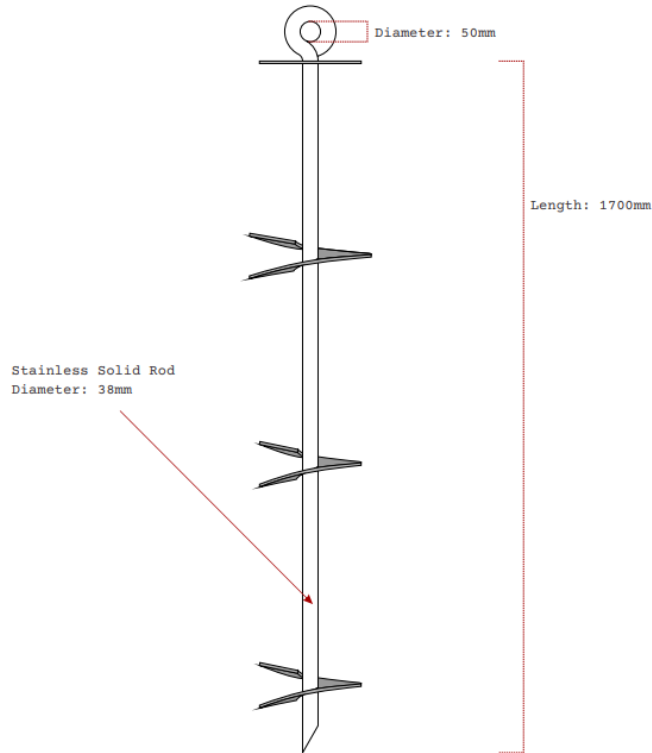

info@hoarafushi.gov.mv



www.hoarafushicouncil.gov.mv



@Hoara\_council



/Hoarafushicouncil



+960 6500012 | President: 7945313 | Head Of CS: 6500051



+9607851565