



HIGH PERFORMANCE LED | LIGHTING & ACCESSORIES



Heise LED Lighting, by Metra Electronics, are exclusively developed and manufactured to meet all international standards. Our range of lighting integrates advanced thermal management, short circuit and open circuit protection and many other innovative features. All products undergo rigorous testing during the development and manufacturing process and again before leaving the factory. Metra's history, experience and approach to engineering and manufacturing ensure that their products stand out among the competitors and are the highest quality lights available on the market.

UNIVERSAL FIT

HIGH PERFORMANCE LED LIGHTING

Auxiliary driving and fog lights are intended for use solely as auxiliary lighting. They are not intended to be used for headlight purposes, nor are they certified for headlight usage. Auxiliary lights are designed to improve visibility during night time driving and inclement weather. Irresponsible use of any auxiliary light can be dangerous and illegal. Auxiliary driving lights are intended to supplement the high-beam of a standard headlamp system. They are not intended for use alone or with the low-beam of a standard headlamp system. Lighting laws vary from state to state.

LED LIGHTBARS	1-20
LIGHTBAR BRACKETS	21-24
CUBE LIGHTS	25-30
DRIVING LIGHTS	31-36
RGB / ACCENT LIGHTS	37-80
VEHICLE LIGHTS	81-98
SADDLE TRAMP	99-108
POWERSPORTS	109-112
METRA MARINE	113-118
HEISE MUNICIPALITY	119-124
HEISE MERCHANDISE	125-130



WARNING: This catalog does not advise whether a State of California Proposition 65 warning is required for a particular item of merchandise. To learn whether a particular item of merchandise requires a California Proposition 65 warning, please be sure to look up and read the particular merchandise's listing on Metra's website www.HeiseLED.com, as well as read the particular merchandise's packaging. When a California Proposition 65 warning is present on Metra's website listing for the particular merchandise, or on the particular merchandise's packaging, a compliant California Proposition 65 warning is to be provided to the purchasing California consumer prior to the sale of the particular merchandise.



DESIGNED
EXCLUSIVELY FOR
OFFROAD!



FEATURES



HEISE QUALITY
LED LIGHTING SYSTEMS

Heise LED Lighting Systems®, by Metra Electronics®, are exclusively engineered and manufactured to meet all international standards. Metra's history, experience and approach to engineering and manufacturing ensure that their products stand out among the competitors and are the highest quality lights available on the market.

The Heise range of lighting technology integrates advanced thermal management, short circuit and open circuit protection, and many other innovative features. All products undergo rigorous testing during the development and manufacturing process and then tested again before leaving the factory.



M MILITARY BREATHER PORT

MACHINED MECHANICAL VENT PORT

1. Allows for any internal moisture to escape which can be caused by extreme heat and rapid cooling
2. Also assists with preventing any external moisture from entering the lightbar housing



H HYBRID SYSTEM

THE BEST OF BOTH WORLDS

Intense spotlights in the center flanked by wide beam driving lights on each side give you everything in one lightbar



U UNIVERSAL DUAL MOUNT SYSTEM

MOUNT ANYWHERE

Heavy-duty rubber foot mounts help reduce vibration for LED lightbars anywhere



V PROTECTIVE VENT PORT

SELF-ADHESIVE ONE-WAY VALVE

A dual-purpose membrane allows internal moisture to pass through and escape while also blocking liquid and particles from infiltrating the housing from the outside

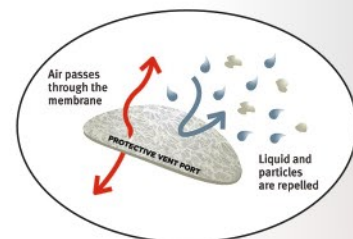

DUAL ROW LED LIGHTBARS

HIGH OUTPUT

HE-HDR8

08 INCH

12 LED

★ IP67 ★
CERTIFIED

Wattage: 36W • Raw Lumens: 3240lm • Lux @ 10m: 1350 lx
Current Consumption @ 13.8V: 2.26A



HE-HDR14

14 INCH

24 LED

★ IP67 ★
CERTIFIED

Wattage: 72W • Raw Lumens: 6480lm • Lux @ 10m: 2700 lx
Current Consumption @ 13.8V: 4.5A



HE-HDR32

32 INCH

60 LED

★ IP67 ★
CERTIFIED

Wattage: 180W • Raw Lumens: 16200lm • Lux @ 10m: 6200 lx
Current Consumption @ 13.8V: 8.8A



HE-HDR42

42 INCH

80 LED

★ IP67 ★
CERTIFIED

Wattage: 240W • Raw Lumens: 21600lm • Lux @ 10m: 7500 lx
Current Consumption @ 13.8V: 16.5A



HE-HDR50

50 INCH

96 LED

★ IP67 ★
CERTIFIED

Wattage: 288W • Raw Lumens: 25920lm • Lux @ 10m: 9500 lx
Current Consumption @ 13.8V: 18.1A





HYBRID



UNIVERSAL



MILITARY BREATHER
MEMBRANE

COMMON FEATURES



INPUT VOLTAGE: 10-30V DC

COLOR TEMPERATURE: 6000K

BEAM PATTERN: COMBO: 90° FLOOD / 8° SPOT

HOUSING MATERIAL: DIE-CAST ALUMINUM

COLOR: BLACK

MEMBRANE: MILITARY BREATHER

LENS MATERIAL: POLYCARBONATE

MOUNTING BOLT DRILL: 0.25"

ELECTRONICS: INTEGRATED EPOXY-ENCAPSULATED

HARDWARE: ALUMINUM

OPERATING TEMPERATURE: -40°F TO +140°F

PROTECTION: REVERSE POLARITY

MOUNTING: SIDE & REAR

IP RATING: IP67

SPECS & MEASUREMENTS

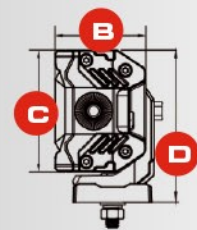
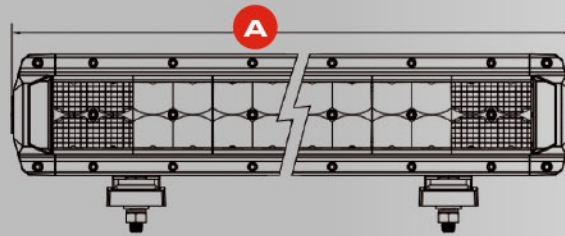

PART	A	B	C	D
HE-HDR8	8.11"	2.28"	3.07"	3.62"
HE-HDR14	14.13"	2.28"	3.07"	3.62"
HE-HDR32	32.20"	2.28"	3.07"	3.62"
HE-HDR42	42.24"	2.28"	3.07"	3.62"
HE-HDR50	50.28"	2.28"	3.07"	3.62"

DUAL ROW LED LIGHTBARS

BLACKOUT SERIES

HE-BD8

08 INCH

12 LED

★ IP67 ★
CERTIFIED

Wattage: 60W • Raw Lumens: 5040lm • Lux @ 10m: 1083 lx
Current Consumption @ 13.8V: 2.1A



HE-BD14

14 INCH

24 LED

★ IP67 ★
CERTIFIED

Wattage: 120W • Raw Lumens: 10080lm • Lux @ 10m: 3666 lx
Current Consumption @ 13.8V: 3.8A



HE-BD20

20 INCH

40 LED

★ IP67 ★
CERTIFIED

Wattage: 108W • Raw Lumens: 15120lm Lux @ 10m: 6461 lx
Current Consumption @ 13.8V: 6.0A



HE-BD22

22 INCH

40 LED

★ IP67 ★
CERTIFIED

Wattage: 200W • Raw Lumens: 16800lm • Lux @ 10m: 6461 lx
Current Consumption @ 13.8V: 6.7A



HE-BD32

32 INCH

60 LED

★ IP67 ★
CERTIFIED

Wattage: 300W • Raw Lumens: 25200lm • Lux @ 10m: 8624 lx
Current Consumption @ 13.8V: 9.3A



HE-BD42

42 INCH

80 LED

★ IP67 ★
CERTIFIED

Wattage: 400W • Raw Lumens: 33600lm • Lux @ 10m: 11500 lx
Current Consumption @ 13.8V: 13.5A



HE-BD50

50 INCH

96 LED

★ IP67 ★
CERTIFIED

Wattage: 480W • Raw Lumens: 40320lm • Lux @ 10m: 12300 lx
Current Consumption @ 13.8V: 16.1A





HYBRID



UNIVERSAL



PROTECTIVE VENT PORT

COMMON FEATURES

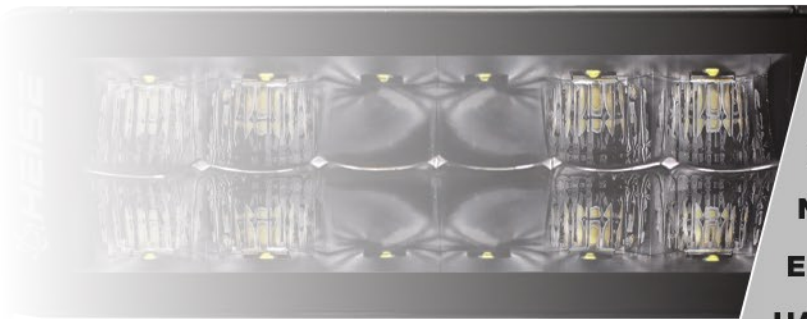

INPUT VOLTAGE: 10-30V DC

COLOR TEMPERATURE: 5700K

BEAM PATTERN: COMBO - 90° FLOOD / 8° SPOT

HOUSING MATERIAL: DIE-CAST ALUMINUM

COLOR: BLACK

MEMBRANE: PROTECTIVE VENT PORT

LENS MATERIAL: POLYCARBONATE

MOUNTING BOLT DRILL: 0.25"

ELECTRONICS: INTEGRATED EPOXY-ENCAPSULATED

HARDWARE: STAINLESS 316

OPERATING TEMPERATURE: -40°F TO +140°F

PROTECTION: REVERSE POLARITY

MOUNTING: SIDE & REAR

IP RATING: IP67

SPECS & MEASUREMENTS

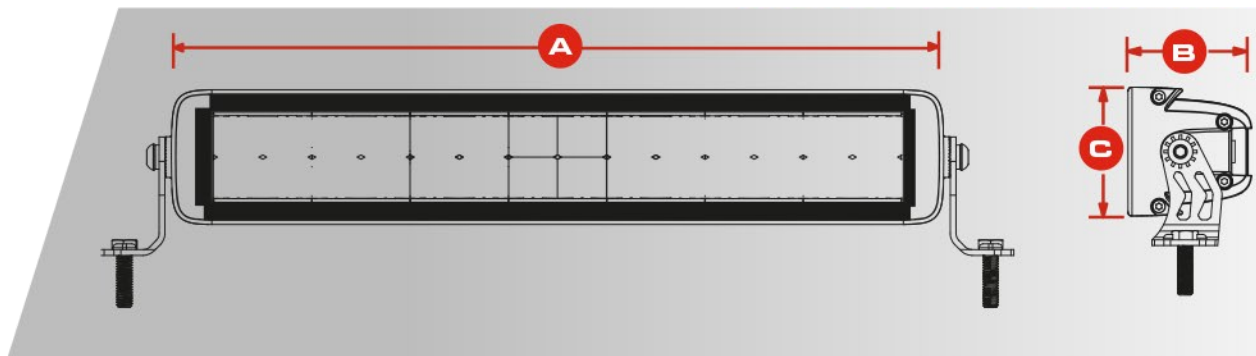

PART	A	B	C
HE-BD8	8.03"	2.64"	2.76"
HE-BD14	14.06"	2.64"	2.76"
HE-BD20	20.07"	2.64"	2.76"
HE-BD22	22.09"	2.64"	2.76"
HE-BD32	32.09"	2.64"	2.76"
HE-BD42	42.36"	2.64"	2.76"
HE-BD50	50.16"	2.64"	2.76"

CHASING LED LIGHTBARS

HEISE CONNECT
FREE APP

HE-CHASE-B8

8 INCH

18 LED

★ IP68 ★
CERTIFIED



Wattage: 16.5W • Raw Lumens: 2145lm • Lux @ 10m: 47 lx
Current Consumption @ 13.8V: 1.2A

Heise Connect chasing controller included



HE-CHASE-B12

12 INCH

36 LED

★ IP68 ★
CERTIFIED



Wattage: 33.1W • Raw Lumens: 4303lm • Lux @ 10m: 73 lx
Current Consumption @ 13.8V: 2.4A

Heise Connect chasing controller included



HE-CHASE-B22

22 INCH

60 LED

★ IP68 ★
CERTIFIED



Wattage: 67.62W • Raw Lumens: 8790lm • Lux @ 10m: 92 lx
Current Consumption @ 13.8V: 4.9A

Heise Connect chasing controller included



HE-CHASE-B32

32 INCH

90 LED

★ IP68 ★
CERTIFIED



Wattage: 82.8W • Raw Lumens: 107640lm • Lux @ 10m: 142 lx
Current Consumption @ 13.8V: 6.0A

Heise Connect chasing controller included



COMMON FEATURES



INPUT VOLTAGE: 12-24V DC

COLOR TEMPERATURE: 6000K

BEAM PATTERN: 120° SPOT

HOUSING MATERIAL: ALUMINUM

COLOR: BLACK

MEMBRANE: SEALED

LENS MATERIAL: POLYCARBONATE

MOUNTING BOLT DRILL: 0.25"

ELECTRONICS: INTEGRATED EPOXY-ENCAPSULATED

HARDWARE: STAINLESS 316

OPERATING TEMPERATURE: -40°F TO +140°F

PROTECTION: REVERSE POLARITY

MOUNTING: SIDE

IP RATING: IP68

**HEISE CONNECT
FREE APP**
for smartphones
and tablets



SPECS & MEASUREMENTS

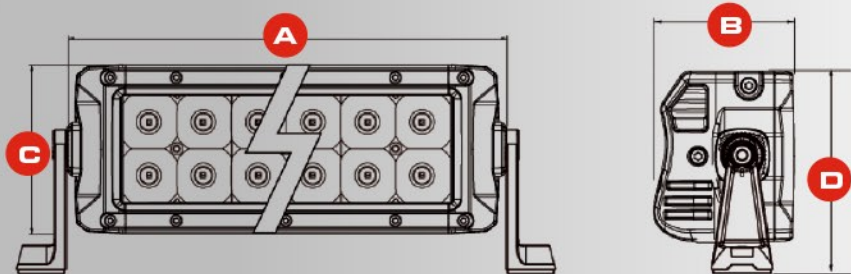

★ IP68 ★
CERTIFIED

HE-CHASE-CB

CONTROL BOX

Included with all
Chasing LED
cube lights

PART	A	B	C
HE-CHASE-B8	8.07"	3.15"	1.69"
HE-CHASE-B12	13.19"	3.15"	1.69"
HE-CHASE-B22	22.04"	3.15"	1.69"
HE-CHASE-B32	31.89"	3.15"	1.69"

INFINITE SERIES LED LIGHTBARS

HE-INFIN8

8 INCH

12 LED

★ IP67 ★
CERTIFIED



RGB LEDS

Wattage: 18W • **Raw Lumens:** 2280lm • **Lux @ 10m:** 235 lx
Current Consumption @ 13.8V: 1.3A

- HE-RGB-CB controller required (sold separately)



HE-INFIN22

22 INCH

40 LED

★ IP67 ★
CERTIFIED



RGB LEDS

Wattage: 60W • **Raw Lumens:** 7600lm • **Lux @ 10m:** 1150 lx
Current Consumption @ 13.8V: 4.34A

- HE-RGB-CB controller required (sold separately)



HE-INFIN30

30 INCH

56 LED

★ IP67 ★
CERTIFIED



RGB LEDS

Wattage: 84W • **Raw Lumens:** 10640lm • **Lux @ 10m:** 1426 lx
Current Consumption @ 13.8V: 6.1A

- HE-RGB-CB controller required (sold separately)



HE-INFIN40

40 INCH

76 LED

★ IP67 ★
CERTIFIED



RGB LEDS

Wattage: 114W • **Raw Lumens:** 14440lm • **Lux @ 10m:** 1780 lx
Current Consumption @ 13.8V: 9.5A

- HE-RGB-CB controller required (sold separately)





HYBRID



UNIVERSAL



MILITARY BREATHER
MEMBRANE

COMMON FEATURES



INPUT VOLTAGE: 10-30V DC

COLOR TEMPERATURE: 6000K

BEAM PATTERN: 8° SPOT

HOUSING MATERIAL: DIE-CAST ALUMINUM

COLOR: BLACK

MEMBRANE: MILITARY BREATHER

LENS MATERIAL: POLYCARBONATE

MOUNTING BOLT DRILL: 0.25"

ELECTRONICS: INTEGRATED EPOXY-ENCAPSULATED

HARDWARE: STAINLESS 316

OPERATING TEMPERATURE: -40°F TO +140°F

PROTECTION: REVERSE POLARITY

MOUNTING: SIDE & REAR

IP RATING: IP67

**HEISE CONNECT
FREE APP**
for smartphones
and tablets



SPECS & MEASUREMENTS

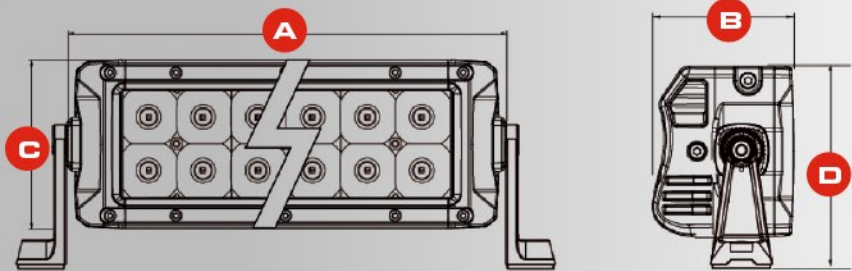

**★ IP68 ★
CERTIFIED**

HE-RGB-CB

CONTROL BOX

Required for RGB functionality
on all Infinite Series lights.
(sold separately)

PART	A	B	C	D
HE-INFIN8	8.11"	2.56"	3.09"	4.84"
HE-INFIN22	22.17"	2.56"	3.09"	4.84"
HE-INFIN30	30.20"	2.56"	3.09"	4.84"
HE-INFIN40	40.24"	2.56"	3.09"	4.84"

SINGLE ROW LED LIGHTBARS

BLACKOUT SERIES SUPERSLIMLINE SERIES

HE-B950 9.5 INCH 09 LED ★ IP67 ★ CERTIFIED

Wattage: 45W • Raw Lumens: 3780lm • Lux @ 10m: 1307 lx
Current Consumption @ 13.8V: 2.4A



HE-B2050 20.5 INCH 21 LED ★ IP67 ★ CERTIFIED

Wattage: 105W • Raw Lumens: 8820lm • Lux @ 10m: 4065 lx
Current Consumption @ 13.8V: 5.7A



HE-B3150 31.5 INCH 33 LED ★ IP67 ★ CERTIFIED

Wattage: 165W • Raw Lumens: 13860lm • Lux @ 10m: 6150 lx
Current Consumption @ 13.8V: 8.9A



HE-B3950 39.5 INCH 42 LED ★ IP67 ★ CERTIFIED

Wattage: 210W • Raw Lumens: 17640lm • Lux @ 10m: 6957 lx
Current Consumption @ 13.8V: 10.1A



HE-B5050 50.5 INCH 54 LED ★ IP67 ★ CERTIFIED

Wattage: 270W • Raw Lumens: 22680lm • Lux @ 10m: 8402 lx
Current Consumption @ 13.8V: 11.8A





COMMON FEATURES



INPUT VOLTAGE: 10-30V DC

COLOR TEMPERATURE: 5700K

BEAM PATTERN: COMBO - 90° FLOOD / 8° SPOT

HOUSING MATERIAL: DIE-CAST ALUMINUM

COLOR: BLACK

MEMBRANE: PROTECTIVE VENT PORT

LENS MATERIAL: POLYCARBONATE

MOUNTING BOLT DRILL: 0.25"

ELECTRONICS: INTEGRATED EPOXY-ENCAPSULATED

HARDWARE: STAINLESS 316

OPERATING TEMPERATURE: -40°F TO +140°F

PROTECTION: REVERSE POLARITY

MOUNTING: SIDE & REAR

IP RATING: IP67

SPECS & MEASUREMENTS

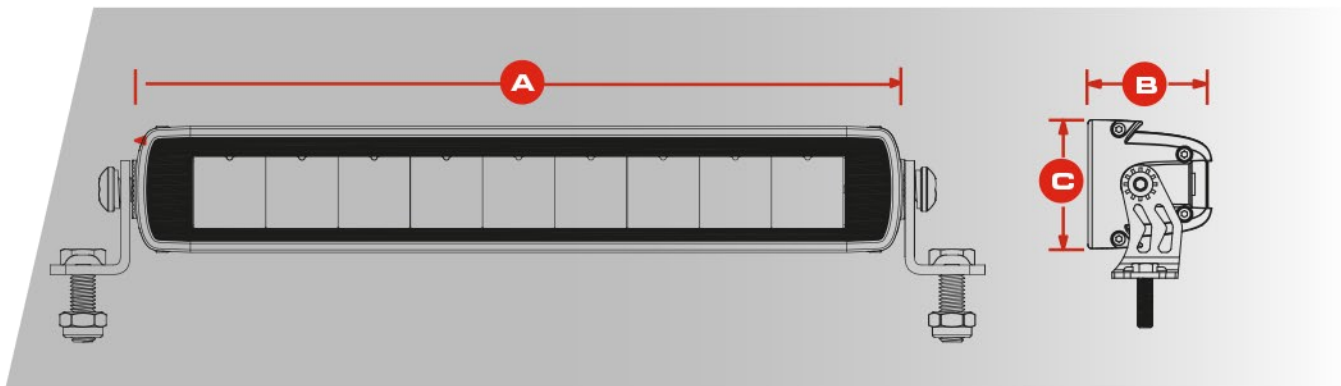

PART	A	B	C
HE-B950	9.69"	2.14"	1.57"
HE-B2050	20.55"	2.14"	1.57"
HE-B3150	31.42"	2.14"	1.57"
HE-B3950	39.57"	2.14"	1.57"
HE-B5050	50.43"	2.14"	1.57"

SINGLE ROW LED LIGHTBARS

SUPERSLIMLINE SERIES

HE-SS550 **5.5** INCH **3** LED **★ IP67 ★ CERTIFIED**

Wattage: 9W • Raw Lumens: 810lm • Lux @ 10m: 635 lx
Current Consumption @ 13.8V: 0.55A



HE-SS9 **9** INCH **6** LED **★ IP67 ★ CERTIFIED**

Wattage: 18W • Raw Lumens: 1620lm • Lux @ 10m: 930 lx
Current Consumption @ 13.8V: 1.08A



HE-SS32 **32** INCH **24** LED **★ IP67 ★ CERTIFIED**

Wattage: 72W • Raw Lumens: 6480lm • Lux @ 10m: 2900 lx
Current Consumption @ 13.8V: 4.55A



HE-SS3950 **39.5** INCH **30** LED **★ IP67 ★ CERTIFIED**

Wattage: 90W • Raw Lumens: 8100lm • Lux @ 10m: 3480 lx
Current Consumption @ 13.8V: 5.78A





HYBRID



UNIVERSAL



PROTECTIVE
VENT PORT

COMMON FEATURES



INPUT VOLTAGE: 10-30V DC

COLOR TEMPERATURE: 6000K

BEAM PATTERN: COMBO: 90° FLOOD / 8° SPOT

HOUSING MATERIAL: DIE-CAST ALUMINUM

COLOR: BLACK

MEMBRANE: PROTECTIVE VENT PORT

LENS MATERIAL: POLYCARBONATE

MOUNTING BOLT DRILL: 0.25"

ELECTRONICS: INTEGRATED EPOXY-ENCAPSULATED

HARDWARE: STAINLESS 316

OPERATING TEMPERATURE: -40°F TO +140°F

PROTECTION: REVERSE POLARITY

MOUNTING: SIDE & REAR

IP RATING: IP67

SPECS & MEASUREMENTS

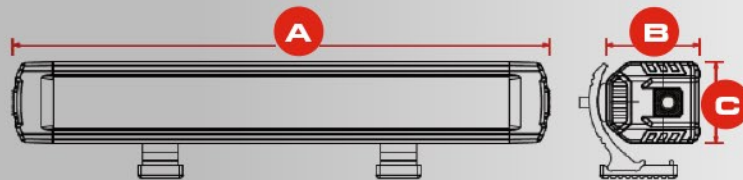

PART	A	B	C
HE-SS550	5.59"	2.05"	1.77"
HE-SS9	9.37"	2.05"	1.77"
HE-SS32	32.05"	2.05"	1.77"
HE-SS3950	39.61"	2.05"	1.77"

SINGLE ROW LED LIGHTBARS

SLIMLINE SERIES

HE-SL550 **5.5** INCH **3** LED **★ IP67 ★ CERTIFIED**

Wattage: 9W • Raw Lumens: 720lm • Lux @ 10m: 10 lx
Current Consumption @ 13.8V: 0.4A



HE-SL914 **9.25** INCH **6** LED **★ IP67 ★ CERTIFIED**

Wattage: 18W • Raw Lumens: 1440lm • Lux @ 10m: 22 lx
Current Consumption @ 13.8V: 0.9A



HE-SL2014 **20.25** INCH **15** LED **★ IP67 ★ CERTIFIED**

Wattage: 45W • Raw Lumens: 3600lm • Lux @ 10m: 1280 lx
Current Consumption @ 13.8V: 2.4A



HE-SL32 **32** INCH **24** LED **★ IP67 ★ CERTIFIED**

Wattage: 72W • Raw Lumens: 5760lm • Lux @ 10m: 2200 lx
Current Consumption @ 13.8V: 4.0A



HE-SL3912 **39.5** INCH **30** LED **★ IP67 ★ CERTIFIED**

Wattage: 90W • Raw Lumens: 7200lm • Lux @ 10m: 2920 lx
Current Consumption @ 13.8V: 4.9A





HYBRID



UNIVERSAL



PROTECTIVE
VENT PORT

COMMON FEATURES



INPUT VOLTAGE: 10-30V DC

COLOR TEMPERATURE: 6000K

BEAM PATTERN: COMBO: 90° FLOOD / 8° SPOT

HOUSING MATERIAL: DIE-CAST ALUMINUM

COLOR: BLACK

MEMBRANE: PROTECTIVE VENT PORT

LENS MATERIAL: POLYCARBONATE

MOUNTING BOLT DRILL: 0.25"

ELECTRONICS: INTEGRATED EPOXY-ENCAPSULATED

HARDWARE: STAINLESS 316

OPERATING TEMPERATURE: -40°F TO +140°F

PROTECTION: REVERSE POLARITY

MOUNTING: SIDE & REAR

IP RATING: IP67

SPECS & MEASUREMENTS

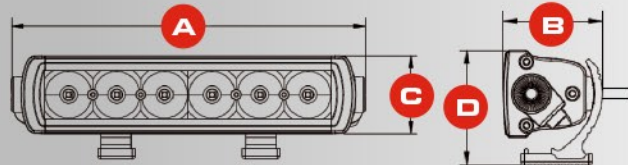

PART	A	B	C	D
HE-SL550	5.51"	2.32"	2.05"	2.72"
HE-SL914	9.29"	2.32"	2.05"	2.72"
HE-SL2014	20.63"	2.32"	2.05"	2.72"
HE-SL32	31.97"	2.32"	2.05"	2.72"
HE-SL3912	39.53"	2.32"	2.05"	2.72"

SINGLE ROW EDGELESS

SLIMLINE SERIES

HE-TSL20

20 INCH

3 LED

★ IP67 ★
CERTIFIED



Wattage: 64W • **Raw Lumens:** 5309lm • **Lux @10m:** 1950 lx
Current Consumption @ 13.8V: 5.33A • **IP Rating:** IP67

The Edgeless Slimline lightbar offers an 8-degree spot beam pattern that is more focused than previous models, with a higher 5,309-lumen output. A modern, streamlined appearance is void of the traditional look of screws on the front of the lightbar. This style doesn't sacrifice its durability or IP rating, as it features Heise's proprietary torture-tested heavy-duty construction with a virtually unbreakable polycarbonate lens and Integrated epoxy-encapsulated electronics. It is rated IP67 with a military breather port that allows moisture to escape.



MILITARY BREATHER
MEMBRANE

FEATURES

INPUT VOLTAGE: 10-30V DC

COLOR TEMPERATURE: 6000K

BEAM PATTERN: 8° SPOT

HOUSING MATERIAL:

DIE-CAST ALUMINUM

COLOR: BLACK

MEMBRANE: MILITARY BREATHER

LENS MATERIAL: POLYCARBONATE

MOUNTING BOLT DRILL: 0.25"

ELECTRONICS:

INTEGRATED EPOXY-ENCAPSULATED

HARDWARE: STAINLESS 316

OPERATING TEMPERATURE:

-40°F TO +140°F

PROTECTION: REVERSE POLARITY

MOUNTING: SIDE ONLY

SPECS & MEASUREMENTS



PART	A	B	C
HE-TSL20	19.88"	2.05"	1.52"

DUAL ROW LED LIGHTBARS

HE-DR14 **14** INCH **24** LED **★ IP68 ★ CERTIFIED**

Wattage: 72W • Raw Lumens: 5760lm • Lux @ 10m: 466 lx
Current Consumption @ 13.8V: 3.7A



HE-DR22 **22** INCH **40** LED **★ IP67 ★ CERTIFIED**

Wattage: 120W • Raw Lumens: 9600lm • Lux @ 10m: 655 lx
Current Consumption @ 13.8V: 6.3A



HYBRID



UNIVERSAL



Polycarbonate LENS

COMMON FEATURES



- INPUT VOLTAGE:** 10-30V DC
- COLOR TEMPERATURE:** 6000K
- BEAM PATTERN:** COMBO:
90° FLOOD / 8° SPOT
- HOUSING MATERIAL:**
DIE-CAST ALUMINUM
- COLOR:** BLACK
- MEMBRANE:** PROTECTIVE VENT PORT
- LENS MATERIAL:** POLYCARBONATE
- MOUNTING BOLT DRILL:** 0.25"
- ELECTRONICS:**
INTEGRATED EPOXY-ENCAPSULATED
- HARDWARE:** STAINLESS 316
- OPERATING TEMPERATURE:**
-40°F TO +140°F
- PROTECTION:** REVERSE POLARITY
- MOUNTING:** SIDE ONLY

SPECS & MEASUREMENTS

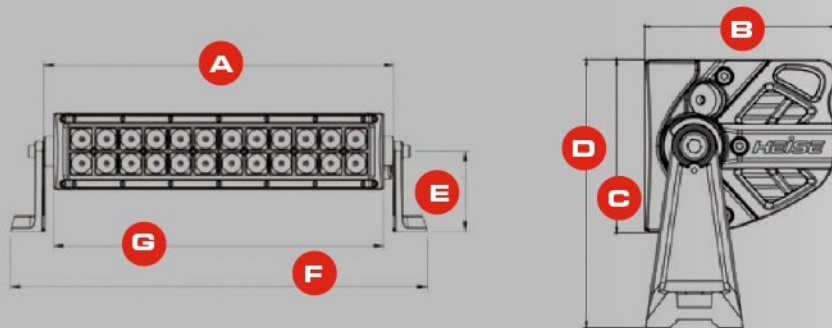

PART	A	B	C	D	E	F	G
HE-DR14	14.09"	3.41"	3.09"	4.8"	3.23"	16.69"	13.27"
HE-DR22	22.13"	3.41"	3.09"	4.8"	3.23"	24.72"	21.3"

SWITCHES



HE-SWP8 8 GANG SWITCH PANEL

SPECS

- Input Voltage: 12V-24V
- Power Handling: 600-1200W
- Maximum Current: 60A
- Panel Material: Die-cast aluminum
- Switched or momentary operation
- Control Box Material: Die-cast aluminum
- Control Box Cover: ABS plastic
- Operating Temperature: - 40°F to 302°F
- Panel Size: 4.53"x0.59"x2.60"
- Circuit Box Size: 7.48"x1.34"x4.13"
- 50 custom decals



HE-SWP8C 8 GANG FLUSH MOUNT SWITCH PANEL CASE

SPECS

- Fits HE-SWP8 switch panel
- Switch panel screws securely to the case box
- Included snap-on trim plate for a clean installation
- Cut template and mounting hardware included



HE-BRS 5 PACK BLUE ROUND ROCKER SWITCH

Illuminates blue

HE-RRS 5 PACK RED ROUND ROCKER SWITCH

Illuminates red

- 20 amp
- Rubber cover helps protect switch from dust and water intrusion



WIRING HARNESSES

HE-SLWH2

1 LAMP

UNIVERSAL

ATP WIRING HARNESS & SWITCH KIT

- Universal wiring harness & switch kit (for 1 lamp, ATP connector)
- Universal plug-n-play wiring harness with On/Off rocker switch
- 12V DC relay
- 30A fuse
- Use with 1 Heise light 160 watts or more
- 9' switch cable
- 9' light cable



HE-SLWH1

1 LAMP

UNIVERSAL

DT WIRING HARNESS & SWITCH KIT

- Universal wiring harness & switch kit (for 1 lamp, DT connector)
- Universal plug-n-play wiring harness with On/Off rocker switch
- 12V DC relay
- 30A fuse
- Use with 1 Heise light 150 watts or less
- 9' switch cable
- 9' light cable



HE-DLWH1

2 LAMP

UNIVERSAL

WIRING HARNESS & SWITCH KIT

- Universal plug-n-play wiring harness & switch with On/Off rocker switch
- 12V DC relay
- 30A fuse
- 2-pin DT connectors for 2 lamps
- Water-resistant fuse holder
- Set includes wiring harness & switch
- Easy installation
- Use with 2 Heise lights 150 watts each or less
- 9' switch cable
- 9' light cable



HE-DTSPLIT

150 WATT

CONNECTOR

- Connects two lights into one connector to make wiring easier and neater
- Use 2 lights or lightbars with 150 watts total or less and add our Heise wiring harness (HE-SLWH1 - sold separately) for a plug-n-play solution
- Length end to end: 22 inches



LIGHTBAR CONNECTORS

HE-ATPIGTAIL 10 PACK WITH WIRE **ATP CONNECTORS**

- For lightbars 150-300 watts
- 12" in length



HE-ATP3PIGTAIL 10 PACK WITH WIRE **ATP CONNECTORS**

- For lightbars 180-300 watts
- 12" in length



HE-DTPIGTAIL 10 PACK WITH WIRE **DT CONNECTORS**

- For lightbars up to 150 watts
- 12" in length



HE-DTPLUG 10 PACK WITH WIRE **DT CONNECTORS**

- For lightbars up to 150 watts
- 12" in length



HE-DT3PIGTAIL 10 PACK WITH WIRE **DT CONNECTORS**

- For lightbars up to 180 watts
- 12" in length



HE-DT3PLUG 10 PACK WITH WIRE **DT CONNECTORS**

- For lightbars up to 180 watts
- 12" in length



REPLACEMENT BRACKETS

HE-RMBK REPLACEMENT **MOUNTING BRACKETS**

- Replacement mounting brackets and hardware for INFIN, HDR, DR, DRC, BDR, BDRC, SR and SRC Series Heise lightbars



HE-RSLBK REPLACEMENT **MOUNTING BRACKETS**

- Replacement mounting brackets and hardware for SLIMLINE Series Heise lightbars





BRACKETS & MOUNTS



BRONCO 2021-UP*

HE-BRK-FD1 ROOF LIGHTBAR BRACKET

- Fits Heise 50"-52" lightbars with rear mount brackets
- Plastic covers conceal the bracket and OE mounting bolts
- Black powder-coated brackets



BRONCO 2021-UP*

HE-BRK-FD2 ROOF TRAC LIGHT BRACKET

- Fits Heise lightbars, cubes, and driving lights
- Slotted hole across the top of the bracket offers flexible mounting points
- Hide your wiring in the back channel
- Plastic covers conceal the bracket and OE mounting bolts
- Black powder-coated brackets



BRONCO 2021-UP*

HE-BRK-FD3 BUMPER LIGHTBAR BRACKET

- Fits Heise 42" lightbars on the front bumper (metal bumpers only)
- Wiring harness included for easy installation with Bronco Auxiliary switch wiring
- Black powder-coated brackets



BRONCO 2021-UP*

HE-BRK-FD4 FOG LIGHT BRACKETS

- Fits up to three Heise cubes or one HE-B950 lightbar per bracket
- Uses OE mounting locations
- Wiring harness included for easy installation with Bronco Auxiliary switch wiring



BRACKETS FITS JEEP JL + GLADIATOR JT

JL 2018-UP*
JT 2020-UP*

JP-JFOG FOG LIGHT BRACKET

- Fits: 2018-UP* Jeep Wrangler JL Rubicon
2020-UP* Jeep Gladiator Sport



JL 2018-UP*
JT 2020-UP*

JP-JFOG2 FOG LIGHT BRACKET

- Fits: 2018-UP* Jeep Wrangler JL Sport
2020-UP* Jeep Gladiator Sport
- Mounts with factory hardware
- Coverts any JP-xxx 4" fog light to a direct bolt-on
- ABS constructed brackets are marked left, right and top for easier orientation



JL 2018-UP*
JT 2020-UP*

JP-JLB7 7" LED HEADLIGHT ADAPTER

- Fits: 2018-UP* Jeep Wrangler JL Sport
2020-UP* Jeep Gladiator Sport
- Includes factory to H4 wiring adapters
- Solid steel construction
- 3 points of beam adjustment
- Gaskets included
- Sold as a set of 2 brackets with 2 harnesses
- Headlights sold separately



JL 2018-UP*
JT 2020-UP*

JP-JLAPB PILLAR LIGHT BRACKET

- Designed for 50" straight lightbar
- 2 post mounts for cubes or work lights
- Anti-sway stabilization hardware



JL 2018-UP*
JT 2020-UP*

JP-JLPMLB POST MOUNT BRACKET

- Fits a cube, work or driving light
- Mount cubes on top and sides
- 6 different mounting locations



5-GAUGE, POWDER-COATED STEEL

INCLUDES: GASKET AND MOUNTING HARDWARE

BRACKETS FITS JK JEEP WRANGLER

JK 2007-2018
JT 2020-UP*

JP-JFOG FOG LIGHT BRACKET

- Fits: 2009-2018 Jeep Wrangler JK Hard Rock, Rubicon X, 10th Anniversary Edition



JK 2007-2018

JP-JKAPB A-PILLAR BRACKET

- Designed for 50" straight lightbar



7-GAUGE, POWDER-COATED STEEL

INCLUDES: GASKET AND MOUNTING HARDWARE

UNIVERSAL MOUNTS

HE-UVMM MAGNET MOUNT

- Ultra-strong magnetic mount
- Mount 1 light per bracket or use set to mount a lightbar











HE-UVHM HOOD MOUNT

- No drill compression mount
- Mount 1 light per bracket or use set to mount a slim lightbar
- Rubber pad built onto bracket to protect vehicle's paint



ROLL BAR MOUNTS

<p>HE-RBM75</p>  <p>.75 INCH</p> <p>2 PACK</p>	<p>HE-RBM1</p>  <p>1 INCH</p> <p>2 PACK</p>	<p>HE-RBM125</p>  <p>1.25 INCH</p> <p>2 PACK</p>
<p>HE-RBM150</p>  <p>1.5 INCH</p> <p>2 PACK</p>	<p>HE-RBM175</p>  <p>1.75 INCH</p> <p>2 PACK</p>	<p>HE-RBM2</p>  <p>2 INCH</p> <p>2 PACK</p>
<p>HE-RBM225</p>  <p>2.25 INCH</p> <p>2 PACK</p>	<p>HE-RBM250</p>  <p>2.5 INCH</p> <p>2 PACK</p>	<p>HE-RBM3</p>  <p>3 INCH</p> <p>2 PACK</p>

BULK 10 PACK

<p>HE-RBMB ROLL BAR MOUNT BODY</p>	<p>HE-RBC150 1.5" ROLL BAR CLAMPS</p>
<p>HE-RBC1 1" ROLL BAR CLAMPS</p>	<p>HE-RBC2 2" ROLL BAR CLAMPS</p>
<p>HE-RBC125 1.25" ROLL BAR CLAMPS</p>	

BLACK PLATED ALUMINUM TO BE ATTRACTIVE AND STRONG
USE WITH LIGHTBARS, DRIVING AND WORK LIGHTS
RUBBER GASKET INCLUDED TO PROTECT THE ROLL BAR
ALLEN KEYS INCLUDED



CUBE LIGHTS

CUBE LIGHTS



HIGH OUTPUT CUBE LED LIGHTS

HE-HCL140

4 INCH

15 LED

1 LIGHT

★ IP67 ★
CERTIFIED

HE-HCL1402PK

4 INCH

15 LED

2 PACK

★ IP67 ★
CERTIFIED

Wattage: 30W • Raw Lumens: 2850lm • Lux @ 10m: 122 lx
Beam Pattern: 140° Flood/15° Spot • Current Consumption @ 13.8V: 2.2A

Heise HE-DLWH1 dual light wiring harness included

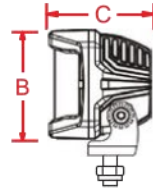

B: 3.07" C: 2.87"



BLACKOUT
SERIES

HE-BC1402PK

3 INCH

10 LED

2 PACK

NEW

Wattage: 70W • Raw Lumens: 3754lm • Lux @ 10m: 7611 lx
Beam Pattern: 140° Flood/15° Spot • Current Consumption @ 13.8V: 2.88A



B: 3.03" C: 2.95"



HIGH OUTPUT CUBE LED LIGHTS

BLACKOUT SERIES

HE-BCF32PK **3** INCH **4** LED **2** PACK **★ IP67 ★ CERTIFIED**

Wattage: 40W • **Raw Lumens:** 4800lm • **Lux @ 10m:** 28 lx
Beam Pattern: 100° Flood • **Current Consumption @ 13.8V:** 2.9A

Values are for a single light

Heise HE-DLWH1 dual light wiring harness included

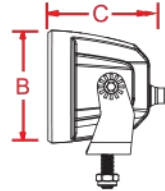

B: 2.95" C: 2.66"



HE-BCS32PK **3** INCH **4** LED **2** PACK **★ IP67 ★ CERTIFIED**

Wattage: 40W • **Raw Lumens:** 4800lm • **Lux @ 10m:** 736 lx
Beam Pattern: 20° Spot • **Current Consumption @ 13.8V:** 2.9A

Values are for a single light

Heise HE-DLWH1 dual light wiring harness included

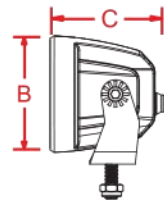

B: 2.95" C: 2.66"



HE-BCF2PK **2.5** INCH **4** LED **2** PACK **★ IP67 ★ CERTIFIED**

Wattage: 20W • **Raw Lumens:** 1920lm • **Lux @ 10m:** 35 lx
Beam Pattern: 90° Flood • **Current Consumption @ 13.8V:** 1.3A

Values are for a single light

Heise HE-DLWH1 dual light wiring harness included

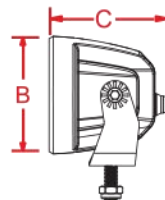

B: 2.53" C: 2.35"



HE-BCS2PK **2.5** INCH **4** LED **2** PACK **★ IP67 ★ CERTIFIED**

Wattage: 20W • **Raw Lumens:** 1920lm • **Lux @ 10m:** 635 lx
Beam Pattern: 10° Spot • **Current Consumption @ 13.8V:** 1.3A

Values are for a single light

Heise HE-DLWH1 dual light wiring harness included

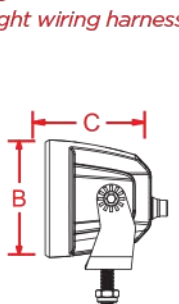

B: 2.53" C: 2.35"



HIGH OUTPUT CUBE LED LIGHTS

BLACKOUT
SERIES

HE-FMBCF

3.5 INCH

4 LED

**★ IP67 ★
CERTIFIED**

Wattage: 40W • **Raw Lumens:** 4800lm • **Lux @ 10m:** 28 lx
Beam Pattern: 110° Flood • **Current Consumption @ 13.8V:** 2.9A

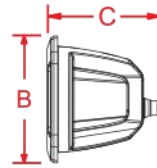

B: 3.5" C: 3"

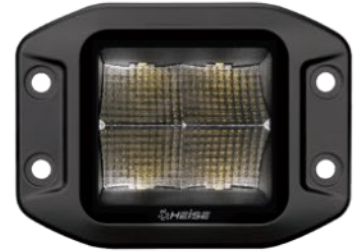

HE-FMBCS

3.5 INCH

4 LED

**★ IP67 ★
CERTIFIED**

Wattage: 40W • **Raw Lumens:** 4800lm • **Lux @ 10m:** 736 lx
Beam Pattern: 20° Spot • **Current Consumption @ 13.8V:** 2.9A

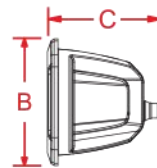

B: 3.5" C: 3"



COMMON FEATURES



PIGTAIL

Included with all
high output
cube LED lights

INPUT VOLTAGE: 12-24V

COLOR TEMPERATURE: 5700K

HOUSING MATERIAL: DIE-CAST ALUMINUM

COLOR: BLACK

LENS MATERIAL: POLYCARBONATE

ELECTRONICS: INTEGRATED EPOXY-ENCAPSULATED

HARDWARE: STAINLESS 316

OPERATING TEMPERATURE: -40°F TO +140°F

PROTECTION: REVERSE POLARITY

IP RATING: IP67



CHASING LED LIGHTS NEW

HE-CHASE-CLKT

3 INCH

32 LED

2 PACK

**★ IP67 ★
CERTIFIED**



Wattage: 22W • **Raw Lumens:** 2860lm • **Lux @ 10m:** 20 lx
Beam Pattern: 120° Spot • **Current Consumption @ 13.8V:** 1.6A

Heise Connect chasing controller included

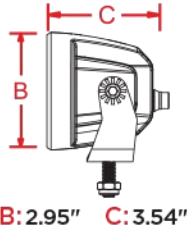

B: 2.95" **C:** 3.54"



HE-CHASE-FCLKT

3 INCH

32 LED

2 PACK

**★ IP67 ★
CERTIFIED**



Wattage: 22W • **Raw Lumens:** 2860lm • **Lux @ 10m:** 20 lx
Beam Pattern: 120° Spot • **Current Consumption @ 13.8V:** 1.6A

Heise Connect chasing controller included

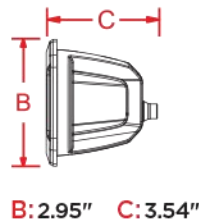

B: 2.95" **C:** 3.54"



**HEISE CONNECT
FREE APP**
for smartphones and tablets



**★ IP68 ★
CERTIFIED**



HE-CHASE-CB

CONTROL BOX

Included with all
Chasing LED
cube lights

COMMON FEATURES

INPUT VOLTAGE: 9-36V DC

COLOR TEMPERATURE: 6000K

BEAM PATTERN: 120° SPOT

HOUSING MATERIAL: DIE-CAST ALUMINUM

COLOR: BLACK

LENS MATERIAL: POLYCARBONATE

MOUNTING BRACKET: STAINLESS STEEL

ELECTRONICS: INTEGRATED EPOXY-ENCAPSULATED

HARDWARE: ALUMINUM

OPERATING TEMPERATURE: -40°F TO +140°F

PROTECTION: REVERSE POLARITY

IP RATING: IP67

INFINITE CUBE LED LIGHTS

HE-FM1CL2

5 INCH

8 LED

**★ IP67 ★
CERTIFIED**



RGB LEDS

Wattage: 11.5W • **Raw Lumens:** 1080lm • **Lux @ 10m:** 170 lx
Current Consumption @ 13.8V: 0.83A

• HE-RGB-CB controller required (sold separately)

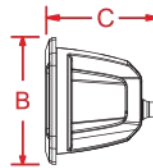

B: 4.8" **C:** 3.6"



HE-ICL2

3 INCH

4 LED

**★ IP67 ★
CERTIFIED**



RGB LEDS

HE-ICL2PK

3 INCH

4 LED

2 PACK

**★ IP67 ★
CERTIFIED**

Wattage: 13W • **Raw Lumens:** 1080lm • **Lux @ 10m:** 411 lx
Current Consumption @ 13.8V: 0.9A

• HE-RGB-CB controller required (sold separately)
Heise HE-DLWH1 dual light wiring harness included

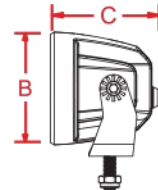

B: 3.43" **C:** 3.22"



**HEISE CONNECT
FREE APP**
for smartphones and tablets



**★ IP68 ★
CERTIFIED**



HE-RGB-CB

CONTROL BOX

Required for RGB functionality
on all Infinite Series lights.
(sold separately)

COMMON FEATURES

INPUT VOLTAGE: 10-30V DC

COLOR TEMPERATURE: 6000K

BEAM PATTERN: 8° SPOT

HOUSING MATERIAL: DIE-CAST ALUMINUM

COLOR: BLACK

LENS MATERIAL: POLYCARBONATE

MOUNTING BRACKET: STAINLESS STEEL

ELECTRONICS: INTEGRATED EPOXY-ENCAPSULATED

HARDWARE: STAINLESS 316

OPERATING TEMPERATURE: -40°F TO +140°F

PROTECTION: REVERSE POLARITY

IP RATING: IP67

CUBE LED LIGHTS & COVER

HE-CL22PK

3 INCH

4 LED

2 PACK

★ IP68 ★
CERTIFIED

Wattage: 12W • Raw Lumens: 960lm • Lux @ 10m: 17 lx
Beam Pattern: 90° Flood • Current Consumption @ 13.8V: 0.9A
Color Temperature: 6000K

Heise HE-DLWH1 dual light wiring harness included

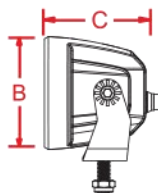

B: 3.42" C: 3.22"



HE-CL3SA

3 INCH

6 LED

★ IP68 ★
CERTIFIED

Wattage: 18W • Raw Lumens: 1440lm • Lux @ 10m: 104 lx
Beam Pattern: 5° Spot • Current Consumption @ 13.8V: 1.2A
Color Temperature: 3500K

• Amber color for dusty/rainy conditions

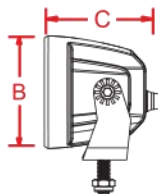

B: 3.42" C: 3.22"



HE-CLLA

CUBE

PROTECTIVE LENS COVER

AMBER

- Polycarbonate protective lens
 - Use with HE-CL22PK, HE-ICL2, and HE-ICL22PK
- NOTE: Not for use with the high output cubes



COMMON FEATURES

INPUT VOLTAGE: 10-30V DC

HOUSING MATERIAL: DIE-CAST ALUMINUM

COLOR: BLACK

LENS MATERIAL: POLYCARBONATE

MOUNTING BRACKET: STAINLESS STEEL

ELECTRONICS: INTEGRATED EPOXY-ENCAPSULATED

HARDWARE: STAINLESS 316

OPERATING TEMPERATURE: -40°F TO +140°F

PROTECTION: REVERSE POLARITY

IP RATING: IP68



DRIVING LIGHTS



DRIVING LIGHTS

DRIVING LED LIGHTS

BLACKOUT
SERIES

HE-BL1

6 INCH

6 LED

★ IP67 ★
CERTIFIED

Wattage: 30W • **Raw Lumens:** 2880lm • **Lux @ 10m:** 854 lx
Current Consumption @ 13.8V: 1.8A • **Color Temperature:** 5700K



6.18"W x 1.96"H x 2.36"D

HE-FMBL1

7.75 INCH

6 LED

FLUSH MOUNT

★ IP67 ★
CERTIFIED

Wattage: 30W • **Raw Lumens:** 2880lm • **Lux @ 10m:** 854 lx
Current Consumption @ 13.8V: 1.8A • **Color Temperature:** 5700K



7.72"W x 2.43"H x 2.07"D

COMMON FEATURES

INPUT VOLTAGE: 10-30V DC

COLOR TEMPERATURE: 6000K

BEAM PATTERN: 15° SPOT

HOUSING MATERIAL: DIE-CAST ALUMINUM

COLOR: BLACK

LENS MATERIAL: POLYCARBONATE

ELECTRONICS: INTEGRATED EPOXY-ENCAPSULATED

HARDWARE: STAINLESS 316

OPERATING TEMPERATURE: -40°F TO +140°F

PROTECTION: REVERSE POLARITY

IP RATING: IP67

DRIVING LED LIGHTS

HE-DL1

6 LED

SINGLE ROW

★ IP67 ★
CERTIFIED

Wattage: 18W • Raw Lumens: 1440lm • Lux @ 10m: 260 lx

Current Consumption @ 13.8V: 0.9A • Mounting Bracket: Black Powder-Coated Steel

Hole Dimensions: Mounting Bolt Drill .25"



6.25"W x 1.75"H

HE-FMDL1

6 LED

FLUSH MOUNT

★ IP67 ★
CERTIFIED

Wattage: 18W • Raw Lumens: 1440lm • Lux @ 10m: 260 lx

Current Consumption @ 13.8V: 0.9A • Mounting Bracket: Stainless steel

Hole Dimensions: Mounting Bracket to Mounting Hole is 7"

Gasket and cut out template included



7.37"W x 2.5"H

COMMON FEATURES

INPUT VOLTAGE: 10-30V DC

COLOR TEMPERATURE: 6000K

BEAM PATTERN: 25° SPOT

HOUSING MATERIAL: DIE-CAST ALUMINUM

COLOR: BLACK

LENS MATERIAL: POLYCARBONATE

ELECTRONICS: INTEGRATED EPOXY-ENCAPSULATED

HARDWARE: STAINLESS 316

OPERATING TEMPERATURE: -40°F TO +140°F

PROTECTION: REVERSE POLARITY

IP RATING: IP67



EDGELESS DRIVING LED LIGHTS

HE-EL2

4 INCH

9 LED

**★ IP67 ★
CERTIFIED**

Wattage: 45W • **Raw Lumens:** 5400lm • **Lux @ 10m:** 1340 lx
Current Consumption @ 13.8V: 27A • **Beam Pattern:** 8° Spot
Color Temperature: 6000K



4.72"W x 4.13"H x 2.85"D

UPDATED

HE-EL3

7 INCH

16 LED

**★ IP68 ★
CERTIFIED**

Wattage: 80W • **Raw Lumens:** 6720lm • **Lux @ 10m:** 1075 lx
Current Consumption @ 13.8V: 5.3A • **Beam Pattern:** 10° Spot
Color Temperature: 6000K

Now compatible with HE-SLWH1 wiring harness



7.56"W x 7.67"H x 3.08"D

UPDATED

HE-EL4

9 INCH

34 LED

**★ IP68 ★
CERTIFIED**

Wattage: 170W • **Raw Lumens:** 14280lm • **Lux @ 10m:** 1500 lx
Current Consumption @ 13.8V: 11.34A • **Beam Pattern:** 10° Spot
Color Temperature: 6000K

Now compatible with HE-SLWH1 wiring harness



9.37"W x 9.81"H x 3.41"D

ROUND DRIVING LED LIGHTS

HE-DL12 **2** INCH **1** LED **★ IP67 ★ CERTIFIED**

Wattage: 10W • **Raw Lumens:** 600lm • **Lux @ 10m:** 10 lx
Current Consumption @ 13.8V: 0.4A • **Beam Pattern:** 60° Flood
Mounting Bracket: Stainless Steel • **Hole Dimensions:** Mounting Bolt Drill - 0.25"



2.25"W x 2.5"H x 3"D

HE-DL2 **3.5** INCH **6** LED **★ IP67 ★ CERTIFIED**

Wattage: 18W • **Raw Lumens:** 1440lm • **Lux @ 10m:** 185 lx
Current Consumption @ 13.8V: 0.4A • **Beam Pattern:** 8° Spot
Membrane: Protective Vent Port • **Mounting Bracket:** Black Powder-Coated Steel
Hole Dimensions: Mounting Bolt Drill - 0.25"



3.50"W x 3.75"H x 2.375"D

HE-DL3 **5** INCH **8** LED **★ IP67 ★ CERTIFIED**

Wattage: 24W • **Raw Lumens:** 1920lm • **Lux @ 10m:** 570 lx
Current Consumption @ 13.8V: 1.3A • **Beam Pattern:** 26° Spot
Membrane: Protective Vent Port • **Mounting Bracket:** Black Powder-Coated Steel
Hole Dimensions: Mounting Bolt Drill - 0.375"



5"W x 6.75"H x 2"D

COMMON FEATURES

INPUT VOLTAGE: 10-30V DC

COLOR TEMPERATURE: 6000K

HOUSING MATERIAL: DIE-CAST ALUMINUM

COLOR: BLACK

LENS MATERIAL: POLYCARBONATE

ELECTRONICS: INTEGRATED EPOXY-ENCAPSULATED

HARDWARE: STAINLESS 316

OPERATING TEMPERATURE: -40°F TO +140°F

PROTECTION: REVERSE POLARITY

IP RATING: IP67

WORK LED LIGHTS

HE-WL1

3.625x2 INCH

33 LED

★ IP68 ★
CERTIFIED

Wattage: 60W • Raw Lumens: 726lm
Current Consumption @ 13.8V: 0.3A • Beam Pattern: 120° Flood
Lens Design: Unique Waffle



3.75"W x 3"H x .75"D

HE-WL2

3.625x1.75 INCH

2 LED

★ IP68 ★
CERTIFIED

Wattage: 10W • Raw Lumens: 800lm
Current Consumption @ 13.8V: 0.4A • Beam Pattern: 90° Flood



3.50"W x 2.50"H x 2.50"D

COMMON FEATURES

INPUT VOLTAGE: 10-30V DC

COLOR TEMPERATURE: 6000K

HOUSING MATERIAL: DIE-CAST ALUMINUM

COLOR: BLACK

LENS MATERIAL: POLYCARBONATE

MOUNTING BRACKET: DIE-CAST ALUMINUM

HOLE DIMENSIONS: MOUNTING BOLT DRILL - .25"

ELECTRONICS: INTEGRATED EPOXY-ENCAPSULATED

HARDWARE: STAINLESS 316

PROTECTION: REVERSE POLARITY

IP RATING: IP68



WORK LED LIGHTS

HE-WLAF

6 INCH

52 LED

★ IP68 ★
CERTIFIED

Wattage: 19W • Raw Lumens: 2296lm • Lux @ 10m: 961 lx
Current Consumption @ 13.8V: 1.34A • Beam Pattern: 120° Flood
Color Temperature: 6000K



.9"W x 1.85"H x 1.56"D

UPDATED

HE-WL4H

4.3 INCH

12 LED

HEATED

★ IP67 ★
CERTIFIED

Wattage: 60W • Raw Lumens: 9600lm • Lux @ 10m: 88 lx
Light Current Consumption @ 13.8V: 3.77A • Heater Current Consumption @ 13.8V: 1.23A
Beam Pattern: 75° Flood • Color Temperature: 6000K

- Heated feature prevents snow and frost from covering the light and reducing visibility

Now compatible with HE-SLWH1 wiring harness



5.17"W x 4.64"H x 2.91"D

HE-WL5

5 INCH

12 LED

★ IP67 ★
CERTIFIED

Wattage: 120W • Raw Lumens: 14400lm • Lux @ 10m: 1320 lx
Current Consumption @ 13.8V: 7.8A • Beam Pattern: 20° Spot
Color Temperature: 6000K



5.08"W x 5.87"H x 2.89"D

COMMON FEATURES

INPUT VOLTAGE: 12-24V

HOUSING MATERIAL: DIE-CAST ALUMINUM

COLOR: BLACK

LENS MATERIAL: POLYCARBONATE

ELECTRONICS: INTEGRATED EPOXY-ENCAPSULATED

HARDWARE: STAINLESS 316

OPERATING TEMPERATURE: -40°F TO +140°F

PROTECTION: REVERSE POLARITY



RGB / ACCENT
LIGHTS

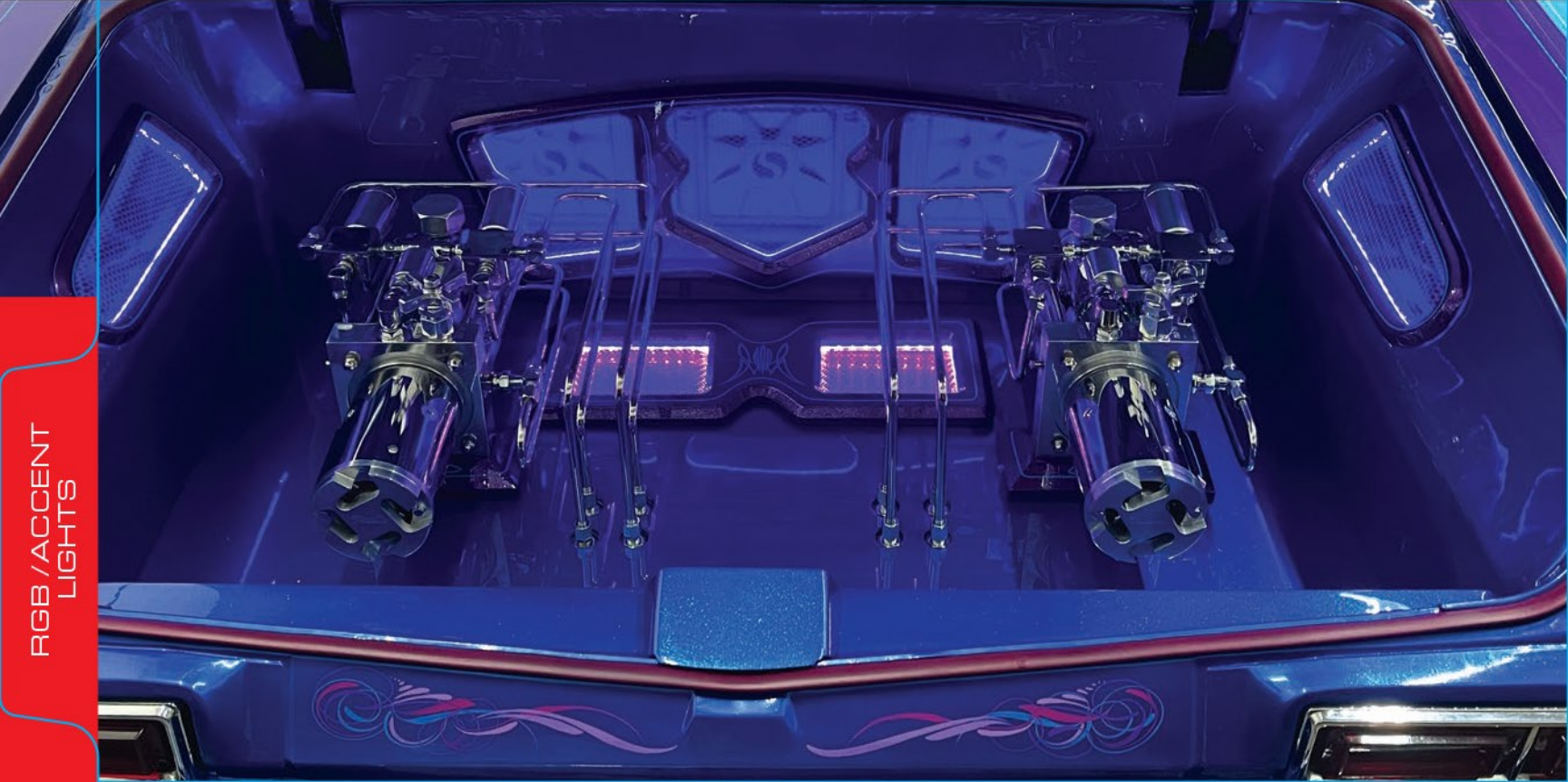

RGB / ACCENT LIGHTS

Upgrade Your Lighting. Anytime. Anywhere.



HE-CHASE-CB

HEISE CONNECT CONTROLLER

- Addressable LED controller
- 170+ color changing patterns
- Turn signal function (both left and right)
- Brake function
- DIY pattern function
- Music sync function
- App controlled (Heise Connect) on smartphones and tablets
- RF card remote included
- Max load 10A
- Water-resistant Heise connector
- Chasing products are not compatible with other RGB or RGBW products

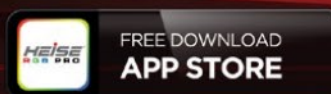

Download it FREE



EXPANDABLE CHASING LED WHEEL RINGS

HE-CHASE-WS

EXPANDABLE WHEEL RINGS - 11"-14" W/ CHASING LEDS & CONTROLLER

- 4 aluminum wheel rings, expandable from 11" to 14" diameter
- Adjusts in 0.25" diameter increments
- Cutable LED strips for inside and outside of ring
- Includes thread locking adhesive plus caps and silicone to seal LED strips
- 3M double-sided backing on LED strips
- Addressable LEDs
- All anodized aluminum and stainless-steel hardware included for long-lasting installation
- Backbone harness for left and right side included
- IP68 rating
- Option to turn lights red when braking, yellow for turn signals with the included connect controller
- NOTE: Vehicles that have a wheel base over 144 inches, will need extension cables. Order one (HE-CHASE-EXT2) or (HE-CHASE-EXT4) for each side

Heise Connect chasing controller included

**Patent pending*



HE-CHASE-WL

EXPANDABLE WHEEL RINGS - 15"-18" W/ CHASING LEDS & CONTROLLER

- 4 aluminum wheel rings, expandable from 15" to 18" diameter
- Adjusts in 0.25" diameter increments
- Cutable LED strips for inside and outside of ring
- Includes thread locking adhesive plus caps and silicone to seal LED strips
- 3M double-sided backing on LED strips
- Addressable LEDs
- All anodized aluminum and stainless-steel hardware included for long-lasting installation
- Backbone harness for left and right side included
- IP68 rating
- Option to turn lights red when braking, yellow for turn signals with the included connect controller
- NOTE: Vehicles that have a wheel base over 144 inches, will need extension cables. Order one (HE-CHASE-EXT2) or (HE-CHASE-EXT4) for each side

Heise Connect chasing controller included

**Patent pending*



**HEISE CONNECT
FREE APP**
for smartphones
and tablets



CHASING LED WHEEL LIGHT KITS



Our Chasing LED wheel light kits boast sturdy metal frames lined on two sides with IP68-rated LEDs that will give the bright glow needed to highlight custom rims. In addition, you can choose from 16 million colors and 170+ pre-made pattern effects controllable via an app for your smartphone or tablet or included RF card remote.



- HE-CHASE-W14** **14** INCH **★ IP68 ★ CERTIFIED**
- HE-CHASE-W155** **15.5** INCH
- HE-CHASE-W17** **17** INCH

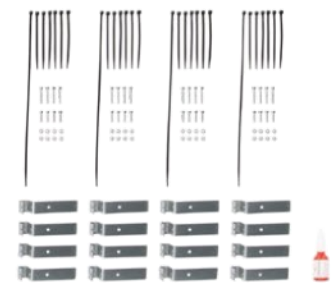

- 4 durable anodized aluminum wheel rings
- Double-sided LED strips that will vibrantly light up the vehicle's wheels
- 3 sizes available: 14", 15.5", 17"
- Mounts to OE disc brake shield
- All anodized aluminum and stainless-steel hardware included for a long-lasting installation
- Thread locking adhesive included for a worry-free installation
- Water-resistant Heise connector
- IP68 rating
- Includes RF card remote and extension cables
- Option to turn lights red when braking, yellow for turn signals with the included connect controller
- NOTE: Vehicles that have a wheel base over 144 inches, will need extension cables. Order one (HE-CHASE-EXT2) or (HE-CHASE-EXT4) for each side

Heise Connect chaching controller included



**HEISE CONNECT
FREE APP**
for smartphones
and tablets

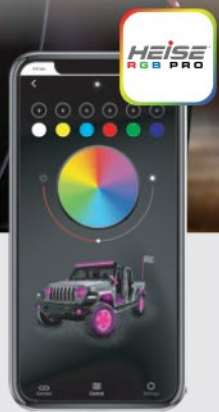



HE-CHASE-R1

WIDE-ANGLE CHASING ROCK LIGHT - SINGLE ROCK LIGHT

- (1) Chasing LED rock light
 - Addressable LEDs
 - Daisy-chainable (in/out cables)
 - Rubber curved mounting base included
 - Output Angle: 180°
 - Lens Material: Polycarbonate
 - Body Material: Aluminum Alloy
 - Hardware Material: Aluminum Alloy
 - IP67 rating
 - Cable Length: 5"
 - Extensions Included: None
 - Works with HE-CHASE-CB Heise Connect controller (sold separately)
- * Use to expand the HE-CHASE-K4 and HE-CHASE-K8 kits



Pod sold individually

HE-CHASE-K4

WIDE-ANGLE CHASING ROCK LIGHT KIT - 4 PIECE W/ CONTROLLER

- (4) Chasing LED rock lights
- Addressable LEDs
- Daisy-chainable (in/out cables)
- Rubber curved mounting base included
- Output Angle: 180°
- Lens Material: Polycarbonate
- Body Material: Aluminum Alloy
- Hardware Material: Aluminum Alloy
- IP67 rating
- Cable Length: 5"
- Extensions Included: (4) 10'

Heise Connect chasing controller included



HE-CHASE-K8

WIDE-ANGLE CHASING ROCK LIGHT KIT - 8 PIECE W/ CONTROLLER

- (8) Chasing LED rock lights
- Addressable LEDs
- Daisy-chainable (in/out cables)
- Rubber curved mounting base included
- Output Angle: 180°
- Lens Material: Polycarbonate
- Body Material: Aluminum Alloy
- Hardware Material: Aluminum Alloy
- IP67 rating
- Cable Length: 5"
- Extensions Included: (4) 10', (4) 2'

Heise Connect chasing controller included



CHASING LED ROCK LIGHT KITS

For drivers who want to show multiple colors at the same time, Heise's Chasing LED Rock Light Kit offers more than 170 pre-programmed modes for patterns with 16 million different colors. 12volt triggers are available for the turn signal and brake. The kits include the Heise Connect Controller with two wireless control options; an included remote control or using a free app for a smartphone or tablet

HE-CHASE-4KT

4 CHASING LED ROCK LIGHT KIT WITH CONNECT CHASE CONTROLLER 12W

- 4 sealed, 6 LED chasing rock lights
- Mounting hardware & cables included
- Water-resistant Heise connector
- Includes RF card remote
- App controlled via Heise Connect app
- Option to turn lights red when braking, yellow for turn signals with the included connect controller

Heise Connect chasing controller included



HE-CHASE-8KT

8 CHASING LED ROCK LIGHT KIT WITH CONNECT CHASE CONTROLLER 12W

- 8 sealed, 6 LED chasing rock lights
- Mounting hardware & cables included
- Water-resistant Heise connector
- Includes RF card remote
- App controlled via Heise Connect app
- Option to turn lights red when braking, yellow for turn signals with the included connect controller

Heise Connect chasing controller included



COMMON FEATURES

WATTAGE: (6) 0.5-WATT SMD CHASING LEDS PER ROCK LIGHT

BEAM PATTERN: 150°

HOUSING MATERIAL: DIE-CAST ALUMINUM ALLOY

COLOR: BLACK

LENS MATERIAL: POLYCARBONATE

CABLE LENGTH: 9.8' (3M)

IP RATING: IP67



CHASING UNDERGLOW LIGHTING

This underglow kit includes 6 sealed LED tubes, mounting hardware, RF card remote, and Heise Connect chasing controller. The Chasing tube layout was designed to separate the left and right sides of a vehicle. When a pattern is selected within the app, that lighting pattern will track down each side of the vehicle with the same timing. The Connect Controller provides 12volt triggers for the option to turn lights red when vehicle is braking and yellow for turn signal indication.



HE-CHASE-UNDGKT

CHASING LED UNDERGLOW LIGHTING KIT WITH CONNECT CHASE

- 6 sealed polycarbonate LED tubes: (4) 18" & (2) 48"
- Includes RF card remote, mounting hardware, and extension cables
- Water-resistant Heise connector
- App controlled via Heise Connect app
- Option to turn lights red when braking, yellow for turn signals with the included Heise Connect chasing controller

Heise Connect chasing controller included



**HEISE CONNECT
FREE APP**
for smartphones
and tablets



CHASING LED LIGHTING ACCESSORIES

HE-CHASE-Y

1 FOOT

CHASING Y ADAPTER



- Individually packaged
- Works with HE-CHASE-CB Heise Connect chasing controller
- "Y" adapter, 1 male to 2 female



HE-CHASE-2EXT

2 FEET

CHASING EXTENSION CABLE



- Individually packaged
- Works with HE-CHASE-CB Heise Connect chasing controller



HE-CHASE-4EXT

4 FEET

CHASING EXTENSION CABLE



- Individually packaged
- Works with HE-CHASE-CB Heise Connect chasing controller



CHASING LED LIGHTBARS NEW

HEISE CONNECT
FREE APP

HE-CHASE-B8

8 INCH

18 LED

★ IP68 ★
CERTIFIED



Wattage: 16.5W • Raw Lumens: 2145lm • Lux @ 10m: 47 lx
Current Consumption @ 13.8V: 1.2A
Heise Connect chasing controller included



HE-CHASE-B12

12 INCH

36 LED

★ IP68 ★
CERTIFIED



Wattage: 33.1W • Raw Lumens: 4303lm • Lux @ 10m: 73 lx
Current Consumption @ 13.8V: 2.4A
Heise Connect chasing controller included



HE-CHASE-B22

22 INCH

60 LED

★ IP68 ★
CERTIFIED



Wattage: 67.62W • Raw Lumens: 8790lm • Lux @ 10m: 92 lx
Current Consumption @ 13.8V: 4.9A
Heise Connect chasing controller included



HE-CHASE-B32

32 INCH

90 LED

★ IP68 ★
CERTIFIED



Wattage: 82.8W • Raw Lumens: 107640lm • Lux @ 10m: 142 lx
Current Consumption @ 13.8V: 6.0A
Heise Connect chasing controller included



COMMON FEATURES

INPUT VOLTAGE: 12-24V DC

COLOR TEMPERATURE: 6000K

BEAM PATTERN: 120° SPOT

HOUSING MATERIAL: ALUMINUM

COLOR: BLACK

MEMBRANE: SEALED

LENS MATERIAL: POLYCARBONATE

MOUNTING BOLT DRILL: 0.25"

ELECTRONICS: INTEGRATED EPOXY-ENCAPSULATED

HARDWARE: STAINLESS 316

OPERATING TEMPERATURE: -40°F TO +140°F

PROTECTION: REVERSE POLARITY

MOUNTING: SIDE

IP RATING: IP68A

CHASING LED LIGHTBARS & CUBES

LIGHTBAR SPECS & MEASUREMENTS

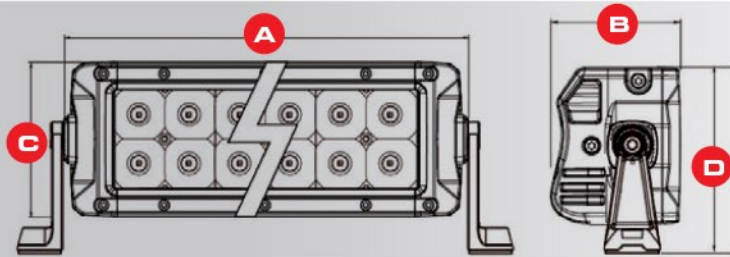

PART	A	B	C
HE-CHASE-B8	8.07"	3.15"	1.69"
HE-CHASE-B12	13.19"	3.15"	1.69"
HE-CHASE-B22	22.04"	3.15"	1.69"
HE-CHASE-B32	31.89"	3.15"	1.69"

CHASING LED CUBES NEW

HE-CHASE-CLKT **3 INCH**

32 LED **2 PACK** **★ IP67 ★ CERTIFIED**



Wattage: 22W • **Raw Lumens:** 2860lm
Lux @ 10m: 20 lx • **Beam Pattern:** 120° Spot
Current Consumption @ 13.8V: 1.6A
Heise Connect chasing controller included

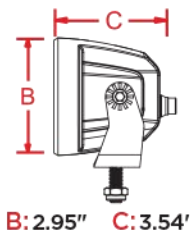

HE-CHASE-FCLKT **3 INCH**

32 LED **2 PACK** **★ IP67 ★ CERTIFIED**



Wattage: 22W • **Raw Lumens:** 2860lm
Lux @ 10m: 20 lx • **Beam Pattern:** 120° Spot
Current Consumption @ 13.8V: 1.6A
Heise Connect chasing controller included

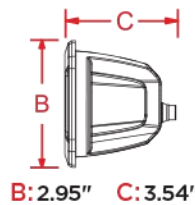

COMMON FEATURES

- INPUT VOLTAGE:** 9-36V DC
- COLOR TEMPERATURE:** 6000K
- BEAM PATTERN:** 120° SPOT
- HOUSING MATERIAL:** DIE-CAST ALUMINUM
- COLOR:** BLACK
- LENS MATERIAL:** POLYCARBONATE
- MOUNTING BRACKET:** STAINLESS STEEL
- ELECTRONICS:** INTEGRATED EPOXY-ENCAPSULATED
- HARDWARE:** ALUMINUM
- OPERATING TEMPERATURE:** -40°F TO +140°F
- PROTECTION:** REVERSE POLARITY
- IP RATING:** IP67



All chasing light products get the **HEISE CONNECT FREE APP** for smartphones and tablets



★ IP68 ★ CERTIFIED



HE-CHASE-CB

CONTROL BOX

Included with all Chasing LED lights

VEHICLE HEADLIGHT REPLACEMENT

HEISE CONNECT
FREE APP

JP-707RGBKT

CHASING HALO LED 7" HEADLIGHTS & 4" FOG LIGHTS W/ CONTROLLER

★ IP68 ★
CERTIFIED



HEADLIGHT FEATURES:

- Pair of 7" headlights
- 50 watts each
- Lumens: 4200lm (high beam), 3200lm (low beam)
- Color Temperature: 6500K
- Material: Die-cast aluminum alloy housing
- Lens: Polycarbonate
- IP68 rating
- Operating Voltage: 10-32V
- (2) H4 to H13 connectors included
- CANBUS decoders included



FOG LIGHT FEATURES:

- Pair of 4" LED fog lights
- 30 watts each
- Lumens: 3600lm
- Color Temperature: 6500K
- Material: Die-cast aluminum alloy housing
- Lens: Polycarbonate
- IP Rating: IP68
- Chase lights are for off-road use only, and not for use on public roads
- Chasing products are not compatible with other RGB or RGBW products



Heise Connect chasing controller included

JP-708RGBKT

CHASING RGB 7" PROJECTOR LIGHTS & 4" FOG LIGHTS W/ CONTROLLER

★ IP68 ★
CERTIFIED



HEADLIGHT FEATURES:

- Pair of 7" projector headlights
- 55 watts each
- Lumens: 8000lm (High beam), 6000lm (Low beam)
- Color Temperature: 6500K
- Material: Die-cast aluminum alloy housing
- Lens: Polycarbonate
- IP68 rating
- Operating Voltage: 10-32V
- (2) H4 to H13 connectors included
- CANBUS decoders included



FOG LIGHT FEATURES:

- Pair of 4" halo LED fog lights
- 30 watts each
- Lumens: 3600lm
- Color Temperature: 6500K
- Material: Die-cast aluminum alloy housing
- Lens: Polycarbonate
- IP Rating: IP68
- Chase lights are for off-road use only, and not for use on public roads
- Chasing products are not compatible with other RGB or RGBW products



Heise Connect chasing controller included

HEISE CONNECT
FREE APP

VEHICLE HEADLIGHT REPLACEMENT

1997-UP* JEEP WRANGLER
2020-UP* JEEP GLADIATOR JT

JP-709RGB

**7" PREMIUM CHASING LED
HEADLIGHTS - SEALED LIGHTS**

**★ IP68 ★
CERTIFIED**



- Wattage: 49W (per light)
- Lumens: 3000lm (high beam), 1900lm (low beam)
- Color Temperature: 6500K
- Material: Die-cast aluminum alloy housing
- Lens: Polycarbonate
- IP67K rating
- Operating Voltage: 12V
- Operating Temperature: -40°F to 140°F
- H4 to H13 connectors included
- JP-JLB7 adapter bracket is required for the JL and JT

Heise Connect chasing controller included



2018-UP* JEEP WRANGLER JL
2020-UP* JEEP GLADIATOR JT

JP-901RGBKT

**9" PREMIUM CHASING LED
HEADLIGHTS - HEADLIGHT ASSEMBLY**

**★ IP68 ★
CERTIFIED**



- Wattage: 64W (per light)
- Lumens: 4300lm (high beam), 2100lm (low beam)
- Color Temperature: 6500K
- Material: Reinforced polypropylene housing
- Lens: Polycarbonate
- IP67K rating
- Operating Voltage: 12V
- Operating Temperature: -40°F to 140°F
- Direct bolt-on replacement
- Plugs into OE harness
- CANBUS decoders included

Heise Connect chasing controller included



Upgrade Your Lighting. Anytime. Anywhere.



HE-RGB-CB



HEISE CONNECT CONTROLLER

- RGB LED controller
- 24 color-changing patterns
- Turn signal function (both left and right)
- Brake function
- DIY pattern function
- Music sync function
- App controlled (Heise Connect app) or via the included RF card remote
- Max load 10A
- Water-resistant Heise connector
- Works with RGB LED products only
- Can be grouped in the app with any Heise Connect controller (RGB, RGBW, and Chasing)

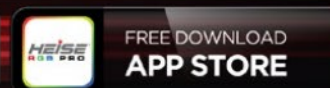
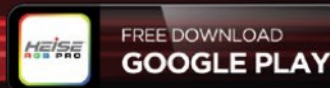

Download it FREE

7 INCH **6 LED** **★ IP67 ★ CERTIFIED**  RGB LEDs

JP-704RGB **RGB BLACK FRONT FACE HEADLIGHTS**

Wattage: 150W • **Current Consumption @ 13.8V:** Low beam - 3.74A

Current Consumption @ 13.8V: High beam - 6.8A

Raw Lumens: Low beam - 2200lm • **Raw Lumens:** High beam - 4000lm

- Number of RGB LEDs (per light): 15 LEDs, 0.6W/LED
- Number of Halo LEDs (per light): white - 16 LEDs, 1.5W/LED amber - 16 LEDs, 0.2W/LED
- Works with HE-RGB-CB RGB control box (sold separately)

Sold as a pair



4 INCH **15 LED** **★ IP67 ★ CERTIFIED**  RGB LEDs

JP-704RGBFL **RGB BLACK FRONT FACE FOG LIGHTS**

Wattage: 60W • **Current Consumption @ 13.8V:** 1.6A

Raw Lumens: 1600lm

- Standard 9145 connector
- LED color temp 6500K
- Number of RGB LEDs (per light): 6 LEDs, 0.2W/LED
- Number of Halo LEDs (per light): 12 LEDs, 0.2W/LED
- Works with HE-RGB-CB RGB control box (sold separately)

Sold as a pair



COMMON FEATURES

HOUSING: DIE-CAST ALUMINUM

LED COLOR: 6500K

LENS: POLYCARBONATE

ADDITIONAL ACCESSORIES

FOR HEISE RGB AND 704RGB HEADLIGHTS/FOG LIGHTS

HE-RGB-CB **RGB CONTROL BOX** **SOLD SEPARATELY**

- Addressable LED controller
- 170+ color-changing patterns
- Turn signal function (both left and right)
- Brake function
- DIY pattern function
- Music sync function

- App controlled (Heise Connect app) or via the included RF card remote
- Max load 10A
- Can be grouped in the app with any Heise Connect controller (RGB, RGBW, and Chasing)



HEISE CONNECT
FREE APP
for smartphones
and tablets



RGB ACCENT LIGHTS

7 INCH

6 LED

★ IP67 ★
CERTIFIED



RGB LEDs

HE-PBHL702RGB

BLACK FRONT FACE W/ FULL RGB HALO

Wattage: (6) 10-watt LEDs per housing
2000lm low beam, draws 1.9A @ 13.8V
3000lm high beam, draws 2.7A @ 13.8V

- Standard H4 connector
- Requires RGB-CB3 control box required for operation (sold separately)

Sold as a pair



4 INCH

3 LED

★ IP67 ★
CERTIFIED



RGB LEDs

HE-JWBFL02RGB

BLACK FRONT FACE FOG LIGHTS W/FULL RGB HALO

Wattage: (3) 10-watt LEDs per housing
Raw Lumens: 1200lm (set)
Current Consumption @ 13.8V: 1.4A (halo off) 1.6A (halo on)

- Standard 9145 connector
- Connect to running lights
- Requires RGB-CB3 control box required for operation (sold separately)

Sold as a pair



COMMON FEATURES

HOUSING: DIE-CAST ALUMINUM ALLOY

LED COLOR: 6500K

LENS: POLYCARBONATE

ADDITIONAL ACCESSORIES

FOR HEISE 702RGB HEADLIGHTS AND FL02RGB FOG LIGHTS

RGB-CB3

RGB CONTROL BOX

SOLD SEPARATELY

- App controlled on smart phones and tablets
- 16 million color options
- Group multiple devices
- Camera color capture
- Sync lighting to your music
- Rainbow, water and fire patterns
- Fade, blink and pulsating transitions
- 4 programmable triggers
- Handles up to 10 amps of lights



**HEISE CONNECT
FREE APP**

RGB ACCENT LIGHTS

RGB1-4KT

RGB

4 POD ROCK LIGHT SET

**★ IP68 ★
CERTIFIED**



- (3) 3-watt LEDs per pod
- Raw Lumens: 720lm
- Stainless 316 hardware included
- Current consumption @ 13.8V 0.2A
- Polycarbonate lens
- Works with HE-RGB-CB and Heise Connect app (sold separately)
- 10' of cable on each pod



HE-TL1RGB

1.5x3 INCH

SINGLE RGB ROCK LIGHT

**★ IP68 ★
CERTIFIED**



- (3) 3-watt LEDs
- Raw Lumens: 720lm
- Stainless 316 hardware included
- Black die-cast aluminum housing
- Polycarbonate lens
- Works with HE-RGB-CB and Heise Connect app (sold separately)
- 10' of cable on each pod

Pod sold individually



HE-ML1RGB

1.5x3 INCH

SINGLE RGB ROCK LIGHT

**★ IP68 ★
CERTIFIED**



- (3) 3-watt LEDs
- Raw Lumens: 720lm
- Stainless 316 hardware included
- White die-cast aluminum housing
- Polycarbonate lens
- Works with HE-RGB-CB and Heise Connect app (sold separately)
- 10' of cable on each pod

Pod sold individually



**HEISE CONNECT
FREE APP**
for smartphones
and tablets

ADDITIONAL ACCESSORIES

ACCENT LIGHTING COVERS



HE-TL1DIV



HE-ML1DIV

The light cover is for use with HE-TL1(xxx) and HE-ML1(xxx) rock lights.



HE-RGB-R1

WIDE-ANGLE RGB ROCK LIGHT - SINGLE ROCK LIGHT



RGB LEDs

- (1) RGB LED rock light
 - Daisy-chainable (in/out cables)
 - Rubber curved mounting base included
 - Output Angle: 180°
 - Lens Material: Polycarbonate
 - Body Material: Aluminum Alloy
 - Hardware Material: Aluminum Alloy
 - IP67 rating
 - Cable Length: 5"
 - Extensions Included: None
 - Works with HE-RGB-CB controller (sold separately)
- * Use to expand the HE-RGB-K4 and HE-RGB-K8 kits



Pod sold individually

HE-RGB-K4

WIDE-ANGLE RGB ROCK LIGHT KIT - 4 PIECE W/ CONTROLLER



RGB LEDs

- (4) RGB LED rock lights
 - Daisy-chainable (in/out cables)
 - Rubber curved mounting base included
 - Output Angle: 180°
 - Lens Material: Polycarbonate
 - Body Material: Aluminum Alloy
 - Hardware Material: Aluminum Alloy
 - IP67 rating
 - Cable Length: 5"
 - Extensions Included: (4) 10'
- Heise Connect RGB controller included*



HE-RGB-K8

WIDE-ANGLE RGB ROCK LIGHT KIT - 8 PIECE W/ CONTROLLER



RGB LEDs

- (8) RGB LED rock lights
 - Daisy-chainable (in/out cables)
 - Rubber curved mounting base included
 - Output Angle: 180°
 - Lens Material: Polycarbonate
 - Body Material: Aluminum Alloy
 - Hardware Material: Aluminum Alloy
 - IP67 rating
 - Cable Length: 5"
 - Extensions Included: (4) 10', (4) 2'
- Heise Connect RGB controller included*



4 UNDERGLOW LED TUBES

Heise launched new LED light kits to dress up your ride and you will not go unnoticed! This underglow kit is designed to handle rain, snow, and dirt. Rated IP67, these lights are designed for all-terrain on powersports vehicles, boats, cars, and more! Installation videos can also be found online at HeiseLED.com

RGB1-UNDGLED

UNIVERSAL

4 UNDERGLOW LED TUBES



RGB LEDs

- Tube lengths: (2) 48" and (2) 36"
- Dual connection to controller maximum current and even illumination
- Mounting hardware and extension cables included
- Works with HE-RGB-CB and Heise Connect app (sold separately)



ADDITIONAL ACCESSORIES

FOR HEISE RGB AND 704RGB HEADLIGHTS/FOG LIGHTS

HE-RGB-CB

RGB CONTROL BOX

SOLD SEPARATELY

- Addressable LED controller
- 170+ color-changing patterns
- Turn signal function (both left and right)
- Brake function
- DIY pattern function
- Music sync function
- App controlled (Heise Connect app) or via the included RF card remote
- Max load 10A
- Can be grouped in the app with any Heise Connect controller (RGB, RGBW, and Chasing)



**HEISE CONNECT
FREE APP**
for smartphones
and tablets



EXPANDABLE RGB LED WHEEL RINGS

HE-RGB-WS

EXPANDABLE WHEEL RINGS - 11"-14" W/ RGB LEDS & CONTROLLER



RGB LEDS

- 4 aluminum wheel rings, expandable from 11" to 14" diameter
- Adjusts in 0.25" diameter increments
- Cutable LED strips for inside and outside of ring
- Includes thread locking adhesive plus caps and silicone to seal LED strips
- 3M double-sided backing on LED strips
- All anodized aluminum and stainless-steel hardware included for long-lasting installation
- Backbone harness for left and right side included
- IP68 rating
- Option to turn lights red when braking, yellow for turn signals with the included connect controller
- NOTE: Vehicles that have a wheel base over 144 inches, will need extension cables. Order one (HE-CHASE-EXT2) or (HE-CHASE-EXT4) for each side

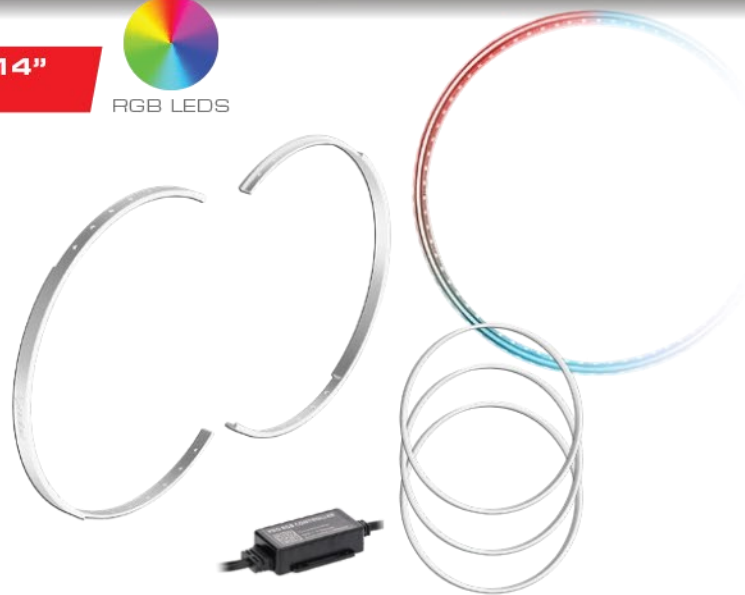

Heise Connect RGB controller included

**Patent pending*

HE-RGB-WL

EXPANDABLE WHEEL RINGS - 15"-18" W/ RGB LEDS & CONTROLLER



RGB LEDS

- 4 aluminum wheel rings, expandable from 15" to 18" diameter
- Adjusts in 0.25" diameter increments
- Cutable LED strips for inside and outside of ring
- Includes thread locking adhesive plus caps and silicone to seal LED strips
- 3M double-sided backing on LED strips
- All anodized aluminum and stainless-steel hardware included for long-lasting installation
- Backbone harness for left and right side included
- IP68 rating
- Option to turn lights red when braking, yellow for turn signals with the included connect controller
- NOTE: Vehicles that have a wheel base over 144 inches, will need extension cables. Order one (HE-CHASE-EXT2) or (HE-CHASE-EXT4) for each side



Heise Connect RGB controller included

**Patent pending*



**HEISE CONNECT
FREE APP**
for smartphones
and tablets

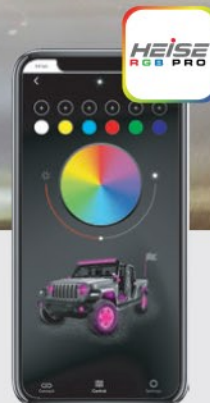

RGB LED WHEEL LIGHT KITS

Our RGB wheel light kits boast sturdy metal frames that are lined on two sides with IP68 rated LEDs that will give the bright glow needed to highlight custom rims. Add in Metra's universal RGB or RGBW underglow LED lighting kits and you will not go unnoticed! Rated IP68, these lights are designed for the elements! An Installation video can be found online at HeiseLED.com

UNIVERSAL **RGB LED WHEEL LIGHT KITS** ★ IP67 ★ CERTIFIED RGB LEDs



- HE-RGB1-W14** 14 INCH
- HE-RGB1-W155** 15.5 INCH
- HE-RGB1-W17** 17 INCH

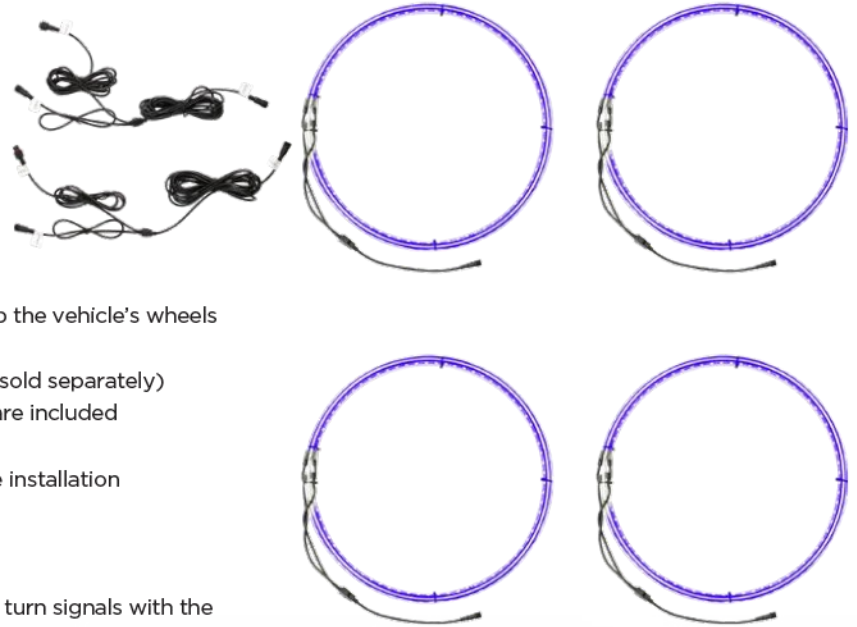

- 4 durable anodized aluminum wheel rings
- RGB + true white LEDs
- Double-sided LED strips that will vibrantly light up the vehicle's wheels
- Mounts to OE disc brake shield
- Works with HE-RGB-CB and Heise Connect app (sold separately)
- All anodized aluminum and stainless-steel hardware included for a long-lasting installation
- Thread locking adhesive included for a worry-free installation
- IP68 rating
- Water-resistant Heise connectors
- 1-year limited warranty
- Option to turn lights red when braking, yellow for turn signals with the included connect controller
- NOTE: Vehicles that have a wheel base over 144 inches, will need extension cables. Order one (HE-CHASE-EXT2) or (HE-CHASE-EXT4) for each side

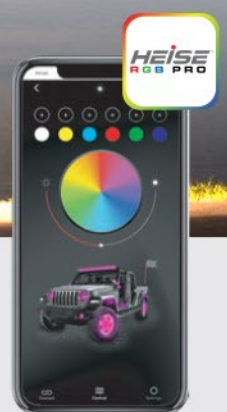
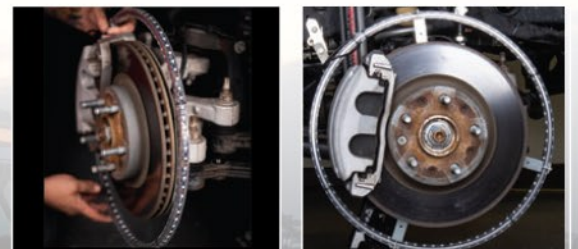

**HEISE CONNECT
FREE APP**
for smartphones
and tablets

INFINITE CUBE LED LIGHTS

HE-FMICL2

5 INCH

8 LED

**★ IP67 ★
CERTIFIED**



RGB LEDS

Wattage: 11.5W • **Raw Lumens:** 1080lm • **Lux @ 10m:** 170
Current Consumption @ 13.8V: 0.83A

• HE-RGB-CB controller required (sold separately)

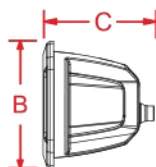

B: 4.8" **C:** 3.6"



HE-ICL2

3 INCH

4 LED

**★ IP67 ★
CERTIFIED**



RGB LEDS

HE-ICL2PK

3 INCH

4 LED

2 PACK

**★ IP67 ★
CERTIFIED**

Wattage: 13W • **Raw Lumens:** 1080lm • **Lux @ 10m:** 411
Current Consumption @ 13.8V: 0.9A

• HE-RGB-CB controller required (sold separately)
Heise HE-DLWH1 dual light wiring harness included

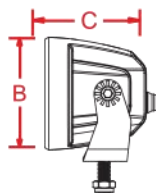

B: 3.43" **C:** 3.22"



**HEISE CONNECT
FREE APP**
for smartphones and tablets



**★ IP68 ★
CERTIFIED**



HE-RGB-CB

CONTROL BOX

Required for RGB functionality
on all Infinite Series lights.
(sold separately)

COMMON FEATURES

INPUT VOLTAGE: 10-30V DC

COLOR TEMPERATURE: 6000K

BEAM PATTERN: 8° SPOT

HOUSING MATERIAL: DIE-CAST ALUMINUM

COLOR: BLACK

LENS MATERIAL: POLYCARBONATE

MOUNTING BRACKET: STAINLESS STEEL

ELECTRONICS: INTEGRATED-EPOXY ENCAPSULATED

HARDWARE: STAINLESS 316

OPERATING TEMPERATURE: -40°F TO +140°F

PROTECTION: REVERSE POLARITY

IP RATING: IP67



Spare Tire Light

Fits 2022 Ford Bronco

Heise brings you another first, this time for the 2022 Ford Bronco. The all new LED Spare Tire Light mounts cleanly behind the spare tire and connects with an easy two wire hook up. The light will not only add style to the Bronco, but will improve awareness for others while braking. Made from black ABS plastic and a smoked poly-carbonate lens, the spare tire light is almost unnoticeable when off.



HE-FDSTL

- ✓ (85) 1-watt LEDs
- ✓ Brake light
- ✓ 2 wire hook



HEISELED.COM | 386-257-2956



WARNING:
Cancer and Reproductive Harm
www.P65Warnings.ca.gov

Copyright ©2022 Metra Electronics Corporation

INFINITE SERIES LED LIGHTBARS

HE-INFIN8 **8** INCH **12** LED **★ IP67 ★ CERTIFIED**  RGB LEDS

Wattage: 18W • **Raw Lumens:** 2280lm • **Lux @ 10m:** 235
Current Consumption @ 13.8V: 1.3A

- HE-RGB-CB controller required (sold separately)



HE-INFIN22 **22** INCH **40** LED **★ IP67 ★ CERTIFIED**  RGB LEDS

Wattage: 60W • **Raw Lumens:** 7600lm • **Lux @ 10m:** 1150
Current Consumption @ 13.8V: 4.34A

- HE-RGB-CB controller required (sold separately)



HE-INFIN30 **30** INCH **56** LED **★ IP67 ★ CERTIFIED**  RGB LEDS

Wattage: 84W • **Raw Lumens:** 10640lm • **Lux @ 10m:** 1426
Current Consumption @ 13.8V: 6.1A

- HE-RGB-CB controller required (sold separately)



HE-INFIN40 **40** INCH **76** LED **★ IP67 ★ CERTIFIED**  RGB LEDS

Wattage: 114W • **Raw Lumens:** 14440lm • **Lux @ 10m:** 1780
Current Consumption @ 13.8V: 9.5A

- HE-RGB-CB controller required (sold separately)



INFINITE SERIES LED LIGHTBARS



- INPUT VOLTAGE:** 10-30V DC
- COLOR TEMPERATURE:** 6000K
- BEAM PATTERN:** 8° SPOT
- HOUSING MATERIAL:** DIE-CAST ALUMINUM
- COLOR:** BLACK
- MEMBRANE:** MILITARY BREATHER
- LENS MATERIAL:** POLYCARBONATE
- MOUNTING BOLT DRILL:** 0.25"
- ELECTRONICS:** INTEGRATED EPOXY-ENCAPSULATED
- HARDWARE:** STAINLESS 316
- OPERATING TEMPERATURE:** -40°F TO +140°F
- PROTECTION:** REVERSE POLARITY
- IP RATING:** IP67

**HEISE CONNECT
FREE APP**

for smartphones
and tablets



SPECS & MEASUREMENTS

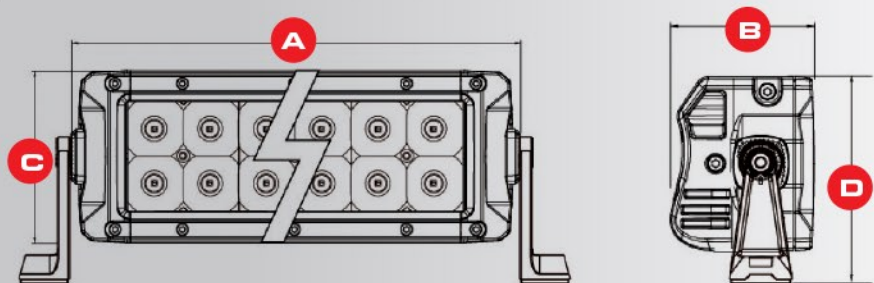

★ IP68 ★
CERTIFIED

HE-RGB-CB

CONTROL BOX

Required for RGB functionality
on all Infinite Series lights.
(sold separately)

PART	A	B	C	D
HE-INFIN8	8.11"	2.56"	3.09"	4.84"
HE-INFIN22	22.17"	2.56"	3.09"	4.84"
HE-INFIN30	30.20"	2.56"	3.09"	4.84"
HE-INFIN40	40.24"	2.56"	3.09"	4.84"
HE-INFIN50	50.12"	2.56"	3.09"	4.84"

MOTORCYCLE RGB LIGHT KIT

12-STRIP RGB PLUG-N-PLAY KIT WITH CONTROLLER

BC-RGB-K1

1996-UP*

FITS HARLEY-DAVIDSON FLH AND FLT WITH TOUR-PAK®

**★ IP67 ★
CERTIFIED**



- Kit is completely plug-n-play with OE style connections
- Water-tight connectors
- 5050 LED strips with black base
- 3M adhesive backing
- RGB colors are app controlled
- Trigger controls for brake and turn signals pre-wired

KIT INCLUDES

- Plug-n-play rear lighting T-harnesses
- 1996-2013 8-pin OE plug
- 2010-2013 6-pin OE plug
- 2014-UP* 6-pin OE plug
- Independent On/Off switch that can turn your lights on with ignition off
- RGB controller
- Alcohol prep pads, adhesive promoter and zip ties

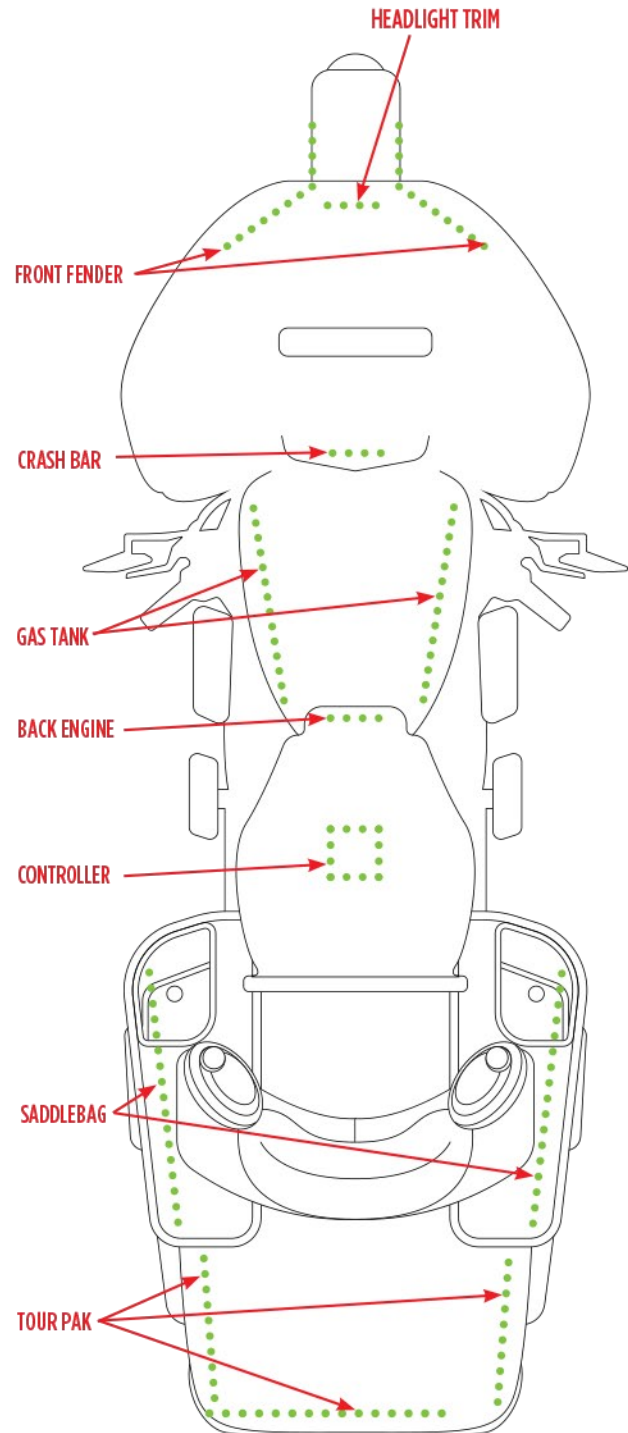

Download it FREE

RGB LED STRIP LIGHT KITS

H-RGB5MRK2

KIT RGB

5 METER



- 5 meters (16.4 feet) RGB light strip
- 5050 SMD LEDs at 60 LEDs per meter
- Includes (1) 24-key IR remote, RGB controller, and 3-amp power supply
- IP65 water-resistant covering



H-RGB5MRK1

KIT RGB

5 METER



- 5 meters (16.4 feet) RGB light strip
- 3528 SMD LEDs at 60 LEDs per meter
- Includes (1) 24-key IR remote, RGB controller, and 3-amp power supply
- IP65 water-resistant covering



RGB LED STRIP LIGHTS AND ACCESSORIES

HE-RFRGBC-1

RF

- 16 color RGB control unit
- Controlled via an included 24-button RF remote control
- Cord for LEDs to plug into is 15"
- On/Off buttons with built-in 8-way dimmer
- "Flash", "Strobe", "Fade" and "Smooth" buttons
- Draws 1.2 amps



RETAIL PKG

WHITE BOX PKG

H-RGBC-1

HE-RGBC-1

IR

- 16 color RGB control unit
- Controlled via an included 24-button IR remote control
- Cord for LEDs to plug into is 15"
- On/Off buttons with built-in 8-way dimmer
- "Flash", "Strobe", "Fade" and "Smooth" buttons
- Draws 1.2 amps



IR LED is attached to control box by a 17" long cord

RETAIL PKG

ANTI-STATIC PKG

H-5MRGB-1

WHITE BASE

HE-5MRGB-1

WHITE BASE

HE-5MBRGB-1

BLACK BASE



RGB LEDs

5 METER

16 COLOR RGB

- 16 different selectable colors
- 5 meter flexible LED roll
- 5050 RGB LEDs
- 60 LEDs per meter, 300 total
- LED strip is 10mm wide and 2.5mm thick
- IP65 rated water-resistant covering
- 3M adhesive tape backing
- 12V DC input
- Able to be cut every 3rd LED
- H-RGBC-1 control unit is required (sold separately)

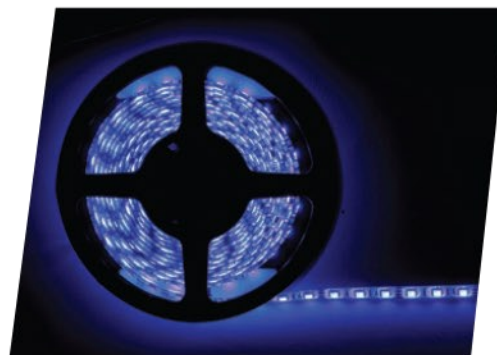

HE-5MRGB-3

5 METER

132 FUNCTION RGB



RGB LEDs

- 132 different functions that will get attention
- 5 meter flexible LED roll
- 5050 RGB LEDs
- LED strip is 10mm wide and 4mm thick



RGB LED STRIP LIGHT ACCESSORIES

HE-RGBAMP-1 IN-LINE AMPLIFIER

- In-line amplifier for H-5MRGB-1 LED strip lights
- Add after each 5 meter roll
- Functions of the RGB control box will be passed through the HE-RGBAMP-1



HE-ECRGB4PIN-1

SOLDERLESS CONNECTOR

- Solderless connection for H-5MRGB-1 to 4-pin header allows use of H-RGBAMP-1 with cut sections of H-5MRGB-1



HE-RGBWIRE50-1 50 FEET

RGB 4-CONNECTOR WIRE

- 4-conductor RGB wire for use with H-5MRGB-1
- Length: 50' (15.24 meters)



HE-RGBWIRE100-1 100 FEET

RGB 4 CONNECTOR WIRE

- 4-conductor RGB wire for use with H-5MRGB-1
- Length: 100' (30.48 meters)



RGB-250SPL RGB RGB 4-CONDUCTOR POWER WIRE

SPECS

- Length: 250'
- Gauge: 22AWG
- Wire Colors: R/G/B/BL
- Water-resistant black over-mold
- Works with Metra RGB lights



RGB COMPLETE LIGHT KITS

2018-UP* JEEP WRANGLER JL
2020-UP* JEEP GLADIATOR JT

JP-RGBKT-1 COMPLETE LIGHTING KIT

★ IP67 ★
CERTIFIED



RGB LEDS

- Choose from 16 million different color options using the Heise Connect app with pre-built lighting transitions, flash patterns, and more
- Includes:
 - (2) 48" and (2) 36" LED underglow tubes
 - (1) 10" and (1) 18" LED grille tubes
 - 4 LED wheel-well rock lights
 - (4) 10" LED interior foot-well tubes
 - JP-APJLJT accessory quick connect
- Dual interior and exterior connections to the controller for maximum current and even illumination
- Mounting hardware and extension cables included
- In-depth installation guide included
- Full kit current draw: 4.5A @13.8V
- Rated IP67
- Expandable with Heise Infinite Series RGB lighting

Heise Connect RGB controller included



HEISE CONNECT
FREE APP
for smartphones
and tablets



Complete Interior + Exterior RGB Lighting Kit Designed to fit Jeep® Gladiator and Wrangler JL Models

Wheel Well Illumination

Expandable Options with Heise (sold separately)

Backlit Grille

Rear Underglow

Front & Rear Footwell Illumination

Side Underglow

Front Underglow

RGB COMPLETE LIGHT KITS

HE-8TLRGBK

8 RGB PODS

3 LED

★ IP68 ★
CERTIFIED



RGB LEDS

- (3) 3-watt LEDs per pod
- Raw Lumens: 720lm
- Stainless 316 hardware included
- Current Consumption @ 13.8V: 0.2A
- Polycarbonate
- 10' of cable on each pod
- RGB controller included



The HE-TL1RGB RGB accent lights and the HE-CBRGB control box will give accent lighting where you want it.

HE-8MLRGBK

8 RGB PODS

3 LED

★ IP68 ★
CERTIFIED



RGB LEDS

- (3) 3-watt LEDs per pod
- Raw lumens: 720lm
- Stainless 316 hardware included
- Current Consumption @ 13.8V: 0.2A
- Polycarbonate
- 10' of cable on each pod
- RGB controller included



The HE-8MLRGBK is a complete kit to light up your boat. These accent lights and the HE-CBRGB control box will give accent lighting where you want it.

HE-4TLRGBK

4 RGB PODS

3 LED

★ IP68 ★
CERTIFIED



RGB LEDS

- (3) 3-watt LEDs per pod
- Raw Lumens: 720lm
- Stainless 316 hardware included
- Current Consumption @ 13.8V: 0.2A
- Polycarbonate
- 10' of cable on each pod
- RGB controller included



Designed as a starter kit, this allows you to get the RGB lights in your vehicle without breaking the bank. This kit also allows for the addition of four more HE-TL1RGB lights to your existing Heise RGB rock light set up.

HE-CBRGB

8 OUTPUT

REPLACEMENT CONTROL BOX

★ IP68 ★
CERTIFIED

Control box for RGB accent lights. Water-resistant control box for HE-TL1RGB and HE-ML1RGB. Control box can be mounted in the engine bay.



ADAPTERS AND CABLES

RGB-Y1 6 INCH "Y" ADAPTER

- 6" RGB "Y" adapter
- 1 male - 2 female
- 4-pin connector works with HE-RGB-CB controller



RGB-PT1 10 INCH PIGTAIL ADAPTER

- 10"
- 4-pin RGB hardwire pigtail



HE-EXTRGB 10 FOOT 4-PIN EXTENSION

- 10'
- 4-pin extension cable
- Works with HE-RGB-CB controller



AT YOUR FINGERTIPS



Follow Us!

- **FEATURED INSTALLS**
- **Q & A**



- **NEW PRODUCTS**
- **INSTRUCTION VIDEOS**



www.instagram.com
/HeiseLED

SHARE YOUR PROJECT PHOTOS WITH US FOR A CHANCE TO BE FEATURED ON OUR SOCIAL MEDIA. TAG @HEISELED AND @METRAELELECTRONICS IN YOUR POSTS!

Upgrade Your Lighting. Anytime. Anywhere.



HE-RGBW-CB

HEISE CONNECT CONTROLLER

- RGBW LED controller
- 24 color-changing patterns
- Turn signal function (both left and right)
- Brake function
- DIY pattern function
- Music sync function
- App controlled (Heise Connect app) or via the included RF card remote
- Max load 10A
- Water-resistant Heise connector
- Works with RGBW LED products only
- Can be grouped in the app with any Heise Connect controller (RGB, RGBW, and Chasing)

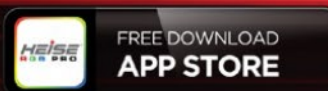

Download it **FREE**



RGBW LED ACCENT LIGHTS

RGBW-CB1

RGBW CONTROL BOX

★ IP65 ★
CERTIFIED

- App controlled on smartphones and tablets
- 16 million color options
- Group multiple devices
- Camera color capture
- Sync lighting to your music
- Rainbow, water, and fire patterns
- Fade, blink, and pulsating transitions
- 4 programmable triggers
- Handles up to 10 amps of lights



HE-RGBW-CB

HEISE CONNECT CONTROLLER - RGBW LED

HEISE CONNECT
FREE APP

- RGBW LED controller
- 24 color-changing patterns
- Turn signal function (both left and right)
- Brake function
- DIY pattern function
- Music sync function
- App controlled (Heise Connect app) or via the included RF card remote
- Max load 10A
- Water-resistant Heise connector
- Works with RGBW LED products only
- Can be grouped in the app with any Heise Connect controller (RGB, RGBW, and Chasing)



RGBW1-4KT

4 POD RGBW ROCK LIGHT KIT

HEISE CONNECT
FREE APP

★ IP68 ★
CERTIFIED

- RGB LED + True White LED
- (24) 3030 LEDs per pod
- 24 watts per pod
- Black die-cast aluminum housing
- Polycarbonate lens
- Works with HE-RGBW-CB and Heise Connect app (sold separately)



RGBW1-S1

SINGLE RGBW ROCK LIGHT

HEISE CONNECT
FREE APP

★ IP68 ★
CERTIFIED

- RGB LED + True White LED
- (24) 3030 LEDs per pod
- 24 watts per pod
- Black die-cast aluminum housing
- Polycarbonate lens
- Works with HE-RGBW-CB and Heise Connect app (sold separately)



Rock light sold individually

HE-RGBW-R1

WIDE-ANGLE RGBW ROCK LIGHT - SINGLE ROCK LIGHT



- Single RGBW LED rock light
 - Daisy-chainable (In/Out cables)
 - Rubber curved mounting base included
 - Output Angle: 180°
 - Lens Material: Polycarbonate
 - Body Material: Aluminum Alloy
 - Hardware Material: Aluminum Alloy
 - IP67 rating
 - Cable Length: 5"
 - Extensions Included: None
 - Works with HE-RGBW-CB controller (sold separately)
- *Use to expand the HE-RGBW-K4 and HE-RGBW-K8 kits



HE-RGBW-K4

WIDE-ANGLE RGBW ROCK LIGHT KIT - 4 PIECE W/ CONTROLLER



- 4 RGBW LED rock lights
 - Daisy-chainable (In/Out cables)
 - Rubber curved mounting base included
 - Output Angle: 180°
 - Lens Material: Polycarbonate
 - Body Material: Aluminum Alloy
 - Hardware Material: Aluminum Alloy
 - IP67 rating
 - Cable Length: 5"
 - Extensions Included: (4) 10'
- Heise Connect RGBW controller included*



HE-RGBW-K8

WIDE-ANGLE RGBW ROCK LIGHT KIT - 8 PIECE W/ CONTROLLER



- 8 RGBW LED rock lights
 - Daisy-chainable (In/Out cables)
 - Rubber curved mounting base included
 - Output Angle: 180°
 - Lens Material: Polycarbonate
 - Body Material: Aluminum Alloy
 - Hardware Material: Aluminum Alloy
 - IP67 rating
 - Cable Length: 5"
 - Extensions Included: (4) 10', (4) 2'
- Heise Connect RGBW controller included*



RGBW LED ACCENT LIGHT ACCESSORIES

RGBW-Y1 "Y" ADAPTER

- 6" RGBW "Y" adapter
- 1 male - 2 female
- 5-pin connector works with HE-RGBW-CB controller (sold separately)



RGBW-PT1 PIGTAIL ADAPTER

- 5-pin RGBW hardwire pigtail



RGBW1-EXT 5-PIN EXTENSION **★ IP68 ★ CERTIFIED**

- 10' 5-pin extension cable
- Works with HE-RGBW-CB controller (sold separately)
- IP68 rating



RGBW-250SPL RGBW BULK WIRE

- Length: 250'
- Gauge: 22GA
- Wire Colors: R/G/B/W/BL
- Water-resistant black over mold
- Works with Metra RGBW lights



RGBW LED ACCENT LIGHTS

Heise launched new LED light kits to dress up your ride and you will not go unnoticed! This underglow kit is designed to handle rain, snow, and dirt. Rated IP67, these lights are designed for all-terrain on powersports vehicles, boats, cars, and more! Installation videos can also be found online at HeiseLED.com

RGBW1-UNDGLED

UNIVERSAL

4 UNDERGLOW LED TUBES



RGB LEDs



TRUE WHITE LEDs

- Tube lengths: (2) 48" and (2) 36"
- Dual connection to controller maximum current and even illumination
- Mounting hardware and extension cables included
- Works with HE-RGBW-CB and Heise Connect app (sold separately)



ADDITIONAL ACCESSORIES

FOR HEISE RGBW

HE-RGBW-CB RGBW CONTROL BOX

- Addressable LED controller
- 170+ color-changing patterns
- Turn signal function (both left and right)
- Brake function
- DIY pattern function
- Music sync function
- App controlled (Heise Connect app) or via the included RF card remote
- Max load 10A
- Can be grouped in the app with any Heise Connect controller (RGB, RGBW, and Chasing)



**HEISE CONNECT
FREE APP**
for smartphones
and tablets



EXPANDABLE RGBW LED WHEEL RINGS

HE-RGBW-WS

EXPANDABLE WHEEL RINGS - 11"-14" W/ RGBW LEDS & CONTROLLER

- 4 aluminum wheel rings, expandable from 11" to 14" diameter
- Adjusts in 0.25" diameter increments
- Cutable LED strips for inside and outside of ring
- Includes thread locking adhesive plus caps and silicone to seal LED strips
- 3M double-sided backing on LED strips
- All anodized aluminum and stainless-steel hardware included for long-lasting installation
- Backbone harness for left and right side included
- IP68 rating
- Option to turn lights red when braking, yellow for turn signals with the included connect controller
- NOTE: Vehicles that have a wheel base over 144 inches, will need extension cables. Order one (HE-CHASE-EXT2) or (HE-CHASE-EXT4) for each side

Heise Connect RGBW controller included

**Patent pending*

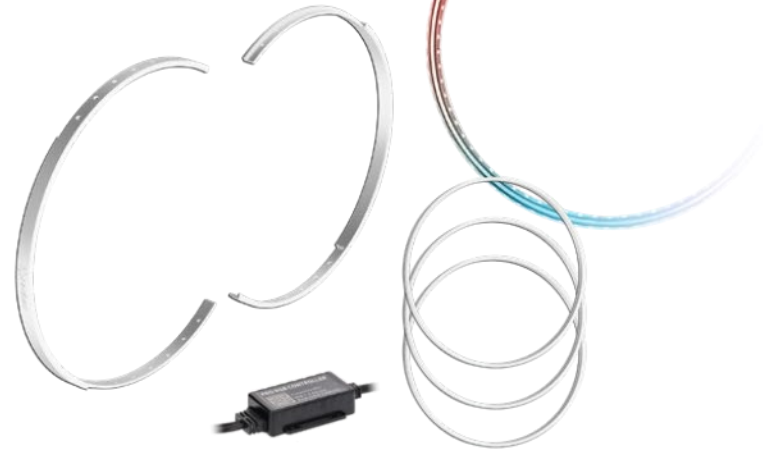

HE-RGBW-WL

EXPANDABLE WHEEL RINGS - 15"-18" W/ RGBW LEDS & CONTROLLER

- 4 aluminum wheel rings, expandable from 15" to 18" diameter
- Adjusts in 0.25" diameter increments
- Cutable LED strips for inside and outside of ring
- Includes thread locking adhesive plus caps and silicone to seal LED strips
- 3M double-sided backing on LED strips
- All anodized aluminum and stainless-steel hardware included for long-lasting installation
- Backbone harness for left and right side included
- IP68 rating
- Option to turn lights red when braking, yellow for turn signals with the included connect controller
- NOTE: Vehicles that have a wheel base over 144 inches, will need extension cables. Order one (HE-CHASE-EXT2) or (HE-CHASE-EXT4) for each side

Heise Connect RGBW controller included

**Patent pending*

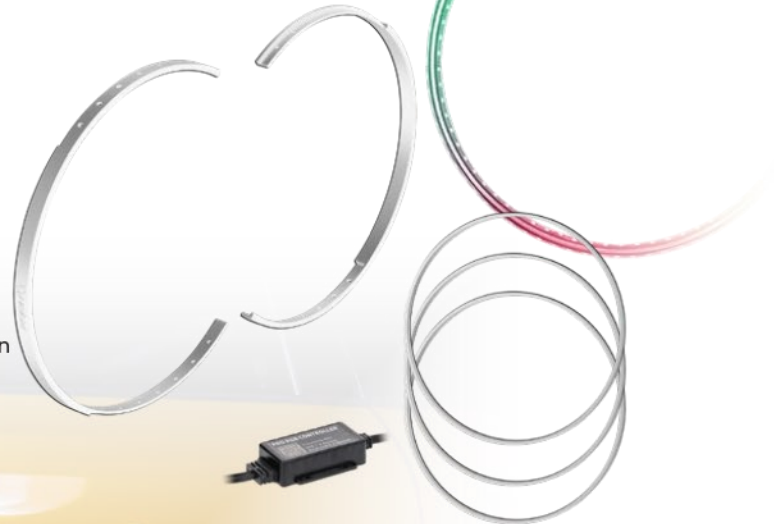

**HEISE CONNECT
FREE APP**
for smartphones
and tablets



RGBW LED WHEEL LIGHT KITS

Our RGBW wheel light kits boast sturdy metal frames that are lined on two sides with IP68 rated LEDs that will give the bright glow needed to highlight custom rims. Add in Metra's universal RGB or RGBW underglow LED lighting kits and you will not go unnoticed! Rated IP68, these lights are designed for the elements! An Installation video can be found online at HeiseLED.com

UNIVERSAL

RGBW LED WHEEL LIGHT KITS

★ IP67 ★
CERTIFIED

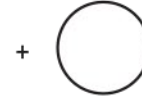

TRUE
WHITE LEDs

HE-RGBW1-W14 14 INCH

HE-RGBW1-W155 15.5 INCH

HE-RGBW1-W17 17 INCH



- 4 durable anodized aluminum wheel rings
- RGB + true white LEDs
- Double-sided LED strips that will vibrantly light up the vehicle's wheels
- Mounts to OE disc brake shield
- Works with HE-RGBW-CB and Heise Connect app (sold separately)
- All anodized aluminum and stainless-steel hardware included for a long-lasting installation
- Thread locking adhesive included for a worry-free installation
- IP68 rating
- Water-resistant Heise connectors
- 1-year limited warranty
- Option to turn lights red when braking, yellow for turn signals with the included connect controller
- NOTE: Vehicles that have a wheel base over 144 inches, will need extension cables. Order one (HE-CHASE-EXT2) or (HE-CHASE-EXT4) for each side



HEISE CONNECT
FREE APP
for smartphones
and tablets



MARINE TRANSOM LED LIGHTS

ML-RGBW72W

12 WATT

6 LED

★ IP68 ★
CERTIFIED



RGB LEDs



TRUE
WHITE LEDs

72W UNDERWATER TRANSOM LIGHT

- (6) 12-watt LEDs
- 5-wire RGBW
- Input Voltage: 10-30V DC
- Housing Material: stainless steel 316
- Mounting: Surface
- Works with RGBW-PT1 and HE-RGBW-CB controller with Heise Connect app (sold separately)

Light sold individually

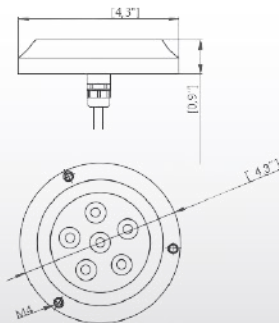

ADDITIONAL ACCESSORIES



RGBW-PT1

**4-PIN RGBW
PIGTAIL ADAPTER**



★ IP68 ★
CERTIFIED

**HE-RGBW-CB
CONTROL BOX**



**HEISE CONNECT
FREE APP**
for smartphones
and tablets





- 8mm wide, 60 LEDs per meter
- Water-resistant covering
- 3M double-sided tape provides a strong bond
- 120° viewing angle
- LED strips can be cut at every 3rd LED
- 5-meter strip only draws 1.5 amps of current
- Heise branded retail blister packaging
- White base

IP65 RATED

1 METER **60** LEDs PER METER

COLOR	RETAIL PKG	ANTI-STATIC PKG
WHITE	H-W135	HE-W135

IP65 RATED

3 METER **60** LEDs PER METER

COLOR	RETAIL PKG	ANTI-STATIC PKG
BLUE	H-B335	HE-W335
WHITE	H-W335	—

IP65 RATED

5 METER **60** LEDs PER METER

COLOR	RETAIL PKG	ANTI-STATIC PKG
BLUE	—	HE-B535
RED	—	HE-R535
WHITE	H-W535	HE-W535
COOL WHITE	H-CW535	—
WARM WHITE	H-WW535	—



- 10mm wide, 60 LEDs per meter
- Water-resistant covering
- 3M double-sided tape provides a strong bond
- 120° viewing angle
- LED strips can be cut at every 3rd LED
- 5-meter strip only draws 4.5 amps of current
- Heise branded retail blister packaging
- White base

IP65 RATED

1 METER **60** LEDs PER METER

COLOR	RETAIL PKG	ANTI-STATIC PKG
BLUE	—	HE-B150
WHITE	H-W150	HE-W150

IP65 RATED

3 METER **60** LEDs PER METER

COLOR	RETAIL PKG	ANTI-STATIC PKG
BLUE	H-B350	—
RED	H-R350	—
WHITE	H-W350	HE-W350

IP65 RATED

5 METER **60** LEDs PER METER

COLOR	RETAIL PKG	ANTI-STATIC PKG
BLUE	H-B550	HE-B550
GREEN	—	HE-G550
RED	H-R550	HE-R550
WHITE	H-W550	HE-W550
WARM WHITE	—	HE-WW550

IP68 RATED

5 METER **60** LEDs PER METER

COLOR	ANTI-STATIC PKG
WHITE	HE-W55068

- Mounts with brackets (included) instead of tape for secure mounting

ANTI-STATIC packaging ONLY

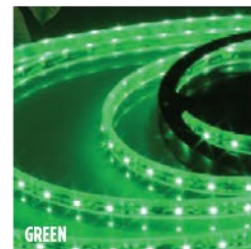

LED STRIP ACCESSORIES

HE-PS6 **6** AMP

POWER SUPPLY

- 12-volt 6-amp power supply for RGB LEDs and controllers



HE-PS10 **10** AMP

POWER SUPPLY

- 12-volt 10-amp power supply for RGB LEDs and controllers



HE-FQC5PK **2** WIRE

FEMALE 2-WIRE CONNECTOR

- Female two-wire to connector adapter
- Allows simple plug-in to LED lights from a power and ground wire
- 5 PACK



HE-MQC5PK **2** WIRE

MALE 2-WIRE CONNECTOR

- Male two-wire to connector adapter
- Allows simple plug-in to LED lights from a power and ground wire
- 5 PACK



ALUMINUM SURFACE MOUNT TRACK

3 FOOT

HE-ATCL CLEAR, SURFACE MOUNT

HE-ATFL FROSTED, SURFACE MOUNT

HE-ATCLIPS **10** PACK

- To be used with the HE-ATFL or HE-ATCL tracks

- Aluminum surface mount track available in both clear and frosted cover for use with the 3528 and 5050 LED strip lights
- Provides a decorative look and secure place to attach your LED strip lights
- Hardware included



HE-ATCL



HE-ATMCL



HE-ATFL

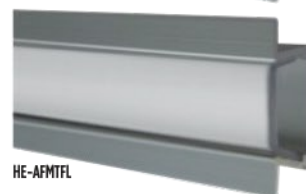

HE-ATMFL

ACCENT LIGHTS

Black or silver aluminum accent lights come in 6 colors; white, blue, red, yellow, green and purple. 3-watt COB LED, IP65-rated, and sold in pairs. Great for lighting up foot wells or highlighting installations.

**★ IP65 ★
CERTIFIED**



3 WATT **0.75" BLACK FACE**

HE-BALW WHITE

HE-BALB BLUE

HE-BALR RED

HE-BALY YELLOW

HE-BALG GREEN

HE-BALPP PURPLE



3 WATT **0.75" SILVER FACE**

HE-SALW WHITE



ACCENT LIGHTS



WHITE LED

HE-TL1 **1.5x3** INCH **3** LED ***IP68*** **CERTIFIED**

SINGLE AUXILIARY LIGHT POD

White: (3) 5-watt LEDs • **Wattage:** 15W
Color: (3) 3-watt LEDs • **Wattage:** 9W

CONSTRUCTION

Housing Material: Black Die-Cast Aluminum Housing
Hardware: Black Screws

OPERATION

Current Consumption @ 13.8 Volts: .2A

Pods sold individually



WHITE LED

HE-ML1 **1.5x3** INCH **3** LED ***IP68*** **CERTIFIED**

SINGLE AUXILIARY LIGHT POD

White: (3) 5W LEDs • **Wattage:** 15W
Color: (3) 3W LEDs • **Wattage:** 9W

CONSTRUCTION

Housing Material: White Die-Cast Aluminum Housing
Hardware: Stainless 316

OPERATION

Current Consumption @ 13.8 Volts: .2A

Pods sold individually



COMMON FEATURES

INPUT VOLTAGE: 10-30V DC	LENS MATERIAL: POLYCARBONATE
BEAM PATTERN: 120° FLOOD	MOUNTING: TWO RUBBER BASES INCLUDED
RAW LUMENS: 1200LM (WHITE)/720LM (COLOR)	OPERATING TEMPERATURE: -40°F TO +140°F
COLOR: 3-3W LEDs	IP RATING: IP68

ADDITIONAL ACCESSORIES

ACCENT LIGHTING COVERS



HE-TL1DIV

The light cover is for use with the HE-TL1, HE-TL1R, HE-TL1B, HE-TL1A and HE-TL1G



HE-ML1DIV

The light cover is for use with the HE-ML1,

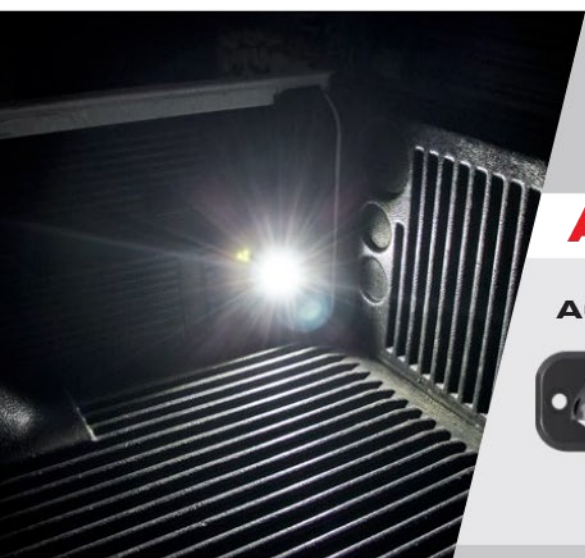

ACCENT LIGHTS

HE-FMTL1

1.5x3 INCH

3 LED

★ IP68 ★
CERTIFIED

SINGLE FLUSH MOUNT AUXILIARY LIGHT POD

Input Voltage: 10-30V DC

White: (3) 5-watt LEDs • **Wattage:** 15W

Raw Lumens: 1200lm • **Beam Pattern:** 120° Flood

CONSTRUCTION

Housing Material: Black Die-Cast Aluminum Housing

Lens Material: PC • **Hardware:** Black Screws

Mounting: Cutout Template and Gasket Included

OPERATION

Operating Temperature: -40°F to +140°F

Current Consumption @ 13.8 Volts: .2A

Pods sold individually



WHITE LED

MARINE ACCENT LIGHT KIT



9 LIGHTS

19 LEDs

PLASTIC BEZEL

★ IP67 ★
CERTIFIED

ML-ALCK9-W WHITE

ML-ALCK9-B BLUE

- Low current (0.21 amp total draw)
- Retail packed with "Try me" switch
- 6 mini stainless steel accent lights
- 3 utility lights with high-impact plastic
- Corrosion-resistant tinned wire
- Installation hardware included



*Visit HeiseLED.com for up-to-date vehicle specific applications • 386.257.2936

MARINE ACCENT LIGHTS

1 LIGHT

2 LED

STAINLESS STEEL BEZEL ★ IP67 ★ CERTIFIED

ML-AL2SS-W WHITE

ML-AL2SS-B BLUE

- Low current (0.03 amp total draw)
- Universal application
- Mini stainless steel accent lights
- Corrosion-resistant tinned wire
- Installation hardware included



1 LIGHT

2 LED

CLEAR PLASTIC BEZEL

ML-AL2CL-W WHITE

ML-AL2CL-B BLUE

- Easy, universal 2-wire installation
- Utility lights with high-impact plastic
- Corrosion-resistant tinned wire
- Installation hardware



1 LIGHT

4 LED

CHROME PLASTIC BEZEL

ML-AL4CL-W WHITE

ML-AL4CL-B BLUE

- Low current (0.01 amp total draw)
- Easy, universal 2-wire installation
- Utility lights with high-impact plastic
- Corrosion-resistant tinned wire
- Installation hardware included







VEHICLE HEADLIGHT REPLACEMENT

5x7 INCH **17** LED **★ IP67 ★ CERTIFIED**

HE-5X7B1 BLACK FRONT FACE

Wattage: 85W • **Current Consumption @ 13.8V:** Low beam - 4.3A
Current Consumption @ 13.8V: High beam - 6.2A
Raw Lumens: Low beam - 2400lm • **Raw Lumens:** High beam - 3500lm
Sold as a pair



5x7 INCH **17** LED **★ IP67 ★ CERTIFIED**

HE-5X7S1 SILVER FRONT FACE

Wattage: 85W • **Current Consumption @ 13.8V:** Low beam - 4.3A
Current Consumption @ 13.8V: High beam - 6.2A
Raw Lumens: Low beam - 2400lm • **Raw Lumens:** High beam - 3500lm
Sold as a pair



7 INCH **21** LED **ROUND WITH PARTIAL HALO ★ IP67 ★ CERTIFIED**

JP-704B BLACK FRONT FACE PAIR

Wattage: 105W • **Current Consumption @ 13.8V:** Low beam - 5.1A
Current Consumption @ 13.8V: High beam - 9.35A
Raw Lumens: Low beam - 3000lm • **Raw Lumens:** High beam - 5500lm

- White partial angel eye halo connects to running lights and flashes amber with turn signal connection
- Values are for the set

Sold as a pair



VEHICLE HEADLIGHT REPLACEMENT

HEISE CONNECT
FREE APP

7 INCH

6 LED

★ IP67 ★
CERTIFIED



RGB LEDs

JP-704RGB RGB BLACK FRONT FACE

Wattage: 150W • **Current Consumption @ 13.8V:** Low beam - 3.74A

Current Consumption @ 13.8V: High beam - 6.8A

Raw Lumens: Low beam - 2200lm • **Raw Lumens:** High beam - 4000lm

- Number of RGB LEDs (per light): 15 LEDs, 0.6W/LED
- Number of Halo LEDs (per light): white - 16 LEDs, 1.5W/LED amber - 16 LEDs, 0.2W/LED
- Requires HE-RGB-CB control box for operation (sold separately)

Sold as a pair



4 INCH

15 LED

★ IP67 ★
CERTIFIED



RGB LEDs

JP-704RGBFL RGB BLACK FRONT FACE FOG LIGHTS

Wattage: 60W • **Current Consumption @ 13.8V:** 1.6A

Raw Lumens: 1600lm

- Standard 9145 connector
- LED color temp 6500K
- Number of RGB LEDs (per light): 6 LEDs, 0.2W/LED
- Number of Halo LEDs (per light): 12 LEDs, 0.2W/LED
- Requires HE-RGB-CB control box for operation (sold separately)

Sold as a pair



COMMON FEATURES

HOUSING: DIE-CAST ALUMINUM

LED COLOR: 6500K

LENS: POLYCARBONATE

ADDITIONAL ACCESSORIES

FOR HEISE RGB AND 704RGB HEADLIGHTS/FOG LIGHTS

HE-RGB-CB RGB CONTROL BOX

- Addressable LED controller
- 170+ color-changing patterns
- Turn signal function (both left and right)
- Brake function
- DIY pattern function
- Music sync function
- App controlled (Heise Connect app) or via the included RF card remote
- Max load 10A
- Can be grouped in the app with any Heise Connect controller (RGB, RGBW, and Chasing)



HEISE CONNECT
FREE APP
for smartphones
and tablets



VEHICLE HEADLIGHT REPLACEMENT

7 INCH **6** LED **★ IP67 ★ CERTIFIED** RGB LEDS

HE-PBHL702RGB **BLACK FRONT FACE W/ FULL RGB HALO**

Wattage: 60W • **Current Consumption @ 13.8V:** Low beam - 1.9A
Current Consumption @ 13.8V: High beam - 2.7A
Raw Lumens: Low beam - 2,000lm • **Raw Lumens:** High beam - 3000lm

- Standard H4 connector
- Requires RGB-CB3 control box for operation (sold separately)

Sold as a pair



4 INCH **3** LED **★ IP67 ★ CERTIFIED** RGB LEDS

HE-JWBFL02RGB **BLACK FRONT FACE FOG LIGHTS W/ FULL RGB HALO**

Wattage: 30W • **Current Consumption @ 13.8V:** Halo off - 1.4A
Current Consumption @ 13.8V: Halo on - 1.6A
Raw Lumens: Low beam - 2,000lm • **Raw Lumens:** High beam - 1200lm

- Standard 9145 connector
- Connect to running lights
- Requires RGB-CB3 control box for operation (sold separately)

Sold as a pair

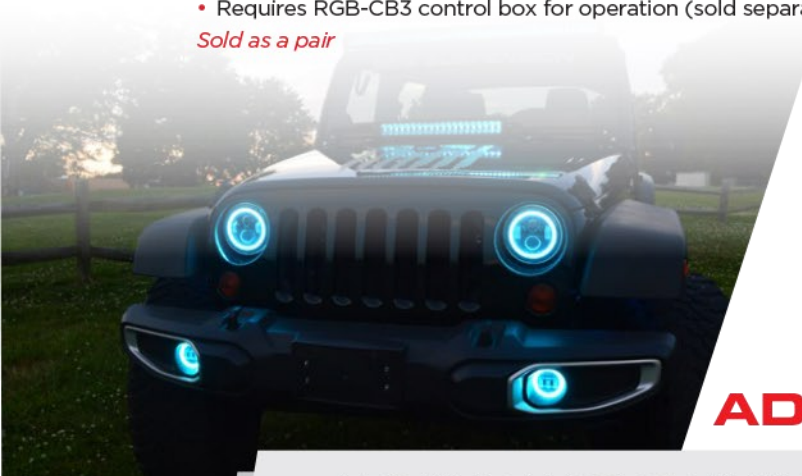

COMMON FEATURES

HOUSING: DIE-CAST ALUMINUM ALLOY

LED COLOR: 6500K

LENS: POLYCARBONATE

ADDITIONAL ACCESSORIES

FOR HEISE 702RGB HEADLIGHTS AND FLO2RGB FOG LIGHTS

RGB-CB3 **4 TRIGGERS** **RGB CONTROL BOX**

- App controlled on smart phones and tablets
- 16 million color options
- Group multiple devices
- Camera color capture
- Sync lighting to your music
- Rainbow, water and fire patterns
- Fade, blink and pulsating transitions
- 4 programmable triggers
- Handles up to 10 amps of lights



JP-707RGBKT

CHASING HALO LED 7" HEADLIGHTS & 4" FOG LIGHTS W/ CONTROLLER

★ IP68 ★
CERTIFIED



HEADLIGHT FEATURES:

- Pair of 7" headlights
- 50 watts each
- Lumens: 4200lm (high beam), 3200lm (low beam)
- Color Temperature: 6500K
- Material: Die-cast aluminum alloy housing
- Lens: Polycarbonate
- IP68 rating
- Operating Voltage: 10-32V
- (2) H4 to H13 connectors included
- CANBUS decoders included



FOG LIGHT FEATURES:

- Pair of 4" LED fog lights
- 30 watts each
- Lumens: 3600lm
- Color Temperature: 6500K
- Material: Die-cast aluminum alloy housing
- Lens: Polycarbonate
- IP68 rating
- Chase lights are for off-road use only, and not for use on public roads
- Chasing products are not compatible with other RGB or RGBW products



Heise Connect chasing controller included

JP-708RGBKT

CHASING RGB 7" PROJECTOR LIGHTS & 4" FOG LIGHTS W/ CONTROLLER

★ IP68 ★
CERTIFIED



HEADLIGHT FEATURES:

- Pair of 7" projector headlights
- 55 watts each
- Lumens: 8000lm (High beam), 6000lm (Low beam)
- Color Temperature: 6500K
- Material: Die-cast aluminum alloy housing
- Lens: Polycarbonate
- IP68 rating
- Operating Voltage: 10-32V
- (2) H4 to H13 connectors included
- CANBUS decoders included



FOG LIGHT FEATURES:

- Pair of 4" halo LED fog lights
- 30 watts each
- Lumens: 3600lm
- Color Temperature: 6500K
- Material: Die-cast aluminum alloy housing
- Lens: Polycarbonate
- IP Rating: IP68
- Chase lights are for off-road use only, and not for use on public roads
- Chasing products are not compatible with other RGB or RGBW products



Heise Connect chasing controller included

**HEISE CONNECT
FREE APP**

JEEP LIGHTING ACCESSORIES

1997-UP* JEEP WRANGLER JL
2020-UP* JEEP GLADIATOR JT

JP-709RGB

**7" PREMIUM CHASING LED
HEADLIGHTS - SEALED LIGHTS**

**★ IP68 ★
CERTIFIED**



CHASING
LED

- Wattage: 49W (per light)
- Lumens: 3000lm (high beam), 1900lm (low beam)
- Color Temperature: 6500K
- Material: Die-cast aluminum alloy housing
- Lens: Polycarbonate
- IP67K rating
- Operating Voltage: 12V
- Operating Temperature: -40°F to 140°F
- H4 to H13 connectors included
- JP-JLB7 adapter bracket is required for the JL and JT

Heise Connect chasing controller included



2018-UP* JEEP WRANGLER JL
2020-UP* JEEP GLADIATOR JT

JP-901RGBKT

**9" PREMIUM CHASING LED
HEADLIGHTS - HEADLIGHT ASSEMBLY**

**★ IP68 ★
CERTIFIED**



CHASING
LED

- Wattage: 64W (per light)
- Lumens: 4300lm (high beam), 2100lm (low beam)
- Color Temperature: 6500K
- Material: Reinforced polypropylene housing
- Lens: Polycarbonate
- IP67K rating
- Operating Voltage: 12V
- Operating Temperature: -40°F to 140°F
- Direct bolt-on replacement
- Plugs into OE harness
- CANBUS decoders included

Heise Connect chasing controller included



JEEP LIGHTING ACCESSORIES

HEISE CONNECT
FREE APP

2018-UP* JEEP WRANGLER JL
2020-UP* JEEP GLADIATOR JT

JP-RGBKT-1 COMPLETE LIGHTING KIT

★ IP67 ★
CERTIFIED



UPDATED

- Choose from 16 million different color options using the Heise Connect app with pre-built lighting transitions, flash patterns, and more
- Includes:
 - (2) 48" and (2) 36" LED underglow tubes
 - (1) 10" and (1) 18" LED grille tubes
 - 4 LED wheel-well rock lights
 - (4) 10" LED interior foot-well tubes
 - JP-APJLJT accessory quick connect
- Dual interior and exterior connections to the controller for maximum current and even illumination
- Mounting hardware and extension cables included
- In-depth installation guide included
- Full kit current draw: 4.5A @13.8V
- IP67 rating
- Expandable with Heise Infinite Series RGB lighting

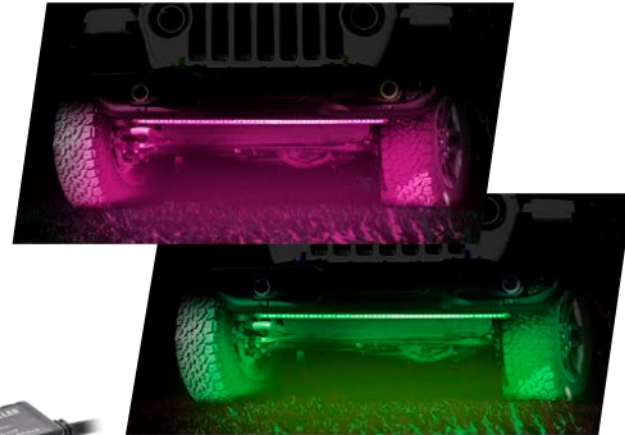

HEISE CONNECT
FREE APP
for smartphones
and tablets



2010-UP* JEEP WRANGLER FOG LIGHT HARNESS

JP-JWFLAH 2 PACK 9145 CONNECTOR TO PSX24W CONNECTOR

- Adapter harness for fog lights
- Adapts 9145 connector to PSX24W connector
- Use with fog lights JP-701FLS, JP-701FLB, JP-702FLB, JP-704RGBFL or JP-706RGBFL
- Makes connections plug-n-play
- Comes 2 in a package



JEEP LIGHTING ACCESSORIES

2007-2018 JEEP WRANGLER JK

JP-H4H13DE **2** PACK H4 CONNECTOR TO H13 CONNECTOR

- Includes CANBUS decoder to eliminate bulb out light and flickering of headlight
- Comes as a set: 2 adapters and 2 CANBUS decoders



2018-UP* JEEP WRANGLER JL
2020-UP* JEEP GLADIATOR JT

JP-LAH1 **LIGHTING CONTROL HARNESS**

- Add additional lighting accessories safely and with ease
- Taps into DRL and running light circuits with pre-wired T-harness
- Pre-wired relays included to keep your OE circuits from being overloaded
- 12 gauge power wire leading to the vehicles battery with 30 amp in-line fuse
- 2 quick-disconnect accessory plugs with 15 amp fuses in each



2018-UP* JEEP WRANGLER JL
2020-UP* JEEP GLADIATOR JT

JP-TSH1 **JEEP JL/JT FENDER LIGHT HARNESS**

- Provides a trigger (turn-on) for your parking light, DRL, or turn signal
- Harness is easily installed
- Easy to read wire labels
- Works for JL/JT without factory LED headlights
- Makes installing aftermarket headlights painless
- Recommended for use with JP-RGBKT-1, JP-707RGBKT or JP-708RGBKT

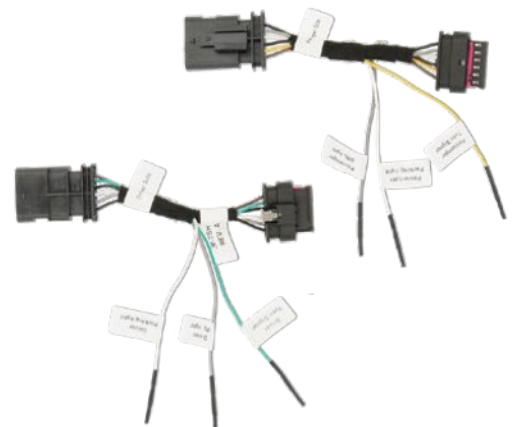

2018-UP* JEEP WRANGLER JL
2020-UP* JEEP GLADIATOR JT

JP-APJLJT **POWER OUTLET ACCESSORY T-HARNESS**

- Easy to install accessory harness
- Works in both two and four door models
- No splicing required
- Plugs into the back of the lower dash power port
- 10 amp fuse included to protect your added accessory



SEQUENTIAL TAILGATE BAR TURN/RUN/BRAKE/REVERSE

HE-STGB48

48 INCH

810 LED

★ IP67 ★
CERTIFIED

270 RED LEDS, 270 AMBER LEDS, 270 WHITE LEDS

HE-STGB60

60 INCH

1080 LED

★ IP67 ★
CERTIFIED

360 RED LEDS, 360 AMBER LEDS, 360 WHITE LEDS

- Pickup truck tailgate LED bar
- Stop/turn/running light/reverse functions
- Sequential turn signals
- Pre-wired 4-pin trailer harness included for simple plug-n-play installation
- Reverse wire can be hardwired in if so desired
- Hardwire adapter for 4-pin trailer harness included
- Sealed lightbar prevents moisture and dust from entering
- Mounts with 3M tape, so no drilling required
- Operating Temperature: -40°F to 140°F
- Input Voltage: 12VDC
- Protections: Reverse Polarity
- IP67 rating



TURN / RUNNING / BRAKE LIGHTS

H-TTLB48

48 INCH

48 LED

H-TTLB60

60 INCH

60 LED

TAILGATE LIGHTBAR

- Pickup truck stop/turn/running light/reverse tailgate LED lightbar
- Pre-wired 4-pin trailer harness included for simple plug-n-play installation
- Reverse wire can be hard-wired in if so desired
- Sealed lightbar prevents moisture and dust from entering
- Mounts with 3M tape so no drilling required
- IP65 rating



2021 FORD BRONCO

HE-FDSTL

SPARE TIRE LIGHT

- (85) 1-watt LEDs
- Brake light
- 2-wire hookup



JEEP RUNNING / BRAKE LIGHTS

2007-2018 JEEP WRANGLER JK
2018-UP* JEEP WRANGLER JL

JP-STL

85 WATTS

85 LED

★ IP67 ★
CERTIFIED

LED SPARE TIRE LIGHT

- (85) 1-watt LEDs
- Brake light

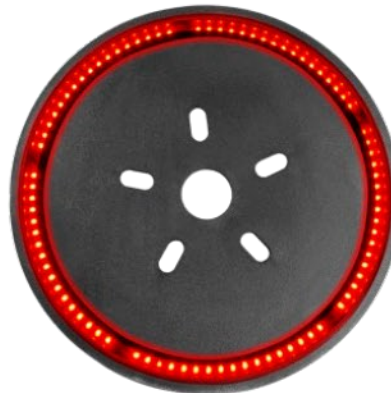

2007-2018 JEEP WRANGLER JK

JP-TL01S

19 WATTS

32 LED

★ IP67 ★
CERTIFIED

SMOKED LENS GRID TAILLIGHT

- Turn signal (14) 1-watt LEDs, brake light (6) .5-watt LEDs and running light (12) .2-watt LEDs (each)
- Smoked lens
- OEM fit
- Plugs into OEM harness
- Polycarbonate lens

Sold as a pair



2007-2018 JEEP WRANGLER JK

JP-TL03T

42 WATTS

21 LED

★ IP67 ★
CERTIFIED

LED LUX TAILLIGHT

- Turn signal, brake light, and running light (21) 1-watt LEDs (each)
- 30-watt high-output reverse light
- Gives your Jeep Wrangler a rugged look
- OEM fit
- Plugs into OEM harness
- Polycarbonate lens

Sold as a pair



COMMON FEATURES

USAGE: PLUGS INTO OEM HARNESS **LED COLOR:** 2000K **IP RATING:** IP67

JEEP TAILLIGHT REPLACEMENT

2018-UP* JEEP WRANGLER JL

JP-TL05S

51 WATTS

90 LED

**★ IP67 ★
CERTIFIED**

TAILLIGHT - SMOKED

- Smoked lens
- Brake LEDs: (42) 0.2W
- Running LEDs: (42) 0.2W
- Reverse LEDs: (6) 1.5W
- OE connector
- Mounts to OE location with OE hardware
- Lens: Polycarbonate
- Membrane: Dual military breather
- Operating Temperature: -40°F to 140°F
- Input Voltage: 12VDC
- IP67 rating

Sold as a pair



2020-UP* JEEP GLADIATOR JT

JP-TL06S

64 WATTS

52 LED

**★ IP67 ★
CERTIFIED**

TAILLIGHT - SMOKED

- Smoked lens
- Brake LEDs: (18) 0.5W
- Running LEDs: (28) 0.5W
- Reverse LEDs: (6) 1.5W
- OE connector
- Mounts to OE location with OE hardware
- Lens: Polycarbonate
- Membrane: Dual military breather
- Operating Temperature: -40°F to 140°F
- Input Voltage: 12VDC
- IP67 rating

Sold as a pair



JEEP MARKER LIGHT REPLACEMENT

2018-UP* JEEP WRANGLER JL
2019-UP* JEEP GLADIATOR JT

JP-SML2 **13.5** WATTS **27** LED **★ IP67 ★
CERTIFIED**

LED SIDE MARKERS

The smoked crystalline lens provides a stylish upgrade and the amber LEDs provide better visibility with 13.5 watts and an internal reflector for an even brighter output than the factory marker lights.

- (27) 0.5-watt LEDs (each)
- Color temperature: 2000K
- Smoked crystalline lens
- Amber LED
- Multi-angle internal reflector
- Integrated anti-flicker
- Plug-n-play factory connector

Sold as a pair



2018-UP* JEEP WRANGLER JL SPORT
2020-UP* JEEP GLADIATOR JT SPORT

JP-TSS-S **96** WATTS **48** LED

JEEP JL/JT SPORT TURN SIGNAL LIGHT SMOKED - SEQUENTIAL TURN SIGNAL

- 30 white running LEDs
- 18 amber sequential flash LEDs
- Rebreather-style ventilation

Sold as a pair



JEEP MARKER LIGHT REPLACEMENT

2018-UP* WRANGLER JL RUBICON
2020-UP* JEEP GLADIATOR JT

JP-TSR-S **96** WATTS **48** LED

JEEP JL/JT RUBICON TURN SIGNAL LIGHT SMOKED - SEQUENTIAL TURN SIGNAL

- 30 white running LEDs
- 18 amber sequential flash LEDs
- Rebreather-style ventilation
- Not compatible with dual halogen Sahara/Rubicon models

Sold as a pair



2007-2018 JEEP WRANGLER JK

JP-SML1 **4** WATTS **8** LED **★ IP67 ★
CERTIFIED**

LED SIDE MARKERS

- (8) 0.5-watt amber LEDs each
- Color Temperature: 2000K
- Water-resistant
- OEM fit
- Plugs into OEM harness
- Polycarbonate lens

Sold as a pair



2007-2018 JEEP WRANGLER JK

JP-TSL1 **4** WATTS **8** LED **★ IP67 ★
CERTIFIED**

LED TURN SIGNAL

- (8) 0.5-watt amber LEDs each
- Color Temperature: 2000K
- Water-resistant
- OEM fit
- Plugs into OEM harness
- Smoked polycarbonate lens

Sold as a pair



LED BULBS



LED **25 WATTS PER BULB**

SINGLE BEAM

DUAL BEAM

★ IP67 ★
CERTIFIED

- 2nd generation LED chipset
- 6500K color temperature with 3000K & 8000K films
- 6000 lumens
- 25 watts per bulb (single beam kits)
- IP67 rating
- Operating Temperature: -40°F to 176°F

Sold in pairs

HE-H1LED	HE-H16LED	HE-PSX24LED
HE-H3LED	HE-5202LED	HE-PSX26LED
HE-H7LED	HE-880LED	
HE-H8LED	HE-9005LED	
HE-H9LED	HE-9006LED	
HE-H10LED	HE-9012LED	
HE-H11LED		

HE-H4LED
HE-H13LED
HE-9004LED
HE-9007LED

* Keep your original factory bulbs so that you can replace them for use on public roads. Keep the box that the new bulbs came in to store the bulbs and be sure to handle them with care when removing and re-installing



CANBUS DECODERS

- Use with vehicles that have CANBUS systems that monitor the headlights
- Stops the headlights from flashing and have simple plug-n-play connections

Sold in pairs



PACKAGED PAIR

HE-H4D	HE-9007D	HE-H10D	HE-9005D	HE-5202D
HE-H13D	HE-H7D	HE-H11D	HE-9006D	HE-H1D

LOAD RESISTOR

HE-LR **50 WATTS** **1 PAIR**

6 OHM LOAD RESISTOR

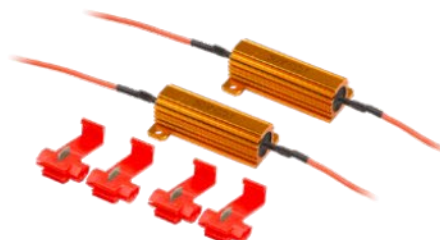

LED BULBS PROJECTOR SERIES

Better Night Driving Begins with Heise

We've perfected high-performance LED lights for almost every type of vehicle and use. Now, you can upgrade any car or truck with projector bulbs to use our ultra-efficient, brighter LED bulbs. These are designed and optimized specifically for projector housings, but with the benefit of an instantaneous full lumen start-up, efficient LED output, and longer lifespan. Plus, they're easy to install and have a built-in EMI filter to avoid any potential radio reception interference.

BULBS LED PROJECTOR

- LED bulbs
- Optimized specifically for projector housings
- Instantaneous full lumen start-up
- 10,000 lumens*
- 9-32V DC
- 80 watts*
- Built-in EMI filter so it will not affect the vehicle's radio reception
- Side-cable connection for slimmer installation
- Tool-less rotatable collar for beam pattern adjustment
- Copper-backed PCB
- Intelligent temperature system
- Copper heat pipe cooling
- Dual ball bearing fan

* Rating for bulb set

Sold in pairs

10,000
LUMENS | 80W

INCLUDES 2
BULBS

FOR
PROJECTOR
HOUSING
ONLY

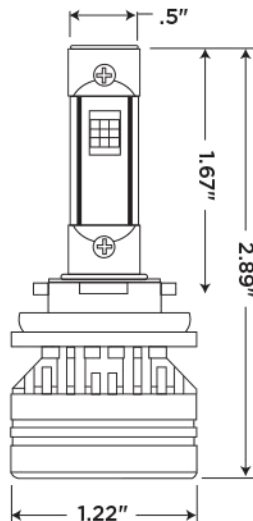

NOT FOR USE
ON PUBLIC ROADS

Keep your original factory bulbs so that you can replace them for use on public roads. Keep the box that the new bulbs came in to store the bulbs and be sure to handle them with care when removing and re-installing.



HE-9005X

Fits: 9005



HE-9006X

Fits: 9006



HE-H7X

Fits: H7



HE-H11X

Fits: H11



LED BULBS PRO SERIES - HID

16,000
LUMENS | 70W

260%
BRIGHTER THAN
OTHER LEDS

HID to LED CONVERSION

Heise's HID to LED conversion bulbs cover every application of HID currently available on the market. Matched with a brand new extreme LED chipset, they not only outlast but will outperform HID bulbs. These bulbs are meticulously designed optimizing the LED position to maximize the headlight housing optics for both projector and reflector systems.

The "C" designation given to these bulb is in reference to the unique collar design that allows them to be properly keyed into projector "S" housings and reflector "R" housings.

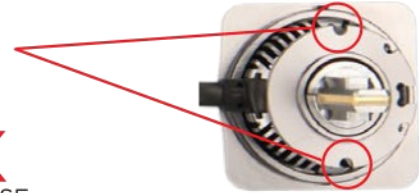

NOT FOR USE
ON PUBLIC ROADS

- Keep your original factory bulbs so that you can replace them for use on public roads. Keep the box that the new bulbs came in to store the bulbs and be sure to handle them with care when removing and re-installing

Sold in pairs

HE-D1CPRO

FITS: D1S & D1R



HE-D2CPRO

FITS: D2S & D2R



HE-D3CPRO

FITS: D3S, D3R & D8S



HE-D4CPRO

FITS: D4S & D4R



HE-D5CPRO

FITS: D5S & D5R



LED BULBS PRO SERIES SINGLE & DUAL BEAM

260%
BRIGHTER THAN
OTHER LEDS

NOT FOR USE
ON PUBLIC ROADS

SINGLE BEAM

SINGLE BEAM & DUAL BEAM

- 16,000 lumens / 70 watts* / 6500K color temp
- 260% brighter than other LED bulbs
- Built-in reverse polarity protection
- Side cable connection for slimmer installation
- IC Thermal controller with high speed smart fan
- 2mm solid copper thermodynamic core
- Rotatable collar for beam pattern adjustment
- IP65 rating

- Instantaneous full lumen start-up
- Voltage: 12V-24V
- Keep your original factory bulbs so that you can replace them for use on public roads. Keep the box the new bulbs came in to store bulbs and be sure to handle them with care when removing and re-installing

* Rating for bulb set

Sold in pairs



HE-H1PRO



HE-H3PRO



HE-H7PRO



HE-H8PRO



HE-H9PRO



HE-H10PRO



HE-H11PRO



HE-H16PRO



HE-5202PRO



HE-9005PRO



HE-9006PRO



HE-9012PRO



HE-PSX24PRO



HE-PSX26PRO



HE-880PRO



HE-881PRO



HE-P13PRO

DUAL BEAM



HE-H4PRO



HE-H13PRO



HE-9004PRO



HE-9007PRO

*Visit HeiseLED.com for up-to-date vehicle specific applications • 386.257.2956

AUXILIARY LIGHTING

HE-DRL2PK-55 **5.5** INCH **2** PACK

- Self-adhesive
- LED color: White
- Voltage: 12V DC



HE-DRL2PK-67 **6.7** INCH **2** PACK

- Self-adhesive
- LED color: White
- Voltage: 12V DC



TURN / BRAKE / BACKUP BULBS

INTEGRATED INTERNAL CANBUS SYSTEM

REPLACEMENT BULBS **2** PACK



COLOR / T10 APPLICATIONS

WHITE / HE-CT10W

AMBER / HE-CT10A



COLOR / T15 APPLICATIONS

WHITE / HE-CT15W



COLOR / 1157 APPLICATIONS

WHITE / HE-C1157W



COLOR / 7440 APPLICATIONS

WHITE / HE-C7440W



COLOR / 7443 APPLICATIONS

WHITE / HE-C7443W

BULB REPLACEMENT GUIDE



7443



7443



MOTORCYCLE®
**Saddle
Tramp**
ACCESSORIES

SADDLE TRAMP

SADDLE TRAMP



MOTORCYCLE HEADLIGHTS

7 INCH **9** LED **ROUND**

BC-701B BLACK FRONT FACE

BC-701S SILVER FRONT FACE

- Wattage: (9) 5-watt LEDs for a total of 45 watts
- Low Beam: 2400
- High Beam: 3600
- Color Temperature: 6500K
- Aluminum housing, polycarbonate lens
- Connector: H4



7" REFLECTOR HEADLIGHT W/FULL HALO

BC-709B

1998-2022

FITS HARLEY-DAVIDSON STREET GLIDE MODELS

NEW

- Improved heatsink design
- Upgraded optics
- Low Beam: 2000lm, 20W
- High Beam: 3400lm, 40W
- Color Temperature: 6000K
- Aluminum housing, polycarbonate lens
- Full DRL halo with amber non-direction caution indicator



4.5" REFLECTOR PASSING LIGHTS W/FULL HALO

BC-453B

1998-2022

FITS HARLEY-DAVIDSON STREET GLIDE MODELS

NEW

- Updated heatsink design for installation in tight spaces
- Upgraded optics
- 1200lm, 15W (per set)
- Color Temperature: 6000K
- Aluminum housing, polycarbonate lens

Sold as a pair



MOTORCYCLE TRIM RINGS

RETAINING RING

FITS MOST 2013-OLDER HARLEY-DAVIDSON®

7 INCH

ROUND ADAPTER

BC-HB7

CHROME FRONT FACE

- Use when replacing 7" headlights on 2013 and older Harley-Davidson® motorcycles
- Zinc plated for corrosion resistance



MOTORCYCLE ACCENT LIGHTS NEW

VENT GRILLE LIGHT - LOWER FAIRING ACCENT LIGHTS

BC-HDVL-HD2

2014-UP*

FITS HARLEY-DAVIDSON
TOURING MODELS (with hard bags)

- LED running light
- Amber or white switchback design for turn signal
- No drill, easy installation
- Includes T-Harness



SWORD SADDLEBAG LIGHT + REAR SADDLEBAG LIGHTS

BC-HDSBL-HD1

1998-2013

FITS HARLEY-DAVIDSON
TOURING MODELS (with hard bags)

- LED brake and turning lights
- Mounts to saddlebags, no drilling needed
- Includes harness
- Chrome finish to match the factory finish

Sold as a pair



MOTORCYCLE ACCENT LIGHTS

NEW

SADDLEBAG ACCENT LIGHTS + REAR SADDLEBAG LIGHTS

BC-HDSBL-HD2

2014-UP*

**FITS HARLEY-DAVIDSON
TOURING MODELS (with hard bags)**

- LED brake and turning lights
- Mounts to saddlebags, no drilling needed
- Includes harness
- Matte black finish

Sold as a pair



KEYSTONE LIGHTS - ACCENT LIGHTS

BC-HDFL-HD2

2014-UP*

**FITS HARLEY-DAVIDSON
TOURING MODELS (with hard bags)**

- LED brake and turning lights
- Mounts to the rear fender, no drilling needed
- Includes T-harness

Sold as a pair



MOTORCYCLE TAILLIGHTS

LED REPLACEMENT TAILLIGHTS

1999-UP*

FITS HARLEY-DAVIDSON

★ IP67 ★
CERTIFIED

BC-HDTL9 SMOKE LENS

- Eagle claw style
- Color: black with red lens and clear protective cover
- Light color: red brake, red running and white license plate lights
- LED color temp: 6000K - 6500K
- Light source: 20 LEDs (running & brake) + 6 LEDs (license plate)



MOTORCYCLE TURN SIGNALS

2" LONG, 3.25" ROUND BULLET-STYLE TURN SIGNAL WITHOUT RED RUNNING LIGHT

BULLET STYLE FRONT 1157 LED INSERT | FITS HARLEY-DAVIDSON

BC-1157AW

2 PACK

48 LED

- Generation II brighter, flat style LED
- 48 white LEDs, 48 yellow LEDs
- 3.25" light housing requires adapter BC-1157RING
- **2013 and earlier may require load equalizer*



ADDITIONAL ACCESSORIES



BC-1157RING

LED RING

TURN SIGNAL ADAPTER BRACKET

- Adapts BC-1157AW, BC-1157RD, BC-1156RD to fit in 3.25" light housing
- Comes with pre-installed 3M automotive-grade tape
- Made from metal alloy, with strong heat resistant adapters
- Sold as a pair



MOTORCYCLE LIGHT ACCESSORIES

NEW

16-PIECE KIT IS COMPLETELY PLUG-N-PLAY WITH OE-STYLE CONNECTIONS

BC-CHASE-K1

1998-2022

FITS HARLEY-DAVIDSON TOURING MODELS



- Water-tight, labeled connectors to make installation an ease
- RGB Strips Rated IP68 to withstand the elements
- 5050 RGB LED strips with VHB adhesive backing
- Lights controlled via Heise Connect app or included RF remote
- Pre-wired trigger control for brake lights to add extra visibility for riders
- LED strips are pre-wired for triple tree, front fender, down tubes, gas tank, back engine, lower frame, saddlebags, and Tour Pak®
- IP67-rated controller
- 1-year warranty on LED strips and RGB controller
- Installation level: Moderate

KIT INCLUDES:

- 16 RGB LED strips with adhesive backing
- RF remote
- (3) Vehicle-specific plug-n-play rear lighting T-harnesses
- Independent on/off switch that can turn lights on with the ignition off
- Alcohol prep pads, adhesive promoter, and zip ties
- Instructions

Heise Connect chasing controller included

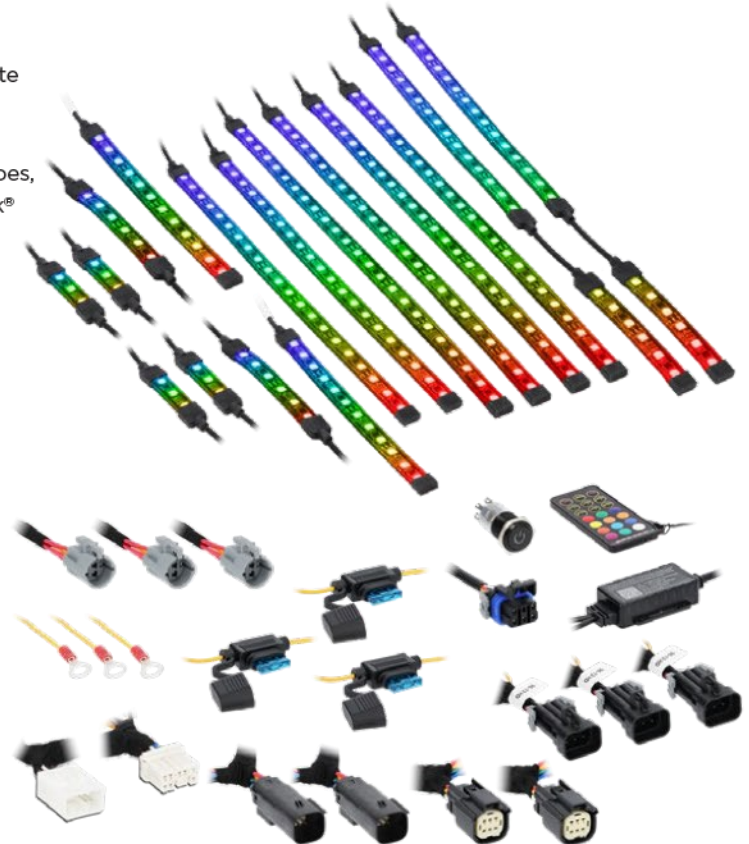

**HEISE CONNECT
FREE APP**

for smartphones and tablets



HEISE CONNECT Features:

- Addressable LEDs
- 170+ color-changing patterns
- Turn signal function + brake function
- DIY pattern function + music sync function
- Max load 10A
- Can be grouped in the app with any Heise Connect controller (RGB, RGBW, and Chasing)



MOTORCYCLE LIGHT ACCESSORIES

NEW

13-PIECE KIT IS COMPLETELY PLUG-N-PLAY WITH OE-STYLE CONNECTIONS

BC-CHASE-K2

2019-UP*

FITS CAN-AM RYKER

2019-UP*

FITS CAN-AM RYKER RALLY

2022-UP*

FITS CAN-AM RYKER SPORT



- Water-tight, labeled connectors to make installation an ease
- Rated IP68 to withstand the elements
- 5050 chasing LED strips with 3M adhesive backing
- 5050 chasing LED tube lights
- Lights controlled via Heise Connect app or included RF remote
- Pre-wired trigger control for brake lights to add extra visibility for riders
- LED strips are pre-wired strips for A-arms, skid plate, gas tank, back engine, lower frame, and swing arm
- 1-year warranty on LED strips/tubes and RGB controller
- Installation Level: Moderate

KIT INCLUDES:

- (10) 5050 chasing LED strips with 3M adhesive backing
- (3) 5050 chasing LED sealed tubes
- Vehicle-specific plug-n-play rear lighting T-harnesses: 2019-up*
Can-AM® 4-pin OE plug
- RF remote

Heise Connect chasing controller included



**HEISE CONNECT
FREE APP**

for smartphones and tablets



HEISE CONNECT Features:

- Addressable LEDs
- 170+ color-changing patterns
- Turn signal function + brake function
- DIY pattern function + music sync function
- Max load 10A
- Can be grouped in the app with any Heise Connect controller (RGB, RGBW, and Chasing)



MOTORCYCLE LIGHT ACCESSORIES

12-STRIP RGB PLUG-N-PLAY KIT WITH CONTROLLER

BC-RGB-K1

1996-UP*

FITS HARLEY-DAVIDSON FLH AND FLT WITH TOUR-PAK®

★ IP67 ★
CERTIFIED



- Kit is completely plug-n-play with OE style connections
- Water-tight connectors
- 5050 LED strips with black base
- 3M adhesive backing
- RGB colors are app controlled
- Trigger controls for brake and turn signals pre-wired

KIT INCLUDES

- Plug-n-play rear lighting T-harnesses
- 1996-2013 8-pin OE plug
- 2010-2013 6-pin OE plug
- 2014-UP* 6-pin OE plug
- Independent On/Off switch that can turn your lights on with ignition off
- RGB controller
- Alcohol prep pads, adhesive promoter and zip ties

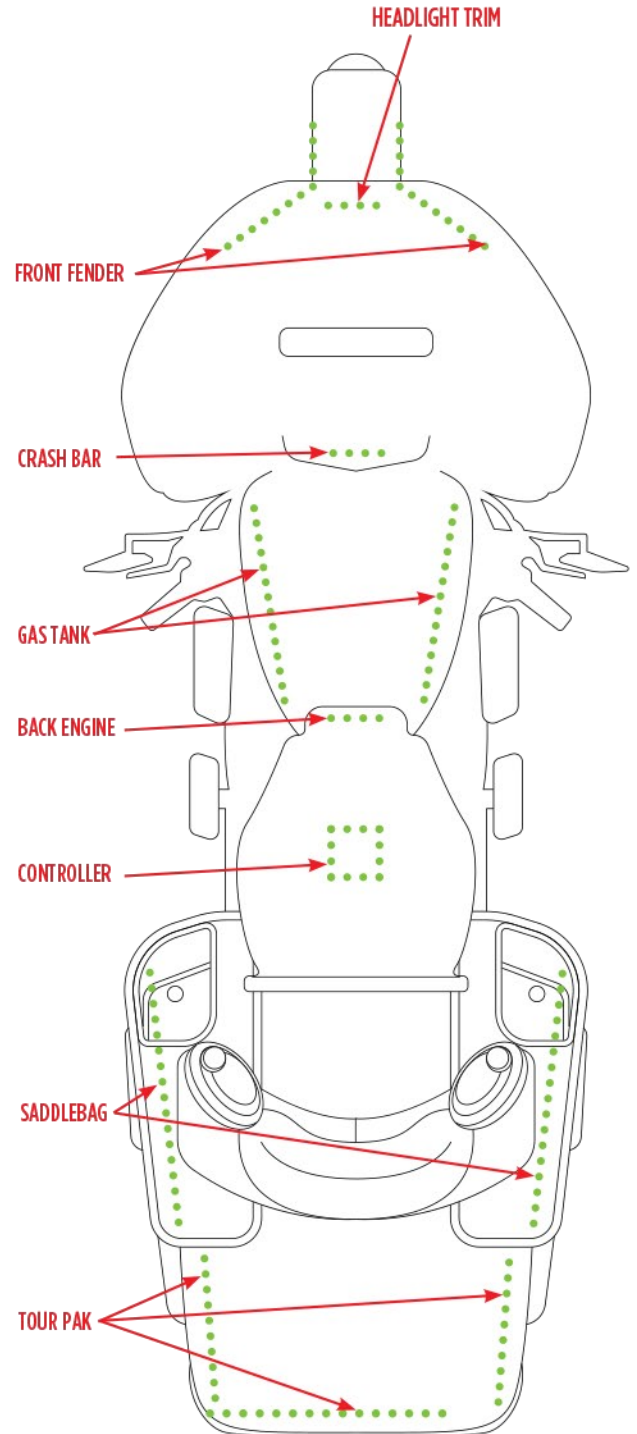

Download it FREE

*Visit HeiseLED.com for up-to-date vehicle specific applications • 386.257.2956

MOTORCYCLE LIGHT ACCESSORIES

BC-RGB-PT1

UNIVERSAL

RGB HARNESS

- Female to bare end



BC-RGB-PT2

UNIVERSAL

RGB HARNESS

- Male to bare end



BC-RGB-Y1

UNIVERSAL

RGB Y HARNESS

- 1 female to 2 male ends



BC-RGB-Y2

UNIVERSAL

RGB Y HARNESS

- 1 male to 2 female ends



MOTORCYCLE LIGHT ACCESSORIES

UNIVERSAL RGB STRIP

BC-RGB-4 4 INCH

BC-RGB-10 10 INCH

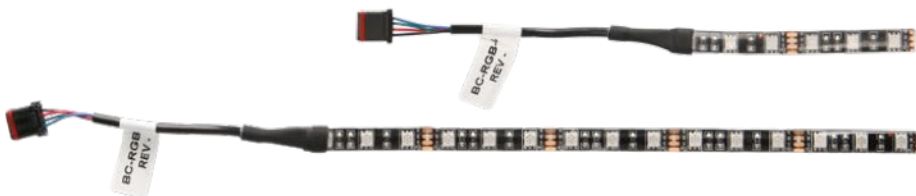

- RGB LED strip
- 3M adhesive backing
- Designed for the BC-RGB-K1 or BC-RGB-K2 (sold separately)
- Works with plug-in Y adapter BC-RGB-Y2 (sold separately)
- We also recommend using these items, sold separately, for a successful installation:
 - IBAWIPE - Alcohol prep wipes
 - 3M06396 - 3M adhesion promoter

1997-2013*

TURN SIGNAL LOAD EQUALIZER

BC-HARLE1

FITS MOST HARLEY-DAVIDSON
TOURING GLIDES, SOFTTAILS & SPORTSTERS

- Compatible with HD factory alarm
- Stops hyper flashing when adding LED turning lights
- Plug-n-play, no cutting and splicing required

Warning! Gets extremely HOT. Do not mount on plastic and make sure it's not touching any wires!

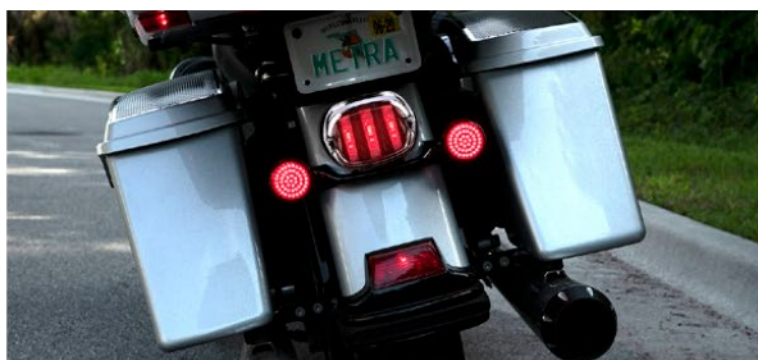
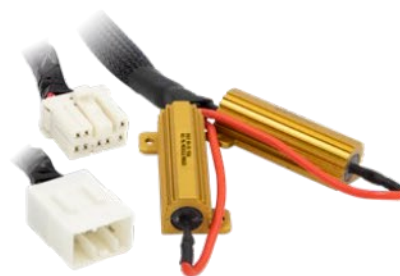

2014-UP*

MULTI-PATTERN BRAKE STROBE LIGHT

BC-HDSSF1

FITS HARLEY-DAVIDSON FLH AND FLT

- 84 watts / 7-amp selectable strobe light
- 10 selectable patterns for LED lights
- Plug-n-play installation
- Brake light flasher only



MOTORCYCLE LIGHT ACCESSORIES

1996-2013*

MULTI-PATTERN BRAKE STROBE LIGHT FLASHERS

BC-HDSSF2

FITS HARLEY-DAVIDSON FLH AND FLT

- 84 watts / 7-amp selectable strobe light
- 10 selectable patterns for LED lights
- Plug-n-play installation
- Brake light flasher only



2010-2013*

MULTI-PATTERN BRAKE STROBE LIGHT FLASHERS

BC-HDSSF3

FITS HARLEY-DAVIDSON FLH AND FLT

- 86 watts / 7-amp selectable strobe light
- 10 selectable patterns for LED lights
- Plug-n-play installation
- Brake light flasher only



2014-UP*

H4 CONNECTOR TO 4-PIN ADAPTER HARNESS

HE-H44PIN

FITS HARLEY-DAVIDSON

- Adapts H4 to 4-pin Harley-Davidson® connector
- Use when replacing the headlight
- Some splicing may be required



BRAKE LIGHT FLASHER

IBBLF

UNIVERSAL

- For use with non-LED third brake lights
- Flashes third brake light for greater visibility



STROBE FLASH CONTROLLER

IBLEDBLF

UNIVERSAL

- For use with non-LED third brake lights
- Flashes third brake light for greater visibility







POWERSPORTS CHASING ACCENT LIGHTS

CHASING LED UNDERGLOW KIT UTV, GOLF CART, ATV - CHASING LEDS

MPS-UNDG-KT1

UNIVERSAL

NEW



- 6 sealed polycarbonate LED tubes: (4) 9" & (2) 28"
- Mounting hardware & extension cables are included
- Water-resistant Heise connector
- Includes RF card remote
- Option to turn lights red when braking, and amber for turn signals with the included controller
- IP67 rated

Heise Connect chasing controller included

**HEISE CONNECT
FREE APP**



CHASING WHIP LIGHT

MPS-CHWP-1

UNIVERSAL

**HEISE CONNECT
FREE APP**

NEW



- High strength polycarbonate tube with spring located at the base of the whip for flexibility
- Quick connect base
- Water-tight connectors to withstand the elements
- Lights controlled via Heise Connect app or included RF remote
- RF card remote included
- U.S. Flag included
- IP67 rated
- 1 year warranty

Heise Connect RGBW controller included



**HEISE CONNECT
FREE APP**

for smartphones and tablets



HEISE CONNECT Features:

- Addressable LEDs
- 170+ color-changing patterns
- Turn signal function + brake function
- DIY pattern function + music sync function
- Max load 10A
- Can be grouped in the app with any Heise Connect controller (RGB, RGBW, and Chasing)



DOME LIGHT FIXTURE

MPS-DL

6 WATT

**50,000 HOURS
LIFE EXPECTANCY**

- IPX5 rated for RV, marine, UTV or any vehicle
- 12 pieces of .5 watt high output/power SMD LEDs
- Touch control On/Off and 10-step dimmer
- Color Temperature: 6000-6500K warm white



POWERSPORTS RGB ACCENT LIGHTS

POD LED STRING KIT

MPS-RGBWWK 4 ROPES 12 PODS 1 CONTROLLER



RGB LEDS

- Includes four (4) sets of LED string lights with three (3) LED light pods per string, MPS-RGBWWS4
- Includes one (1) hideaway RGB controller (MPS-RGBC-4)



RGB LED CONTROLLER

MPS-RGBC-4 20 MODES 10 SPEEDS 1 CONTROLLER



RGB LEDS

- IPX5 water-resistant RGB LED controller
- Use EZ LED app to control infinite colors, 10 speeds, and 20 dynamic modes (available for smartphones and tablets)
- LEDs flash to your music via your smartphone wireless feature
- Operational Voltage: 12-24V DC
- Maximum Current: 18A
- App Operating Range: 60ft (20m) unobstructed
- Outputs: (4) Micro-DIN male connectors
- Fused power and ground wires for easy connection
- Use with Metra PowerSports RGB LED lighting



RGB2-S1 IP68 SINGLE RGB STRING LIGHT



RGB LEDS

- 3 LED pods per strip
- 5 LEDs per pod
- 4-pin micro-DIN controller
- Works with RGB-CB2 (sold separately)



MPS-ECR36

RGB EXTENSION

- 36" RGB LED extension
- Male micro-DIN 4-pin and female micro-DIN 4-pin connectors



MPS-ECR72

RGB EXTENSION

- 72" RGB LED extension
- Male micro-DIN 4-pin and female micro-DIN 4-pin connectors
- Works with MPS-RGBWWS4 and RGB2-4KT string lights



POWERSPORTS RGB ACCENT LIGHTS

RGB-PT2

PIGTAIL ADAPTER

- 6" in length
- 4-pin RGB hardwire pigtail



RGB-Y2

RGB "Y" ADAPTER

- 6" in length
- One 4-pin female micro-DIN to two micro-DIN males



RGB2-C70M

IP66

RGB CUP HOLDER LIGHTS



RGB LEDS

- 2 RGB 2.75" rings (controller sold separately)
- 3M double-sided tape for mounting
- IP66 rated
- Works with MPS-RGBC-4



POWERSPORTS RGBW ACCESSORIES



RGBW2-72

RGBW EXTENSION

- 72" RGBW LED extension
- Male micro-DIN 5-pin and female micro-DIN 5-pin connectors



RGBW-PT2

HARDWIRE PLUG

- 6" in length
- 5-pin RGBW hardwire plug



RGBW2-Y

"Y" ADAPTER

- 6" in length
- One 5-pin female micro-DIN to 2 micro-DIN males





Metra[®]
Marine

MARINE



MARINE



MARINE TRANSOM LED LIGHTS

ML-RGBW72W

12 WATT

6 LED

**★ IP68 ★
CERTIFIED**



RGB LEDs



TRUE
WHITE LEDs

72W UNDERWATER TRANSOM LIGHT

- (6) 12-watt LEDs
- 5-wire RGBW
- Input Voltage: 10-30V DC
- Housing Material: stainless steel 316
- Mounting: Surface
- Works with RGBW-PT1 and HE-RGBW-CB controller with Heise Connect app (sold separately)

Light sold individually

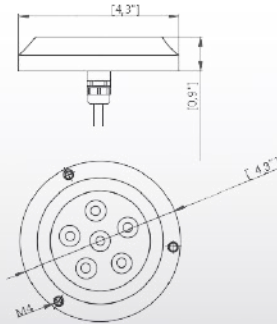

ADDITIONAL ACCESSORIES



RGBW-PT1

**4-PIN RGBW
PIGTAIL ADAPTER**



**★ IP68 ★
CERTIFIED**

**HE-RGBW-CB
CONTROL BOX**



**HEISE CONNECT
FREE APP**

for smartphones
and tablets



MARINE ACCENT LIGHTS

1 LIGHT

2 LED

STAINLESS STEEL BEZEL ★ IP67 ★ CERTIFIED

ML-AL2SS-W WHITE

ML-AL2SS-B BLUE

- Mini stainless steel accent lights
- Low current (0.03 amp total draw)
- Universal application
- Corrosion-resistant tinned wire
- Installation hardware included

Light sold individually



1 LIGHT

2 LED

CLEAR PLASTIC BEZEL ★ IP67 ★ CERTIFIED

ML-AL2CL-W WHITE

ML-AL2CL-B BLUE

- Utility lights with high-impact plastic
- Easy, universal 2-wire installation
- Corrosion-resistant tinned wire
- Installation hardware included

Light sold individually



1 LIGHT

4 LED

CHROME PLASTIC BEZEL ★ IP67 ★ CERTIFIED

ML-AL4CL-W WHITE

ML-AL4CL-B BLUE

- Utility lights with high-impact plastic
- Low current (0.01 amp total draw)
- Easy, universal 2-wire installation
- Corrosion-resistant tinned wire
- Installation hardware included

Light sold individually



MARINE ACCENT LIGHT KIT

9 LIGHTS

19 LEDs

PLASTIC BEZEL

★ IP67 ★
CERTIFIED

ML-ALCK9-W WHITE

ML-ALCK9-B BLUE

- 6 mini stainless steel accent lights
- 3 utility lights with high-impact plastic
- Low current (0.21 amp total draw)
- Retail packed with "Try me" switch
- Corrosion-resistant tinned wire
- Installation hardware included

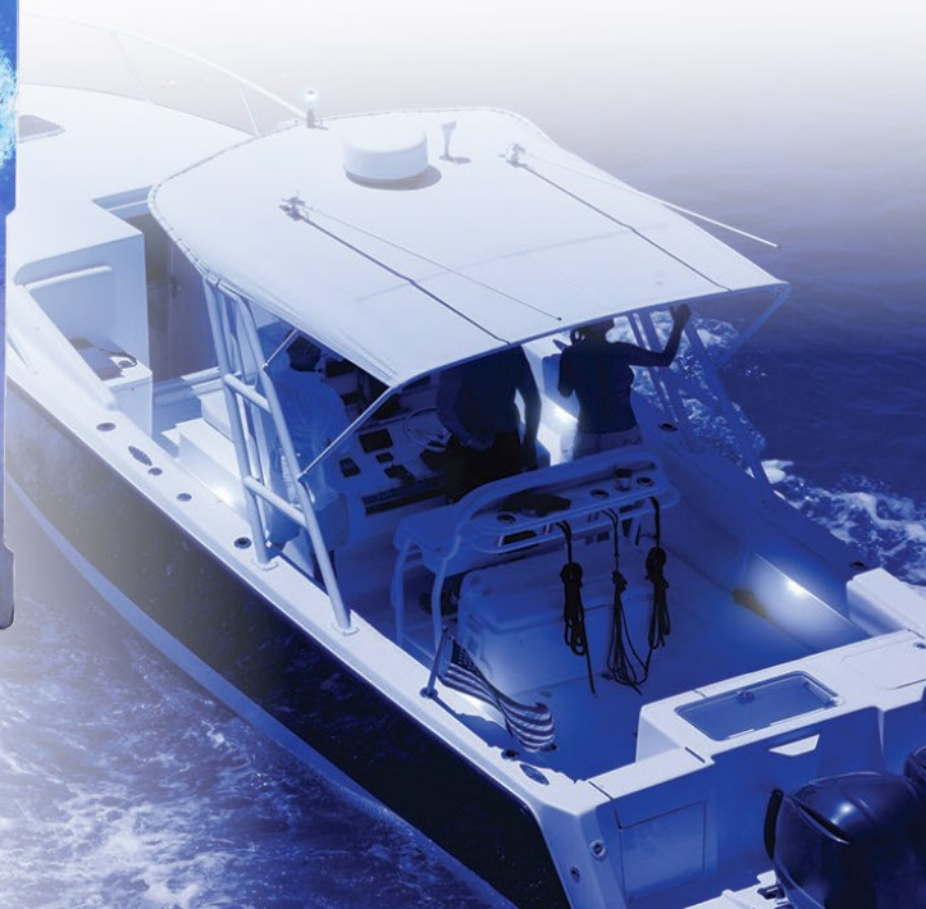

MARINE ACCENT LIGHTING

HE-ML1

1.5x3 INCH

3 LED

★ IP68 ★
CERTIFIED

- White LED: (3) 5-watt LEDs / Wattage: 15W / Raw Lumens: 1200lm
- Blue LED: (3) 3-watt LEDs / Wattage: 9W / Raw Lumens: 720lm
- Beam Pattern: 120° Flood
- Mounting: Surface - 2 rubber bases included

Pod sold individually

HE-ML1B

BLUE



WHITE LED

RGB PRODUCTS MARINE RGB ACCENT LIGHTING

HE-8MLRGBK

8 RGB
PODS

3 LED

★ IP68 ★
CERTIFIED



RGB LEDS

- (3) 3-watt LEDs per pod
- Raw Lumens: 720lm
- HE-CBRGB controller included
- 10' of cable on each pod

The HE-8MLRGBK is a complete kit to light up your boat. (8) HE-MLIRGB RGB accent lights and the HE-CBRGB control box will give you accent lighting where you want it.



**HEISE CONNECT
FREE APP**

MARINE RGB ACCENT LIGHTING

HE-ML1RGB

1 RGB
POD

3 LED

**★ IP68 ★
CERTIFIED**



- Sold as a single light
- (3) 3-watt LEDs
- Raw Lumens: 720lm
- Beam Pattern: 120° Flood
- Works with HE-RGB-CB (sold separately)

Pod sold individually

Includes gasket and cut out template



HE-ML1RGB accent lights and the HE-RGB-CB control box will give you accent lighting where you want it.

ADDITIONAL ACCESSORIES



ACCENT LIGHTING COVER



HE-ML1DIV

RGB CONTROL BOX



HE-RGB-CB

The light cover is for use with HE-TL1(xxx) and HE-ML1(xxx) rock lights.

ML-FMRGB

1 RGB
POD

3 LED

NEW!

**★ IP68 ★
CERTIFIED**



- (3) 3-watt LEDs
- Raw Lumens: 720lm
- Beam Pattern: 120° Flood
- Works with HE-RGB-CB (sold separately)

Pod sold individually

Includes gasket and cut out template



ML-FMRGB accent lights and the HE-RGB-CB control box will give you accent lighting where you want it.

COMMON FEATURES

INPUT VOLTAGE: 10-30V DC

HOUSING MATERIAL: DIE-CAST ALUMINUM

COLOR: WHITE

LENS MATERIAL: POLYCARBONATE

HARDWARE: STAINLESS 316

OPERATING TEMPERATURE: -40°F TO +140°F

PROTECTION: REVERSE POLARITY

CURRENT CONSUMPTION @ 13.8 VOLTS: 0.2A

CABLE LENGTH: 10'



**HEISE CONNECT
FREE APP**

for smartphones
and tablets



MARINE DUAL ROW LED LIGHTBARS

CURVED

HE-MDRC30

30 INCH

60 LED

★ IP67 ★
CERTIFIED



Wattage: 180W • Raw Lumens: 14400lm • Lux @ 10m: 625 lx
Current Consumption @ 13.8V: 9.5A

HE-MDRC42

42 INCH

80 LED

★ IP67 ★
CERTIFIED



Wattage: 240W • Raw Lumens: 19200lm • Lux @ 10m: 780 lx
Current Consumption @ 13.8V: 12A

COMMON FEATURES

INPUT VOLTAGE: 10-30V DC

COLOR TEMPERATURE: 6000K

BEAM PATTERN: COMBO: 90° FLOOD / 8° SPOT

HOUSING MATERIAL: DIE-CAST ALUMINUM

COLOR: WHITE COATING WITH UV

MEMBRANE: PROTECTIVE VENT PORT

LENS MATERIAL: POLYCARBONATE

MOUNTING BOLT DRILL: 0.25"

ELECTRONICS: INTEGRATED EPOXY-ENCAPSULATED

HARDWARE: STAINLESS 316

OPERATING TEMPERATURE: -40°F TO +140°F

PROTECTION: REVERSE POLARITY

MEASUREMENTS

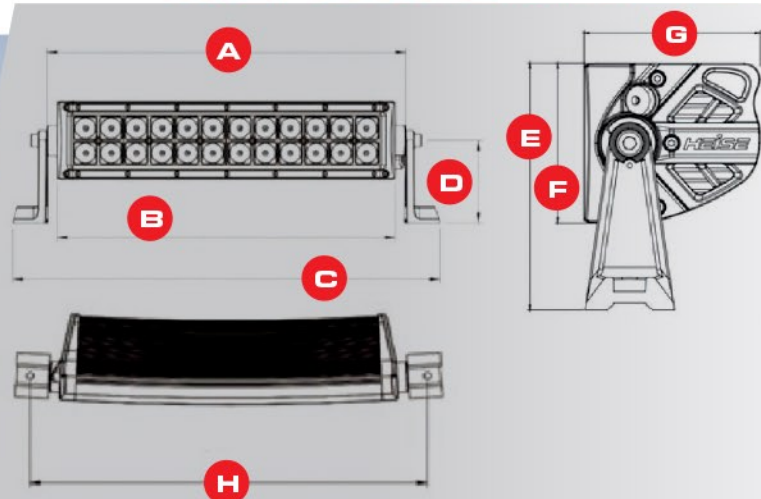

PART	A	B	C	D	E	F	G	H
HE-MDRC30	32.22"	31.44"	34.88"	3.23"	4.80"	3.09"	4.39"	33.56"
HE-MDRC42	42.09"	41.34"	41.34"	3.23"	4.80"	3.09"	5.14"	43.39"





EXTERIOR LIGHTBARS & BEACON

HE-MU47-SLM

AMBER SLIM LIGHT BAR

47.25 INCH

88 LED

- Voltage:** 12-24V DC • **LED Color:** White & Amber
Patterns: 25 Selectable Patterns • **IP Rating:** IP65
Construction: Aluminum Housing, Poly Lenses
- Wired controller with take down, alley, traffic advisor, marker switches and pattern indicator
 - Amber primary lighting, white alley and take down lights



47.25"W x 12"H x 14"D

HE-MU5-BCON

AMBER LIGHT BEACON

3.5 INCH

48 LED

- Voltage:** 12-24V DC • **LED Color:** Amber • **Patterns:** Strobe & Rotator Flash Patterns
IP Rating: IP65 • **Construction:** Poly Housing
- Power outlet adapter with on/off/pattern control switch
 - Magnetic mount or screw down option



3.5"W x 4.6"H

HE-MU13-MINI

AMBER MINI LIGHT BAR

12.9 INCH

36 LED

- Voltage:** 12-24V DC • **LED Color:** Amber • **Patterns:** 15 Self-Controlled with Memory
IP Rating: IP65 • **Construction:** Poly Housing
- Power outlet adapter with on/off switch and pattern control switch
 - Magnetic mount



CUBE LED LIGHTS

HE-CL22PK

3 INCH

4 LED

2 PACK

IP68
CERTIFIED

Wattage: 12W • **Raw Lumens:** 960lm • **Lux @ 10m:** 17 lx
Beam Pattern: 90° Flood • **Current Consumption @ 13.8V:** 0.9A
Color Temperature: 6000K

Heise HE-DLWH1 dual light wiring harness included

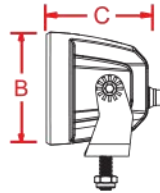

B: 3.42" C: 3.22"



HE-CL3SA

3 INCH

6 LED

IP68
CERTIFIED

Wattage: 18W • **Raw Lumens:** 1440lm • **Lux @ 10m:** 104 lx
Beam Pattern: 5° Spot • **Current Consumption @ 13.8V:** 1.2A
Color Temperature: 3500K

• Amber color for dusty/rainy conditions

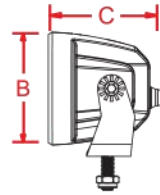

B: 3.42" C: 3.22"



HE-CLA

CUBE

PROTECTIVE LENS COVER

AMBER

- Polycarbonate protective lens
 - Use with HE-CL22PK, HE-ICL2, and HE-ICL22PK
- NOTE: Not for use with the high output cubes



COMMON FEATURES

INPUT VOLTAGE: 10-30V DC

HOUSING MATERIAL: DIE-CAST ALUMINUM

COLOR: BLACK

LENS MATERIAL: POLYCARBONATE

MOUNTING BRACKET: STAINLESS STEEL

ELECTRONICS: INTEGRATED EPOXY-ENCAPSULATED

HARDWARE: STAINLESS 316

OPERATING TEMPERATURE: -40°F TO +140°F

PROTECTION: REVERSE POLARITY

IP RATING: IP68

WORK LED LIGHTS

HE-WL1

3.625x2 INCH

33 LED **★ IP68 ★
CERTIFIED**

Wattage: 60W • Raw Lumens: 726lm
Current Consumption @ 13.8V: 0.3A • Beam Pattern: 120° Flood
Lens Design: Unique Waffle



3.75"W x 3"H x .75"D

HE-WL2

3.625x1.75 INCH

2 LED **★ IP68 ★
CERTIFIED**

Wattage: 10W • Raw Lumens: 800lm
Current Consumption @ 13.8V: 0.4A • Beam Pattern: 90° Flood



3.50"W x 2.50"H x 2.50"D

COMMON FEATURES

INPUT VOLTAGE: 10-30V DC

COLOR TEMPERATURE: 6000K

HOUSING MATERIAL: DIE-CAST ALUMINUM

COLOR: BLACK

LENS MATERIAL: POLYCARBONATE

MOUNTING BRACKET: DIE-CAST ALUMINUM

HOLE DIMENSIONS: MOUNTING BOLT DRILL - .25"

ELECTRONICS: INTEGRATED-EPOXY ENCAPSULATED

HARDWARE: STAINLESS 316

PROTECTION: REVERSE POLARITY

IP RATING: IP68

STROBE KITS

HE-MUSTR-W

LED STROBE KIT

4 PIECE

8 LED

★ IP65 ★
CERTIFIED

Voltage: 12-24V DC • **LED Color:** White

Patterns: 15 Self-controlled with Memory

- Wired controller with on/off switch and pattern control switch



HE-MUSTR-S1W

ADD-ON LED STROBE BULB

8 LED

- LED replacement bulb
- LED Color: White
- Sold individually
- For use with HE-MUSTR-W (sold separately)



HE-MUSTR-GRW

WHITE GRILLE STROBE KIT

4 PIECE

8 LED

★ IP65 ★
CERTIFIED

Voltage: 12V DC • **LED Color:** White

Patterns: 15 Self-controlled with Memory

- Wired controller with on/off switch and pattern control switch



HE-MUSTR-G2W

ADD-ON WHITE GRILLE STROBE SET

2 PIECE

- 2 pieces
- LED Color: White
- Hardware and harness included
- For use with HE-MUSTR-GR(x) (sold separately)



HE-MUSTR-GRA

AMBER GRILLE STROBE KIT

4 PIECE

8 LED

★ IP65 ★
CERTIFIED

Voltage: 12V DC • **LED Color:** Amber

Patterns: 15 Self-controlled with Memory

- Wired controller with on/off switch and pattern control switch



HE-MUSTR-G2A

ADD-ON AMBER GRILLE STROBE SET

2 PIECE

- 2 pieces
- LED Color: Amber
- Hardware and harness included
- For use with HE-MUSTR-GR(x) (sold separately)



SINGLE COLOR MARKER LIGHTS

HE-MUMRK-4W

WHITE MARKER

3.8 INCH

4 LED

*** IP67 *
CERTIFIED**

Voltage: 12-24V DC • **LED Count:** (4) 3W
Patterns: 19 Self-controlled with Memory
Construction: Aluminum Housing Poly Lens

- Sync multiple units of the same model

Light sold individually



3.8"W x 1.1"H x 0.64"D

HE-MUMRK-6W

WHITE MARKER

4.9 INCH

6 LED

*** IP67 *
CERTIFIED**

HE-MUMRK-6A

AMBER MARKER

Voltage: 12-24V DC • **LED Count:** (6) 3W
Patterns: 19 Self-controlled with Memory
Construction: Aluminum Housing Poly Lens

- Sync multiple units of the same model

Light sold individually



4.9"W x 1.1"H x 0.64"D

HE-MULTE-6W

WHITE LITE MARKER

4.4 INCH

6 LED

*** IP67 *
CERTIFIED**

HE-MULTE-6A

AMBER LITE MARKER

HE-MULTE-6B

BLUE LITE MARKER

HE-MULTE-6R

RED LITE MARKER

Voltage: 12-24V DC • **LED Count:** (6) 1W
Patterns: 19 Self-controlled with Memory
Construction: Aluminum Housing Poly Lens

- Sync multiple units of the same model

Light sold individually



4.4"W x 1.1"H x 0.4"D

BI-COLOR MARKER LIGHTS

HE-MUMRK-6WA	1/2 WHITE	1/2 AMBER	4.9 INCH	6 LED	★ IP67 ★ CERTIFIED
HE-MUMRK-6BR	1/2 BLUE	1/2 RED			★ IP67 ★ CERTIFIED

LED Count: (6) 1W
Voltage: 12-24V DC
Patterns: 19 Self-controlled with Memory
Construction: Aluminum Housing Poly Lens

- Sync multiple units of the same model

Light sold individually



4.9"W x 1.1"H x 0.64"D

HE-MULTE-6WA	1/2 WHITE	1/2 AMBER	4.4 INCH	6 LED	★ IP67 ★ CERTIFIED
HE-MULTE-6BR	1/2 BLUE	1/2 RED			★ IP67 ★ CERTIFIED

LED Count: (6) 1W
Voltage: 12-24V DC
Patterns: 19 Self-controlled with Memory
Construction: Aluminum Housing Poly Lens

- Sync multiple units of the same model

Light sold individually



4.4"W x 1.1"H x 0.4"D

HE-MUGRL-6WA	1/2 WHITE	1/2 AMBER	4.1 INCH	6 LED	★ IP65 ★ CERTIFIED
HE-MUGRL-6BR	1/2 BLUE	1/2 RED			★ IP65 ★ CERTIFIED

LED Count: (6) 1W
Voltage: 12-24V DC
Patterns: 16 Self-controlled with Memory
Construction: Aluminum Housing Poly Lens

- Sync multiple units of the same model

Light sold individually



4.1"W x 2.2"H x 0.9"D



TEAM SHOP

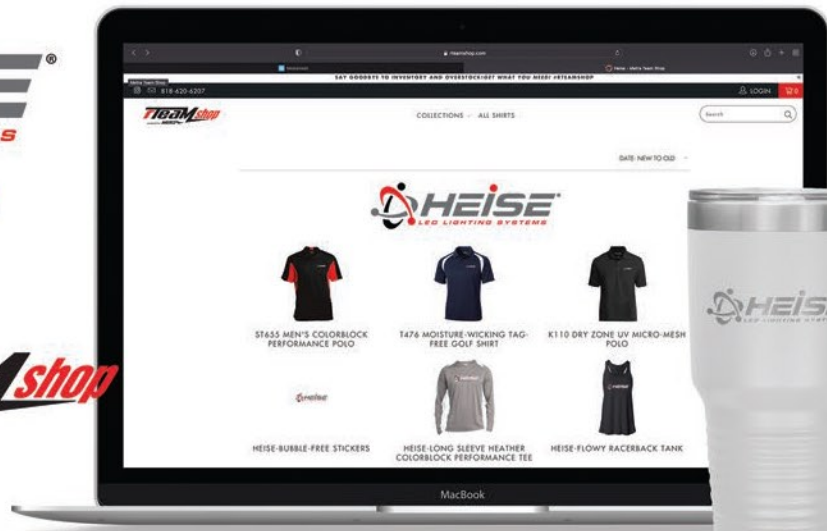

MERCHANDISE

YOUR NEW PROMOTION AGENT

THERE ARE A VARIETY OF OPTIONS FOR DEALERS OF OUR PRODUCTS TO MARKET MERCHANDISE FROM HEISE. WE OFFER TIERED TEAM SHOP PACKAGES TO FIT DEALERS' INDIVIDUAL NEEDS WITH ARTWORK, LOGO RENDERING, AND PRODUCT DESIGNS INCLUDED. THIS IS A COST-EFFECTIVE WAY TO CONTRIBUTE TO THE MARKETING OF OUR DEALERS' BUSINESSES. THERE IS NO VOLUME REQUIREMENT ON ORDERS, SO THEY CAN INVENTORY MERCHANDISE WITHOUT INVESTING A LARGE AMOUNT AT ONCE. MERCHANDISE FROM THE TEAM SHOP CAN BUILD CUSTOMER LOYALTY VIA GIFT CARDS AND PROMOTIONS, MOTIVATE EMPLOYEES WITH NEW UNIFORMS OR OTHER REWARDS, AND SERVES AS EXCELLENT ADVERTISING WITH CUSTOMIZABLE DESIGNS!





TABLE TOP DISPLAYS

HE-DISP-MTBL2 MARINE LIGHTBAR DISPLAYS

- High-quality printed graphics
- Lightweight, rigid material
- Dimensions: 27.5"H x 18"W x 6"D
- Power supply and wiring included

PARTS:

- ML-RGB15W
- ML-DLGRN9W
- ML-BLU27W
- ML-CLBLU
- ML-RGBW24W
- ML-BLU30W
- RGBW-CB1



HE-DISP-TBL1 HE-DISP-TBL2 HE-DISP-TBL3 HE-MUNTTD-1 MPS-TTD-1

- High-quality printed graphics
- Lightweight, rigid material
- Dimensions: 27.5"H x 18"W x 6"D
- Power supply and wiring included



HE-DISP-TBL1

PARTS:

- HE-BCS2PK
- HE-BCS32PK
- HE-BD14



HE-DISP-TBL3

PARTS:

- RGBW1-4KT
- RGB1-4KT
- RGBW-CB2
- HE-5MRGB-1
- HE-PTRGB



HE-DISP-TBL2

PARTS:

- HE-TL1RGB HE-ARB1
- HE-ML1RGB HE-CBRGB
- HE-TL1DIV HE-5MRGB-1
- HE-ML1DIV HE-JWBFL02RGB



HE-MUNTTD-1

PARTS:

- HE-MUMRK-6WA HE-MUMRK-6R
- HE-MUMRK-4B HE-MUMRK-4A
- HE-MULTE-6BA HE-MULTE-6BR
- HE-MUHSR-A HE-MULTE-4W



MPS-TTD-1

PARTS:

- MPS-RGBWWK
- MPS-RGBDL
- MPS-YRGB
- MPS-ECR072

MERCHANDISE & DISPLAYS

A-FRAME DISPLAY

- Dimensions: 76"H x 40"W x 27"D
- High-quality print
- Includes Heise graphics



JP-AFM2

PARTS:

- | | |
|--------------|----------|
| JP-1014 x .5 | JP-SML1 |
| 107-CH3B | JP-SML2 |
| JP-1015 x .5 | JP-TL03T |
| JP-702B x .5 | JP-TL04T |
| JP-704B x .5 | JP-TSL1 |
| JP-704RGB | JP-TTL2 |
| JP-704RGBFL | RGB-CB1K |

BC-AFM2

PARTS:

- | | |
|----------------|-------------|
| BC-451B | BC-LPBST |
| BC-701B | BC-MHBSBB |
| BC-BFKC | BC-PC1157AW |
| BC-HBTS | BC-SBMKL |
| BC-HD69PR x .5 | BC-ST51 |
| BC-HDLFP x .5 | BC-ST53 |
| BC-HDTL9 | BC-WST5B14 |

HE-AFRAMEDISP

- Blank display
- build your own
- Includes Heise graphics



DL-AFM2

PARTS:

- DL-CL2
- DL-CL3
- DL-DL1
- DL-DL4R
- DL-DL4S
- DL-DR32
- DL-H11
- DL-RGBK1
- DL-US135



HE-AFM5

PARTS:

- HE-B950
- HE-BCF2PK (.5)
- HE-BD14
- HE-DGBK6
- HE-EL2
- HE-FMBCS
- HE-FMBL1
- HE-FMICL2
- HE-INFIN8
- HE-TSL20
- HE-WLAF
- RGB1-4KT
- RGBW1-4KT
- RGBW-CB1

* Products listed may change based on availability

HE-DISP-HL

HEADLIGHT DISPLAY

- High-quality printed graphics
- (1) 9007 LED dual beam bulb
- 110V/3a wall plug



HE-LEDDISPLAY

LED STRIP DISPLAY

- High-quality printed graphics
- Lightweight, rigid material
- Color LEDs mounted for light sampling
- Dimensions: 12"H x 9.5"W



HE-DISP-PRO

LED BULB DISPLAY

- High-quality printed graphics
- Lightweight, rigid material
- Dual-beam HE-9007PRO mounted for light sampling
- Dimensions: 12"H x 9.5"W
- Wall plug



HE-DISP-HID

LED BULB DISPLAY

- High-quality printed graphics
- Lightweight, rigid material
- Color LEDs mounted for light sampling
- Dimensions: 12"H x 9.5"W
- Wall plug



MERCHANDISE & DISPLAYS

SKINNY DISPLAY

RACK700

- Dimensions: 72"H x 20"W x 13.5"D
- Black powder-coated metal display
- Metal pegboard for high strength
- Display stand only



XL DISPLAY

RACK750

- Dimensions: 78"H x 39.5"W x 13.5"D
- Large black-powder coated metal display
- Metal pegboard for high strength
- Display stand only



HEISE DECALS

HE-700TOP HE-700BOT

- Heise small top magnetic decal HE-700TOP
- Heise small bottom magnetic decal HE-700BOT



HEISE DECALS

HE-LARGETOP

- Heise large top magnetic decal



MERCHANDISE & DISPLAYS

HEISE T-SHIRT & HAT

HE-TSHIRTL LARGE

HE-TSHIRTXL X-LARGE

HE-TSHIRTXXL XX-LARGE

- Black shirt with white & red screenprint on front & back



HEISE-SLATHDR SLATWALL HEADER

- High-quality printed logo graphic
- Lightweight, rigid material
- Dimensions: 48"H x 8"W



HE-BANNER HEISE BANNER

- High-quality printed banner
- Includes reinforced holes for hanging
- Dimensions: 48"H x 24"W



HE-DISPSTKR

TORTURE SHELF TALKER

- Call to action by your display
- Dimensions: 2.5"H x 1.5"W



HE-STICKER

HEISE STICKERS

- 1.5"H X 5.75"W silver diecut vinyl



TERMS & CONDITIONS

TERMS

Net 30 days from date of invoice on approved accounts. Minimum order: \$50 per invoice, orders less than required minimum incur a \$20 service charge.

FREIGHT

Freight on board (F.O.B.) from point of shipment. Freight will be charged on all drop-shipment orders.

CREDIT

In order to establish a credit line with Metra, an application for credit must be submitted listing a minimum of five (5) trade references and a bank with their addresses and phone numbers and must be signed by a principal or authorized officer of the company. A credit line will be established by our credit manager and must be maintained in a current status according to our terms (net 30 days). Credit not established or revoked requires remittance with order. Returned checks are subject to a fee of \$32.00.

RESALE TAX EXEMPTION CERTIFICATE

CA, TX, KY, NJ & FL customers must provide a valid resale card before an order can be placed.

CLAIMS

Title and risk of loss passes to buyer at F.O.B. shipping point and all claims must be filed with carrier. Any discrepancies must be reported to Metra within ten (10) days of receipt of shipment.

RETURNS

All sales are final. No returns or exchanges will be allowed without prior written authorization from Metra. All returns are subject to a 20% handling charge, must be in a salable condition and must have been purchased within sixty (60) days of return request. No stock balancing permitted. Copies of invoices must be mailed in advance for any return authorization (R.A.).

WARRANTY

This limited warranty is provided by Metra Electronics Corporation and there are no other warranties, expressed or implied, except as required by law, including warranties of merchantability and fitness for a specific purpose, that are provided for herein, however all such implied warranties, if any, are limited to the duration of this specific limited product warranty. Some states do not allow limitations on how long an implied warranty lasts, so the above limitations may not apply to you.

Metra Electronics Corporation shall not be liable, under any circumstances, for incidental, indirect, special, consequential or multiple damages as a result of the sale or use of this product. Some states/countries do not allow the exclusion or limitation of incidental or consequential damages, so the above limitation or exclusion may not apply to you.

Lifetime Limited Warranty Products Covered:

Lightbars and Cube Style LED Lights.

Warranty Period:

Lifetime warranty for manufacturing defects. Rust and corrosion are NOT covered. Damaged, modified or cut harnesses VOID this warranty. Mounting brackets are NOT covered under this warranty. Mounting brackets are covered for 1 year from the date of original retail purchase.

3-Year Limited Warranty Products Covered:

LED Bulbs, Sealed Headlights, Accent Lights, Taillights and Fog Lights.

Warranty Period:

Warranted for 3 years from the date of original retail purchase for manufacturer defects. Rust and corrosion are NOT covered. Damaged, modified or cut harnesses VOID this warranty. Mounting brackets are NOT covered under this warranty. Mounting brackets are covered for 1 year from the date of original retail purchase.

1-Year Limited Warranty Products Covered:

Municipality Lighting, LED Strips, RGB Controllers, LED Controllers, Switch Controllers, Underglow Kits, Wheel Lights, Accent Eagle Eye Lights, and Mounting Brackets

Warranty Period:

Warranted for 1 year from the date of original retail purchase for manufacturing defects. Rust and corrosion are NOT covered. Damaged, modified or cut harnesses VOID this warranty

BACK ORDERS

If an item is temporarily unavailable for immediate shipment, we will backorder the item & ship as soon as possible from the nearest available warehouse, unless otherwise instructed. Metra reserves the right to make changes in or deletions of products or prices without prior notice.

*Metra will not assume any responsibility for damages to person or property due to incorrect interpretation of the material in this publication. Metra is not responsible for typographical or printing errors. Reproductions of editorial or pictorial content is strictly prohibited without prior consent from Metra.



AT YOUR FINGERTIPS

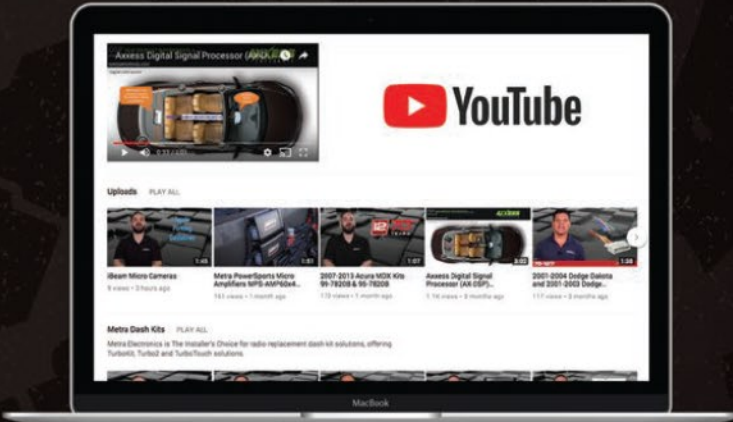

Follow Us!

- **FEATURED INSTALLS**
- **Q & A**



- **NEW PRODUCTS**
- **INSTRUCTION VIDEOS**



www.instagram.com /HeiseLED

SHARE YOUR PROJECT PHOTOS WITH US FOR A CHANCE TO BE FEATURED ON OUR SOCIAL MEDIA. TAG @HEISELED AND @METRAELECTRONICS IN YOUR POSTS!



CHECK OUT OUR

TORTURE TESTS TODAY! HEISELED.COM



2022-2023

DOWNLOAD CATALOGS

WARNING: This catalog does not advise whether a State of California Proposition 65 warning is required for a particular item of merchandise. To learn whether a particular item of merchandise requires a California Proposition 65 warning, please be sure to look up and read the particular merchandise's listing on Metra's website www.HeiseLED.com, as well as read the particular merchandise's packaging. When a California Proposition 65 warning is present on Metra's website listing for the particular merchandise, or on the particular merchandise's packaging, a compliant California Proposition 65 warning is to be provided to the purchasing California consumer prior to the sale of the particular merchandise.



US OPERATIONS

METRA ELECTRONICS CORPORATION
460 WALKER STREET
HOLLY HILL, FL 32117-2699

METRA CORPORATE: 386.257.1186
METRA 12VOLT & INTERNATIONAL SALES: 386.257.2956
SALES FAX: 386.258.3940

HEISE-CAT23



© COPYRIGHT 2023 - METRA ELECTRONICS CORPORATION



[www.facebook.com/
HeiseLED](http://www.facebook.com/HeiseLED)



[www.twitter.com/
MetraElectronic](http://www.twitter.com/MetraElectronic)



[www.youtube.com/
user/MetraElectronics](http://www.youtube.com/user/MetraElectronics)



[www.instagram.com/
HeiseLED](http://www.instagram.com/HeiseLED)



Order Anytime Day or Night
at www.MetraDealer.com



Download Catalogs at
www.MetraOnline.com