

# DWM-313

## 4G LTE M2M Router

### User Manual



# 4G LTE M2M Router

Chapter 1 Introduction.....	6
1.1 Introduction .....	6
1.2 Contents List .....	7
1.2.1 Package Contents.....	7
1.3 Hardware Configuration.....	8
1.4 LED Indication.....	9
1.5 Installation & Maintenance Notice.....	10
1.5.1 SYSTEM REQUIREMENTS .....	10
1.5.2 WARNING.....	10
1.5.3 HOT SURFACE CAUTION .....	11
1.6 Hardware Installation.....	13
1.6.1 Mount the Unit .....	13
1.6.2 Insert the SIM Card .....	13
1.6.3 Install the External Antenna .....	14
1.6.4 Connecting Serial Devices.....	15
1.6.5 Connecting Power .....	16
1.6.6 Connecting to the Network or a Host.....	16
1.6.7 Setup by Configuring WEB UI .....	17
Chapter 2 Basic Network.....	18
2.1 WAN & Uplink.....	18
2.1.1 Physical Interface .....	19
2.1.2 Internet Setup.....	24
2.2 LAN & VLAN .....	48
2.2.1 Ethernet LAN .....	48
2.2.2 VLAN .....	51
2.2.3 DHCP Server .....	64
2.3 WiFi.....	72
2.3.1 WiFi Configuration.....	73
2.3.2 Wireless Client List .....	86

# 4G LTE M2M Router

2.3.3 Advanced Configuration .....	88
2.3.4 Uplink Profile .....	90
2.4 IPv6 .....	94
2.4.1 IPv6 Configuration .....	94
2.5 Port Forwarding.....	102
2.5.1 Configuration.....	103
2.5.2 Virtual Server & Virtual Computer.....	104
2.5.3 DMZ & Pass Through .....	110
2.6 Routing.....	113
2.6.1 Static Routing .....	114
2.6.2 Dynamic Routing .....	117
2.6.3 Routing Information .....	122
2.7 DNS & DDNS.....	123
2.7.1 DNS & DDNS Configuration .....	123
Chapter 3 Object Definition.....	127
3.1 Scheduling.....	127
3.1.1 Scheduling Configuration.....	127
3.2 User (not supported) .....	129
3.3 Grouping (not supported) .....	130
3.4 External Server .....	131
3.5 Certificate .....	134
3.5.1 Configuration (not supported).....	134
3.5.2 My Certificate.....	135
3.5.3 Trusted Certificate .....	142
Chapter 4 Field Communication .....	149
4.1 Bus & Protocol .....	149
4.1.1 Port Configuration .....	149
4.1.2 Virtual COM.....	151
Chapter 5 Security .....	161
5.1 VPN .....	161
5.1.1 IPsec.....	162

# 4G LTE M2M Router

5.1.2 OpenVPN .....	169
5.1.3 L2TP.....	176
5.1.4 PPTP .....	181
5.1.5 GRE .....	185
5.2 Firewall .....	189
5.2.1 Packet Filter .....	189
5.2.2 URL Blocking.....	194
5.2.3 MAC Control .....	197
5.2.4 Content Filter (not supported).....	200
5.2.5 Application Filter (not supported).....	201
5.2.6 IPS .....	202
5.2.7 Options .....	206
Chapter 6 Administration .....	210
6.1 Configure & Manage .....	210
6.1.1 Command Script.....	211
6.1.2 D-ECS(D-LINK EDGE CLOUD SOLUTION) .....	215
6.1.3 SNMP.....	217
6.1.4 Telnet & SSH .....	228
6.2 System Operation.....	231
6.2.1 Password & MMI.....	231
6.2.2 System Information .....	235
6.2.3 System Time .....	236
6.2.4 System Log.....	241
6.2.5 Backup & Restore .....	246
6.2.6 Reboot & Reset.....	248
6.3 FTP (not supported) .....	249
6.4 Diagnostic .....	250
6.4.1 Diagnostic Tools.....	250
6.4.2 Packet Analyzer .....	251
Chapter 7 Service .....	254
7.1 Cellular Toolkit.....	254

# 4G LTE M2M Router

7.1.1 Data Usage.....	255
7.1.2 SMS .....	258
7.1.3 SIM PIN.....	262
7.1.4 USSD .....	266
7.1.5 Network Scan.....	269
7.2 SMS & Event .....	271
7.2.1 Configuration.....	272
7.2.2 Managing Events.....	276
7.2.3 Notifying Events.....	279
Chapter 8 Status .....	281
8.1 Dashboard.....	281
8.1.1 Device Dashboard .....	281
8.2 Basic Network.....	283
8.2.1 WAN & Uplink Status .....	283
8.2.2 LAN & VLAN Status.....	287
8.2.3 WiFi Status .....	288
8.2.4 DDNS Status.....	291
8.3 Security .....	292
8.3.1 VPN Status.....	292
8.3.2 Firewall Status.....	295
8.4 Administration.....	299
8.4.1 Configure & Manage Status.....	299
8.4.2 Log Storage Status .....	300
8.5 Statistics & Report.....	301
8.5.1 Connection Session.....	301
8.5.2 Network Traffic (not supported) .....	302
8.5.3 Login Statistics.....	303
8.5.4 Cellular Usage.....	304

# 4G LTE M2M Router

## Chapter 1 Introduction

### 1.1 Introduction

Congratulations on your purchase of this outstanding product: 4G M2M Router. For M2M (Machine-to-Machine) applications, D-Link 4G M2M Router is absolutely the right choice. With built-in world-class 3G/4G module, you just need to insert SIM card from local mobile carrier to get to Internet. By VPN tunneling technology, remote sites easily become a part of Intranet, and all data are transmitted in a secure (256-bit AES encryption) link.

Main Features:

- **Compact design:** Built-in LTE and configurable Ethernet WAN/LAN can provide Ethernet machine easy connection to internet/intranet by LTE or high reliable fail-over wired/LTE connection.
- **Dual SIM:** Embedded 3G/4G with configurable dual-SIM achieve location free multi-ISP fail-over requirement.
- **Versatile Cellular:** Preferred service selection can simplify uplink setting; toolkit function of data usage can control budget; configurable SMS command is useful and efficient for remote administration.
- **Complete Network:** Built-in NAT/Port Forward/Routing/IPv6 are compatible to existing IP network.
- **Highly Security:** Various VPN protocol & scenario can setup secure intranet; built-in Firewall prevents malicious attacks; ACL & Authentication by MAC /User enhances secure access.
- **Flexible Administration:** Web UI is used for basic setting; programmable CLI and Command Script are used for advanced configuration; system can be managed by D-ECS (D-Link Edge Cloud Solution).
- **Smart Event Handling:** Mechanism to manage action for pre-defined events by administrator. Events can be triggered or notified based on System/Interface status change, SMS, SNMP trap, or e-mail.

Before you install and use this product, please read this manual in detail for fully exploiting the functions of this product.

# 4G LTE M2M Router

## 1.2 Contents List

### 1.2.1 Package Contents

#### #Standard Package

Items	Description	Contents	Quantity
1	DWM-313 4G M2M Router		1pcs
2	Cellular Antenna		2pcs
3	WiFi Antenna		1pcs
4	Power Adapter (DC 5V/2A) (*1)		1pcs
5	DIN-Rail Bracket		1 set (2pcs)
6	RJ45 Cable		1pcs
7	Terminal Block		1pcs
8	Micro-USB Serial Cable		1pcs
9	Rubber Feet		4pcs

1 The maximum power consumption of DWM-313 series product is 7.0W.

# 4G LTE M2M Router

## 1.3 Hardware Configuration

### ➤ Left View

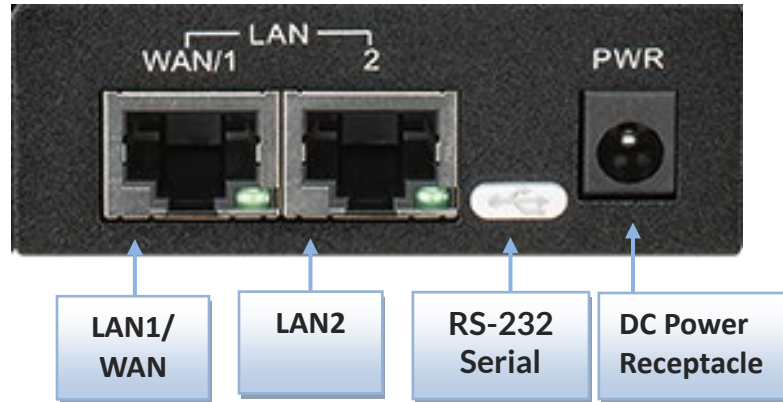

### ➤ Right View

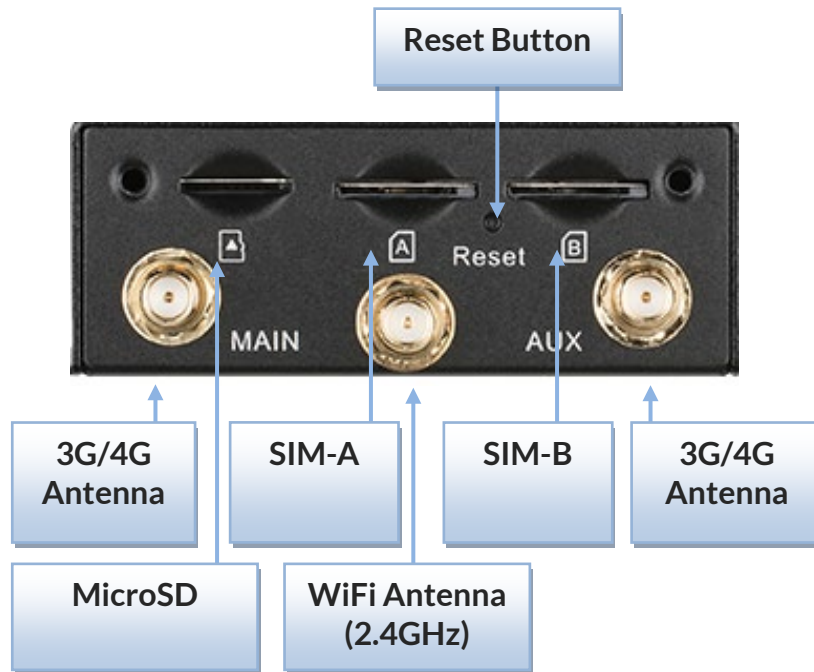

remove security plate before u use SIM card.

### ✘Reset Button

The RESET button provides user with a quick and easy way to resort the default setting. Press the RESET button continuously for 6 seconds, and then release it. The device will restore to factory default settings.

# 4G LTE M2M Router

## 1.4 LED Indication



Indication	LED Color	Description
Signal LTE/3G	Blue Purple Red	When the LED color is shown in: <ul style="list-style-type: none"><li>• <b>Blue:</b> Cellular module is in LTE Mode.</li><li>• <b>Purple:</b> Cellular module is in HSPA/3G Mode.</li><li>• <b>Red:</b> Cellular module is in GSM/2G Mode.</li></ul> When the behavior of LED is: <ul style="list-style-type: none"><li>• <b>Fast Flash (per 0.5 second):</b> Signal Strength is 0~30%</li><li>• <b>Flash (Slow, per second):</b> Signal Strength is 31~60%</li><li>• <b>Steady On:</b> Signal Strength is 61~100%</li></ul>
WiFi	Blue	<b>Off:</b> WiFi Radio is disabled. <b>On:</b> WiFi Radio is enabled. <b>Flash:</b> Data Packet transferred via WiFi.
Network connectivity	Blue	<b>Flash (per second):</b> The gateway works normally. <b>Flash (Fast):</b> The gateway is in Recovery Mode or abnormal situation. <b>Note:</b> If you encountered the abnormal situation, even power OFF / ON the device, there might be something wrong during the device boot up session and it was damaged. You need to call for RMA service to recover it.
LAN/WAN	Green	<b>Off:</b> Host disconnected. <b>On:</b> Ethernet connection established. <b>Flash:</b> Data packet transferred via Ethernet.

# 4G LTE M2M Router

## 1.5 Installation & Maintenance Notice

### 1.5.1 SYSTEM REQUIREMENTS

Network Requirements	<ul style="list-style-type: none"><li>• A fast Ethernet RJ45 cable</li><li>• 3G/4G cellular service subscription</li><li>• IEEE 802.11b/g/n wireless client</li><li>• 10/100 Ethernet adapter on PC</li></ul>
Web-based Configuration Utility Requirements	<p><b>Computer with the following:</b></p> <ul style="list-style-type: none"><li>• Windows®, Macintosh, or Linux-based operating system</li><li>• An installed Ethernet adapter</li></ul> <p><b>Browser Requirements:</b></p> <ul style="list-style-type: none"><li>• Internet Explorer 6.0 or higher</li><li>• Chrome 2.0 or higher</li><li>• Firefox 3.0 or higher</li><li>• Safari 3.0 or higher</li></ul>

### 1.5.2 WARNING



**Attention**

- Only use the power adapter that comes with the package. Using a different voltage rating power adaptor is dangerous and may damage the product.
- Do not open or repair the case yourself. If the product is too hot, turn off the power immediately and have it repaired at a qualified service center.
- Place the product on a stable surface and avoid using this product and all accessories outdoors.

# 4G LTE M2M Router

## 1.5.3 HOT SURFACE CAUTION



**CAUTION:** The surface temperature for the metallic enclosure can be very high! Especially after operating for a long time, installed at a closed cabinet without air conditioning support, or in a high ambient temperature space.

**DO NOT touch the hot surface with your fingers while servicing!!**

# 4G LTE M2M Router

## **Federal Communication Commission Interference Statement**

This device complies with Part 15 of the FCC Rules. Operation is subject to the following two conditions: (1) This device may not cause harmful interference, and (2) this device must accept any interference received, including interference that may cause undesired operation.

This equipment has been tested and found to comply with the limits for a Class B digital device, pursuant to Part 15 of the FCC Rules. These limits are designed to provide reasonable protection against harmful interference in a residential installation. This equipment generates, uses and can radiate radio frequency energy and, if not installed and used in accordance with the instructions, may cause harmful interference to radio communications. However, there is no guarantee that interference will not occur in a particular installation. If this equipment does cause harmful interference to radio or television reception, which can be determined by turning the equipment off and on, the user is encouraged to try to correct the interference by one of the following measures:

- Reorient or relocate the receiving antenna.
- Increase the separation between the equipment and receiver.
- Connect the equipment into an outlet on a circuit different from that to which the receiver is connected.
- Consult the dealer or an experienced radio/TV technician for help.

FCC Caution: Any changes or modifications not expressly approved by the party responsible for compliance could void the user's authority to operate this equipment.

This transmitter must not be co-located or operating in conjunction with any other antenna or transmitter.

## **FOR PORTABLE DEVICE USAGE (<20m from body/SAR needed)**

### **Radiation Exposure Statement:**

The product comply with the FCC portable RF exposure limit set forth for an uncontrolled environment and are safe for intended operation as described in this manual. The further RF exposure reduction can be achieved if the product can be kept as far as possible from the user body or set the device to lower output power if such function is available.

## **FOR MOBILE DEVICE USAGE (>20cm/low power)**

### **Radiation Exposure Statement:**

This equipment complies with FCC radiation exposure limits set forth for an uncontrolled environment. This equipment should be installed and operated with minimum distance 20cm between the radiator & your body.

## **FOR COUNTRY CODE SELECTION USAGE (WLAN DEVICES)**

Note: The country code selection is for non-US model only and is not available to all US model. Per FCC regulation, all WiFi product marketed in US must fixed to US operation channels only.

# 4G LTE M2M Router

## 1.6 Hardware Installation

This chapter describes how to install and configure the hardware

### 1.6.1 Mount the Unit

The DWM-313 series can be placed on a desktop, or mounted on the wall.

### 1.6.2 Insert the SIM Card

**WARNING: BEFORE INSERTING OR CHANGING THE SIM CARD, PLEASE MAKE SURE THAT POWER OF THE DEVICE IS SWITCHED OFF.**

The SIM card slots are located at the right side of DWM-313 series housing in order to protect the SIM card. You need to unscrew and remove the outer SIM card cover before installing or removing the SIM card. Please follow the instructions to insert or eject a SIM card. After SIM card is well placed, screw back the outer SIM card cover.

#### Step 1:

Loosen the screws as below and remove the SIM cover.



#### Step 2:

Push the SIM card into the slot A (SIM-A) or slot B (SIM-B).



#### Step 3:

Push the inserted SIM card again to eject it from the SIM slot.



# 4G LTE M2M Router

## 1.6.3 Install the External Antenna

As illustrated in Section 1.3, there are several SMA antenna Jacks for you to install the required antennas for the RF signal transmission and receiving. You have to purchase required RF cables and antennas separately for a specific project or installation site to get excellent RF performance.

Since there is limited spacing for allocating all SMA antenna Jacks around the enclosure, the separation among SMA Jacks (or direct-attached antennas) could be not the optimized arrangement. It is very likely to get degraded RF performance at specific circumstances. It depends heavily on the environment.

However, there are well-known rules of thumb for solving the antenna separation issue.

- 1: The horizontal distance between antennas should be greater than 1/4 of its wavelength, and there will be best separation at 1/2 of its wavelength.***
- 2. If multiple frequency antennas are near each other, then use spacing distance of the lower frequency antenna, or even better try to satisfy the rule for both frequencies.***

**Wavelength Table for Major RF Category**

<b>RF Category</b>	<b>Frequency</b>	<b>Wavelength</b>	<b>1/2 Wave Length (Best Separation)</b>	<b>1/4 Wave Length (Good Separation)</b>
WiFi 802.11	5.8GHz	5.2cm	2.6cm	1.3cm
WiFi 802.11	2.4GHz	12.5cm	6.2cm	3.1cm
Cellular LTE	2600MHz	11.5cm	5.8cm	2.9cm
Cellular LTE	2100MHz	14.3cm	7.1cm	3.7cm
Cellular LTE	900MHz	33.3cm	16.6cm	8.3cm
Cellular LTE	700MHz	42.8cm	21.4cm	10.7cm
GPS	1.57GHz	19.0cm	9.5cm	4.7cm

For example, if you have a 900MHz LTE antenna and a WiFi 2.4GHz antenna, you would want them to be separated by at least 8.3cm to get good antenna separation.

**So, it is recommended to use some external RF cables to extend and separate the adjacent antennas and get better antenna separation and RF performance, if required.**

# 4G LTE M2M Router

## 1.6.4 Connecting Serial Devices

The DWM-313 provides one Micro-USB type serial port. Connect the serial device to the serial port with the right pin assignments of RS-232 as shown below. There is an optional Micro-USB serial cable for connecting to the serial device.

### Micro-USB Serial Receptacle Pinout

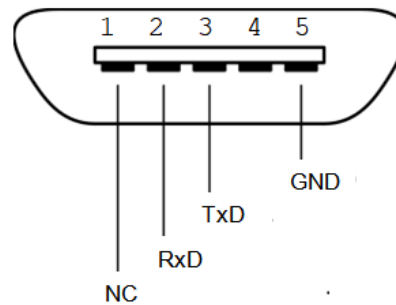
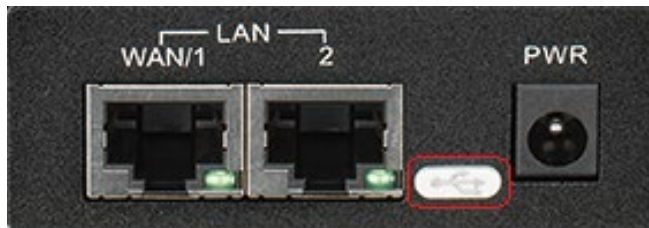

### Pinout Definition

	Pin1	Pin2	Pin3	Pin4	Pin5
RS-232	NC	RxD (I)	TxD (O)	NC	GND
Serial Cable Color code	Red	White	Green		Black

**Note:** Make sure the pinout is compatible to your serial device, or you use a serial conversion cable with proper pinout arrangements.

# 4G LTE M2M Router

## 1.6.5 Connecting Power

There is a DC 5V/2A power adapter<sup>2</sup> in the package for you to easily connect DC power to this gateway.

If you powered the gateway with other DC Power Source, please make sure the DC Power voltage is comply to 5V ~ 18V.



**WARNING: This commercial-grade power adapter is mainly for ease of powering up the purchased device while initial configuration. It's not for operating at wide temperature range environment. PLEASE PREPARE OR PURCHASE OTHER INDUSTRIAL-GRADE POWER SUPPLY FOR POWERING UP THE DEVICE.**

## 1.6.6 Connecting to the Network or a Host

The DWM-313 series product provides two RJ45 ports to connect 10/100Mbps Ethernet. It can auto detect the transmission speed on the network and configure itself automatically. Connect one Ethernet cable to the RJ45 port (LAN) of the device and plug another end of the Ethernet cable into your computer's network port. In this way, you can use the RJ45 Ethernet cable to connect the device to the host PC's Ethernet port for configuring the device.

---

<sup>2</sup> The maximum power consumption of DWM-313 series product is 7.0W.

# 4G LTE M2M Router

## 1.6.7 Setup by Configuring WEB UI

You can browse web UI to configure the device.

Type in the IP Address (<http://192.168.0.1>)<sup>3</sup>

When you see the login page, enter the user name and password and then click 'Login' button. The default setting for both username and password is 'admin'.

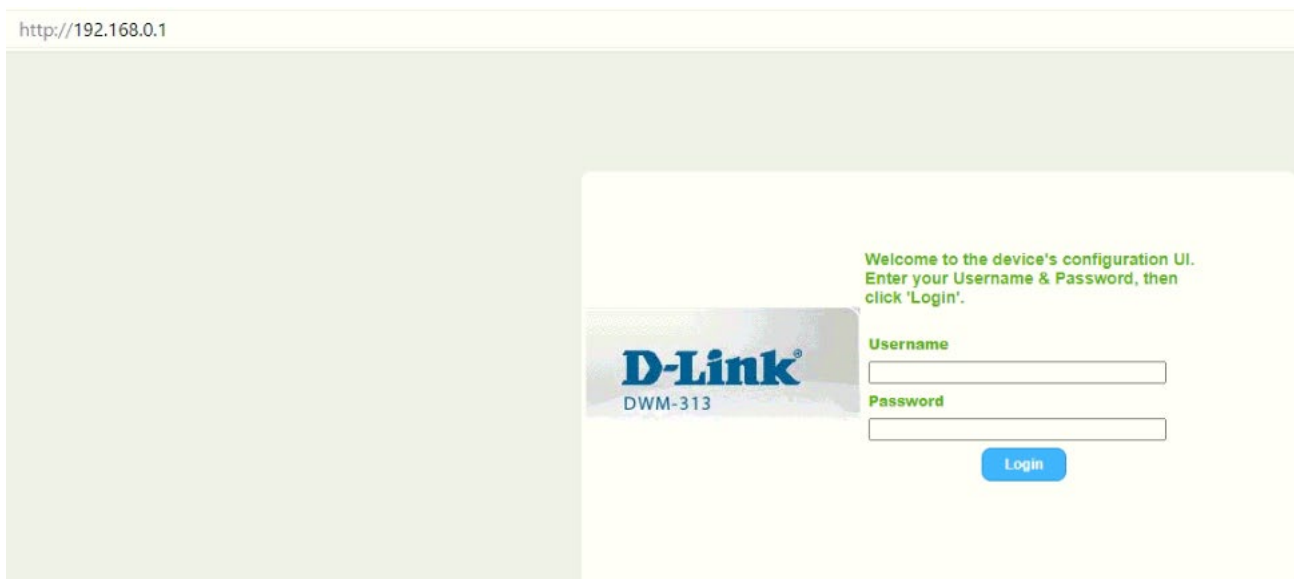

For the security consideration, you will be asked to change the logging password while the first time login to the device.

After that, you will be asked to login again with the new password.

**Note 1:** Keep the login password properly for further device configuration.

**Note 2:** If, someday, you lose or forget the login password, the ONLY way to remedy is to recover the device to its factory default settings via long-pressing the Reset button.

**Note 3:** Under such situation, your device configuration will be erased accordingly. So, In addition to keep the login password, you may have to backup the device donfiguration and keep it properly for any unexpected accident.

---

<sup>3</sup> The default LAN IP address of this gateway is 192.168.0.1. If you change it, you need to login by using the new IP address.

# 4G LTE M2M Router

## Chapter 2 Basic Network

### 2.1 WAN & Uplink

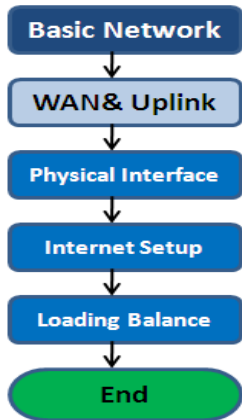

Physical Interface List			
Interface Name	Physical Interface	Operation Mode	Action
WAN-1	Ethernet	Always on	<input type="button" value="Edit"/>
WAN-2	3G/4G	Always on	<input type="button" value="Edit"/>
WAN-3	-	Disable	<input type="button" value="Edit"/>
WAN-4	-	Disable	<input type="button" value="Edit"/>

The gateway provides multiple WAN interfaces to let all client hosts in Intranet of the gateway access the Internet via ISP. But ISPs in the world apply various connection protocols to let gateways or user's devices dial in ISPs and then link to the Internet via different kinds of transmit media.

So, the WAN Connection lets you specify the WAN Physical Interface, WAN Internet Setup and WAN Load Balance for Intranet to access Internet. For each WAN interface, you must specify its physical interface first and then its Internet setup to connect to ISP. Besides, since the gateway has multiple WAN interfaces, you can assign physical interface to participate in the Load Balance function.

# 4G LTE M2M Router

## 2.1.1 Physical Interface

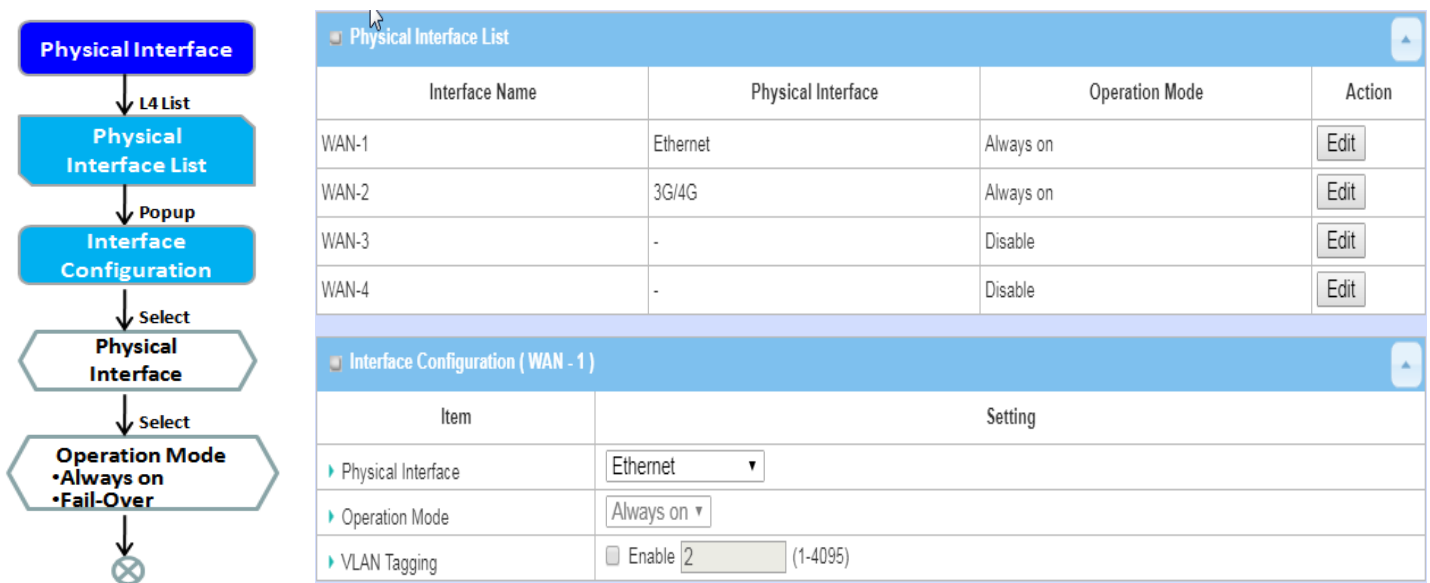

M2M gateways are usually equipped with various WAN interfaces to support different WAN connection scenario for requirement. You can configure the WAN interface one by one to get proper internet connection setup. **Refer to the product specification for the available WAN interfaces in the product you purchased.**

The first step to configure one WAN interface is to specify which kind of connection media to be used for the WAN connection, as shown in "Physical Interface" page.

In "Physical Interface" page, there are two configuration windows, "Physical Interface List" and "Interface Configuration". "Physical Interface List" window shows all the available physical interfaces. After clicking on the "Edit" button for the interface in "Physical Interface List" window the "Interface Configuration" window will appear to let you configure a WAN interface.

### Physical Interface:

- **Ethernet WAN:** The gateway has one or more RJ45 WAN ports that can be configured to be WAN connections. You can directly connect to external DSL modem or setup behind a firewall device.
- **3G/4G WAN:** The gateway has one built-in 3G/4G cellular as WAN connection. For each cellular WAN, there are 1 or 2 SIM cards to be inserted for special failover function.



- Please **MUST POWER OFF** the gateway before you insert or remove SIM card.
- The SIM card can be damaged if you insert or remove SIM card while the gateway is in operation.

# 4G LTE M2M Router

- **WiFi Uplink WAN:** For the product with WiFi Uplink function, one WiFi module can be configured to be WAN connections. For the WiFi module with Uplink function activated, you can further create some uplink profiles for ease of connecting to an uplink network.

## Operation Mode:

There are three option items "Always on", "Failover", and "Disable" for the operation mode setting.

**Always on:** Set this WAN interface to be active all the time. When two or more WAN are established at "Always on" mode, outgoing data will through these WAN connections base on load balance policies.

## Failover:

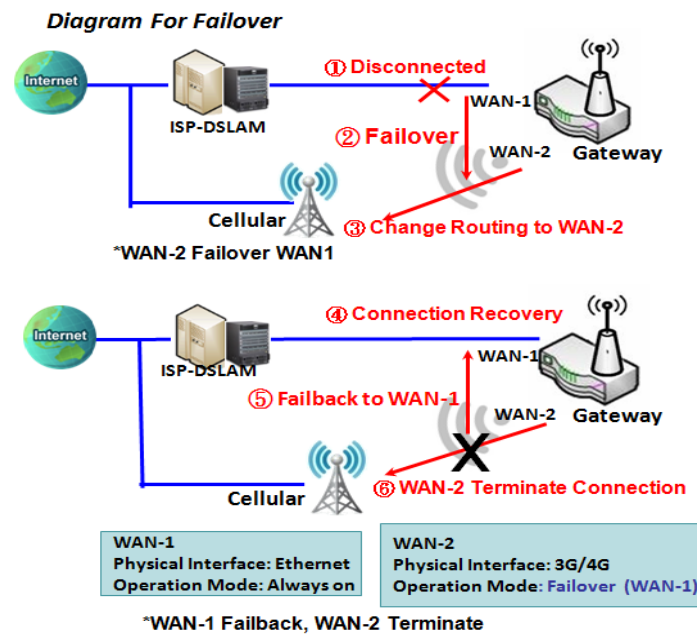

A failover interface is a backup connection to the primary. That means only when its primary WAN connection is broken, the backup connection will be started up to substitute the primary connection. As shown in the diagram, WAN-2 is backup WAN for WAN-1. WAN-1 serves as the primary connection with operation mode "Always on". WAN-2 won't be activated until WAN-1 disconnected. When WAN-1 connection is recovered back with a connection, it will take over data traffic again. At that time, WAN-2 connection will be terminated.

## Seamless Failover:

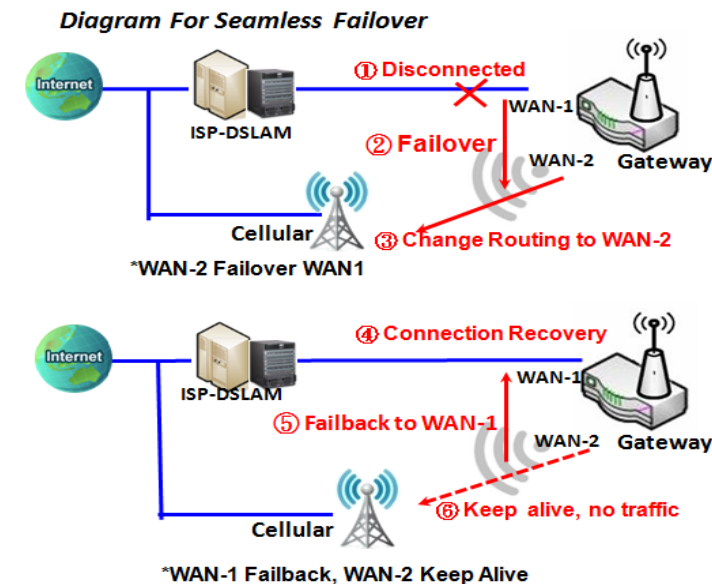

In addition, there is a "Seamless" option for Failover operation mode. When seamless option is activated by checking on the "Seamless" box in configuration window, both the primary connection and the failover connection are started up after system rebooting. But only the primary connection executes the data transfer, while the failover one just keeps alive of connection line. As soon as the primary connection is broken, the system will switch, meaning failover, the routing path to the failover connection to save the dial up time of failover connection since it has been alive.

When the "Seamless" enable checkbox is activated, it

# 4G LTE M2M Router

can allow the Failover interface to be connected continuously from system booting up. Failover WAN interface just keeps connecting without data traffic. The purpose is to shorten the switch time during failover process. So, when primary connection is disconnected, failover interface will take over the data transfer mission instantly by only changing routing path to the failover interface. The dialing-up time of failover connection is saved since it has been connected beforehand.

## **VLAN Tagging**

Sometimes, your ISP required a VLAN tag to be inserted into the WAN packets from Gateway for specific services. Please enable VLAN tagging and specify tag in the WAN physical interface. Please be noted that only Ethernet and ADSL physical interfaces support the feature. For the device with 3G/4G WAN only, it is disabled.

# 4G LTE M2M Router

## Physical Interface Setting

Go to **Basic Network > WAN > Physical Interface** tab.

The Physical Interface allows user to setup the physical WAN interface and to adjust WAN's behavior.

Note: Numbers of available WAN Interfaces can be different for the purchased gateway.

Physical Interface List			
Interface Name	Physical Interface	Operation Mode	Action
WAN-1	Ethernet	Always on	<input type="button" value="Edit"/>
WAN-2	3G/4G	Always on	<input type="button" value="Edit"/>
WAN-3	-	Disable	<input type="button" value="Edit"/>
WAN-4	-	Disable	<input type="button" value="Edit"/>

When **Edit** button is applied, an **Interface Configuration** screen will appear. WAN-1 interface is used in this example.

## Interface Configuration:

Interface Configuration ( WAN - 1 )	
Item	Setting
Physical Interface	<input type="text" value="Ethernet"/>
Operation Mode	<input type="text" value="Always on"/>
VLAN Tagging	<input type="checkbox"/> Enable <input type="text" value="2"/> (1-4095)

Interface Configuration		
Item	Value setting	Description
<b>Physical Interface</b>	1. A Must fill setting 2. WAN-1 is the primary interface and is factory set to Always on.	Select one expected interface from the available interface dropdown list. It can be <b>3G/4G</b> , <b>Ethernet</b> or <b>WiFi Module</b> . Depending on the gateway model, <b>Disable</b> and <b>Failover</b> options will be available only to multiple WAN gateways. WAN-2 ~ WAN-4 interfaces are only available to multiple WAN gateway.
<b>Operation Mode</b>	A Must fill setting	Define the operation mode of the interface. Select <b>Always on</b> to make this WAN always active. Select <b>Disable</b> to disable this WAN interface. Select <b>Failover</b> to make this WAN a Failover WAN when the primary or the

# 4G LTE M2M Router

		<p>secondary WAN link failed. Then select the primary or the existed secondary WAN interface to switch Failover from.</p> <p>(Note: for WAN-1, only <b>Always on</b> option is available.)</p>
<b>VLAN Tagging</b>	Optional setting	<p>Check <b>Enable</b> box to enter tag value provided by your ISP. Otherwise uncheck the box.</p> <p><b><u>Value Range:</u> 1 ~ 4095.</b></p> <p>Note: This feature is NOT available for 3G/4G WAN connection.</p>

# 4G LTE M2M Router

## 2.1.2 Internet Setup

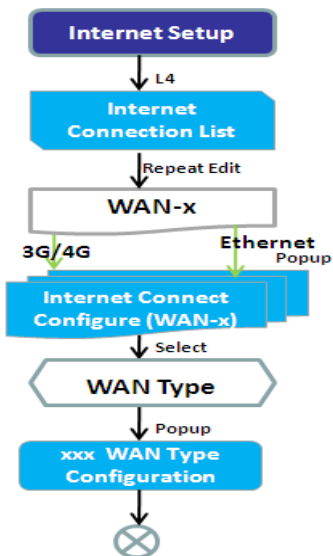

Internet Connection List				
Interface Name	Physical Interface	Operation Mode	WAN Type	Action
WAN-1	Ethernet	Always on	Static IP	<a href="#">Edit</a>
WAN-2	3G/4G	Always on	3G/4G	<a href="#">Edit</a>
WAN-3	-	Disable	-	<a href="#">Edit</a>
WAN-4	-	Disable	-	<a href="#">Edit</a>

Internet Connection Configuration ( WAN - 1 )	
Item	Setting
WAN Type	Dynamic IP ▼

Dynamic IP WAN Type Configuration	
Item	Setting
Host Name	<input type="text"/> (Optional)
ISP Registered MAC Address	<input type="text"/> (Optional)
Connection Control	Auto-reconnect ▼
MTU Setup	<input type="checkbox"/> Enable
NAT	<input checked="" type="checkbox"/> Enable
IGMP	Disable ▼
WAN IP Alias	<input type="checkbox"/> Enable <input type="text" value="10.0.0.1"/>

After specifying the physical interface for each WAN connection, administrator must configure their connection profile to meet the dial in process of ISP, so that all client hosts in the Intranet of the gateway can access the Internet.

In "Internet Setup" page, there are some configuration windows: "Internet Connection List", "Internet Connection Configuration", "WAN Type Configuration" and related configuration windows for each WAN type. For the Internet setup of each WAN interface, you must specify its WAN type of physical interface first and then its related parameter configuration for that WAN type.

After clicking on the "Edit" button of a physical interface in "Internet Setup List" window, the "Internet Connection Configuration" window will appear to let you specify which kind of WAN type that you will use for that physical interface to make an Internet connection. Based on your chosen WAN type, you can configure necessary parameters in each corresponding configuration window.

# 4G LTE M2M Router

## Internet Connection List - Ethernet WAN

Item	Setting
▶ WAN Type	Dynamic IP ▼
<b>Dynamic IP WAN Type Conf</b>	
Item	Setting
▶ Host Name	(Optional)
▶ ISP Registered MAC Address	Clone (Optional)
▶ Connection Control	Auto-reconnect ▼
▶ MTU Setup	<input type="checkbox"/> Enable
▶ NAT	<input checked="" type="checkbox"/> Enable
▶ IGMP	Disable ▼
▶ WAN IP Alias	<input type="checkbox"/> Enable 10.0.0.1
<b>Network Monitoring Configuration</b>	
Item	Setting
▶ Network Monitoring Configuration	<input checked="" type="checkbox"/> Enable
▶ Checking Method	DNS Query ▼
▶ Loading Check	<input checked="" type="checkbox"/> Enable
▶ Query Interval	5 (seconds)
▶ Latency Threshold	3000 (ms)

### **WAN Type for Ethernet Interface:**

Ethernet is the most common WAN and uplink interface for M2M gateways. Usually it is connected with xDSL or cable modem for you to setup the WAN connection. There are various WAN types to connect with ISP.

- **Static IP:** Select this option if ISP provides a fixed IP to you when you subscribe the service. Usually is more expensive but very important for cooperate requirement.
- **Dynamic IP:** The assigned IP address for the WAN by a DHCP server is different every time. It is cheaper and usually for consumer use.
- **PPP over Ethernet:** As known as PPPoE. This WAN type is widely used for ADSL connection. IP is usually different for every dial up.
- **PPTP:** This WAN type is popular in some countries, like Russia.
- **L2TP :** This WAN type is popular in some countries, like Israel.

### **Configure Ethernet WAN Setting**

When **Edit** button is applied, **Internet Connection Configuration** screen will appear. WAN-1 interface is used in this example.

# 4G LTE M2M Router

## WAN Type = Dynamic IP

Internet Connection Configuration ( WAN - 1 )	
Item	Setting
▶ WAN Type	Dynamic IP ▼

When you select it, "Dynamic IP WAN Type Configuration" will appear. Items and setting is explained below

Dynamic IP WAN Type Configuration	
Item	Setting
▶ Host Name	<input type="text"/> (Optional)
▶ ISP Registered MAC Address	<input type="text"/> <input type="button" value="Clone"/> (Optional)

Dynamic IP WAN Type Configuration		
Item	Value setting	Description
Host Name	An optional setting	Enter the host name provided by your Service Provider.
ISP Registered MAC Address	An optional setting	Enter the MAC address that you have registered with your service provider. Or Click the <b>Clone</b> button to clone your PC's MAC to this field. Usually this is the PC's MAC address assigned to allow you to connect to Internet.

## WAN Type= Static IP

Internet Connection Configuration ( WAN - 1 )	
Item	Setting
▶ WAN Type	Static IP ▼

When you select it, "Static IP WAN Type Configuration" will appear. Items and setting is explained below

Static IP WAN Type Configuration	
Item	Setting
▶ WAN IP Address	<input type="text"/>
▶ WAN Subnet Mask	255.255.255.0 (/24) ▼
▶ WAN Gateway	<input type="text"/>
▶ Primary DNS	<input type="text"/>
▶ Secondary DNS	<input type="text"/> (Optional)

# 4G LTE M2M Router

Static IP WAN Type Configuration		
Item	Value setting	Description
<b>WAN IP Address</b>	A Must filled setting	Enter the WAN IP address given by your Service Provider
<b>WAN Subnet Mask</b>	A Must filled setting	Enter the WAN subnet mask given by your Service Provider
<b>WAN Gateway</b>	A Must filled setting	Enter the WAN gateway IP address given by your Service Provider
<b>Primary DNS</b>	A Must filled setting	Enter the primary WAN DNS IP address given by your Service Provider
<b>Secondary DNS</b>	An optional setting	Enter the secondary WAN DNS IP address given by your Service Provider

## WAN Type= PPPoE

Internet Connection Configuration ( WAN - 1 )

Item	Setting
▶ WAN Type	<input style="width: 100%;" type="text" value="PPPoE"/>

When you select it, "PPPoE WAN Type Configuration" will appear. Items and setting is explained below

PPPoE WAN Type Configuration

Item	Setting
▶ IP Type	<input style="width: 100%;" type="text" value="IPv4"/>
▶ PPPoE Account	<input style="width: 100%;" type="text"/>
▶ PPPoE Password	<input style="width: 100%;" type="text"/>
▶ Primary DNS	<input style="width: 100%;" type="text"/> (Optional)
▶ Secondary DNS	<input style="width: 100%;" type="text"/> (Optional)
▶ Service Name	<input style="width: 100%;" type="text"/> (Optional)
▶ Assigned IP Address	<input style="width: 100%;" type="text"/> (Optional)

PPPoE WAN Type Configuration		
Item	Value setting	Description
<b>PPPoE Account</b>	A Must filled setting	Enter the PPPoE User Name provided by your Service Provider.
<b>PPPoE Password</b>	A Must filled setting	Enter the PPPoE password provided by your Service Provider.
<b>Primary DNS</b>	An optional setting	Enter the IP address of Primary DNS server.
<b>Secondary DNS</b>	An optional setting	Enter the IP address of Secondary DNS server.
<b>Service Name</b>	An optional setting	Enter the service name if your ISP requires it
<b>Assigned IP Address</b>	An optional setting	Enter the IP address assigned by your Service Provider.

# 4G LTE M2M Router

## WAN Type= PPTP

Internet Connection Configuration ( WAN - 1 )	
Item	Setting
▶ WAN Type	PPTP ▼

When you select it, "PPTP WAN Type Configuration" will appear. Items and setting is explained below

PPTP WAN Type Configuration	
Item	Setting
▶ IP Mode	Dynamic IP Address ▼
▶ Server IP Address / Name	<input type="text"/>
▶ PPTP Account	<input type="text"/>
▶ PPTP Password	<input type="text"/>
▶ Connection ID	<input type="text"/> (Optional)
▶ MPPE	<input type="checkbox"/> Enable

PPTP WAN Type Configuration		
Item	Value setting	Description
IP Mode	A Must filled setting	<p>Select either Static or Dynamic IP address for PPTP Internet connection.</p> <ul style="list-style-type: none"> <li>● When <b>Static IP Address</b> is selected, you will need to enter the <b>WAN IP Address, WAN Subnet Mask, and WAN Gateway</b>. <ul style="list-style-type: none"> <li>■ <b>WAN IP Address</b> (A Must filled setting): Enter the WAN IP address given by your Service Provider.</li> <li>■ <b>WAN Subnet Mask</b> (A Must filled setting): Enter the WAN subnet mask given by your Service Provider.</li> <li>■ <b>WAN Gateway</b> (A Must filled setting): Enter the WAN gateway IP address given by your Service Provider.</li> </ul> </li> <li>● When <b>Dynamic IP</b> is selected, there are no above settings required.</li> </ul>
Server IP Address/Name	A Must filled setting	Enter the PPTP server name or IP Address.
PPTP Account	A Must filled setting	Enter the PPTP username provided by your Service Provider.
PPTP Password	A Must filled setting	Enter the PPTP connection password provided by your Service Provider.
Connection ID	An optional setting	Enter a name to identify the PPTP connection.
MPPE	An optional setting	Select <b>Enable</b> to enable MPPE (Microsoft Point-to-Point Encryption) security for PPTP connection.

# 4G LTE M2M Router

## WAN Type= L2TP

Internet Connection Configuration ( WAN - 1 )	
Item	Setting
▶ WAN Type	L2TP ▼

When you select it, "L2TP WAN Type Configuration" will appear. Items and setting is explained below

L2TP WAN Type Configuration	
Item	Setting
▶ IP Mode	Dynamic IP Address ▼
▶ Server IP Address / Name	<input type="text"/>
▶ L2TP Account	<input type="text"/>
▶ L2TP Password	<input type="text"/>
▶ Service Port	User-defined ▼ <input type="text" value="1702"/>
▶ MPPE	<input type="checkbox"/> Enable

L2TP WAN Type Configuration		
Item	Value setting	Description
IP Mode	A Must filled setting	<p>Select either Static or Dynamic IP address for L2TP Internet connection.</p> <ul style="list-style-type: none"> <li>When <b>Static IP Address</b> is selected, you will need to enter the <b>WAN IP Address, WAN Subnet Mask, and WAN Gateway</b>. <ul style="list-style-type: none"> <li><b>WAN IP Address</b> (A Must filled setting): Enter the WAN IP address given by your Service Provider.</li> <li><b>WAN Subnet Mask</b> (A Must filled setting): Enter the WAN subnet mask given by your Service Provider.</li> <li><b>WAN Gateway</b> (A Must filled setting): Enter the WAN gateway IP address given by your Service Provider.</li> </ul> </li> <li>When <b>Dynamic IP</b> is selected, there are no above settings required.</li> </ul>
Server IP Address/Name	A Must filled setting	Enter the L2TP server name or IP Address.
L2TP Account	A Must filled setting	Enter the L2TP username provided by your Service Provider.
L2TP Password	A Must filled setting	Enter the L2TP connection password provided by your Service Provider.
Service Port	A Must filled setting	<p>Enter the service port that the Internet service.</p> <p>There are three options can be selected :</p> <ul style="list-style-type: none"> <li><b>Auto</b>: Port will be automatically assigned.</li> <li><b>1701 (For Cisco)</b>: Set service port to port 1701 to connect to CISCO server.</li> <li><b>User-defined</b>: enter a service port provided by your Service Provider.</li> </ul>
MPPE	An optional setting	Select <b>Enable</b> to enable MPPE (Microsoft Point-to-Point Encryption) security for PPTP connection.

# 4G LTE M2M Router

## Ethernet Connection Common Configuration

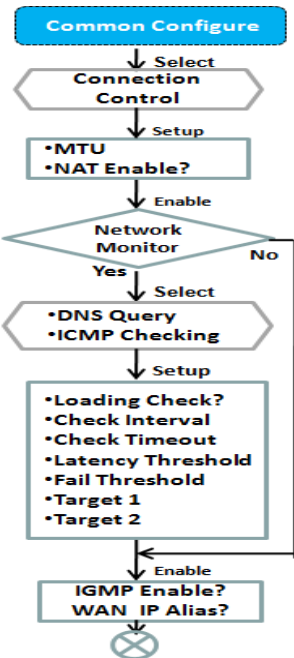

▶ Connection Control	Auto-reconnect ▼
▶ MTU Setup	<input type="checkbox"/> Enable
▶ NAT	<input checked="" type="checkbox"/> Enable
▶ IGMP	Disable ▼
▶ WAN IP Alias	<input type="checkbox"/> Enable 10.0.0.1
<b>Network Monitoring Configuration</b>	
▶ Network Monitoring Configuration	<input checked="" type="checkbox"/> Enable
▶ Checking Method	DNS Query ▼
▶ Loading Check	<input checked="" type="checkbox"/> Enable
▶ Query Interval	5 (seconds)
▶ Latency Threshold	3000 (ms)
▶ Fail Threshold	5 (Times)
▶ Target1	DNS1 ▼
▶ Target2	None ▼

There are some important parameters to be setup no matter which Ethernet WAN type is selected. You should follow up the rule to configure.

### Connection Control.

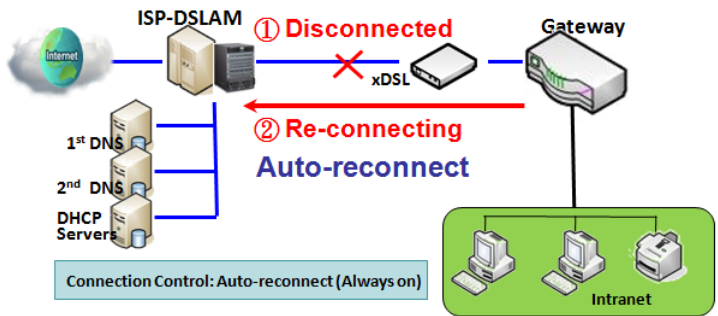

**Auto-reconnect:** This gateway will establish Internet connection automatically once it has been booted up, and try to reconnect once the connection is down. It's recommended to choose this scheme if for mission critical applications to ensure full-time Internet connection.

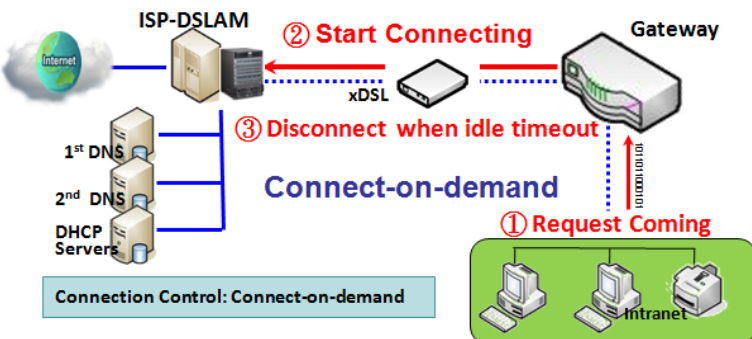

**Connect-on-demand:** This gateway won't start to establish Internet connection until local data is going to be sent to WAN side. After normal data transferring between LAN and WAN sides, this gateway will disconnect WAN connection if idle time reaches value of Maximum Idle Time.

# 4G LTE M2M Router

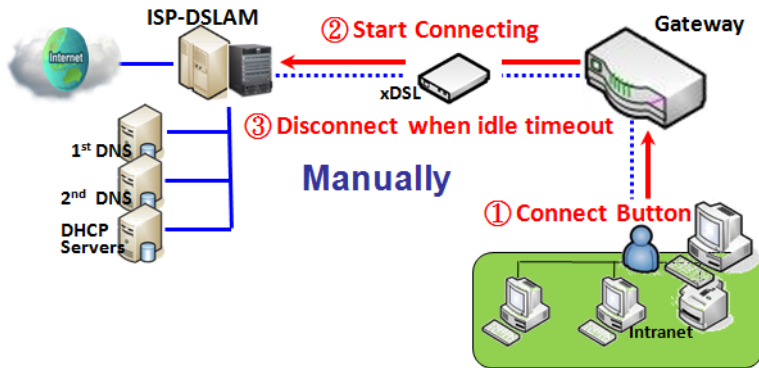

**Manually:** This gateway won't start to establish WAN connection until you press "Connect" button on web UI. After normal data transferring between LAN and WAN sides, this gateway will disconnect WAN connection if idle time reaches value of Maximum Idle Time.

Please be noted, if the WAN interface serves as the primary one for another WAN interface in Failover role, the Connection Control parameter will not be available to you to configure as the system must set it to "Auto-reconnect (Always on)".

## Network Monitoring

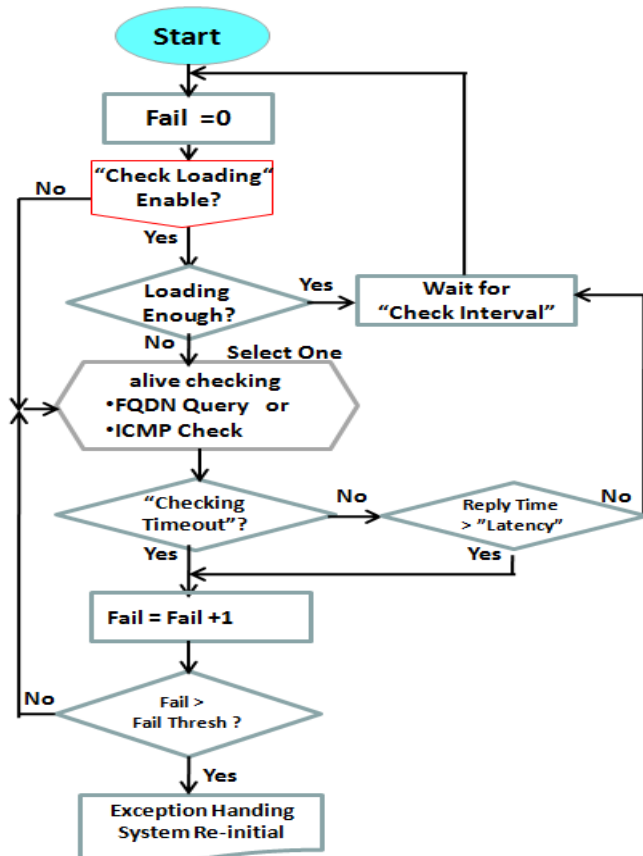

It is necessary to monitor connection status continuous. To do it, "ICMP Check" and "FQDN Query" are used to check. When there is traffic of connection, checking packet will waste bandwidth. Response time of replied packets may also increase. To avoid "Network Monitoring" work abnormally, enabling "Checking Loading" option will stop connection check when there is traffic. It will wait for another "Check Interval" and then check loading again.

When you do "Network Monitoring", if reply time longer than "Latency" or even no response longer than "Checking Timeout", "Fail" count will be increased. If it is continuous and "Fail" count is more than "Fail Threshold", gateway will do exception handling process and re-initial this connection again. Otherwise, network monitoring process will be start again.

# 4G LTE M2M Router

## Set up “Ethernet Common Configuration”

Ethernet WAN Common Configuration		
Item	Value setting	Description
<b>Connection Control</b>	A Must filled setting	<p>There are three connection modes.</p> <ul style="list-style-type: none"> <li>• <b>Auto-reconnect</b> enables the router to always keep the Internet connection on.</li> <li>• <b>Connect-on-demand</b> enables the router to automatically re-establish Internet connection as soon as user attempts to access the Internet. Internet connection will be disconnected when it has been inactive for a specified idle time.</li> <li>• <b>Connect Manually</b> allows user to connect to Internet manually. Internet connection will be inactive after it has been inactive for specified idle time.</li> </ul>
<b>Maximum Idle Time</b>	<ol style="list-style-type: none"> <li>1. An Optional setting</li> <li>2. By default <b>600</b> seconds is filled-in</li> </ol>	<p>Specify the maximum Idle time setting to disconnect the internet connection when the connection idle timed out.</p> <p><b>Value Range:</b> 300 ~ 86400.</p> <p><b>Note:</b> This field is available only when <b>Connect-on-demand</b> or <b>Connect Manually</b> is selected as the connection control scheme.</p>
<b>MTU Setup</b>	<ol style="list-style-type: none"> <li>1. An Optional setting</li> <li>2. <b>Uncheck</b> by default</li> </ol>	<p>Check the Enable box to enable the MTU (Maximum Transmission Unit) limit, and specify the <b>MTU</b> for the 3G/4G connection.</p> <p><b>MTU</b> refers to Maximum Transmission Unit. It specifies the largest packet size permitted for Internet transmission.</p> <p><b>Value Range:</b> 1200 ~ 1500.</p>
<b>MTU Setup</b>	<ol style="list-style-type: none"> <li>1. A Must filled setting</li> <li>2. <b>Auto</b> (value zero) is set by default</li> <li>3. Manual set range 1200~1500</li> </ol>	<p><b>MTU</b> refers to Maximum Transmission Unit. It specifies the largest packet size permitted for Internet transmission.</p> <p>When set to <b>Auto</b> (value '0'), the router selects the best MTU for best Internet connection performance.</p>
<b>NAT</b>	<ol style="list-style-type: none"> <li>1. An optional setting</li> <li>2. NAT is enabled by default</li> </ol>	<p>Enable NAT to apply NAT on the WAN connection. Uncheck the box to disable NAT function.</p>
<b>IGMP</b>	<ol style="list-style-type: none"> <li>1. A Must filled setting</li> <li>2. Disable is set by default</li> </ol>	<p>Enable IGMP (Internet Group Management Protocol) would enable the router to listen to IGMP packets to discover which interfaces are connected to which device. The router uses the interface information generated by IGMP to reduce bandwidth consumption in a multi-access network environment to avoid flooding the entire network.</p>
<b>WAN IP Alias</b>	<ol style="list-style-type: none"> <li>1. An optional setting</li> <li>2. <b>Uncheck</b> by default</li> </ol>	<p>Enable <b>WAN IP Alias</b> then enter the IP address provided by your service provider.</p> <p><b>WAN IP Alias</b> is used by the device router and is treated as a second set of WAN IP to provide dual WAN IP address to your LAN network.</p>

# 4G LTE M2M Router

Network Monitoring Configuration	
Item	Setting
▶ Network Monitoring Configuration	<input checked="" type="checkbox"/> Enable
▶ Checking Method	DNS Query ▼
▶ Loading Check	<input checked="" type="checkbox"/> Enable
▶ Query Interval	5 (seconds)
▶ Latency Threshold	3000 (ms)
▶ Fail Threshold	5 (Times)
▶ Target1	DNS1 ▼
▶ Target2	None ▼

Network Monitoring Configuration		
Item	Value setting	Description
<b>Network Monitoring Configuration</b>	1. An optional setting 2. Box is checked by default	Check the <b>Enable</b> box to activate the network monitoring function.
<b>Checking Method</b>	1. An Optional setting 2. <b>DNS Query</b> is set by default	Choose either <b>DNS Query</b> or <b>ICMP Checking</b> to detect WAN link. With <b>DNS Query</b> , the system checks the connection by sending DNS Query packets to the destination specified in Target 1 and Target 2. With <b>ICMP Checking</b> , the system will check connection by sending ICMP request packets to the destination specified in Target 1 and Target 2.
<b>Loading Check</b>	1. An optional setting 2. Box is checked by default	Check the <b>Enable</b> box to activate the loading check function. Enable Loading Check allows the gateway to ignore unreturned DNS queries or ICMP requests when WAN bandwidth is fully occupied. This is to prevent false link-down status.
<b>Query Interval</b>	1. An Optional setting 2. <b>5 seconds</b> is selected by default.	Specify a time interval as the <b>DNS Query Interval</b> . <b>Query Interval</b> defines the transmitting interval between two DNS Query or ICMP checking packets. With <b>DNS Query</b> , the system checks the connection by sending DNS Query packets to the destination specified in Target 1 and Target 2. <b>Value Range:</b> 2 ~ 14400.
<b>Check Interval</b>	1. An Optional setting 2. <b>5 seconds</b> is selected by default.	Specify a time interval as the <b>ICMP Checking Interval</b> . <b>Query Interval</b> defines the transmitting interval between two DNS Query or ICMP checking packets. With <b>ICMP Checking</b> , the system will check connection by sending ICMP request packets to the destination specified in Target 1 and Target 2. <b>Value Range:</b> 2 ~ 14400.
<b>Latency Threshold</b>	1. An Optional setting 2. <b>3000 ms</b> is set by default	Enter a number of detecting disconnection times to be the threshold before disconnection is acknowledged. <b>Latency Threshold</b> defines the tolerance threshold of responding time. <b>Value Range:</b> 2000 ~ 3000 seconds.
<b>Fail Threshold</b>	1. An Optional setting 2. <b>5 times</b> is set by default	Enter a number of detecting disconnection times to be the threshold before disconnection is acknowledged. <b>Fail Threshold</b> specifies the detected disconnection before the router recognize the WAN link down status.

# 4G LTE M2M Router

		<b><i>Value Range:</i></b> 1 ~ 10 times.
<b>Target 1</b>	<ol style="list-style-type: none"> <li>1. An Optional filled setting</li> <li>2. <b>DNS1</b> is selected by default</li> </ol>	<b>Target1</b> specifies the first target of sending DNS query/ICMP request. <b>DNS1:</b> set the primary DNS to be the target. <b>DNS2:</b> set the secondary DNS to be the target. <b>Gateway:</b> set the Current gateway to be the target. <b>Other Host:</b> enter an IP address to be the target.
<b>Target 2</b>	<ol style="list-style-type: none"> <li>1. An Optional filled setting</li> <li>2. <b>None</b> is selected by default</li> </ol>	<b>Target1</b> specifies the second target of sending DNS query/ICMP request. <b>None:</b> no second target is required. <b>DNS1:</b> set the primary DNS to be the target. <b>DNS2:</b> set the secondary DNS to be the target. <b>Gateway:</b> set the Current gateway to be the target. <b>Other Host:</b> enter an IP address to be the target.
<b>Save</b>	N/A	Click <b>Save</b> to save the settings.
<b>Undo</b>	N/A	Click <b>Undo</b> to cancel the settings.

# 4G LTE M2M Router

## Internet Connection – 3G/4G WAN

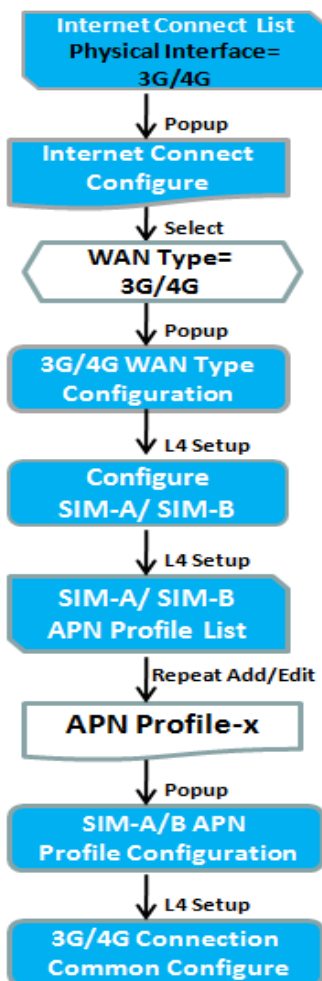

Internet Connection Configuration ( WAN - 2)	
Item	Setting
▶ WAN Type	3G/4G ▼
3G/4G WAN Type Configuration	
Item	Setting
▶ Preferred SIM Card	SIM-A First ▼ Failback: <input type="checkbox"/> Enable
▶ Auto Flight Mode	<input type="checkbox"/> Enable
▶ SIM Switch Policy	Policy Setting
Connection with SIM-A Card	
Connection with SIM-B Card	
3G/4G Connection Common Configuration	
Item	Setting
▶ Connection Control	Auto-reconnect ▼
▶ Time Schedule	(0) Always ▼
▶ MTU Setup	<input type="checkbox"/> Enable

## Preferred SIM Card – Dual SIM Fail Over

For 3G/4G embedded device, one embedded cellular module can create only one WAN interface. This device has featured by using dual SIM cards for one module with special fail-over mechanism. It is called Dual SIM Failover. This feature is useful for ISP switch over when location is changed. Within “Dual SIM Failover”, there are various usage scenarios, including “SIM-A First”, “SIM-B First” with “Failback” enabled or not, and “SIM-A Only and “SIM-B Only”.

# 4G LTE M2M Router

**SIM-A/SIM-B only:** When “SIM-A Only” or “SIM-B Only” is used, the specified SIM slot card is the only one to be used for negotiation parameters between gateway device and cellular ISP.

## SIM-A / SIM-B first without enable Failback

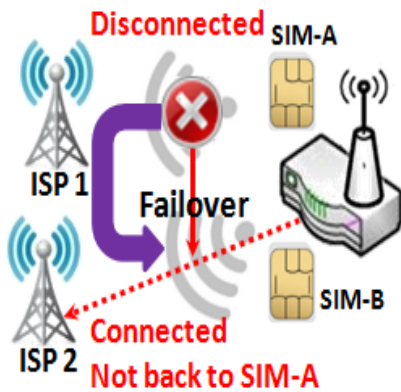

By default, “SIM-A First” scenario is used to connect to cellular ISP for data transfer. In the case of “SIM-A First” or “SIM-B First” scenario, the gateway will try to connect to the Internet by using SIM-A or SIM-B card first. And when the connection is broken, the gateway will switch to use the other SIM card for an alternate automatically and **will not switch back** to use original SIM card except current SIM connection is also broken. That is, SIM-A and SIM-B are used iteratively, but either one will keep being used for data transfer when current connection is still alive.

## SIM-A / SIM-B first with Failback enable

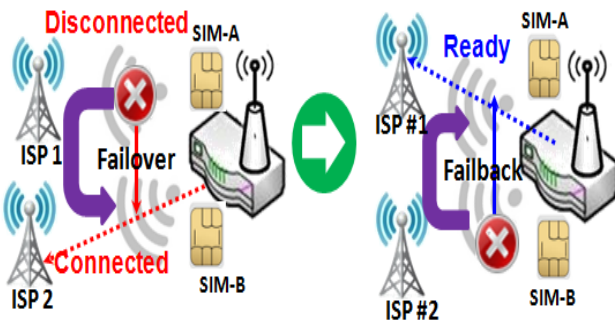

With Failback option enabled, “SIM-A First” scenario is used to connect when the connection is broken, gateway system will switch to use SIM-B. And when SIM-A connection is recovered, it will switch back to use original SIM-A card

# 4G LTE M2M Router

## Configure 3G/4G WAN Setting

When **Edit** button is applied, **Internet Connection Configuration**, and **3G/4G WAN Configuration** screens will appear.

Internet Connection Configuration ( WAN - 2 )	
Item	Setting
▶ WAN Type	3G/4G ▼

3G/4G WAN Type Configuration	
Item	Setting
▶ Preferred SIM Card	SIM-A First ▼ Failback : <input type="checkbox"/> Enable
▶ Auto Flight Mode	<input type="checkbox"/> Enable
▶ SIM Switch Policy	Policy Setting

3G/4G Connection Configuration		
Item	Value setting	Description
<b>WAN Type</b>	1. A Must filled setting 2. <b>3G/4G</b> is set by default.	From the dropdown box, select Internet connection method for 3G/4G WAN Connection. Only <b>3G/4G</b> is available.
<b>Preferred SIM Card</b>	1. A Must filled setting 2. By default <b>SIM-A First</b> is selected 3. <b>Failback</b> is unchecked by default	Choose which SIM card you want to use for the connection. When <b>SIM-A First</b> or <b>SIM-B First</b> is selected, it means the connection is built first by using SIM A/SIM B. And if the connection is failed, it will change to the other SIM card and try to dial again, until the connection is up. When <b>SIM-A only</b> or <b>SIM-B only</b> is selected, it will try to dial up only using the SIM card you selected. When <b>Failback</b> is checked, it means if the connection is dialed-up not using the main SIM you selected, it will fallback to the main SIM and try to establish the connection periodically. <b>Note_1:</b> For the product with single SIM design, only <b>SIM-A Only</b> option is available. <b>Note_2:</b> <b>Failback</b> is available only when <b>SIM-A First</b> or <b>SIM-B First</b> is selected.
<b>Auto Flight Mode</b>	The box is unchecked by default	Check the <b>Enable</b> box to activate the function. By default, if you disabled the <b>Auto Flight Mode</b> , the cellular module will always occupy a physical channel with cellular tower. It can get data connection instantly, and receive managing SMS all the time on required. If you enabled the <b>Auto Flight Mode</b> , the gateway will pop up a message " <i>Flight mode will cause cellular function to be malfunctioned when the data session is offline.</i> "; and it will make the cellular module into flight mode and disconnected with cellular tower phycially. In, addition, whenever the cellular module is going to be used for data connection to backup the failed primary connection, the cellular module will be active to connect with cellular tower and get the data connection for use, It takes few more seconds.

# 4G LTE M2M Router

		<b>Note:</b> Keep it unchecked unless your cellular ISP asked the connected gateway to enable the Auto Flight Mode.
<b>SIM Switch Policy</b>	NA	Click the <b>Policy Setting</b> button to define the SIM Switch policy or browse the current policy settings.

Policy Setting	
Item	Setting
▶ Failed connection	<input type="text" value="0"/> (1-10) times
▶ RSSI Monitor	<input type="checkbox"/> Enable Threshold: - <input type="text" value="0"/> (-90~-113 dBm)
▶ Network Service	<input type="checkbox"/> Enable Loss LTE signal: <input type="text" value="0"/> (1~30 minutes)
▶ Roaming Service	<input type="checkbox"/> Enable Timeout: <input type="text" value="0"/> (1~30 minutes)

## Configure SIM-A / SIM-B Card

Here you can set configurations for the cellular connection according to your situation or requirement.

Connection with SIM-A Card	
Item	Setting
▶ Network Type	<input type="text" value="Auto"/> ▼
▶ Dial-Up Profile	<input type="text" value="Manual-configuration"/> ▼
▶ APN	<input type="text"/>
▶ PIN Code	<input type="text"/> (Optional)
▶ Dial Number	<input type="text"/> (Optional)
▶ Account	<input type="text"/> (Optional)
▶ Password	<input type="text"/> (Optional)
▶ Authentication	<input type="text" value="Auto"/> ▼
▶ IP Mode	<input type="text" value="Dynamic IP"/> ▼
▶ Primary DNS	<input type="text"/> (Optional)
▶ Secondary DNS	<input type="text"/> (Optional)
▶ Roaming	<input type="checkbox"/> Enable

Note\_1: Configurations of SIM-B Card follows the same rule of Configurations of SIM-A Card, here we list SIM-A as the example.

Note\_2: Both **Connection with SIM-A Card** and **Connection with SIM-B Card** will pop up only when the **SIM-A First** or **SIM-B First** is selected, otherwise it only pops out one of them.

# 4G LTE M2M Router

Connection with SIM-A/-B Card		
Item	Value setting	Description
<b>Network Type</b>	1. A Must filled setting 2. By default <b>Auto</b> is selected	Select <b>Auto</b> to register a network automatically, regardless of the network type. Select <b>2G Only</b> to register the 2G network only. Select <b>2G Prefer</b> to register the 2G network first if it is available. Select <b>3G only</b> to register the 3G network only. Select <b>3G Prefer</b> to register the 3G network first if it is available. Select <b>LTE only</b> to register the LTE network only.  <b>Note:</b> Options may be different due to the specification of the module.
<b>Dial-Up Profile</b>	1. A Must filled setting 2. By default <b>Manual-configuration</b> is selected	Specify the type of dial-up profile for your 3G/4G network. It can be <b>Manual-configuration</b> , <b>APN Profile List</b> , or <b>Auto-detection</b> .  Select <b>Manual-configuration</b> to set <b>APN</b> (Access Point Name), <b>Dial Number</b> , <b>Account</b> , and <b>Password</b> to what your carrier provides. Select <b>APN Profile List</b> to set more than one profile to dial up in turn, until the connection is established. It will pop up a new filed, please go to <b>Basic Network &gt; WAN &amp; Uplink &gt; Internet Setup &gt; SIM-A APN Profile List</b> for details. Select <b>Auto-detection</b> to automatically bring out all configurations needed while dialing-up, by comparing the IMSI of the SIM card to the record listed in the manufacturer's database.  <b>Note_1:</b> You are highly recommended to select the <b>Manual</b> or <b>APN Profile List</b> to specify the network for your subscription. Your ISP always provides such network settings for the subscribers. <b>Note_2:</b> If you select <b>Auto-detection</b> , it is likely to connect to improper network, or failed to find a valid APN for your ISP.
<b>APN</b>	1. A Must filled setting 2. String format : any text	Enter the <b>APN</b> you want to use to establish the connection. This is a must-filled setting if you selected <b>Manual-configuration</b> as dial-up profile scheme.
<b>IP Type</b>	1. A Must filled setting 2. By default <b>IPv4</b> is selected	Specify the IP type of the network service provided by your 3G/4G network. It can be <b>IPv4</b> , <b>IPv6</b> , or <b>IPv4/6</b> .
<b>PIN code</b>	1. An Optional setting 2. String format : interger	Enter the PIN (Personal Identification Number) code if it needs to unlock your SIM card.
<b>Dial Number, Account, Password</b>	1. An Optional setting 2. String format : any text	Enter the optional <b>Dial Number</b> , <b>Account</b> , and <b>Password</b> settings if your ISP provided such settings to you. <b>Note:</b> These settings are only displayed when Manual-configuration is selected.
<b>Authentication</b>	1. A Must filled setting 2. By default <b>Auto</b> is selected	Select <b>PAP</b> (Password Authentication Protocol) and use such protocol to be authenticated with the carrier's server. Select <b>CHAP</b> (Challenge Handshake Authentication Protocol) and use such protocol to be authenticated with the carrier's server. When <b>Auto</b> is selected, it means it will authenticate with the server either <b>PAP</b> or <b>CHAP</b> .
<b>IP Mode</b>	1. A Must filled setting 2. By default <b>Dynamic IP</b> is selected	When <b>Dynamic IP</b> is selected, it means it will get all IP configurations from the carrier's server and set to the device directly. If you have specific application provided by the carrier, and want to set IP

# 4G LTE M2M Router

		configurations on your own, you can switch to <b>Static IP</b> mode and fill in all parameters that required, such as IP address, subnet mask and gateway.  <b>Note:</b> <b>IP Subnet Mask</b> is a must filled setting, and make sure you have the right configuration. Otherwise, the connection may get issues.
<b>Primary DNS</b>	1. An Optional setting 2. String format : IP address (IPv4 type)	Enter the IP address to change the primary DNS (Domain Name Server) setting. If it is not filled-in, the server address is given by the carrier while dialing-up.
<b>Secondary DNS</b>	1. An Optional setting 2. String format : IP address (IPv4 type)	Enter the IP address to change the secondary DNS (Domain Name Server) setting. If it is not filled-in, the server address is given by the carrier while dialing-up.
<b>Roaming</b>	The box is unchecked by default	Check the box to establish the connection even the registration status is roaming, not in home network.  <b>Note:</b> It may cost additional charges if the connection is under roaming.

## Create/Edit SIM-A / SIM-B APN Profile List

You can add a new APN profile for the connection, or modify the content of the APN profile you added. It is available only when you select **Dial-Up Profile** as **APN Profile List**.

SIM-A APN Profile List <span>Add</span> <span>Delete</span>									
ID	Profile Name	APN	IP Type	Account	Password	Authentication	Priority	Enable	Actions

List all the APN profile you created, easily for you to check and modify. It is available only when you select **Dial-Up Profile** as **APN Profile List**.

When **Add** button is applied, an **APN Profile Configuration** screen will appear.

SIM-A APN Profile Configuration	
Item	Setting
▶ Profile Name	<input type="text" value="Profile-1"/>
▶ APN	<input type="text"/>
▶ IP Type	IPv4 ▼
▶ Account	<input type="text"/> (Optional)
▶ Password	<input type="text"/> (Optional)
▶ Authentication	Auto ▼
▶ Priority	<input type="text"/>
▶ Profile	<input type="checkbox"/> Enable

SIM-A/-B APN Profile Configuration		
Item	Value setting	Description
<b>Profile Name</b>	1. By default <b>Profile-x</b> is	Enter the profile name you want to describe for this profile.

# 4G LTE M2M Router

	listed 2. String format : any text	
<b>APN</b>	String format : any text	Enter the <b>APN</b> you want to use to establish the connection.
<b>IP Type</b>	1. A Must filled setting 2. By default <b>IPv4</b> is selected	Specify the IP type of the network service provided by your 3G/4G network. It can be <b>IPv4</b> , <b>IPv6</b> , or <b>IPv4/6</b> .
<b>Account</b>	String format : any text	Enter the <b>Account</b> you want to use for the authentication. <b>Value Range: 0 ~ 53 characters.</b>
<b>Password</b>	String format : any text	Enter the <b>Password</b> you want to use for the authentication.
<b>Authentication</b>	1. A Must filled setting 2. By default <b>Auto</b> is selected	Select the Authentication method for the 3G/4G connection. It can be <b>Auto</b> , <b>PAP</b> , <b>CHAP</b> , or <b>None</b> .
<b>Priority</b>	1. A Must filled setting 2. String format : integer	Enter the value for the dialing-up order. The valid value is from 1 to 16. It will start to dial up with the profile that assigned with the smallest number. <b>Value Range: 1 ~ 16.</b>
<b>Profile</b>	The box is checked by default	Check the box to enable this profile. Uncheck the box to disable this profile in dialing-up action.
<b>Save</b>	N/A	Click the <b>Save</b> button to save the configuration.
<b>Undo</b>	N/A	Click the <b>X</b> button to restore what you just configured back to the previous setting.

## Setup 3G/4G Connection Common Configuration

Here you can change common configurations for 3G/4G WAN.

3G/4G Connection Common Configuration	
Item	Setting
▶ Connection Control	Auto-reconnect ▼
▶ Time Schedule	(0) Always ▼
▶ MTU Setup	<input type="checkbox"/> Enable
▶ IP Passthrough (Cellular Bridge)	<input type="checkbox"/> Enable Fixed MAC : <input type="text"/>
▶ NAT	<input checked="" type="checkbox"/> Enable
▶ IGMP	Disable ▼
▶ WAN IP Alias	<input type="checkbox"/> Enable <input type="text" value="10.0.0.1"/>

3G/4G Connection Common Configuration		
Item	Value setting	Description
<b>Connection Control</b>	By default <b>Auto-reconnect</b> is selected	When <b>Auto-reconnect</b> is selected, it means it will try to keep the Internet connection on all the time whenever the physical link is connected. When <b>Connect-on-demand</b> is selected, it means the Internet connection will be established only when detecting data traffic. When <b>Connect Manually</b> is selected, it means you need to click the <b>Connect</b> button to dial up the connection manually. Please go to <b>Status &gt;</b>

# 4G LTE M2M Router

		<p><b>Basic Network &gt; WAN &amp; Uplink</b> tab for details.</p> <p><b>Note:</b> If the WAN interface serves as the primary one for another WAN interface in Failover role( and vice versa), the Connection Control parameter will not be available on both WANs as the system must set it to "Auto-reconnect"</p>
<b>Maximum Idle Time</b>	<p>1. An Optional setting 2. By default <b>600</b> seconds is filled-in</p>	<p>Specify the maximum Idle time setting to disconnect the internet connection when the connection idle timed out. <b>Value Range:</b> 300 ~ 86400. <b>Note:</b> This field is available only when <b>Connect-on-demand</b> or <b>Connect Manually</b> is selected as the connection control scheme.</p>
<b>Time Schedule</b>	<p>1. A Must filled setting 2. By default <b>(0) Always</b> is selected</p>	<p>When <b>(0) Always</b> is selected, it means this WAN is under operation all the time. Once you have set other schedule rules, there will be other options to select. Please go to <b>Object Definition &gt; Scheduling</b> for details.</p>
<b>MTU Setup</b>	<p>1. An Optional setting 2. <b>Uncheck</b> by default</p>	<p>Check the Enable box to enable the MTU (Maximum Transmission Unit) limit, and specify the <b>MTU</b> for the 3G/4G connection. <b>MTU</b> refers to Maximum Transmission Unit. It specifies the largest packet size permitted for Internet transmission. <b>Value Range:</b> 1200 ~ 1500.</p>
<b>IP Pass-through (Cellular Bridge)</b>	<p>1. The box is unchecked by default 2. String format for <b>Fixed MAC</b>: MAC address, e.g. 00:50:18:aa:bb:cc</p>	<p>When <b>Enable</b> box is checked, it means the device will directly assign the WAN IP to the first connected local LAN client. However, when an optional <b>Fixed MAC</b> is filled-in a non-zero value, it means only the client with this MAC address can get the WAN IP address. <b>Note:</b> When the <b>IP Pass-through</b> is on, <b>NAT</b> and <b>WAN IP Alias</b> will be unavailable until the function is disabled again.</p>
<b>NAT</b>	<b>Check</b> by default	Uncheck the box to disable <b>NAT</b> (Network Address Translation) function.
<b>IGMP</b>	By default <b>Disable</b> is selected	Select <b>Auto</b> to enable <b>IGMP</b> function. Check the <b>Enable</b> box to enable <b>IGMP Proxy</b> .
<b>WAN IP Alias</b>	<p>1. Unchecked by default 2. String format: IP address (IPv4 type)</p>	Check the box to enable <b>WAN IP Alias</b> , and fill in the IP address you want to assign.

Network Monitoring Configuration	
Item	Setting
▶ Network Monitoring Configuration	<input checked="" type="checkbox"/> Enable
▶ Checking Method	DNS Query ▼
▶ Loading Check	<input checked="" type="checkbox"/> Enable
▶ Query Interval	5 (seconds)
▶ Latency Threshold	3000 (ms)
▶ Fail Threshold	5 (Times)
▶ Target1	DNS1 ▼
▶ Target2	None ▼

# 4G LTE M2M Router

Network Monitoring Configuration		
Item	Value setting	Description
<b>Network Monitoring Configuration</b>	1. An optional setting 2. Box is checked by default	Check the <b>Enable</b> box to activate the network monitoring function.
<b>Checking Method</b>	1. An Optional setting 2. <b>DNS Query</b> is set by default	Choose either <b>DNS Query</b> or <b>ICMP Checking</b> to detect WAN link. With <b>DNS Query</b> , the system checks the connection by sending DNS Query packets to the destination specified in Target 1 and Target 2. With <b>ICMP Checking</b> , the system will check connection by sending ICMP request packets to the destination specified in Target 1 and Target 2.
<b>Loading Check</b>	1. An optional setting 2. Box is checked by default	Check the <b>Enable</b> box to activate the loading check function. Enable Loading Check allows the gateway to ignore unreturned DNS queries or ICMP requests when WAN bandwidth is fully occupied. This is to prevent false link-down status.
<b>Query Interval</b>	1. An Optional setting 2. <b>5 seconds</b> is selected by default.	Specify a time interval as the <b>DNS Query Interval</b> . <b>Query Interval</b> defines the transmitting interval between two DNS Query or ICMP checking packets. With <b>DNS Query</b> , the system checks the connection by sending DNS Query packets to the destination specified in Target 1 and Target 2. <b>Value Range:</b> 2 ~ 14400.
<b>Check Interval</b>	1. An Optional setting 2. <b>5 seconds</b> is selected by default.	Specify a time interval as the <b>ICMP Checking Interval</b> . <b>Query Interval</b> defines the transmitting interval between two DNS Query or ICMP checking packets. With <b>ICMP Checking</b> , the system will check connection by sending ICMP request packets to the destination specified in Target 1 and Target 2. <b>Value Range:</b> 2 ~ 14400.
<b>Latency Threshold</b>	1. An Optional setting 2. <b>3000 ms</b> is set by default	Enter a number of detecting disconnection times to be the threshold before disconnection is acknowledged. <b>Latency Threshold</b> defines the tolerance threshold of responding time. <b>Value Range:</b> 2000 ~ 3000 seconds.
<b>Fail Threshold</b>	1. An Optional setting 2. <b>5 times</b> is set by default	Enter a number of detecting disconnection times to be the threshold before disconnection is acknowledged. <b>Fail Threshold</b> specifies the detected disconnection before the router recognize the WAN link down status. <b>Value Range:</b> 1 ~ 10 times.
<b>Target 1</b>	1. An Optional filled setting 2. <b>DNS1</b> is selected by default	<b>Target1</b> specifies the first target of sending DNS query/ICMP request. <b>DNS1:</b> set the primary DNS to be the target. <b>DNS2:</b> set the secondary DNS to be the target. <b>Gateway:</b> set the Current gateway to be the target. <b>Other Host:</b> enter an IP address to be the target.
<b>Target 2</b>	1. An Optional filled setting 2. <b>None</b> is selected by default	<b>Target1</b> specifies the second target of sending DNS query/ICMP request. <b>None:</b> no second target is required. <b>DNS1:</b> set the primary DNS to be the target. <b>DNS2:</b> set the secondary DNS to be the target. <b>Gateway:</b> set the Current gateway to be the target. <b>Other Host:</b> enter an IP address to be the target.
<b>Save</b>	N/A	Click <b>Save</b> to save the settings.
<b>Undo</b>	N/A	Click <b>Undo</b> to cancel the settings.

# 4G LTE M2M Router

## [Internet Connection – WiFi Uplink WAN](#)

If the device connects to Internet through WiFi Uplink, this section will help you to complete WiFi Uplink connection setup.

Go to **Basic Network > WAN & Uplink > Internet Setup** tab.

WiFi Uplink interface: The Uplink network is a wireless network, and the gateway can connect to the Uplink network through WiFi connection.

If you have the access permission to a certain wireless network, you can setup a WiFi Uplink connection by using the gateway device. This gateway can support 802.11ac/n/g/b data connection, and it can connect to a wireless network (access point) under the regular infrastructure mode.

Internet Connection List				
Interface Name	Physical Interface	Operation Mode	WAN Type	Action
WAN-1	Ethernet	Always on	Static IP	<input type="button" value="Edit"/>
WAN-2	WiFi Module One	Always on	Uplink	<input type="button" value="Edit"/>
WAN-3	-	Disable	-	<input type="button" value="Edit"/>
WAN-4	-	Disable	-	<input type="button" value="Edit"/>

## Configure WiFi Uplink Setting

When **Edit** button is applied, **Internet Connection Configuration** screen will appear. WAN-2 interface is used in this example.

Internet Connection Configuration ( WAN - 2 )	
Item	Setting
▶ WAN Type	<input type="text" value="Uplink"/>

Internet Connection Configuration		
Item	Value setting	Description
WAN Type	<b>1. A Must filled setting.</b> <b>2. Uplink is selected by default.</b>	From the dropdown box, select Internet connection method for WiFi Uplink Connection. Only <b>Uplink</b> is available.

# 4G LTE M2M Router

## WiFi Uplink

WiFi Uplink WAN Type Configuration	
Item	Setting
▶ Connect to AP	Only_For_Monkey-Ch#1-WPA2-PSK (AES) <input type="button" value="Scan"/> <input type="button" value="Edit"/>
▶ Network Type	NAT Mode ▾
▶ IP Mode	Dynamic IP ▾
▶ Host Name	<input type="text"/> (Optional)
▶ Connection Control	Connect Manually ▾
▶ Maximum Idle Time	<input type="text" value="86400"/> (seconds)
▶ Fast Roaming	<input type="checkbox"/> Enable Signal Threshold <input type="text" value="40"/> %
▶ Fast Roaming Channels	<input type="text" value="N/A"/> ▾ <input type="text" value="N/A"/> ▾ <input type="text" value="N/A"/> ▾

WiFi Uplink WAN Type Configuration		
Item	Value setting	Description
<b>Connect to AP</b>	N/A	Display the information of AP for connecting. You can Click the <b>Scan</b> button and select a AP for the uplink network. Besides, you can also create uplink profile(s) for ease of connecting to an available Uplink network. Refer to <b>Basic Network &gt; WiFi &gt; Uplink Profile</b> tab.
<b>Network Type</b>	1. A Must filled setting 2. <b>NAT Mode</b> is selected by default.	Select the expected network type for the WiFi Uplink connection. It can be <b>NAT Mode</b> , <b>Bridge Mode</b> , or <b>NAT Disable</b> . When <b>NAT Mode</b> is selected, the NAT function is activated on the Wireless Uplink connection; When <b>Bridge Mode</b> is selected, the bridge function is activated on the Wireless Uplink connection; The supporting of bridge mode depends on the product specification, if the purchased device doesn't support the bridge mode, it will be greyed out from selection. When <b>NAT Disable</b> is selected, the NAT function is deactivated on the Wireless Uplink connection, and it can function as a router with manually configured routing setting.
<b>IP Mode</b>	1. A Must filled setting 2. <b>Dynamic IP</b> is selected by default.	Specify the IP mode for the wireless uplink Interface. It can be <b>Dynamic IP</b> or <b>Static IP</b> . When <b>Dynamic IP</b> is selected, the device will request a IP from the Uplink Network as the IP for the uplink interface ; When <b>Static IP</b> is selected, you have to manually configure the IP address settings for the uplink interface. The settings include IP address, subnet mask, gateway, and primary/secondary DNS.
<b>Connection Control</b>	A Must filled setting	There are three connection modes. <ul style="list-style-type: none"> <li>• <b>Auto-reconnect (Always on)</b> enables the router to always keep the Internet connection on.</li> <li>• <b>Connect-on-demand</b> enables the router to automatically re-establish Internet connection as soon as user attempts to access the Internet. Internet connection will be disconnected when it has been inactive for a specified idle time.</li> <li>• <b>Connect Manually</b> allows user to connect to Internet manually.</li> </ul>

# 4G LTE M2M Router

		Internet connection will be inactive after it has been inactive for specified idle time.
<b>Maximum Idle Time</b>	1. An Optional setting 2. By default <b>600</b> seconds is filled-in	Specify the maximum Idle time setting to disconnect the internet connection when the connection idle timed out. <b>Value Range:</b> 300 ~ 86400. <b>Note:</b> This field is available only when <b>Connect-on-demand</b> or <b>Connect Manually</b> is selected as the connection control scheme.
<b>Fast Roaming</b>	1. An Optional setting 2. <b>Unchecked</b> is selected by default.	Click the <b>Enable</b> checkbox to activate the fast roaming function. In addition, you can also specify a threshold value for changing from one AP to another near-by AP. The default threshold value is 40%. <b>Value Range:</b> 30 ~ 60%.
<b>Fast Roaming Channels</b>	1. An Optional setting 2. <b>N/A</b> is selected by default.	You can specify up to three channels for WiFi Uplink fast roaming function. If you don't specify any channel, the WiFi uplink will just operate on original connection channel.

## Network Monitoring

Network Monitoring Configuration	
Item	Setting
▶ Network Monitoring Configuration	<input checked="" type="checkbox"/> Enable
▶ Checking Method	DNS Query ▼
▶ Loading Check	<input checked="" type="checkbox"/> Enable
▶ Query Interval	5 (seconds)
▶ Latency Threshold	3000 (ms)
▶ Fail Threshold	5 (Times)
▶ Target1	DNS1 ▼
▶ Target2	None ▼

Network Monitoring Configuration		
Item	Value setting	Description
<b>Network Monitoring Configuration</b>	1. An optional setting 2. Box is checked by default	Check the <b>Enable</b> box to activate the network monitoring function.
<b>Checking Method</b>	1. An Optional setting 2. <b>DNS Query</b> is set by default	Choose either <b>DNS Query</b> or <b>ICMP Checking</b> to detect WAN link. With <b>DNS Query</b> , the system checks the connection by sending DNS Query packets to the destination specified in Target 1 and Target 2. With <b>ICMP Checking</b> , the system will check connection by sending ICMP request packets to the destination specified in Target 1 and Target 2.
<b>Loading Check</b>	1. An optional setting 2. Box is checked by default	Check the <b>Enable</b> box to activate the loading check function. Enable Loading Check allows the gateway to ignore unreturned DNS queries or ICMP requests when WAN bandwidth is fully occupied. This is to prevent false link-down status.
<b>Query Interval</b>	1. An Optional setting	Specify a time interval as the <b>DNS Query Interval</b> .

# 4G LTE M2M Router

	2. <b>5 seconds</b> is selected by default.	<b>Query Interval</b> defines the transmitting interval between two DNS Query or ICMP checking packets. With <b>DNS Query</b> , the system checks the connection by sending DNS Query packets to the destination specified in Target 1 and Target 2. <b>Value Range:</b> 2 ~ 14400.
<b>Check Interval</b>	1. An Optional setting 2. <b>5 seconds</b> is selected by default.	Specify a time interval as the ICMP <b>Checking Interval</b> . <b>Query Interval</b> defines the transmitting interval between two DNS Query or ICMP checking packets. With <b>ICMP Checking</b> , the system will check connection by sending ICMP request packets to the destination specified in Target 1 and Target 2. <b>Value Range:</b> 2 ~ 14400.
<b>Latency Threshold</b>	1. An Optional setting 2. <b>3000 ms</b> is set by default	Enter a number of detecting disconnection times to be the threshold before disconnection is acknowledged. <b>Latency Threshold</b> defines the tolerance threshold of responding time. <b>Value Range:</b> 2000 ~ 3000 seconds.
<b>Fail Threshold</b>	1. An Optional setting 2. <b>5 times</b> is set by default	Enter a number of detecting disconnection times to be the threshold before disconnection is acknowledged. <b>Fail Threshold</b> specifies the detected disconnection before the router recognize the WAN link down status. <b>Value Range:</b> 1 ~ 10 times.
<b>Target 1</b>	1. An Optional filled setting 2. <b>DNS1</b> is selected by default	<b>Target1</b> specifies the first target of sending DNS query/ICMP request. <b>DNS1:</b> set the primary DNS to be the target. <b>DNS2:</b> set the secondary DNS to be the target. <b>Gateway:</b> set the Current gateway to be the target. <b>Other Host:</b> enter an IP address to be the target.
<b>Target 2</b>	1. An Optional filled setting 2. <b>None</b> is selected by default	<b>Target1</b> specifies the second target of sending DNS query/ICMP request. <b>None:</b> no second target is required. <b>DNS1:</b> set the primary DNS to be the target. <b>DNS2:</b> set the secondary DNS to be the target. <b>Gateway:</b> set the Current gateway to be the target. <b>Other Host:</b> enter an IP address to be the target.
<b>Save</b>	N/A	Click <b>Save</b> to save the settings.
<b>Undo</b>	N/A	Click <b>Undo</b> to cancel the settings.

# 4G LTE M2M Router

## 2.2 LAN & VLAN

This section provides the configuration of LAN and VLAN. VLAN is an optional feature, and it depends on the product specification of the purchased gateway.

### 2.2.1 Ethernet LAN

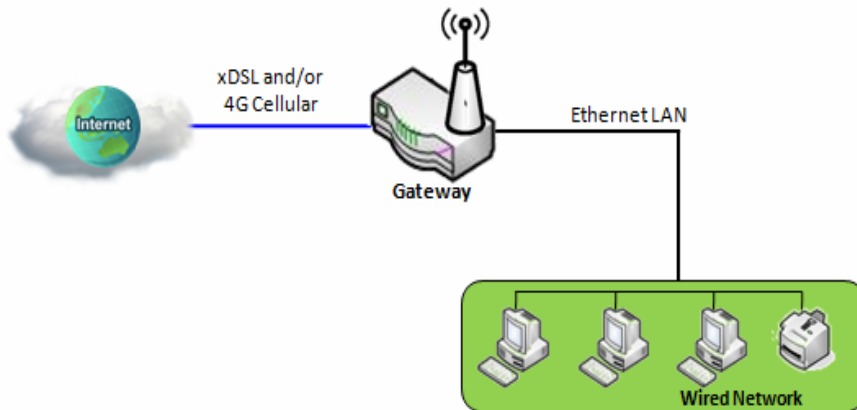

The Local Area Network (LAN) can be used to share data or files among computers attached to a network. Following diagram illustrates the network that wired and interconnects computers.

Please follow the following instructions to do IPv4 Ethernet LAN Setup.

Configuration	
Item	Setting
▶ IP Mode	Static IP
▶ LAN IP Address	<input type="text" value="192.168.0.1"/>
▶ Subnet Mask	<input type="text" value="255.255.255.0 (/24)"/>

Item	Value setting	Description
<b>IP Mode</b>	N/A	It shows the LAN IP mode for the gateway according the related configuration. <b>Static IP:</b> If there is at least one WAN interface activated, the LAN IP mode is fixed in Static IP mode. <b>Dynamic IP:</b> If all the available WAN interfaces are disabled, the LAN IP mode can be Dynamic IP mode.
<b>LAN IP Address</b>	1. A Must filled setting 2. 192.168.0.1 is set by default	Enter the local IP address of this device. The network device(s) on your network must use the LAN IP address of this device as their Default Gateway. You can change it if necessary.  <b>Note:</b> It's also the IP address of web UI. If you change it, you need to type new IP address in the browser to see web UI.
<b>Subnet Mask</b>	1. A Must filled setting 2. 255.255.255.0 (/24) is set	Select the subnet mask for this gateway from the dropdown list. Subnet mask defines how many clients are allowed in one network or subnet.

# 4G LTE M2M Router

	by default	The default subnet mask is 255.255.255.0 (/24), and it means maximum 254 IP addresses are allowed in this subnet. However, one of them is occupied by LAN IP address of this gateway, so there are maximum 253 clients allowed in LAN network. <b>Value Range:</b> 255.0.0.0 (/8) ~ 255.255.255.252 (/30).
<b>Save</b>	N/A	Click the <b>Save</b> button to save the configuration
<b>Undo</b>	N/A	Click the <b>Undo</b> button to restore what you just configured back to the previous setting.

## Create / Edit Additional IP

This gateway provides the LAN IP alias function for some special management consideration. You can add additional LAN IP for this gateway, and access to this gateway with the additional IP.

ID	Name	Interface	IP Address	Subnet Mask	Enable	Action
----	------	-----------	------------	-------------	--------	--------

When **Add** button is applied, **Additional IP Configuration** screen will appear.

Item	Setting
Name	<input type="text"/>
Interface	lo ▼
IP Address	<input type="text"/>
Subnet Mask	255.255.255.0 (/24) ▼
Enable	<input type="checkbox"/>
<input type="button" value="Save"/>	

Configuration		
Item	Value setting	Description
<b>Name</b>	.1 An Optional Setting	Enter the name for the alias IP address.
<b>Interface</b>	1. A Must filled setting 2. <b>lo</b> is set by default	Specify the Interface type. It can be <b>lo</b> or <b>br0</b> .
<b>IP Address</b>	1. An Optional setting 2. <b>192.168.0.1 is set by default</b>	Enter the addition IP address for this device.
<b>Subnet Mask</b>	1. A Must filled setting 2. <b>255.255.255.0 (/24)</b> is set by default	Select the subnet mask for this gateway from the dropdown list. Subnet mask defines how many clients are allowed in one network or subnet. The default subnet mask is 255.255.255.0 (/24), and it means maximum 254 IP addresses are allowed in this subnet. However, one of them is occupied by LAN IP address of this gateway, so there are maximum 253 clients allowed in LAN

# 4G LTE M2M Router

		network. <b><i>Value Range:</i></b> 255.0.0.0 (/8) ~ 255.255.255.255 (/32).
<b>Save</b>	NA	Click the <b>Save</b> button to save the configuration

# 4G LTE M2M Router

## 2.2.2 VLAN

VLAN (Virtual LAN) is a logical network under a certain switch or router device to group client hosts with a specific VLAN ID. This gateway supports both Port-based VLAN and Tag-based VLAN. These functions allow you to divide local network into different “virtual LANs”. It is common requirement for some application scenario. For example, there are various departments within SMB. All client hosts in the same department should own common access privilege and QoS property. You can assign departments either by port-based VLAN or tag-based VLAN as a group, and then configure it by your plan. In some cases, ISP may need router to support “VLAN tag” for certain kinds of services (e.g. IPTV). You can group all devices required this service as one tag-based VLAN.

If the gateway has only one physical Ethernet LAN port, only very limited configuration is available if you enable the Port-based VLAN.

### ➤ Port-based VLAN

Port-based VLAN function can group Ethernet ports, Port-1 ~ Port-4, and WiFi Virtual Access Points, VAP-1 ~ VAP-8, together for differentiated services like Internet surfing, multimedia enjoyment, VoIP talking, and so on. Two operation modes, NAT and Bridge, can be applied to each VLAN group. One DHCP server can be allocated for a NAT VLAN group to let group host member get its IP address. Thus, each host can surf Internet via the NAT mechanism of business access gateway. In bridge mode, Intranet packet flow is delivered out WAN trunk port with VLAN tag to upper link for different services.

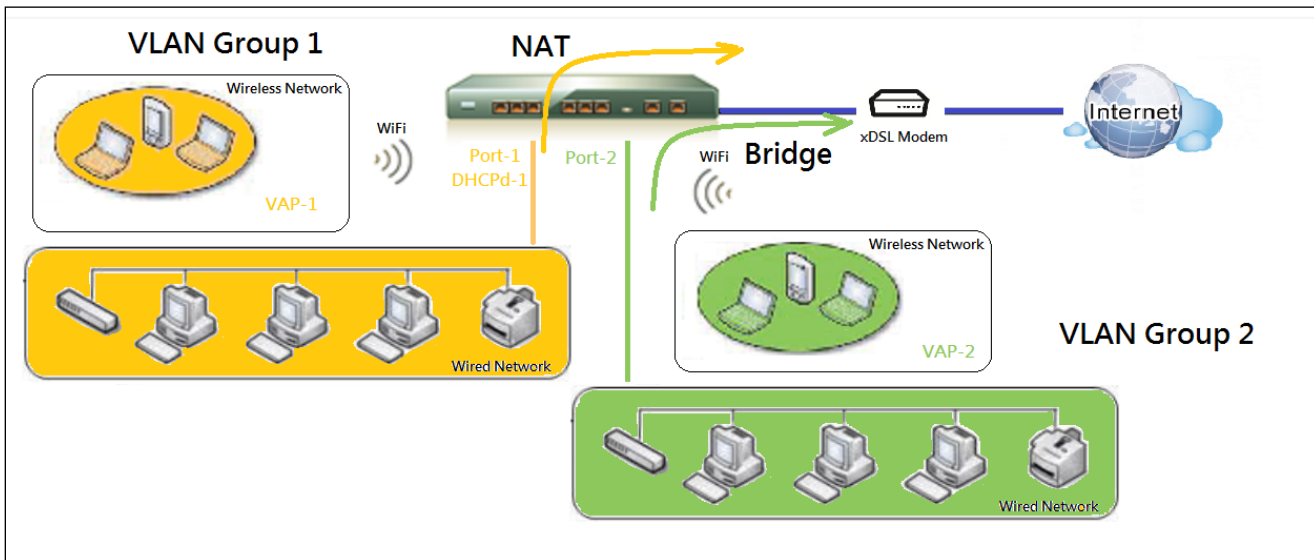

A port-based VLAN is a group of ports on an Ethernet or Virtual APs of Wired or Wireless Gateway that form a logical LAN segment. Following is an example.

For example, in a company, administrator schemes out 3 network segments, Lobby/Meeting Room, Office, and Data Center. In a Wireless Gateway, administrator can configure Lobby/Meeting Room segment with VLAN ID 3. The VLAN group includes Port-3 and VAP-8 (SSID: Guest) with NAT mode and DHCP-3 server equipped. He also configure Office segment with VLAN ID 2. The VLAN group includes Port-2 and VAP-1 (SSID:

# 4G LTE M2M Router

Staff) with NAT mode and DHCP-2 server equipped. At last, administrator also configure Data Center segment with VLAN ID 1. The VLAN group includes Port-1 with NAT mode to WAN interface as shown in following diagram.

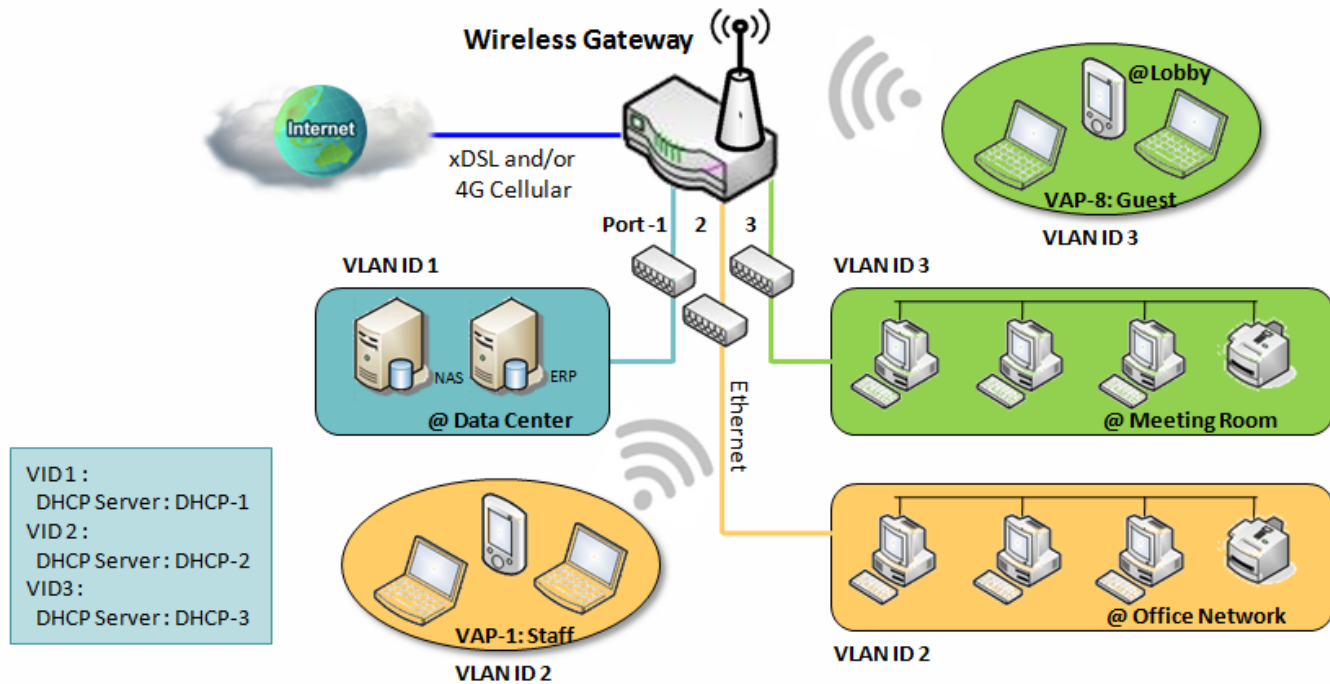

Above is the general case for 3 Ethernet LAN ports in the gateway. But if the device just has one Ethernet LAN port, there will be only one VLAN group for the device. Under such situation, it still supports both the NAT and Bridge mode for the Port-based VLAN configuration.

## ➤ Tag-based VLAN

Tag-based VLAN function can group Ethernet ports, Port-1 ~ Port-4, and WiFi Virtual Access Points, VAP-1 ~ VAP-8, together with different VLAN tags for deploying subnets in Intranet. All packet flows can carry with different VLAN tags even at the same physical Ethernet port for Intranet. These flows can be directed to different destination because they have differentiated tags. The approach is very useful to group some hosts at different geographic location to be in the same workgroup.

Tag-based VLAN is also called a VLAN Trunk. The VLAN Trunk collects all packet flows with different VLAN IDs from Router device and delivers them in the Intranet. VLAN membership in a tagged VLAN is determined by VLAN ID information within the packet frames that are received on a port. Administrator can further use a VLAN switch to separate the VLAN trunk to different groups based on VLAN ID. Following is an example.

# 4G LTE M2M Router

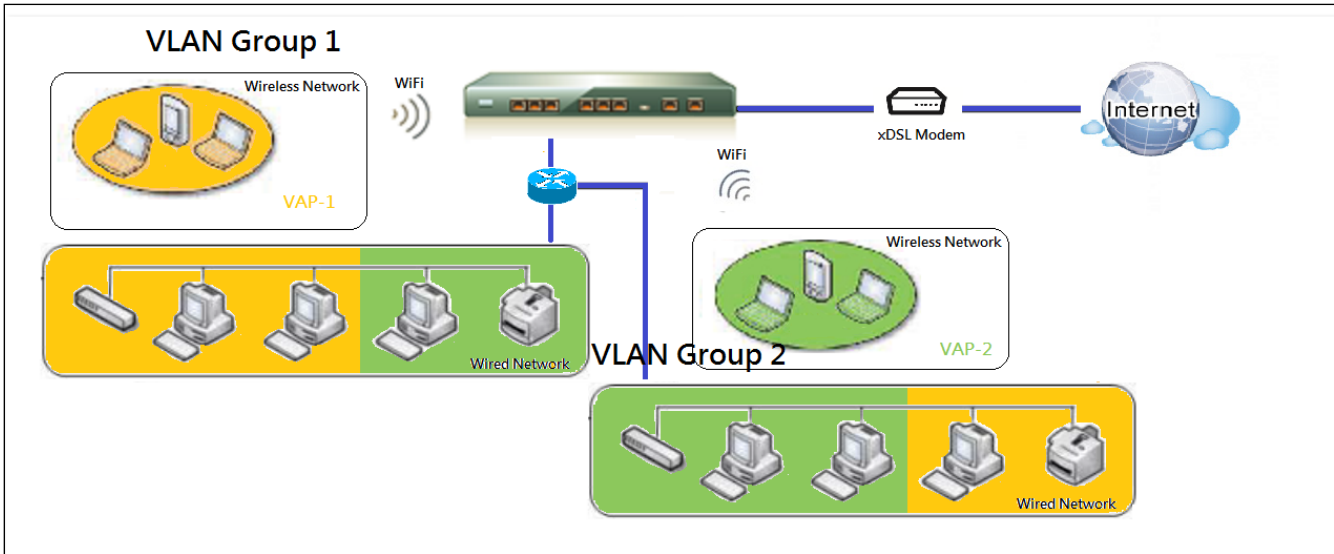

For example, in a company, administrator schemes out 3 network segments, Lab, Meeting Rooms, and Office. In a Security VPN Gateway, administrator can configure Office segment with VLAN ID 12. The VLAN group is equipped with DHCP-3 server to construct a 192.168.12.x subnet. He also configure Meeting Rooms segment with VLAN ID 11. The VLAN group is equipped with DHCP-2 server to construct a 192.168.11.x subnet for Intranet only. That is, any client host in VLAN 11 group can't access the Internet. At last, he configures Lab segment with VLAN ID 10. The VLAN group is equipped with DHCP-1 server to construct a 192.168.10.x subnet.

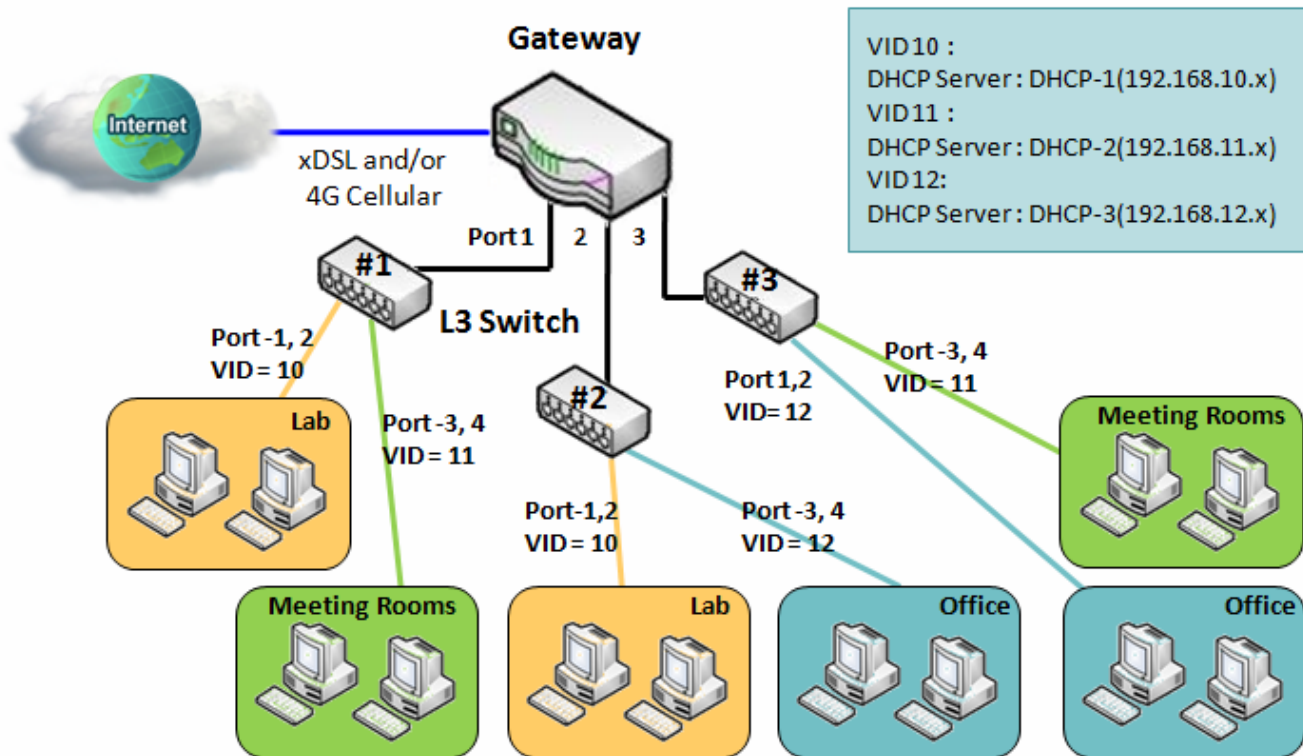

# 4G LTE M2M Router

## ➤ VLAN Groups Access Control

Administrator can specify the Internet access permission for all VLAN groups. He can also configure which VLAN groups are allowed to communicate with each other.

## VLAN Group Internet Access

Administrator can specify members of one VLAN group to be able to access Internet or not. Following is an example that VLAN groups of VID is 2 and 3 can access Internet but the one with VID is 1 cannot access Internet. That is, visitors in meeting room and staffs in office network can access Internet. But the computers/servers in data center cannot access Internet since security consideration. Servers in data center only for trusted staffs or are accessed in secure tunnels.

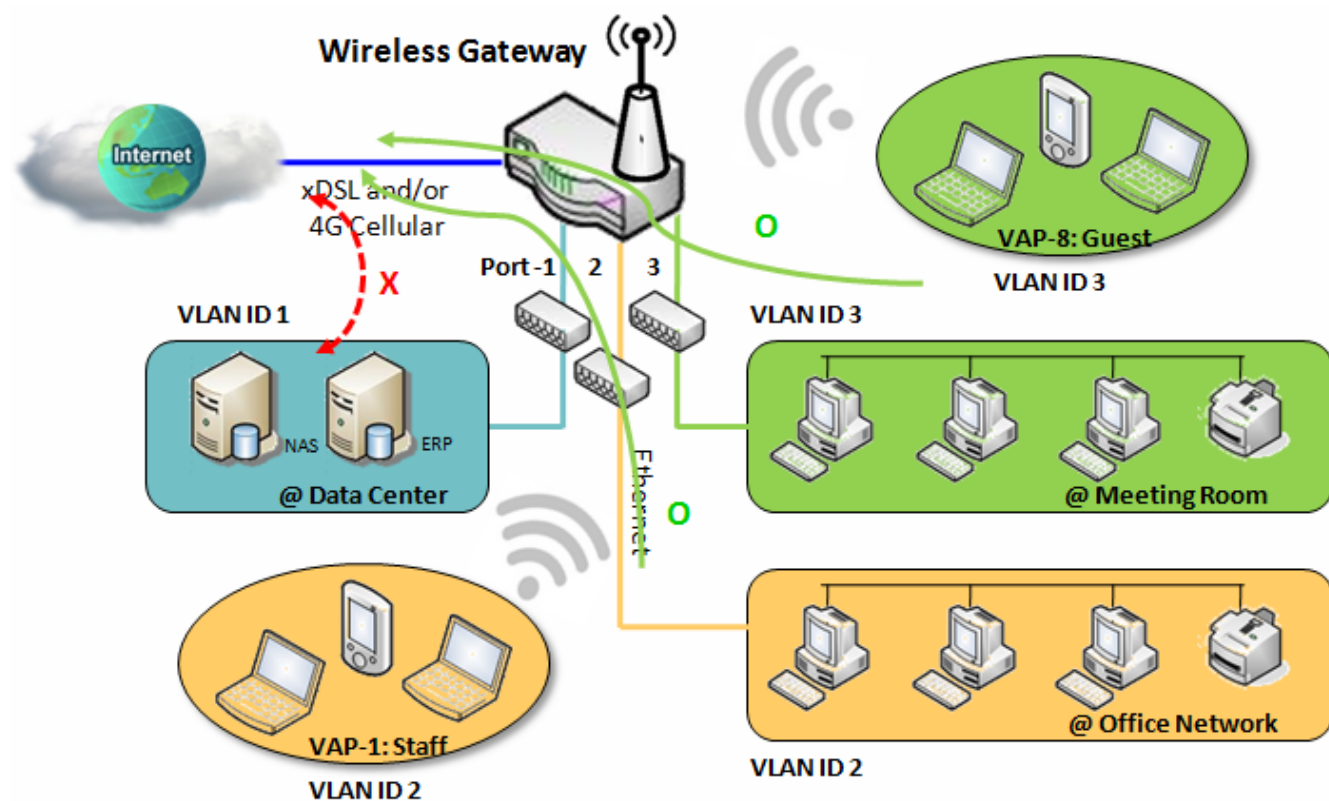

# 4G LTE M2M Router

## Inter VLAN Group Routing:

In Port-based tagging, administrator can specify member hosts of one VLAN group to be able to communicate with the ones of another VLAN group or not. This is a communication pair, and one VLAN group can join many communication pairs. But communication pair doesn't have the transitive property. That is, A can communicate with B, and B can communicate with C, it doesn't imply that A can communicate with C. An example is shown at following diagram. VLAN groups of VID is 1 and 2 can access each other but the ones between VID 1 and VID 3 and between VID 2 and VID 3 can't.

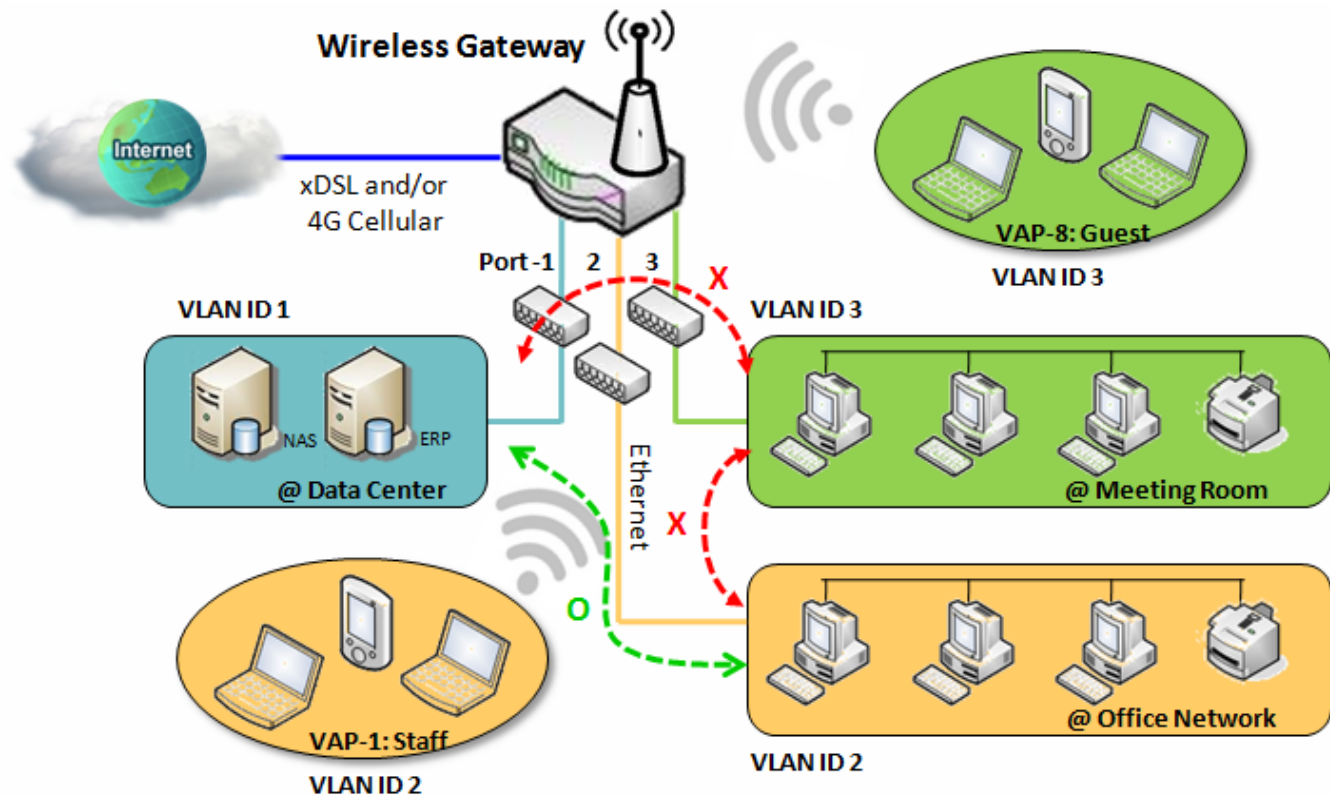

# 4G LTE M2M Router

## VLAN Setting

Go to **Basic Network > LAN & VLAN > VLAN** Tab.

The VLAN function allows you to divide local network into different virtual LANs. There are Port-based and Tag-based VLAN types. Select one that applies.

Configuration	
Item	Setting
VLAN Types	Port-based ▼
System Reserved VLAN ID	Start ID <input type="text" value="1"/> (1-4091) ~ End ID <input type="text" value="5"/>

Configuration		
Item	Value setting	Description
<b>VLAN Type</b>	<b>Port-based</b> is selected by default	Select the VLAN type that you want to adopt for organizing you local subnets. <b>Port-based:</b> Port-based VLAN allows you to add rule for each LAN port, and you can do advanced control with its VLAN ID. <b>Tag-based:</b> Tag-based VLAN allows you to add VLAN ID, and select member and DHCP Server for this VLAN ID. Go to <b>Tag-based VLAN List</b> table.
<b>System Reserved VLAN ID</b>	1 ~ 5 is reserved by default	Specify the VLAN ID range that is reserved for the system operation. For the Port-based/Tag-based VLAN grouping, only use the ID outside the reserved range. <b>Value Range:</b> 1 ~ 4091.
<b>Save</b>	NA	Click the <b>Save</b> button to save the configuration

## Port-based VLAN – Create/Edit VLAN Rules

The port-based VLAN allows you to custom each LAN port. There is a default rule shows the configuration of all LAN ports. Also, if your device has a DMZ port, you will see DMZ configuration, too. The maxima rule numbers is based on LAN port numbers.

Port-based VLAN List										
Name	VLAN ID	VLAN Tagging	NAT / Bridge	Port Members	LAN IP Address	Subnet Mask	Joined WAN	WAN VID	Enable	Actions
DMZ	4094	X	NAT	DMZ Port	192.168.6.254	255.255.255.0	WAN - 1	0	<input checked="" type="checkbox"/>	<input type="button" value="Edit"/>
LAN	Native VLAN	X	NAT	<input type="button" value="Detail"/>	192.168.123.254	255.255.255.0	All WANs	0	<input checked="" type="checkbox"/>	<input type="button" value="Edit"/>

When **Add** button is applied, Port-based VLAN Configuration screen will appear, which is including 3 sections: **Port-based VLAN Configuration**, **IP Fixed Mapping Rule List**, and **Inter VLAN Group Routing** (enter through a button)

# 4G LTE M2M Router

## Port-based VLAN - Configuration

Port-based VLAN Configuration	
Item	Setting
▶ Name	VLAN - 1
▶ VLAN ID	<input type="text"/>
▶ VLAN Tagging	Disable ▾
▶ NAT / Bridge	NAT ▾
▶ Port Members	Port: <input type="checkbox"/> Port-2 <input type="checkbox"/> Port-3 2.4G: <input type="checkbox"/> VAP-1 <input type="checkbox"/> VAP-2 <input type="checkbox"/> VAP-3 <input type="checkbox"/> VAP-4 <input type="checkbox"/> VAP-5 <input type="checkbox"/> VAP-6 <input type="checkbox"/> VAP-7 <input type="checkbox"/> VAP-8 5G: <input type="checkbox"/> VAP-1 <input type="checkbox"/> VAP-2 <input type="checkbox"/> VAP-3 <input type="checkbox"/> VAP-4 <input type="checkbox"/> VAP-5 <input type="checkbox"/> VAP-6 <input type="checkbox"/> VAP-7 <input type="checkbox"/> VAP-8
▶ LAN to Join	<input type="checkbox"/> Enable <input type="text" value="DHCP 1"/> ▾

Port-based VLAN Configuration (part-I)		
Item	Value setting	Description
<b>Name</b>	1. A Must filled setting 2. String format: already have default texts	Define the <b>Name</b> of this rule. It has a default text and cannot be modified.
<b>VLAN ID</b>	A Must filled setting	Define the VLAN ID number, range is 1~4094.
<b>VLAN Tagging</b>	<b>Disable</b> is selected by default.	The rule is activated according to <b>VLAN ID</b> and <b>Port Members</b> configuration when <b>Enable</b> is selected.  The rule is activated according <b>Port Members</b> configuration when <b>Disable</b> is selected.
<b>NAT / Bridge</b>	<b>NAT</b> is selected by default.	Select <b>NAT</b> mode or <b>Bridge</b> mode for the rule.
<b>Port Members</b>	These boxes are unchecked by default.	Select which LAN port(s) and VAP(s) that you want to add to the rule. Note: The available member list can be different for the purchased product.
<b>LAN to Join</b>	The box is unchecked by default.	Check the Enable box and select one of the defined DHCP Server for the List to define the DHCP server for the VLAN group. If you enabled this function, all the rest settings will be greyed out, not required to configured manually.
<b>Save</b>	NA	Click the <b>Save</b> button to save the configuration
<b>Undo</b>	NA	Click the <b>Undo</b> button to restore what you just configured back to the previous setting.

If you didn't decide to bind the VLAN group to a pre-defined DHCP server, you have to further specify the following settings.

# 4G LTE M2M Router

▶ WAN & WAN VID to Join	All WANs ▾ <input type="button" value="None"/>
▶ LAN IP Address	<input type="text" value="192.168.2.254"/>
▶ Subnet Mask	<input type="text" value="255.255.255.0 (/24)"/> ▾
▶ DHCP Server / Relay	Server ▾
▶ DHCP Server Name	<input type="text"/>
▶ IP Pool	Starting Address: <input type="text" value="192.168.2.100"/> Ending Address: <input type="text" value="192.168.2.200"/>
▶ Lease Time	<input type="text" value="86400"/> seconds
▶ Domain Name	<input type="text"/> (Optional)
▶ Primary DNS	<input type="text"/> (Optional)
▶ Secondary DNS	<input type="text"/> (Optional)
▶ Primary WINS	<input type="text"/> (Optional)
▶ Secondary WINS	<input type="text"/> (Optional)
▶ Gateway	<input type="text"/> (Optional)
▶ Enable	<input type="checkbox"/>

Port-based VLAN Configuration (part-II)		
Item	Value setting	Description
<b>WAN &amp; WAN VID to Join</b>	All WANs is selected by default.	Select which <b>WAN</b> or <b>All WANs</b> that allow accessing Internet. Note: If Bridge mode is selected, you need to select a WAN and enter a VID.
<b>LAN IP Address</b>	A Must filled setting	Assign an <b>IP Address</b> for the DHCP Server that the rule used, this IP address is a gateway IP.
<b>Subnet Mask</b>	<b>255.255.255.0(/24)</b> is selected by default.	Select a <b>Subnet Mask</b> for the DHCP Server.
<b>DHCP Server /Relay</b>	<b>Server</b> is selected by default.	Define the <b>DHCP Server</b> type. There are three types you can select: <b>Server</b> , <b>Relay</b> , and <b>Disable</b> . <b>Relay</b> : Select <b>Relay</b> to enable DHCP Relay function for the VLAN group, and you only need to fill the <b>DHCP Server IP Address</b> field. <b>Server</b> : Select <b>Server</b> to enable DHCP Server function for the VLAN group, and you need to specify the DHCP Server settings. <b>Disable</b> : Select <b>Disable</b> to disable the DHCP Server function for the VLAN group.
<b>DHCP Server IP Address (for DHCP Relay only)</b>	A Must filled setting	If you select <b>Relay</b> type of DHCP Server, assign a <b>DHCP Server IP Address</b> that the gateway will relay the DHCP requests to the assigned DHCP server.
<b>DHCP Option 82 (for DHCP Relay only)</b>	An Optional filled setting	If you select <b>Relay</b> type of DHCP Server, you can further enable the DHCP Option 82 setting if the DHCP server support it.
<b>DHCP Server Name</b>	A Must filled setting	Define name of the DHCP Server for the specified VLAN group.
<b>IP Pool</b>	A Must filled setting	Define the IP Pool range. There are <b>Starting Address</b> and <b>Ending Address</b> fields. If a client requests an IP address from this DHCP Server, it will assign an IP address in the range of <b>IP pool</b> .

# 4G LTE M2M Router

<b>Lease Time</b>	A Must filled setting	Define a period of time for an IP Address that the DHCP Server leases to a new device. By default, the <b>lease time</b> is 86400 seconds.
<b>Domain Name</b>	String format can be any text	The Domain Name of this DHCP Server. <b>Value Range:</b> 0 ~ 31 characters.
<b>Primary DNS</b>	IPv4 format	The Primary DNS of this DHCP Server.
<b>Secondary DNS</b>	IPv4 format	The Secondary DNS of this DHCP Server.
<b>Primary WINS</b>	IPv4 format	The Primary WINS of this DHCP Server.
<b>Secondary WINS</b>	IPv4 format	The Secondary WINS of this DHCP Server.
<b>Gateway</b>	IPv4 format	The Gateway of this DHCP Server.
<b>Enable</b>	The box is unchecked by default.	Click <b>Enable</b> box to activate this rule.
<b>Save</b>	NA	Click the <b>Save</b> button to save the configuration
<b>Undo</b>	NA	Click the <b>Undo</b> button to restore what you just configured back to the previous setting.

# 4G LTE M2M Router

Besides, you can add some IP rules in the **IP Fixed Mapping Rule List** if DHCP Server for the VLAN groups is required.

IP Fixed Mapping Rule List <span>Add</span> <span>Delete</span>			
MAC Address	IP Address	Enable	Actions

When **Add** button is applied, **Mapping Rule Configuration** screen will appear.

Mapping Rule Configuration		
Item	Value setting	Description
<b>MAC Address</b>	A Must filled setting	Define the <b>MAC Address</b> target that the DHCP Server wants to match.
<b>IP Address</b>	A Must filled setting	Define the <b>IP Address</b> that the DHCP Server will assign. If there is a request from the MAC Address filled in the above field, the DHCP Server will assign this <b>IP Address</b> to the client whose <b>MAC Address</b> matched the rule.
<b>Enable</b>	The box is unchecked by default.	Click <b>Enable</b> box to activate this rule.
<b>Save</b>	NA	Click the <b>Save</b> button to save the configuration

Note: ensure to always click on **Apply** button to apply the changes after the web browser refreshed taken you back to the VLAN page.

Port-based VLAN List <span>Add</span> <span>Delete</span>										
Name	VLAN ID	VLAN Tagging	NAT / Bridge	Port Members	LAN IP Address	Subnet Mask	Joined WAN	WAN VID	Enable	Actions
LAN	Native VLAN Tag 1	X	NAT	<span>Detail</span>	192.168.66.1	255.255.254.0	All WANs	0	<input checked="" type="checkbox"/>	<span>Edit</span>

Apply Inter VLAN Group Routing

# 4G LTE M2M Router

## Port-based VLAN – Inter VLAN Group Routing

Click **VLAN Group Routing** button, the **VLAN Group Internet Access Definition** and **Inter VLAN Group Routing** screen will appear.

VLAN Group Internet Access Definition		
VLAN IDs	Members	Internet Access(WAN)
1	Port : 2,3 2.4G VAP: 1,2,3,4,5,6,7,8 5G VAP: 1,2,3,4,5,6,7,8	Allow <input type="button" value="Edit"/>

Inter VLAN Group Routing		
VLAN IDs	Members	Action
		<input type="button" value="Edit"/>
		<input type="button" value="Edit"/>
		<input type="button" value="Edit"/>
		<input type="button" value="Edit"/>

When **Edit** button is applied, a screen similar to this will appear.

VLAN Group Internet Access Definition		
VLAN IDs	Members	Internet Access(WAN)
<input checked="" type="checkbox"/> 1	Port : 2,3 2.4G VAP: 1,2,3,4,5,6,7,8 5G VAP: 1,2,3,4,5,6,7,8	Allow <input type="button" value="Edit"/>

Inter VLAN Group Routing		
VLAN IDs	Members	Action
<input type="checkbox"/> 1		<input type="button" value="Edit"/>
		<input type="button" value="Edit"/>
		<input type="button" value="Edit"/>
		<input type="button" value="Edit"/>

Inter VLAN Group Routing		
Item	Value setting	Description
<b>VALN Group Internet Access Definition</b>	All boxes are checked by default.	By default, all boxes are checked means all <b>VLAN ID</b> members are allow to access WAN interface. If uncheck a certain <b>VLAN ID</b> box, it means the VLAN ID member can't access Internet anymore.

# 4G LTE M2M Router

		Note: <b>VLAN ID 1</b> is available always; it is the default VLAN ID of <b>LAN</b> rule. The other <b>VLAN IDs</b> are available only when they are enabled.
<b>Inter VLAN Group Routing</b>	The box is unchecked by default.	Click the expected VLAN IDs box to enable the Inter VLAN access function. By default, members in different VLAN IDs can't access each other. The gateway supports up to 4 rules for <b>Inter VLAN Group Routing</b> . For example, if ID_1 and ID_2 are checked, it means members in VLAN ID_1 can access members of VLAN ID_2, and vice versa.
<b>Save</b>	N/A	Click the <b>Save</b> button to save the configuration

## Tag-based VLAN – Create/Edit VLAN Rules

The **Tag-based VLAN** allows you to customize each LAN port according to VLAN ID. There is a default rule shows the configuration of all LAN ports and all VAPs. Also, if your device has a DMZ port, you will see DMZ configuration, too. The router supports up to a maximum of 128 tag-based VLAN rule sets.

VLAN ID	Internet	Port Members	Bridge Interface	IP Address	Subnet Mask	Actions
Native VLAN	<input checked="" type="checkbox"/>	Port: <input checked="" type="checkbox"/> Port-2 <input checked="" type="checkbox"/> Port-3 2.4G: <input checked="" type="checkbox"/> VAP-1 <input checked="" type="checkbox"/> VAP-2 <input checked="" type="checkbox"/> VAP-3 <input checked="" type="checkbox"/> VAP-4 <input checked="" type="checkbox"/> VAP-5 <input checked="" type="checkbox"/> VAP-6 <input checked="" type="checkbox"/> VAP-7 <input checked="" type="checkbox"/> VAP-8 5G: <input checked="" type="checkbox"/> VAP-1 <input checked="" type="checkbox"/> VAP-2 <input checked="" type="checkbox"/> VAP-3 <input checked="" type="checkbox"/> VAP-4 <input checked="" type="checkbox"/> VAP-5 <input checked="" type="checkbox"/> VAP-6 <input checked="" type="checkbox"/> VAP-7 <input checked="" type="checkbox"/> VAP-8	DHCP 1			Edit Select

When **Add** button is applied, **Tag-based VLAN Configuration** screen will appear.

Item	Setting
VLAN ID	0
Internet Access	<input checked="" type="checkbox"/> Enable
Port Members	Port: <input type="checkbox"/> Port-2 <input type="checkbox"/> Port-3 2.4G: <input type="checkbox"/> VAP-1 <input type="checkbox"/> VAP-2 <input type="checkbox"/> VAP-3 <input type="checkbox"/> VAP-4 <input type="checkbox"/> VAP-5 <input type="checkbox"/> VAP-6 <input type="checkbox"/> VAP-7 <input type="checkbox"/> VAP-8 5G: <input type="checkbox"/> VAP-1 <input type="checkbox"/> VAP-2 <input type="checkbox"/> VAP-3 <input type="checkbox"/> VAP-4 <input type="checkbox"/> VAP-5 <input type="checkbox"/> VAP-6 <input type="checkbox"/> VAP-7 <input type="checkbox"/> VAP-8
Bridge Interface	DHCP 1

### Tag-based VLAN Configuration (Part-I)

Item	Value setting	Description
<b>VALN ID</b>	A Must filled setting	Define the <b>VLAN ID</b> number, that is outside the system reserved range. <b>Value Range:</b> 1 ~ 4095.
<b>Internet Access</b>	The box is checked by default.	Click <b>Enable</b> box to allow the members in the VLAN group access to internet.
<b>Port Members</b>	The boxes are unchecked by default.	Check the LAN port box(es) to join the VLAN group. Check the VAP box(es) to join the VLAN group. Note: Only the wireless gateway has the VAP list.
<b>Bridge Interface</b>	<b>DHCP 1</b> is selected by default.	Select a predefined <b>DHCP Server</b> , a <b>New</b> to defined a new DHCP server for these members of this VLAN group.
<b>Save</b>	N/A	Click <b>Save</b> button to save the configuration Note: After clicking <b>Save</b> button, always click <b>Apply</b> button to apply the settings.

# 4G LTE M2M Router

If you select New to create a new DHCP server setting for the VLAN group, you have to further specify the following configuration.

▶ IP Address	<input type="text"/>
▶ Subnet Mask	255.255.255.0 (/24) ▼
▶ DHCP Relay	<input type="checkbox"/> Enable & Server IP : <input type="text"/>
▶ WAN Interface	WAN - 1 ▼
▶ DHCP Relay Option 82	<input type="checkbox"/> Enable

Tag-based VLAN Configuration (part-II)		
Item	Value setting	Description
<b>IP Address</b>	A Must filled setting	Assign an <b>IP Address</b> for the DHCP Server that the rule used, this IP address is a gateway IP.
<b>Subnet Mask</b>	<b>255.255.255.0(/24)</b> is selected by default.	Select a <b>Subnet Mask</b> for the DHCP Server.
<b>DHCP Relay</b>	The box is unchecked by default.	Check the box to enable the DHCP Relay function for the VLAN group, and you only need to fill the <b>DHCP Server IP Address</b> field.
<b>WAN Interface</b>	<b>WAN-1</b> is selected by default.	Select which <b>WAN</b> interface that allow accessing Internet.
<b>DHCP Option 82</b>	An Optional filled setting	If you select <b>Relay</b> type of DHCP Server, you can further enable the DHCP Option 82 setting if the DHCP server support it.
<b>Save</b>	NA	Click the <b>Save</b> button to save the configuration
<b>Undo</b>	NA	Click the <b>Undo</b> button to restore what you just configured back to the previous setting.

## Tag-based VLAN Summary

The configured tag-based VLAN group information will be displayed in the following screen.

Tag-based VLAN Summary	
Port	VLAN IDs
Port2	Native VLAN
Port3	Native VLAN

# 4G LTE M2M Router

## 2.2.3 DHCP Server

### ➤ DHCP Server

The gateway supports up to 4 DHCP servers to fulfill the DHCP requests from different VLAN groups (please refer to VLAN section for getting more usage details). And there is one default setting for whose LAN IP Address is the same one of gateway LAN interface, with its default Subnet Mask setting as “255.255.255.0”, and its default IP Pool ranges is from “.100” to “.200” as shown at the DHCP Server List page on gateway’s WEB UI.

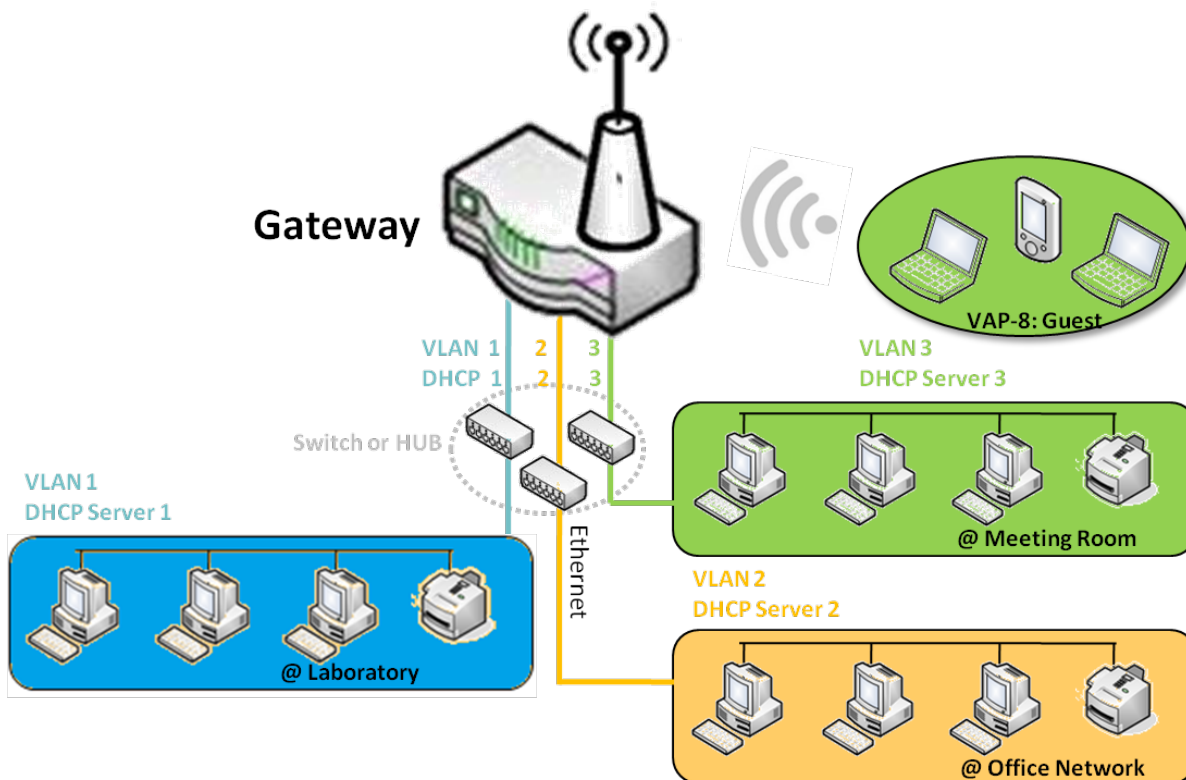

User can add more DHCP server configurations by clicking on the “Add” button behind “DHCP Server List”, or clicking on the “Edit” button at the end of each DHCP Server on list to edit its current settings. Besides, user can select a DHCP Server and delete it by clicking on the “Select” check-box and the “Delete” button.

# 4G LTE M2M Router

## ➤ Fixed Mapping

User can assign fixed IP address to map the specific client MAC address by select them then copy, when targets were already existed in the *DHCP Client List*, or to add some other Mapping Rules by manually in advance, once the target's MAC address was not ready to connect.

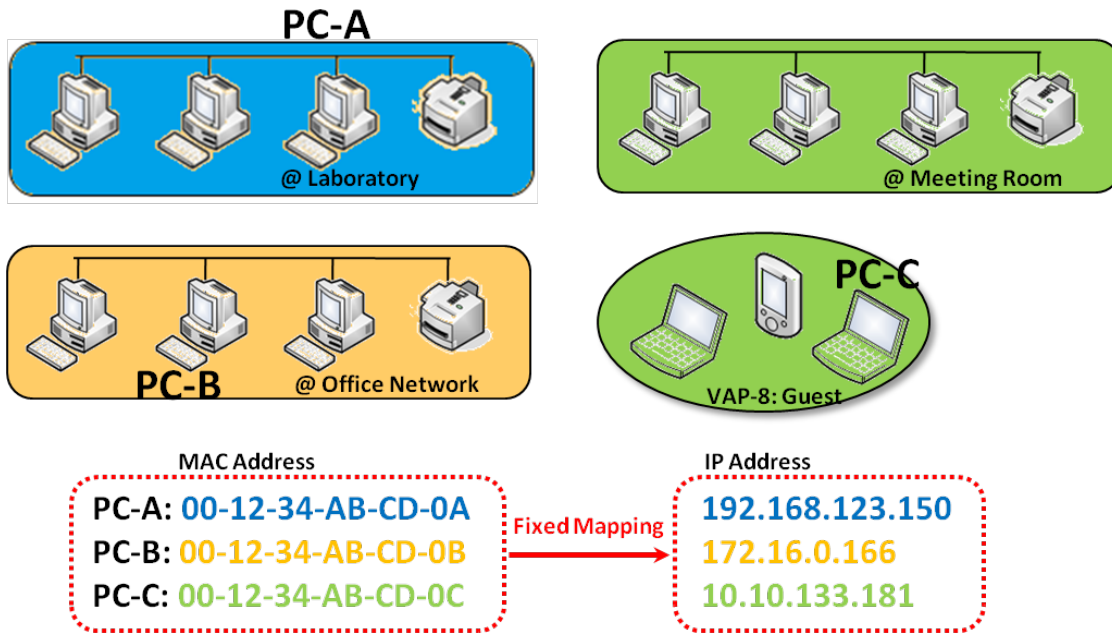

# 4G LTE M2M Router

## DHCP Server Setting

Go to **Basic Network > LAN & VLAN > DHCP Server** Tab.

The DHCP Server setting allows user to create and customize DHCP Server policies to assign IP Addresses to the devices on the local area network (LAN).

### Create / Edit DHCP Server Policy

The gateway allows you to custom your DHCP Server Policy. If multiple LAN ports are available, you can define one policy for each LAN (or VLAN group), and it supports up to a maximum of 4 policy sets.

DHCP Server List												
DHCP Server Name	LAN IP Address	Subnet Mask	IP Pool	Lease Time	Domain Name	Primary DNS	Secondary DNS	Primary WINS	Secondary WINS	Gateway	Enable	Actions
DHCP 1	192.168.66.1	255.255.254.0	192.168.66.100-192.168.66.200	900		0.0.0.0	0.0.0.0	0.0.0.0	0.0.0.0	0.0.0.0	<input checked="" type="checkbox"/>	Edit Fixed Mapping

When **Add** button is applied, **DHCP Server Configuration** screen will appear.

DHCP Server Configuration	
Item	Setting
DHCP Server Name	<input type="text" value="DHCP 2"/>
LAN IP Address	<input type="text" value="192.168.2.1"/>
Subnet Mask	<input type="text" value="255.255.255.0 (/24)"/>
IP Pool	Starting Address: <input type="text"/> Ending Address: <input type="text"/>
Lease Time	<input type="text" value="86400"/> seconds
Domain Name	<input type="text"/> (Optional)
Primary DNS	<input type="text"/> (Optional)
Secondary DNS	<input type="text"/> (Optional)
Primary WINS	<input type="text"/> (Optional)
Secondary WINS	<input type="text"/> (Optional)
Gateway	<input type="text"/> (Optional)

# 4G LTE M2M Router

DHCP Server Configuration		
Item	Value setting	Description
<b>DHCP Server Name</b>	1. String format can be any text 2. A Must filled setting	Enter a DHCP Server name. Enter a name that is easy for you to understand.
<b>LAN IP Address</b>	1. IPv4 format. 2. A Must filled setting	The LAN IP Address of this DHCP Server.
<b>Subnet Mask</b>	255.0.0.0 (/8) is set by default	The Subnet Mask of this DHCP Server.
<b>IP Pool</b>	1. IPv4 format. 2. A Must filled setting	The IP Pool of this DHCP Server. It composed of Starting Address entered in this field and Ending Address entered in this field.
<b>Lease Time</b>	1. Numeric string format. 2. A Must filled setting	The Lease Time of this DHCP Server. <b>Value Range: 300 ~ 604800 seconds.</b>
<b>Domain Name</b>	String format can be any text	The Domain Name of this DHCP Server.
<b>Primary DNS</b>	IPv4 format	The Primary DNS of this DHCP Server.
<b>Secondary DNS</b>	IPv4 format	The Secondary DNS of this DHCP Server.
<b>Primary WINS</b>	IPv4 format	The Primary WINS of this DHCP Server.
<b>Secondary WINS</b>	IPv4 format	The Secondary WINS of this DHCP Server.
<b>Gateway</b>	IPv4 format	The Gateway of this DHCP Server.
<b>Server</b>	The box is unchecked by default.	Click <b>Enable</b> box to activate this DHCP Server.
<b>Save</b>	N/A	Click the <b>Save</b> button to save the configuration
<b>Undo</b>	N/A	Click the <b>Undo</b> button to restore what you just configured back to the previous setting.
<b>Back</b>	N/A	When the <b>Back</b> button is clicked the screen will return to the DHCP Server Configuration page.

## Create / Edit Mapping Rule List on DHCP Server

The gateway allows you to custom your Mapping Rule List on DHCP Server. It supports up to a maximum of 64 rule sets. When **Fix Mapping** button is applied, the **Mapping Rule List** screen will appear.

Mapping Rule List <span>Add</span> <span>Delete</span> <span>↑</span> <span>×</span>			
MAC Address	IP Address	Enable	Actions

When **Add** button is applied, **Mapping Rule Configuration** screen will appear.

# 4G LTE M2M Router

Mapping Rule Configuration	
Item	Setting
▶ MAC Address	<input type="text"/>
▶ IP Address	<input type="text"/>
▶ Rule	<input type="checkbox"/> Enable

Mapping Rule Configuration		
Item	Value setting	Description
<b>MAC Address</b>	1. MAC Address string format 2. A Must filled setting	The MAC Address of this mapping rule.
<b>IP Address</b>	1. IPv4 format. 2. A Must filled setting	The IP Address of this mapping rule.
<b>Rule</b>	The box is unchecked by default.	Click <b>Enable</b> box to activate this rule.
<b>Save</b>	N/A	Click the <b>Save</b> button to save the configuration
<b>Undo</b>	N/A	Click the <b>Undo</b> button to restore what you just configured back to the previous setting.
<b>Back</b>	N/A	When the <b>Back</b> button is clicked the screen will return to the <b>DHCP Server Configuration</b> page.

## View / Copy DHCP Client List

When **DHCP Client List** button is applied, **DHCP Client List** screen will appear.

DHCP Client List <span>Copy to Fixed Mapping</span>					
LAN Interface	IP Address	Host Name	MAC Address	Remaining Lease Time	Actions
Ethernet	Dynamic /192.168.123.100	James-P45V	74:D0:2B:62:8D:42	00:49:07	<input type="checkbox"/> Select

DHCP Client List <span>Copy to Fixed Mapping</span>					
LAN Interface	IP Address	Host Name	MAC Address	Remaining Lease Time	Actions

When the DHCP Client is selected and **Copy to Fixed Mapping** button is applied. The IP and MAC address of DHCP Client will apply to the Mapping Rule List on specific DHCP Server automatically.

## Enable / Disable DHCP Server Options

The **DHCP Server Options** setting allows user to set **DHCP OPTIONS 66, 72, or 114**. Click the **Enable** button to activate the DHCP option packages function, and the DHCP Server will add the expected options in its sending out DHCPOFFER DHCPACK packages.

# 4G LTE M2M Router

Option	Meaning	RFC
66	TFTP server name	<a href="#">[RFC 2132]</a>
72	Default World Wide Web Server	<a href="#">[RFC 2132]</a>
114	URL	<a href="#">[RFC 3679]</a>

▲ ✕

Item	Setting
▶ DHCP Server Options	<input type="checkbox"/> Enable

## Create / Edit DHCP Server Options

The gateway supports up to a maximum of 99 option settings.

▲ ✕

ID	Option Name	DHCP Server Select	Option Select	Type	Value	Enable	Actions
<span>Add</span> <span>Delete</span>							

When **Add/Edit** button is applied, **DHCP Server Option Configuration** screen will appear.

▲ ✕

Item	Setting
▶ Option Name	<input type="text" value="Option 1"/>
▶ DHCP Server Select	<input type="text" value="DHCP 1 ▼"/>
▶ Option Select	<input type="text" value="DHCP OPTION 66 ▼"/>
▶ Type	<input type="text" value="Single IP Address ▼"/>
▶ Value	<input type="text"/>
▶ Enable	<input type="checkbox"/> Enable

DHCP Server Option Configuration		
Item	Value setting	Description
<b>Option Name</b>	1. String format can be any text 2. A Must filled setting.	Enter a DHCP Server Option name. Enter a name that is easy for you to understand.
<b>DHCP Server Select</b>	Dropdown list of all available DHCP servers.	Choose the DHCP server this option should apply to.
<b>Option Select</b>	1. A Must filled setting. 2. <b>Option 66</b> is selected by default.	Choose the specific option from the dropdown list. It can be <b>Option 66, Option 72, Option 144, Option 42, Option 150, or Option 160. Option 42</b> for ntp server;

# 4G LTE M2M Router

		<b>Option 66</b> for tftp; <b>Option 72</b> for www; <b>Option 144</b> for url;		
<b>Type</b>	Dropdown list of DHCP server option value's type	Each different options has different value types.		
		66	Single IP Address Single FQDN	
		72	IP Addresses List, separated by “,”	
		114	Single URL	
		42	IP Addresses List, separated by “,”	
		150	IP Addresses List, separated by “,”	
		160	Single IP Address Single FQDN	
<b>Value</b>	1. IPv4 format 2. FQDN format 3. IP list 4. URL format 5. A Must filled setting	Should conform to Type :		
			Type	Value
		66	Single IP Address	IPv4 format
			Single FQDN	FQDN format
		72	IP Addresses List, separated by “,”	IPv4 format, separated by “,”
114	Single URL	URL format		
<b>Enable</b>	The box is unchecked by default.	Click <b>Enable</b> box to activate this setting.		
<b>Save</b>	NA	Click the <b>Save</b> button to save the setting.		
<b>Undo</b>	NA	When the <b>Undo</b> button is clicked the screen will return back with nothing changed.		

## Create / Edit DHCP Relay

The gateway supports up to a maximum of 6 DHCP Relay configurations.

DHCP Relay Configuration List <span>Add</span> <span>Delete</span>							
ID	Agent Name	LAN interface	WAN interface	Server IP	DHCP Relay Option 82	Enable	Actions

When **Add/Edit** button is applied, **DHCP Relay Configuration** screen will appear.

# 4G LTE M2M Router

DHCP Relay Configuration	
Item	Setting
▶ Agent Name	<input type="text"/>
▶ LAN interface	LAN ▾
▶ WAN interface	WAN - 1 ▾
▶ Server IP	<input type="text"/>
▶ DHCP OPTION 82	<input type="checkbox"/>
▶ Enable	<input type="checkbox"/>

DHCP Relay Configuration		
Item	Value setting	Description
<b>Agent Name</b>	<ol style="list-style-type: none"> <li>String format can be any text</li> <li>A Must filled setting.</li> </ol>	Enter a DHCP Relay name. Enter a name that is easy for you to understand. <b>Value Range:</b> 1~64 characters.
<b>LAN Interface</b>	<ol style="list-style-type: none"> <li>A Must filled setting.</li> <li>LAN is selected by default.</li> </ol>	Choose a LAN Interface for the dropdown list to apply with the DHCP Relay function.
<b>WAN Interface</b>	<ol style="list-style-type: none"> <li>A Must filled setting.</li> <li>WAN-1 is selected by default.</li> </ol>	Choose a WAN Interface for the dropdown list to apply with the DHCP Relay function. It can be the available WAN interface(s), and L2TP connection.
<b>Server IP</b>	<ol style="list-style-type: none"> <li>A Must filled setting.</li> <li>null by default.</li> </ol>	Assign a <b>DHCP Server IP Address</b> that the gateway will relay the DHCP requests to the assigned DHCP server via specified WAN interface.
<b>DHCP OPTION 82</b>	The box is unchecked by default.	Click <b>Enable</b> box to activate DHCP OPTION 82 function. Option 82 is organized as a single DHCP option that contains circuit-ID information known by the relay agent. If the relayed DHCP server required the such information, you have to enable it, otherwise, just leave it as unchecked.
<b>Enable</b>	The box is unchecked by default.	Click <b>Enable</b> box to activate this setting.
<b>Save</b>	NA	Click the <b>Save</b> button to save the setting.
<b>Undo</b>	NA	When the <b>Undo</b> button is clicked the screen will return back with nothing changed.

# 4G LTE M2M Router

## 2.3 WiFi

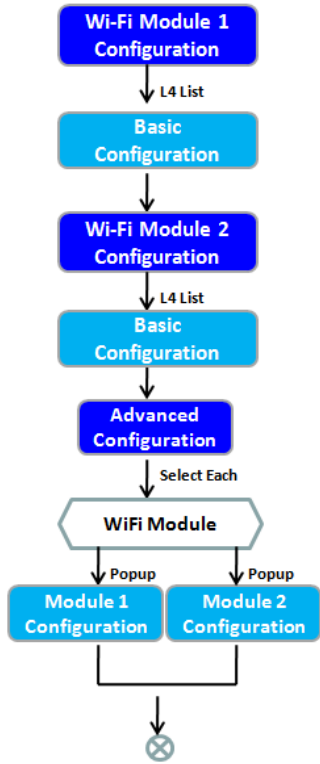

Basic Configuration	
Item	Setting
Operation Band	2.4G Single Band

2.4G WiFi Configuration	
Item	Setting
WiFi Module	<input checked="" type="checkbox"/> Enable
Channel	Auto <input checked="" type="radio"/> By AP Numbers <input type="radio"/> By Less Interference
WiFi System	802.11b/g/n Mixed
WiFi Operation Mode	AP Router Mode
Green AP	<input type="checkbox"/> Enable
VAP Isolation	<input checked="" type="checkbox"/> Enable
Time Schedule	(0) Always

2.4G VAP List		Add	Delete					
ID	VAP	SSID	Authentication	Encryption	STA Isolation	Broadcast SSID	Enable	Actions

The gateway provides WiFi interface for mobile devices or BYOD devices to connect for Internet/Intranet accessing. WiFi function is usually modularized design in a gateway, and there can be single or dual modules within a gateway. The WiFi system in the gateway complies with IEEE 802.11ac/11n/11g/11b standard in 2.4GHz or 5GHz single band or 2.4G/5GHz concurrent dual bands of operation. There are several wireless operation modes provided by this device. They are: “AP Router Mode”, “WDS Only Mode”, and “WDS Hybrid Mode”. You can choose the expected mode from the wireless operation mode list.

There are some sub-sections for you to configure the WiFi function, including “Basic Configuration” and “Advanced Configuration”. In Basic Configuration section, you have to finish almost all the settings for using the WiFi function. And the Advanced Configuration section provides more parameters for advanced user to fine tune the connectivity performance for the WiFi function.

# 4G LTE M2M Router

## 2.3.1 WiFi Configuration

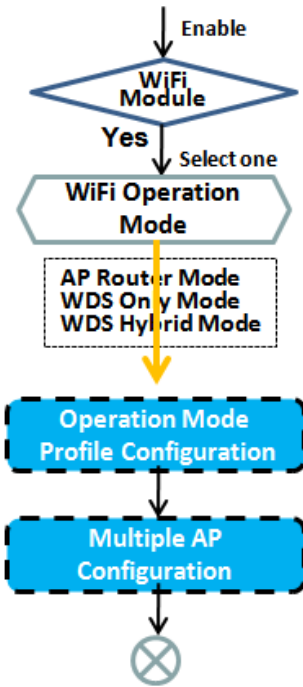

2.4G WiFi Configuration	
Item	Setting
WiFi Module	<input checked="" type="checkbox"/> Enable
Channel	Auto
WiFi System	802.11b/g/n Mixed
WiFi Operation Mode	AP Router Mode
Green AP	<input type="checkbox"/> Enable
VAP Isolation	<input checked="" type="checkbox"/> Enable
Time Schedule	(0) Always

2.4G VAP List								
ID	VAP	SSID	Authentication	Encryption	STA Isolation	Broadcast SSID	Enable	Actions
1	VAP 1	Staff_2.4G	WPA2-PSK	AES	<input type="checkbox"/>	<input checked="" type="checkbox"/>	<input checked="" type="checkbox"/>	Edit Select
2	VAP 2	default	Open	None	<input type="checkbox"/>	<input checked="" type="checkbox"/>	<input checked="" type="checkbox"/>	Edit Select

  

VAP Configuration	
Item	Setting
VAP	VAP1
SSID	Staff_2.4G
Max STA	<input type="checkbox"/> Enable
Authentication	WPA2-PSK
Encryption	AES
Preshared Key	1234567890
STA Isolation	<input checked="" type="checkbox"/>
Broadcast SSID	<input checked="" type="checkbox"/>
Enable	<input checked="" type="checkbox"/>

Due to optional module(s) and frequency band, you need to setup module one by one. For each module, you need to specify the operation mode, and then setup the virtual APs for wireless access.

Hereunder are the scenarios for each wireless operation mode, you can get how it works, and what is the difference among them. To connect your wireless devices with the wireless gateway, make sure your application scenario for WiFi network and choose the most adequate operation mode.

### AP Router Mode

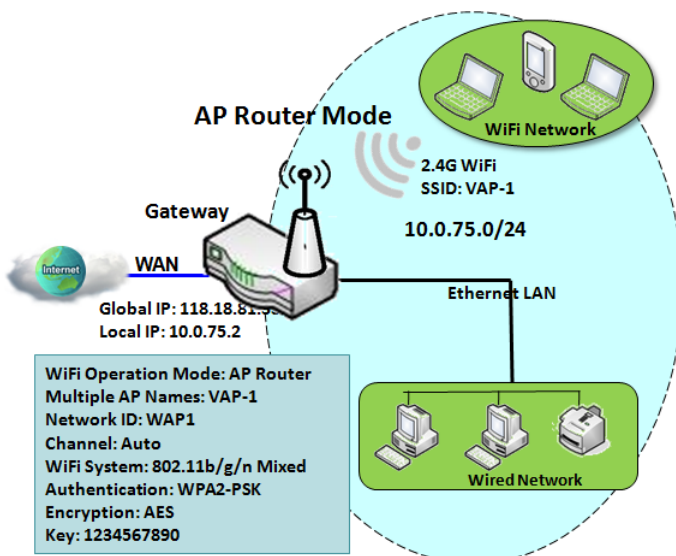

This mode allows you to get your wired and wireless devices connected to form the Intranet of the wireless gateway, and the Intranet will link to the Internet with NAT mechanism of the gateway. So, this gateway is working as a WiFi AP, but also a WiFi hotspot for Internet accessing service. It means local WiFi clients can associate to it, and go to Internet. With its NAT mechanism, all of wireless clients don't need to get public IP addresses from ISP.

# 4G LTE M2M Router

## WDS Only Mode

Gateway 2 & 3 Settings:  
[Configuration]-[WiFi Configuration]

WiFi Operation Mode: WDS Only  
Lazy Mode: Enable  
Channel: 3  
Authentication: WPA2-PSK  
Encryption: AES  
Key: 1234567890

Gateway 1 Settings:

[Configuration]-[WiFi Configuration]

WiFi Operation Mode: WDS Only  
Lazy Mode: Disable  
Channel: 3  
Authentication: WPA2-PSK  
Encryption: AES  
Key: 1234567890

[Configuration]-[Remote AP's MAC]

Remote AP MAC1: MAC of Gateway 2  
Remote AP MAC2: MAC of Gateway 3  
Remote AP MAC3:

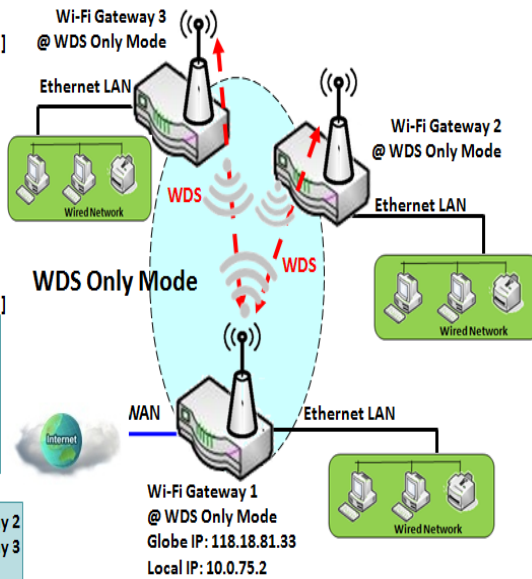

WDS (Wireless Distributed System) Only mode drives a WiFi gateway to be a bridge for its wired Intranet and a repeater to extend distance. You can use multiple WiFi gateways as a WiFi repeater chain with all gateways setup as "WDS Only" mode. All gateways can communicate with each other through WiFi. All wired client hosts within each gateway can also communicate each other in the scenario. Only one gateway within repeater chain can be DHCP server to provide IP for all wired client hosts of every gateway which being disabled DHCP server. This gateway can be NAT router to provide internet access

The diagram illustrates that there are two wireless gateways 2, 3 running at "WDS Only"

mode. They both use channel 3 to link to local Gateway 1 through WDS. Both gateways connected by WDS need to setup the remote AP MAC for each other. All client hosts under gateway 2, 3 can request IP address from the DHCP server at gateway 1. Besides, wireless Gateway 1 also execute the NAT mechanism for all client hosts Internet accessing.

## WDS Hybrid Mode

Gateway 2 / AP 1 Settings:  
[Configuration]-[WiFi Configuration]

WiFi Operation Mode: WDS Hybrid  
Lazy Mode: Enable  
Multiple AP Names: VAP1  
Network ID: Extended-WiFi  
Channel: same as Router 1  
Authentication: same as Router 1  
Encryption: same as Router 1  
Key: same as Router 1

Gateway 1 Settings:  
[Configuration]-[WiFi Configuration]

WiFi Operation Mode: WDS Hybrid  
Lazy Mode: Disable  
Multiple AP Names: VAP1  
Network ID: Extended-WiFi  
Channel: 3  
Authentication: WPA2-PSK  
Encryption: AES  
Key: 1234567890

[Configuration]-[Remote AP's MAC]

Remote AP MAC1: MAC of Router 2  
Remote AP MAC2: MAC of AP 1  
Remote AP MAC3:

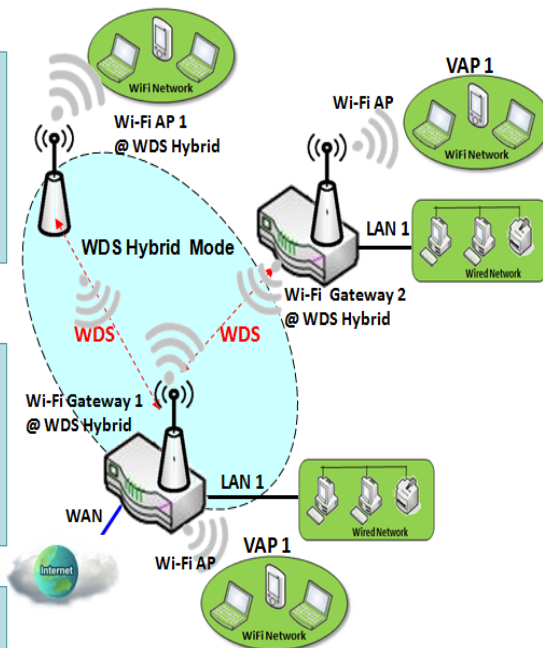

WDS hybrid mode includes both WDS and AP Router mode. WDS Hybrid mode can act as an access point for its WiFi Intranet and a WiFi bridge for its wired and WiFi Intranets at the same time. Users can thus use the features to build up a large wireless network in a large space LAN like airports, hotels or campus.

The diagram illustrates Gateway 1, Gateway 2 and AP 1 connected by WDS. Each gateway has access point function for WiFi client access. Gateway 1 has DHCP server to assign IP to each client hosts. All gateways and AP are under WDS hybrid mode. To setup WDS hybrid mode, it need to fill all configuration items similar to that of AP-router and WDS modes.

# 4G LTE M2M Router

## Multiple VAPs

### Gateway Settings:

WiFi Operation Mode: AP Router  
**VAP1**  
 SSID: VAP-1  
 Authentication: WPA2-PSK  
 Encryption: TKIP  
 Key: 1234567890

**VAP2**  
 SSID: VAP-2  
 Authentication: WPA2-PSK  
 Encryption: TKIP  
 Key: 1234567890

**VAP3**  
 SSID: VAP-3  
 Authentication: WPA2  
 Encryption: TKIP  
 RADIUS Server IP: 192.168.168.  
 RADIUS Server Port: 1812  
 RADIUS Shared Key

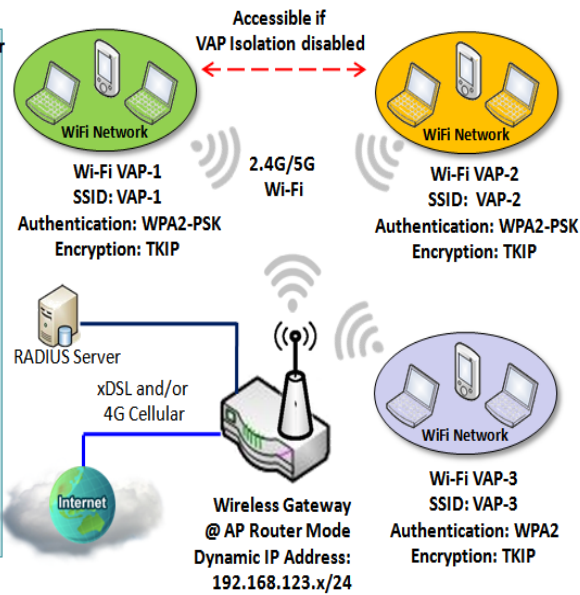

VAP (Virtual Access Point) is function to partition wireless network into multiple broadcast domains. It can simulate multiple APs in one physical AP. This wireless gateway supports up to 8 VAPs. For each VAP, you need to setup SSID, authentication and encryption to control Wi-Fi client access.

Besides, there is a VAP isolation option to manage the access among VAPs. You can allow or blocks communication for the wireless clients connected to different VAPs. As shown in the diagram, the clients in VAP-1 and VAP-2 can communicate to each other when VAP Isolation is disabled.

## Wi-Fi Security – Authentication & Encryption

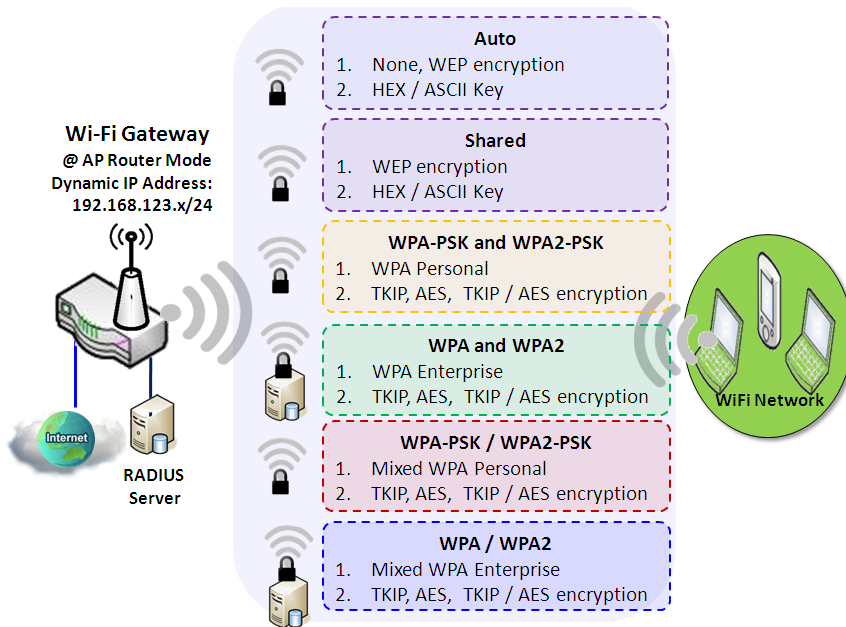

Wi-Fi security provides complete authentication and encryption mechanisms to enhance the data security while your data is transferred wirelessly over the air. The wireless gateway supports Shared, WPA-PSK / WPA2-PSK and WPA / WPA2 authentication. You can select one authentication scheme to validate the wireless clients while they are connecting to the AP. As to the data encryption, the gateway supports WEP, TKIP and AES. The selected encryption algorithm will be applied to the data while the wireless connection is established.

# 4G LTE M2M Router

## WiFi Configuration Setting

The WiFi configuration allows user to configure 2.4GHz or 5GHz WiFi settings.

Go to **Basic Network > WiFi > WiFi Module One** Tab. If the gateway is equipped with two WiFi modules, there will be another **WiFi Module Two**. You can do the similar configurations on both WiFi modules.

### Basic Configuration

Basic Configuration	
Item	Setting
▶ Operation Band	2.4G Single Band

Item	Value setting	Description
<b>Operation Band</b>	A Must filled setting	Specify the intended operation band for the WiFi module. Basically, this setting is fixed and cannot be changed once the module is integrated into the product. However, there is some module with selectable band for user to choose according to his network environment. Under such situation, you can specify which operation band is suitable for the application.

### Configure WiFi Setting

2.4G WiFi Configuration	
Item	Setting
▶ WiFi Module	<input checked="" type="checkbox"/> Enable
▶ Channel	Auto <input checked="" type="radio"/> By AP Numbers <input type="radio"/> By Less Interference
▶ WiFi System	802.11b/g/n Mixed
▶ WiFi Operation Mode	AP Router Mode

Item	Value setting	Description
<b>WiFi Module</b>	The box is checked by default	Check the <b>Enable</b> box to activate Wi-Fi function.
<b>Channel</b>	1. A Must filled setting. 2. <b>Auto</b> is selected be default.	Select a radio channel for the VAP. Each channel is corresponding to different radio band. The permissible channels depend on the <b>Regulatory Domain</b> . There are two available options when <b>Auto</b> is selected: ● <b>By AP Numbers</b> The channel will be selected according to AP numbers (The less, the better).

# 4G LTE M2M Router

		<ul style="list-style-type: none"> <li>● <b>By Less Interference</b> The channel will be selected according to interference. (The lower, the better).</li> </ul>
<b>WiFi System</b>	A Must filled setting	Specify the preferred WiFi System. The dropdown list of <b>WiFi system</b> is based on <b>IEEE 802.11</b> standard. <ul style="list-style-type: none"> <li>● <b>2.4G WiFi</b> can select b, g and n only or mixed with each other.</li> <li>● <b>5G WiFi</b> can select a, n and ac only or mixed with each other.</li> </ul>
<b>WiFi Operation Mode</b>		Specify the <b>WiFi Operation Mode</b> according to your application. Go to the following table for <b>AP Router Mode</b> , <b>WDS Only Mode</b> , and <b>WDS Hybrid Mode</b> settings.  Note: The available operation modes depend on the product specification.

In the following, the specific configuration description for each WiFi operation mode is given.

## AP Router Mode & VAPs Configuration

For the AP Router mode, the device not only supports **stations connection** but also the **router function**. The **WAN** port and the **NAT** function are **enabled**.

▶ WiFi Operation Mode	AP Router Mode ▾
▶ Green AP	<input type="checkbox"/> Enable
▶ VAP Isolation	<input checked="" type="checkbox"/> Enable
▶ Time Schedule	(0) Always ▾

AP Router Mode		
Item	Value setting	Description
<b>Green AP</b>	The box is unchecked by default.	Check the <b>Enable</b> box to activate <b>Green AP</b> function.
<b>VAP Isolation</b>	The box is checked by default.	Check the <b>Enable</b> box to activate this function. By default, the box is checked; it means that stations which associated to different VAPs cannot communicate with each other.
<b>Time Schedule</b>	A Must filled setting	Apply a specific <b>Time Schedule</b> to this rule; otherwise leave it as <b>(0) Always</b> . If the dropdown list is empty ensure <b>Time Schedule</b> is pre-configured. Refer to <b>Object Definition &gt; Scheduling &gt; Configuration</b> tab.

2.4G VAP List								
ID	VAP	SSID	Authentication	Encryption	STA Isolation	Broadcast SSID	Enable	Actions
1	VAP 1	DWM-313-C203	WPA2-PSK	AES	<input type="checkbox"/>	<input checked="" type="checkbox"/>	<input checked="" type="checkbox"/>	<input type="button" value="Edit"/> <input type="checkbox"/> Select

By default, VAP 1 is enabled and security key is required to connect to the gateway wirelessly to enhance the security level and prevent unexpected access of un-authorized devices.

**The default wifi key is printed on both the device label and the Security Card. It is created randomly and differs from devices. So, you can connected to the VAP1 (SSID: DWM-313-XXXX) with the provided key.**

**However, it is strongly recommended that you have to change the security key to a easy-to-remember one by clicking the Edit button.**

# 4G LTE M2M Router

Click **Add / Edit** button in the VAP List screen to create or edit the settings for a VAP. A VAP Configuration screen will appear.

For VAP 1:

2.4G VAP Configuration	
Item	Setting
VAP	VAP1
SSID	DWM-313-C203
Max. STA	<input type="checkbox"/> Enable
Authentication	WPA2-PSK
Encryption	AES
Preshared Key	Ss8bF86p
STA Isolation	<input type="checkbox"/>
Broadcast SSID	<input checked="" type="checkbox"/>
Enable	<input checked="" type="checkbox"/>

Save

For others:

VAP Configuration	
Item	Setting
VAP	VAP2
SSID	default
Max. STA	<input type="checkbox"/> Enable
Authentication	Open
Encryption	None
STA Isolation	<input type="checkbox"/>
Broadcast SSID	<input type="checkbox"/>
Enable	<input type="checkbox"/>

VAP Configuration		
Item	Value setting	Description
<b>SS ID</b>	1. String format : Any text	Enter the SSID for the VAP, and decide whether to broadcast the SSID or not. The <b>SSID</b> is used for identifying from another AP, and client stations will associate with AP according to SSID.
<b>Max. STA</b>	The box is unchecked by default.	Check this box and enter a limitation to limit the maximum number of client station. The box is unchecked by default. It means no special limitation on the number of connected STAs.
<b>Authentication</b>	1. A Must filled setting 2. VAP1: <b>WPA2-PSK</b> is selected be default; Others: <b>Open</b> is	For security, there are several authentication methods supported. Client stations should provide the key when associate with this device. When <b>Open</b> is selected The check box named <b>802.1x</b> shows up next to the dropdown list.

# 4G LTE M2M Router

	<p>selected be default.</p> <ul style="list-style-type: none"> <li>● <b>802.1x</b> (The box is unchecked by default) When <b>802.1x</b> is enabled, it means the client stations will be authenticated by RADIUS server. <b>RADIUS Server IP</b> (The default IP is 0.0.0.0) <b>RADIUS Server Port</b> (The default value is 1812) <b>RADIUS Shared Key</b></li> </ul> <hr/> <p>When <b>Shared</b> is selected The pre-shared WEP key should be set for authenticating.</p> <hr/> <p>When <b>Auto</b> is selected The device will select <b>Open</b> or <b>Shared</b> by requesting of client automatically. The check box named <b>802.1x</b> shows up next to the dropdown list.</p> <ul style="list-style-type: none"> <li>● <b>802.1x</b> (The box is unchecked by default) When <b>802.1x</b> is enabled, it means the client stations will be authenticated by RADIUS server. <b>RADIUS Server IP</b> (The default IP is 0.0.0.0) <b>RADIUS Server Port</b> (The default value is 1812) <b>RADIUS Shared Key</b></li> </ul> <hr/> <p>When <b>WPA</b> or <b>WPA2</b> is selected They are implementation of IEEE 802.11i. <b>WPA</b> only had implemented part of IEEE 802.11i, but owns the better <b>compatibility</b>. <b>WPA2</b> had fully implemented 802.11i standard, and owns the highest <b>security</b>.</p> <ul style="list-style-type: none"> <li>● <b>RADIUS Server</b> The client stations will be authenticated by RADIUS server. <b>RADIUS Server IP</b> (The default IP is 0.0.0.0) <b>RADIUS Server Port</b> (The default value is 1812) <b>RADIUS Shared Key</b></li> </ul> <hr/> <p>When <b>WPA / WPA2</b> is selected It owns the same setting as <b>WPA</b> or <b>WPA2</b>. The client stations can associate with this device via <b>WPA</b> or <b>WPA2</b>.</p> <hr/> <p>When <b>WPA-PSK</b> or <b>WPA2-PSK</b> is selected It owns the same encryption system as WPA or WPA2. The authentication uses pre-shared key instead of RADIUS server.</p> <hr/> <p>When <b>WPA-PSK / WPA2-PSK</b> is selected It owns the same setting as <b>WPA-PSK</b> or <b>WPA2-PSK</b>. The client stations can associate with this device via <b>WPA-PSK</b> or <b>WPA2-PSK</b>.</p>
<p><b>Encryption</b></p> <p>1. A Must filled setting. 2. VAP1: <b>AES</b> is selected be default; Others: <b>None</b> is selected be default.</p>	<p>Select a suitable encryption method and enter the required key(s). The available method in the dropdown list depends on the Authentication you selected.</p> <p><b>None</b> It means that the device is open system without encrypting.</p> <p><b>WEP</b> Up to 4 WEP keys can be set, and you have to select one as current key. The key type can set to <b>HEX</b> or <b>ASCII</b>. If <b>HEX</b> is selected, the key should consist of (0 to 9) and (A to F). If <b>ASCII</b> is selected, the key should consist of ASCII table.</p> <p><b>TKIP</b> TKIP was proposed instead of WEP without upgrading hardware. Enter a Pre-shared Key for it. The length of key is from 8 to 63 characters.</p> <p><b>AES</b> The newest encryption system in WiFi, it also designed for the fast 802.11n high bitrates schemes. Enter a Pre-shared Key for it. The length of key is from 8 to 63 characters.</p>

# 4G LTE M2M Router

		<p>You are recommended to use <b>AES</b> encryption instead of any others for security.</p> <p><b>TKIP / AES</b>  <b>TKIP / AES</b> mixed mode. It means that the client stations can associate with this device via <b>TKIP</b> or <b>AES</b>. Enter a Pre-shared Key for it. The length of key is from 8 to 63 characters.</p>
<b>STA Isolation</b>	VAP1: The box is checked by default; Others: unchecked by default.	<p>Check the <b>Enable</b> box to activate this function.</p> <p>By default, the box is checked; it means that stations which associated to the same VAP cannot communicate with each other.</p>
<b>Broadcast SSID</b>	VAP1: The box is checked by default; Others: unchecked by default.	<p>Check the <b>Enable</b> box to activate this function.</p> <p>If the broadcast SSID option is enabled, it means the SSID will be broadcasted, and the stations can associate with this device by scanning SSID.</p>
<b>Enable</b>	VAP1: The box is checked by default; Others: unchecked by default.	<p>Check the <b>Enable</b> box to activate this VAP.</p>
<b>Save</b>	N/A	Click the <b>Save</b> button to save the current configuration.
<b>Undo</b>	N/A	Click the <b>Undo</b> button to restore configuration to previous setting before saving.
<b>Apply</b>	N/A	Click the <b>Apply</b> button to apply the saved configuration.

# 4G LTE M2M Router

## WDS Only Mode

For the WDS Only mode, the device only bridges the connected wired clients to another WDS-enabled WiFi device which the device associated with. That is, it also means the no wireless clients stat can connect to this device while WDS Only Mode is selected.

WiFi Operation Mode	WDS Only Mode ▾
Green AP	<input type="checkbox"/> Enable
Time Schedule	(0) Always ▾
Scan Remote AP's MAC List	Scan
Remote AP MAC 1	<input type="text"/>
Remote AP MAC 2	<input type="text"/>
Remote AP MAC 3	<input type="text"/>
Remote AP MAC 4	<input type="text"/>

WDS Only Mode		
Item	Value setting	Description
<b>Green AP</b>	The box is unchecked by default.	Check the <b>Enable</b> box to activate <b>Green AP</b> function.
<b>Time Schedule</b>	A Must filled setting	Apply a specific <b>Time Schedule</b> to this rule; otherwise leave it as <b>(0) Always</b> . If the dropdown list is empty ensure <b>Time Schedule</b> is pre-configured. Refer to <b>Object Definition &gt; Scheduling &gt; Configuration</b> tab.
<b>Scan Remote AP's MAC List</b>	N/A	Press the <b>Scan</b> button to scan the spatial AP information, and then select one from the AP list, the MAC of selected AP will be auto filled in the following Remote AP MAC table.
<b>Remote AP MAC 1~4</b>	A Must filled setting	Enter the remote AP's MAC manually, or via auto-scan approach, The device will bridge the traffic to the remote AP when associated successfully.

2.4G VAP List								Add	Delete
ID	VAP	SSID	Authentication	Encryption	STA Isolation	Broadcast SSID	Enable	Actions	
1	VAP 1	DWM-313-C203	WPA2-PSK	AES	<input type="checkbox"/>	<input checked="" type="checkbox"/>	<input checked="" type="checkbox"/>	Edit <input type="checkbox"/> Select	

By default, VAP 1 is enabled and security key is required to connect to the gateway wirelessly to enhance the security level and prevent unexpected access of un-authorized devices.

**The default wifi key is printed on both the device label and the Security Card. It is created randomly and differs from devices. So, you can connected to the VAP1 (SSID: DWM-313-XXXX) with the provided key.**

**However, it is strongly recommended that you have to change the security key to a easy-to-remember one by clicking the Edit button.**

# 4G LTE M2M Router

Under **WDS Only** mode, only VAP1 is available for further specifying the required authentication and Encryption settings. Click **Edit** button in the VAP List screen and a VAP Configuration screen will appear for you to configure the required settings

The screenshot shows the '2.4G VAP Configuration' interface. It features a table with two columns: 'Item' and 'Setting'. The settings are as follows:

Item	Setting
▶ VAP	VAP1 ▼
▶ SSID	DWM-313-C203
▶ Max. STA	<input type="checkbox"/> Enable
▶ Authentication	WPA2-PSK ▼
▶ Encryption	AES ▼
▶ Preshared Key	Ss8bF86p
▶ STA Isolation	<input type="checkbox"/>
▶ Broadcast SSID	<input checked="" type="checkbox"/>
▶ Enable	<input checked="" type="checkbox"/>

At the bottom right of the configuration area, there is a 'Save' button.

For the detail description about VAP configuration, please refer to the description stated in AP-Router section.

# 4G LTE M2M Router

## WDS Hybrid Mode

For the WDS Hybrid mode, the device bridges all the wired **LAN** and **WLAN** clients to another WDS or WDS hybrid enabled WiFi devices which the device associated with.

WiFi Operation Mode	WDS Hybrid Mode ▾
Lazy Mode	<input type="checkbox"/> Enable
Green AP	<input type="checkbox"/> Enable
VAP Isolation	<input checked="" type="checkbox"/> Enable
Time Schedule	(0) Always ▾
Scan Remote AP's MAC List	Scan
Remote AP MAC 1	<input type="text"/>
Remote AP MAC 2	<input type="text"/>
Remote AP MAC 3	<input type="text"/>
Remote AP MAC 4	<input type="text"/>

WDS Hybrid Mode		
Item	Value setting	Description
<b>Lazy Mode</b>	The box is checked by default.	Check the <b>Enable</b> box to activate this function. With the function been enabled, the device can auto-learn WDS peers without manually entering other AP's MAC address. But at least one of the APs has to fill remote AP MAC addresses.
<b>Green AP</b>	The box is unchecked by default.	Check the <b>Enable</b> box to activate <b>Green AP</b> function.
<b>VAP Isolation</b>	The box is checked by default.	Check the <b>Enable</b> box to activate this function. By default, the box is checked; it means that stations which associated to different VAPs cannot communicate with each other.
<b>Time Schedule</b>	A Must filled setting	Apply a specific <b>Time Schedule</b> to this rule; otherwise leave it as <b>(0) Always</b> . If the dropdown list is empty ensure <b>Time Schedule</b> is pre-configured. Refer to <b>Object Definition &gt; Scheduling &gt; Configuration</b> tab.
<b>Scan Remote AP's MAC List</b>	Available when Lazy Mode disabled.	Press the <b>Scan</b> button to scan the spatial AP information, and then select one from the AP list, the MAC of selected AP will be auto filled in the following Remote AP MAC table.
<b>Remote AP MAC 1~4</b>	Available when Lazy Mode disabled.	Enter the remote AP's MAC manually, or via auto-scan approach, The device will bridge the traffic to the remote AP when associated successfully.

4G VAP List									
ID	VAP	SSID	Authentication	Encryption	STA Isolation	Broadcast SSID	Enable	Actions	
1	VAP 1	DWM-313-C203	WPA2-PSK	AES	<input type="checkbox"/>	<input checked="" type="checkbox"/>	<input checked="" type="checkbox"/>	<input type="button" value="Edit"/>	<input type="checkbox"/> Select

By default, VAP 1 is enabled and security key is required to connect to the gateway wirelessly to enhance the security level and prevent unexpected access of un-authorized devices.

**The default wifi key is printed on both the device label and the Security Card. It is created randomly and differs from devices. So, you can connected to the VAP1 (SSID: DWM-313-XXXX) with the provided key. However, it is strongly recommended that you have to change the security key to a easy-to-remember one**

# 4G LTE M2M Router

by clicking the **Edit** button.

Under **WDS Hybrid** mode, the VAP function is available and you can further specifying the required VAP settings for connecting with wireless client devices.

Click **Add / Edit** button in the VAP List screen to create or edit the settings for a VAP. A VAP Configuration screen will appear.

For VAP 1:

2.4G VAP Configuration	
Item	Setting
▶ VAP	VAP1 ▼
▶ SSID	DWM-313-C203
▶ Max. STA	<input type="checkbox"/> Enable
▶ Authentication	WPA2-PSK ▼
▶ Encryption	AES ▼
▶ Preshared Key	Ss8bF86p
▶ STA Isolation	<input type="checkbox"/>
▶ Broadcast SSID	<input checked="" type="checkbox"/>
▶ Enable	<input checked="" type="checkbox"/>

# 4G LTE M2M Router

For others:

VAP Configuration	
Item	Setting
▶ VAP	VAP2
▶ SSID	default
▶ Max. STA	<input type="checkbox"/> Enable
▶ Authentication	Open
▶ Encryption	None
▶ STA Isolation	<input type="checkbox"/>
▶ Broadcast SSID	<input type="checkbox"/>
▶ Enable	<input type="checkbox"/>

For the detail description about VAP configuration, please refer to the description stated in AP-Router section.

# 4G LTE M2M Router

## 2.3.2 Wireless Client List

The **Wireless Client List** page shows the information of wireless clients which are associated with this device.

Go to **Basic Network > WiFi > Wireless Client List** Tab.

### Select Target WiFi

Target WiFi	
Item	Setting
▶ Module Select	One ▾
▶ Operation Band	2.4G ▾
▶ Multiple AP Names	All ▾

Item	Value setting	Description
<b>Module Select</b>	A Must filled setting.	Select the WiFi module to check the information of connected clients. For those single WiFi module products, this option is hidden.
<b>Operation Band</b>	A Must filled setting.	Specify the intended operation band for the WiFi module. Basically, this setting is fixed and cannot be changed once the module is integrated into the product. However, there is some module with selectable band for user to choose according to his network environment. Under such situation, you can specify which operation band is suitable for the application.
<b>Multiple AP Names</b>	1. A Must filled setting. 2. <b>All</b> is selected by default.	Specify the VAP to show the associated clients information in the following Client List. By default, All VAP is selected.

### Show Client List

The following Client List shows the information for wireless clients that is associated with the selected VAP(s).

Client List								
IP Address Configuration & Address	Host Name	MAC Address	Mode	Rate	RSSI0	RSSI1	Signal	Interface

Item	Value setting	Description
<b>IP Address Configuration &amp; Address</b>	N/A	It shows the Client's IP address and the deriving method. <b>Dynamic</b> means the IP address is derived from a DHCP server. <b>Static</b> means the IP address is a fixed one that is self-filled by client.
<b>Host Name</b>	N/A	It shows the host name of client.
<b>MAC Address</b>	N/A	It shows the MAC address of client.
<b>Mode</b>	N/A	It shows what kind of <b>Wi-Fi system</b> the client used to associate with this device.
<b>Rate</b>	N/A	It shows the <b>data rate</b> between client and this device.

# 4G LTE M2M Router

<b>RSSI0, RSSI1</b>	N/A	It shows the RX sensitivity (RSSI) value for each radio path.
<b>Signal</b>	N/A	The <b>signal strength</b> between client and this device.
<b>Interface</b>	N/A	It shows the VAP ID that the client associated with.
<b>Refresh</b>	N/A	Click the <b>Refresh</b> button to update the Client List immediately.

# 4G LTE M2M Router

## 2.3.3 Advanced Configuration

This device provides advanced wireless configuration for professional user to optimize the wireless performance under the specific installation environment. Please note that if you are not familiar with the WiFi technology, just leave the advanced configuration with its default values, or the connectivity and performance may get worse with improper settings.

Go to **Basic Network > WiFi > Advanced Configuration** Tab.

### Select Target WiFi

Target WiFi	
Item	Setting
▶ Module Select	One ▼
▶ Operation Band	2.4G ▼

Target Configuration		
Item	Value setting	Description
<b>Module Select</b>	A Must filled setting.	Select the WiFi module to check the information of connected clients. For those single WiFi module products, this option is hidden.
<b>Operation Band</b>	A Must filled setting.	Specify the intended operation band for the WiFi module. Basically, this setting is fixed and cannot be changed once the module is integrated into the product. However, there is some module with selectable band for user to choose according to his network environment.

### Setup Advanced Configuration

Advanced Configuration	
Item	Setting
▶ Regulatory Domain	(36, 40, 44, 48, 149, 153, 157, 161, 165)
▶ Beacon Interval	100 Range: (1~1000 msec)
▶ DTIM Interval	3 Range: (1~255)
▶ RTS Threshold	2347 Range: (1~2347)
▶ Fragmentation	2346 Range: (256~2346)
▶ WMM	<input checked="" type="checkbox"/> Enable
▶ Short GI	400ns ▼
▶ TX Rate	Best ▼
▶ RF Bandwidth	Auto ▼
▶ Transmit Power	100% ▼
▶ 5G Band Steering	<input type="checkbox"/> Enable
▶ WIDS	<input type="checkbox"/> Enable

# 4G LTE M2M Router

▶ Dynamic Frequency Selection  Enable

Advanced Configuration		
Item	Value setting	Description
<b>Regulatory Domain</b>	The default setting is according to where the product sale to	It limits the available radio channel of this device. The permissible channels depend on the <b>Regulatory Domain</b> .
<b>Beacon Interval</b>	100	It shows the time interval between each beacon packet broadcasted. The beacon packet contains <b>SSID</b> , <b>Channel ID</b> and <b>Security setting</b> .
<b>DTIM Interval</b>	3	A <b>DTIM (Delivery Traffic Indication Message)</b> is a countdown informing clients of the next window for listening to broadcast message. When the device has buffered broadcast message for associated client, it sends the next DTIM with a DTIM value.
<b>RTS Threshold</b>	2347	<b>RTS (Request to send) Threshold</b> means when the packet size is over the setting value, then active <b>RTS</b> technique. RTS/CTS is a <b>collision avoidance</b> technique. It means RTS <b>never</b> activated when the threshold is set to <b>2347</b> .
<b>Fragmentation</b>	2346	Wireless frames can be divided into smaller units (fragments) to <b>improve performance</b> in the presence of RF interference at the limits of RF coverage.
<b>WMM</b>	The box is checked by default	<b>WMM (WiFi Multimedia)</b> can help control <b>latency</b> and <b>jitter</b> when transmitting <b>multimedia content</b> over a wireless connection.
<b>Short GI</b>	By default <b>400ns</b> is selected	<b>Short GI (Guard Interval)</b> is defined to set the sending interval between each packet. Note that lower <b>Short GI</b> could <b>increase</b> not only the <b>transition rate</b> but also <b>error rate</b> .
<b>TX Rate</b>	By default <b>Best</b> is selected	It means the <b>data transition rate</b> . When <b>Best</b> is selected, the device will choose a proper <b>data rate</b> according to <b>signal strength</b> .
<b>RF Bandwidth</b>	By default <b>Auto</b> is selected	The setting of RF bandwidth limits the maximum data rate.
<b>Transmit Power</b>	By default <b>100%</b> is selected	Normally the wireless transmitter operates at 100% power. By setting the <b>transmit power</b> to control the WiFi <b>coverage</b> .
<b>5G Band Steering</b>	The box is unchecked by default	When the client station associate with 2.4G WiFi, the device will send the client to 5G WiFi automatically if the client is available on accessing this 5G Wi-Fi band. This option is only available on the module that supports 5GHz band.
<b>WIDS</b>	The box is unchecked by default	The WIDS (Wireless Intrusion Detection System) will analyze all packets and make a statistic table in WiFi status. Go to <b>Status &gt; Basic Network &gt; WiFi</b> tab for detailed WIDS status.
<b>Dynamic Frequency Selection</b>	The box is checked by default	<b>Dynamic Frequency Selection (DFS)</b> is a legally required feature for all WiFi devices that share the 5 GHz band with radar. DFS enables a gateway to detect radar signals and switch their operating frequency to prevent interference. This process ensures that radar systems send and receive accurate information.  <b>Note:</b> Dynamic Frequency Selection (DFS) option is only available for the WiFi module with 5GHz radio.
<b>Save</b>	N/A	Click the <b>Save</b> button to save the current configuration.
<b>Undo</b>	N/A	Click the <b>Undo</b> button to restore configuration to previous setting before saving.

# 4G LTE M2M Router

## 2.3.4 Uplink Profile

This device provides WiFi Uplink function for connecting to a wireless access point just like connected to a wired WAN or cellular WAN connection. It can operate as a NAT gateway and link the devices wirelessly to the uplink network or hosts.

To connect to the wireless access point, user has to enable the wireless Uplink function for a certain WiFi Module (refer to **Basic Network > WAN & Uplink > Physical Interface, Internet Setup** tabs) first, and then configure the Uplink profile(s) for the access point to be connected to in the **Uplink Profile** page.

Go to **Basic Network > WiFi > Uplink Profile** tab for configuring the Uplink Profile page.

### Uplink Profile Setting

Item	Setting
▶ Profile	<input type="checkbox"/> Enable
▶ Module Select	One ▼
▶ Operation Band	2.4G ▼
▶ Priority	<input checked="" type="radio"/> By Signal Strength <input type="radio"/> By User-defined
▶ Current Profile	

Setting Item	Value setting	Description
<b>Profile</b>	1. A Must filled setting. 2. <b>Unchecked</b> by default.	Check the <b>Enable</b> box to activate the profile function. It is available only when the selected WiFi module is configured at WiFi Uplink mode.
<b>Module Select</b>	A Must filled setting.	Select the WiFi module to check or configure the expected uplink profile(s). For those single WiFi module products, this option is hidden.
<b>Operation Band</b>	A Must filled setting.	Specify the intended operation band for the WiFi module. Basically, this setting is fixed and cannot be changed once the module is integrated into the gateway product. However, there are some module with selectable band for user to choose according to his network environment. Under such situation, you can specify which operation band is suitable for the application.
<b>Priority</b>	1. A Must filled setting. 2. <b>By Signal Strength</b> is selected by default.	Specify the network selection methodology for connectin to an available wireless uplink network. It can be <b>By Signal Strength</b> or <b>By User-defined</b> priority. When <b>By Signal Strength</b> is selected, the gateway will try to connect to the available uplink network whose wireless signal strength is the strongest. When <b>By User-defined</b> is selected, the gateway will try to connect to the available uplink network whose priority is the highest (1 is the highest priority, and 16 is the lowest priority).
<b>Current Profile</b>	N/A	After enabling Profile and connecting by a certain uplink profile, the profile name will be displayed.

# 4G LTE M2M Router

Note: to apply the defined Uplink profile(s) for the gateway to find a best fit profile for connecting to a certain uplink network, user has to **Enable** the Profile auto-connect function (Refer to **Basic Network > WiFi > (Module 1/ Module 2) WiFi Configuration** tab).

## Create/Edit Uplink Profile

Profile List										
<span>Add</span> <span>Delete</span> <span>Get Signal Strength</span>										
ID	Profile Name	SSID	Channel	Authentication	Encryption	MAC Address	Signal Strength	Priority	Enable	Actions

The Profile List shows the settings for the created uplink profiles. The information includes Profile Name, SSID, Channel, Authentication, Encryption, MAC Address, Signal Strength, Priority, and Enable.

When **Add** button is applied, **Profile Configuration** screen will appear.

Profile Configuration	
Item	Setting
▶ Profile Name	<input type="text"/>
▶ Network ID (SSID)	<input type="text"/> <span>Scan</span>
▶ Channel	Auto ▼
▶ Authentication	Open ▼
▶ Encryption	None ▼
▶ MAC Address	<input type="text"/>
▶ Priority	16 ▼
▶ Enable	<input checked="" type="checkbox"/>

Profile Configuration		
Item	Value setting	Description
<b>Profile Name</b>	<ol style="list-style-type: none"> <li>String format can be any text</li> <li>A Must filled setting</li> </ol>	Enter a profile name for the uplink network specified below. It is a name that is easy for you to understand. <b>Value Range: 1 ~ 64 characters.</b>
<b>Network ID (SSID)</b>	<ol style="list-style-type: none"> <li>String format : Any text</li> <li>The box is checked by default.</li> </ol>	Enter the SSID for the VAP, and decide whether to broadcast the SSID or not. The <b>SSID</b> is used for identifying from another AP, and client stations will associate with AP according to SSID. If the broadcast SSID option is enabled, it means the SSID will be broadcasted, and the stations can associate with this device by scanning SSID.
<b>Channel</b>	<ol style="list-style-type: none"> <li>A Must filled setting.</li> <li><b>Auto</b> is selected by default.</li> </ol>	Select a radio channel for the VAP. Each channel is corresponding to different radio band. The permissible channels depend on the <b>Regulatory Domain</b> . There are two available options when <b>Auto</b> is selected: <ul style="list-style-type: none"> <li>● <b>By AP Numbers</b></li> </ul>

# 4G LTE M2M Router

		<p>The channel will be selected according to AP numbers (The less, the better).</p> <ul style="list-style-type: none"> <li>● <b>By Less Interference</b> The channel will be selected according to interference. (The lower, the better).</li> </ul>
<b>Authentication</b>	<ol style="list-style-type: none"> <li>1. A Must filled setting</li> <li>2. <b>Open</b> is selected by default.</li> </ol>	<p>Specify the authentication method for connecting with the uplink network. It can be <b>Open</b>, <b>Shared</b>, <b>WPA-SPK</b>, or <b>WPA2-PSK</b>.</p> <p>When <b>Open</b> is selected, the preshared WEP key could be set for authentication; When <b>Shared</b> is selected, the preshared WEP key should be set for authentication; When <b>WPA-PSK</b> or <b>WPA2-PSK</b> is selected, The the TKIP or AES preshared key should be set for authentication;</p>
<b>Encryption</b>	<ol style="list-style-type: none"> <li>1. A Must filled setting.</li> <li>2. <b>None</b> is selected by default.</li> </ol>	<p>Select a suitable encryption method and enter the required key(s). The available method in the dropdown list depends on the Authentication you selected.</p> <p><b>None</b> It means that the device is open system without encrypting.</p> <p><b>WEP</b> Up to 4 WEP keys can be set, and you have to select one as current key. The key type can set to <b>HEX</b> or <b>ASCII</b>. If <b>HEX</b> is selected, the key should consist of (0 to 9) and (A to F). If <b>ASCII</b> is selected, the key should consist of ASCII table.</p> <p><b>TKIP</b> TKIP was proposed instead of WEP without upgrading hardware. Enter a Preshared Key for it. The length of key is from 8 to 63 characters.</p> <p><b>AES</b> The newest encryption system in WiFi, it also designed for the fast 802.11n high bitrates schemes. Enter a Preshared Key for it. The length of key is from 8 to 63 characters. You are recommended to use <b>AES</b> encryption instead of any others for security.</p>
<b>MAC Address</b>	<ol style="list-style-type: none"> <li>1. MAC Address string Format</li> <li>2. A Must fill setting</li> </ol>	Specify the <b>MAC Address</b> of the access point (with the Network ID) to be connected to.
<b>Priority</b>	<ol style="list-style-type: none"> <li>1. An Optional filled setting.</li> <li>2. <b>16</b> is set by default.</li> </ol>	Specify a priority setting for the uplink profile when the <b>By User-defined</b> methodology is selected. The priority value can be 1 ~ 16. 1 is the highest priority, and 16 is the lowest priority).
<b>Enable</b>	The box is checked by default.	Click the <b>Enable</b> box to activate this profile.
<b>Save</b>	N/A	Click the <b>Save</b> button to save the configuration.
<b>Undo</b>	N/A	Click the <b>Undo</b> button to restore what you just configured back to the previous setting.
<b>Back</b>	N/A	When the <b>Back</b> button is clicked, the screen will return to the Profile List page.

Instead of manually enter the information for the uplink network, you can also click the **Scan** button to get the available wireless networks around the device, and select one as the uplink network.

When the **Scan** button is applied, **Wireless AP List** will appear after few seconds.

# 4G LTE M2M Router

Wireless AP List						
SSID	Channel	Quality	Authentication	Encryption	MAC Address	Select
Guest_2.4G	1	86%		None	02:50:78:56:79:15	<input type="radio"/>
WIN	1	100%	WPA2-PSK	AES	00:60:64:cb:f5:f6	<input type="radio"/>
amit02	1	63%	WPA2-PSK	AES	00:50:18:21:e2:17	<input type="radio"/>
Guest_2.4G	1	5%		None	1a:50:18:33:55:66	<input type="radio"/>
lan test_24_1	1	86%	WPA2-PSK	AES	00:50:18:56:79:15	<input type="radio"/>
lan test_24_3	1	89%	WPA2-PSK	AES	02:50:28:56:79:15	<input type="radio"/>
lan test_24_5	1	86%	WPA2-PSK	AES	02:50:48:56:79:15	<input type="radio"/>
lan test_24_7	1	86%	WPA2-PSK	AES	02:50:68:56:79:15	<input type="radio"/>

Once you selected an AP from the AP list, the channel, SSID, Authentication, Encryption, and MAC address will be automatically filled into the profile, you just have to enter a key for the uplink connection, if required.

# 4G LTE M2M Router

## 2.4 IPv6

The growth of the Internet has created a need for more addresses than are possible with IPv4. IPv6 (Internet Protocol version 6) is a version of the Internet Protocol (IP) intended to succeed IPv4, which is the protocol currently used to direct almost all Internet traffic. IPv6 also implements additional features not present in IPv4. It simplifies aspects of address assignment (stateless address auto-configuration), network renumbering and router announcements when changing Internet connectivity providers.

### 2.4.1 IPv6 Configuration

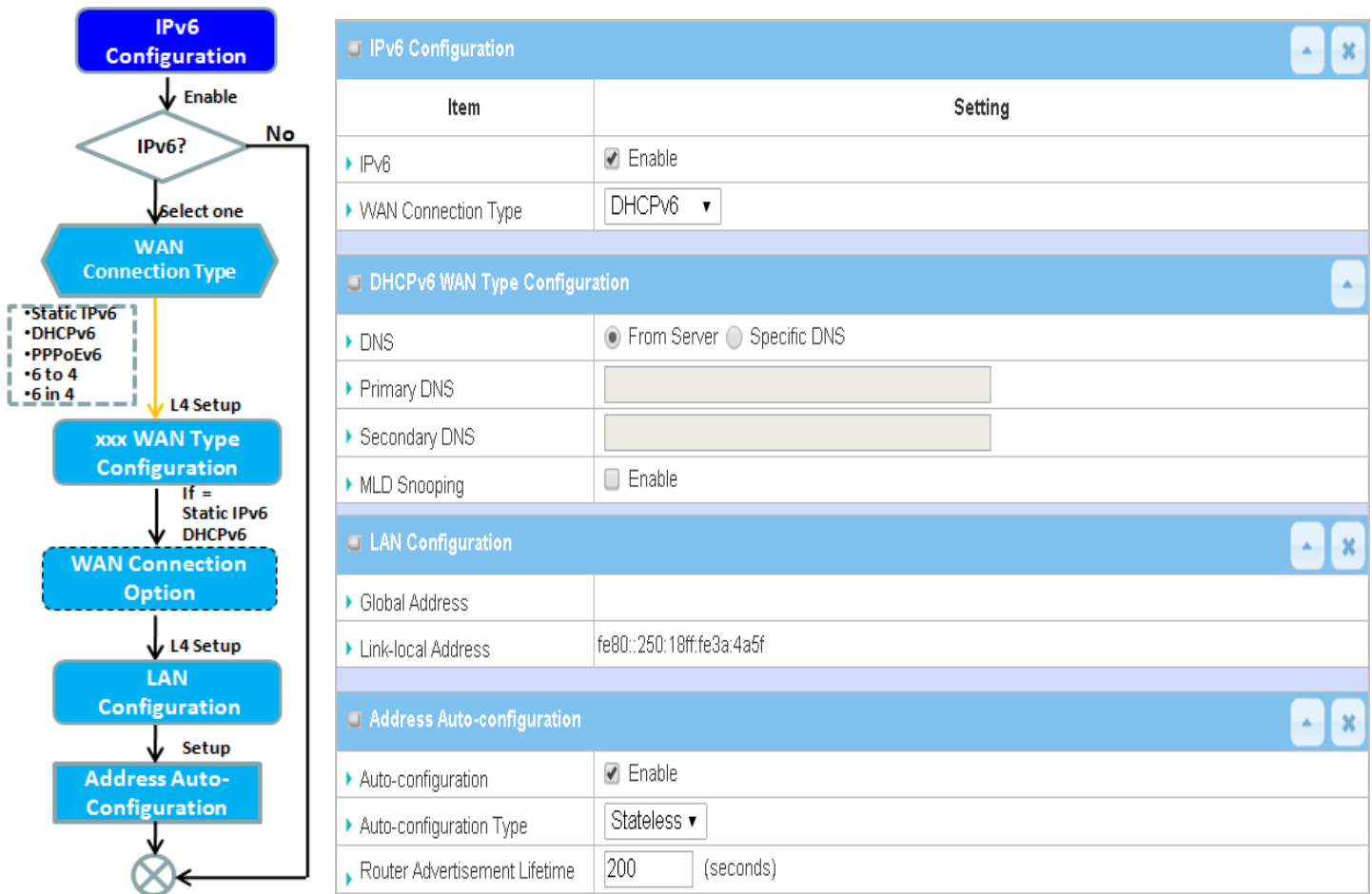

The **IPv6 Configuration** setting allows user to set the IPv6 connection type to access the IPv6 network. This gateway supports various types of IPv6 connection, including **Static IPv6**, **DHCPv6**, and **PPPoEv6**

**Note:** The available WAN connection types can be different, depending on the Interface type of WAN-1.

# 4G LTE M2M Router

## IPv6 WAN Connection Type

### Static IPv6

Static IPv6 does the same function as static IPv4. The static IPv6 provides manual setting of IPv6 address, IPv6 default gateway address, and IPv6 DNS.

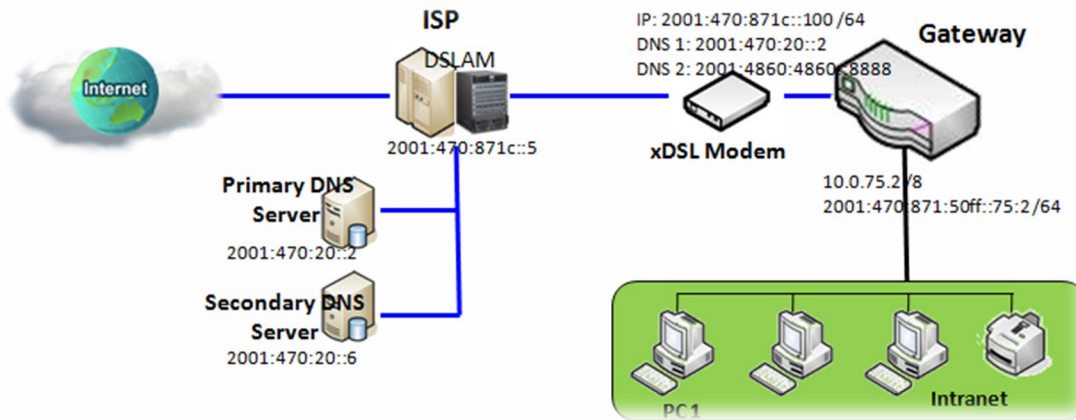

Above diagram depicts the IPv6 IP addressing, type in the information provided by your ISP to setup the IPv6 network.

### DHCPv6

DHCP in IPv6 does the same function as DHCP in IPv4. The DHCP server sends IP address, DNS server addresses and other possible data to the DHCP client to configure automatically. The server also sends a lease time of the address and time to re-contact the server for IPv6 address renewal. The client has then to resend a request to renew the IPv6 address.

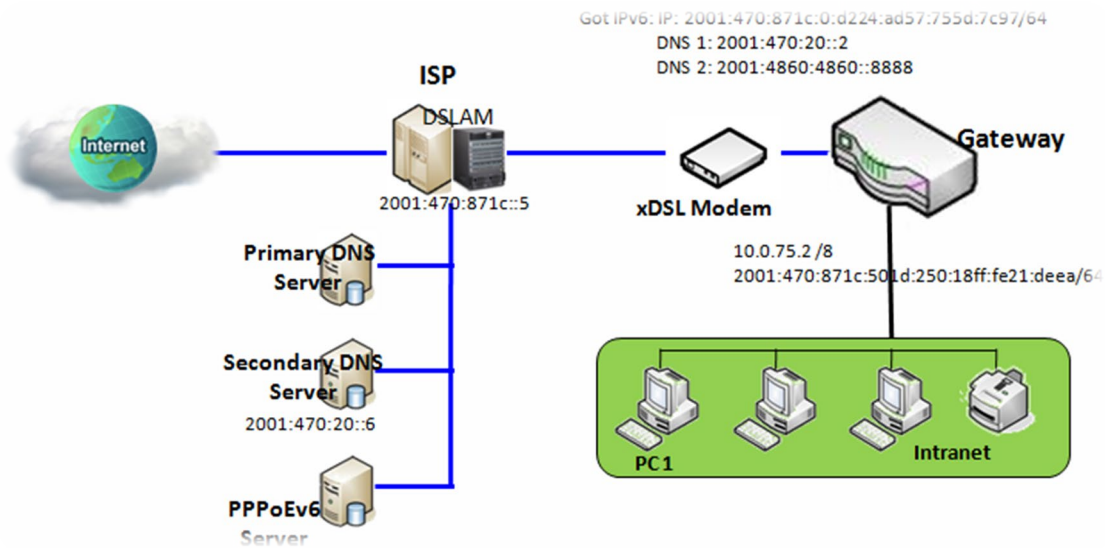

Above diagram depicts DHCP IPv6 IP addressing, the DHCPv6 server on the ISP side assigns IPv6 address, IPv6 default gateway address, and IPv6 DNS to client host's automatically.

# 4G LTE M2M Router

## PPPoEv6

PPPoEv6 in IPv6 does the same function as PPPoE in IPv4. The PPPoEv6 server provides configuration parameters based on PPPoEv6 client request. When PPPoEv6 server gets client request and successfully authenticates it, the server sends IP address, DNS server addresses and other required parameters to automatically configure the client.

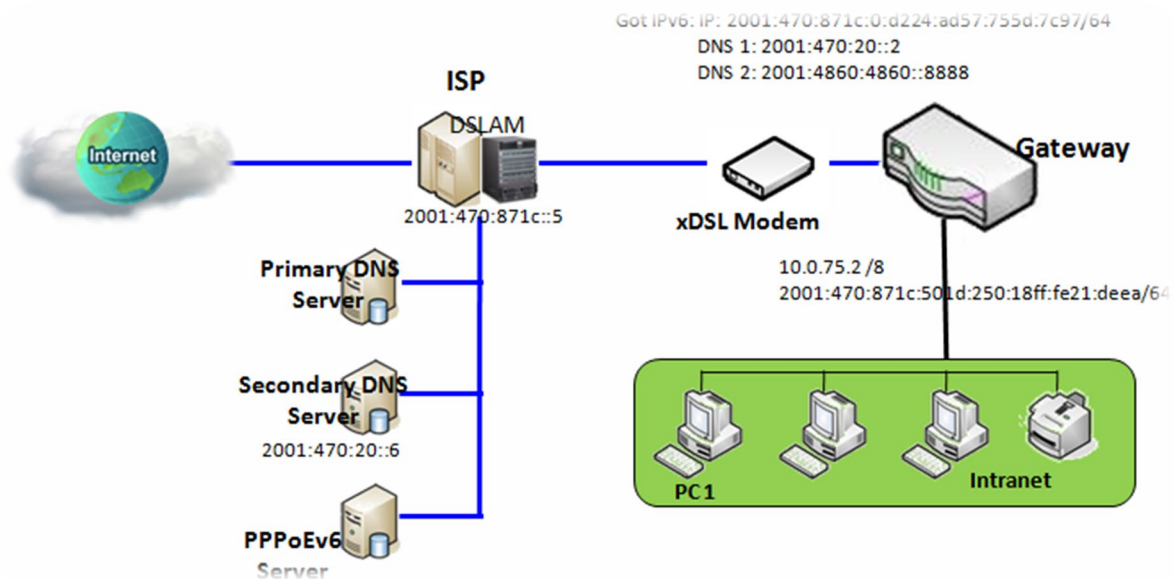

The diagram above depicts the IPv6 addressing through PPPoE, PPPoEv6 server (DSLAM) on the ISP side provides IPv6 configuration upon receiving PPPoEv6 client request. When PPPoEv6 server gets client request and successfully authenticates it, the server sends IP address, DNS server addresses and other required parameters to automatically configure the client.

# 4G LTE M2M Router

## IPv6 Configuration Setting

Go to **Basic Network > IPv6 > Configuration** Tab.

The **IPv6 Configuration** setting allows user to set the IPv6 connection type to access the IPv6 network.

IPv6 Configuration	
Item	Setting
▶ IPv6	<input checked="" type="checkbox"/> Enable
▶ WAN Connection Type	DHCPv6 ▼

Item	Value setting	Description
<b>IPv6</b>	The box is unchecked by default,	Check the <b>Enable</b> box to activate the IPv6 function.
<b>WAN Connection Type</b>	1. A Must filled setting 2. DHCPv6 is selected by default	Define the selected IPv6 WAN Connection Type to establish the IPv6 connectivity via WAN-1 Interface.  Select <b>Static IPv6</b> when your ISP provides you with a set IPv6 addresses. Select <b>DHCPv6</b> when your ISP provides you with DHCPv6 services. Select <b>PPPoEv6</b> when your ISP provides you with PPPoEv6 account settings.  <b>Note:</b> The available WAN connection types can be different, depending on the Interface type of WAN-1.

## Static IPv6 WAN Type Configuration

Static IPv6 WAN Type Configuration	
▶ IPv6 Address	<input type="text"/>
▶ Subnet Prefix Length	<input type="text"/>
▶ Default Gateway	<input type="text"/>
▶ Primary DNS	<input type="text"/>
▶ Secondary DNS	<input type="text"/>
▶ MLD Snooping	<input type="checkbox"/> Enable

Item	Value setting	Description
<b>IPv6 Address</b>	A Must filled setting	Enter the WAN <b>IPv6 Address</b> for the router.
<b>Subnet Prefix</b>	A Must filled setting	Enter the WAN <b>Subnet Prefix Length</b> for the router.

# 4G LTE M2M Router

Length		
<b>Default Gateway</b>	A Must filled setting	Enter the WAN <b>Default Gateway</b> IPv6 address.
<b>Primary DNS</b>	An optional setting	Enter the WAN <b>primary DNS Server</b> .
<b>Secondary DNS</b>	An optional setting	Enter the WAN <b>secondary DNS Server</b> .
<b>MLD Snooping</b>	The box is unchecked by default	Enable/Disable the MLD Snooping function

## LAN Configuration

LAN Configuration ▲ ✕

▶ Global Address	<input type="text"/>	/64
▶ Link-local Address	fe80::250:18ff:fe3a:4a5f	

LAN Configuration		
Item	Value setting	Description
<b>Global Address</b>	A Must filled setting	Enter the LAN <b>IPv6 Address</b> for the router.
<b>Link-local Address</b>	Value auto-created	Show the link-local address for LAN interface of router.

Then go to **Address Auto-configuration (summary)** for setting LAN environment.

If above setting is configured, click the **Save** button to save the configuration, and click the **Reboot** button to reboot the router.

# 4G LTE M2M Router

## DHCPv6 WAN Type Configuration

DHCPv6 WAN Type Configuration	
▶ DNS	<input checked="" type="radio"/> From Server <input type="radio"/> Specific DNS
▶ Primary DNS	<input type="text"/>
▶ Secondary DNS	<input type="text"/>
▶ MLD Snooping	<input type="checkbox"/> Enable

Item	Value setting	Description
<b>DNS</b>	The option [From Server] is selected by default	Select the [Specific DNS] option to active Primary DNS and Secondary DNS. Then fill the DNS information.
<b>Primary DNS</b>	Can not modified by default	Enter the WAN <b>primary DNS Server</b> .
<b>Secondary DNS</b>	Can not modified by default	Enter the WAN <b>secondary DNS Server</b> .
<b>MLD</b>	The box is unchecked by default	Enable/Disable the MLD Snooping function

## LAN Configuration

LAN Configuration	
▶ Global Address	<input type="text"/>
▶ Link-local Address	fe80::250:18ff:fe3a:4a5f

Item	Value setting	Description
<b>Global Address</b>	Value auto-created	Enter the LAN <b>IPv6 Address</b> for the router.
<b>Link-local Address</b>	Value auto-created	Show the link-local address for LAN interface of router.

Then go to **Address Auto-configuration (summary)** for setting LAN environment.

If above setting is configured, click the **Save** button to save the configuration, and click **Reboot** button to reboot the router.

# 4G LTE M2M Router

## PPPoEv6 WAN Type Configuration

PPPoEv6 WAN Type Configuration	
▶ Account	<input type="text" value="admin"/>
▶ Password	<input type="password" value="....."/>
▶ Service Name	<input type="text"/>
▶ Connection Control	Auto-reconnect (Always on)
▶ MTU	<input type="text"/>
▶ MLD Snooping	<input type="checkbox"/> Enable

Item	Value setting	Description
<b>Account</b>	A Must filled setting	Enter the Account for setting up PPPoEv6 connection. If you want more information, please contact your ISP. <b>Value Range:</b> 0 ~ 45 characters.
<b>Password</b>	A Must filled setting	Enter the Password for setting up PPPoEv6 connection. If you want more information, please contact your ISP.
<b>Service Name</b>	A Must filled setting/Option	Enter the Service Name for setting up PPPoEv6 connection. If you want more information, please contact your ISP. <b>Value Range:</b> 0 ~ 45 characters.
<b>Connection Control</b>	Fixed value	The value is <b>Auto-reconnect(Always on)</b> .
<b>MTU</b>	A Must filled setting	Enter the MTU for setting up PPPoEv6 connection. If you want more information, please contact your ISP. <b>Value Range:</b> 1280 ~ 1492.
<b>MLD Snooping</b>	The box is unchecked by default	Enable/Disable the MLD Snooping function

## LAN Configuration

LAN Configuration	
▶ Global Address	<input type="text"/>
▶ Link-local Address	fe80::250:18ff:fe3a:4a5f

Item	Value setting	Description
<b>Global Address</b>	Value auto-created	The LAN <b>IPv6 Address</b> for the router.
<b>Link-local Address</b>	Value auto-created	Show the link-local address for LAN interface of router.

Then go to **Address Auto-configuration (summary)** for setting LAN environment.

If above setting is configured, click the **save button** to save the configuration and click **reboot button** to reboot the router.

# 4G LTE M2M Router

Then go to **Address Auto-configuration (summary)** for setting LAN environment.

If above setting is configured, click the **save button** to save the configuration and click **reboot button** to reboot the router.

## Address Auto-configuration

Address Auto-configuration	
▶ Auto-configuration	<input checked="" type="checkbox"/> Enable
▶ Auto-configuration Type	Stateless ▾
▶ Router Advertisement Lifetime	<input type="text" value="200"/> (seconds)

Address Auto-configuration		
Item	Value setting	Description
<b>Auto-configuration</b>	The box is unchecked by default	Check to enable the Auto configuration feature.
<b>Auto-configuration Type</b>	<ol style="list-style-type: none"> <li>Only can be selected when <b>Auto-configuration</b> enabled</li> <li>Stateless is selected by default</li> </ol>	<p>Define the selected IPv6 WAN Connection Type to establish the IPv6 connectivity.</p> <p>Select <b>Stateless</b> to manage the Local Area Network to be SLAAC + RDNSS</p> <p><b>Router Advertisement Lifetime</b> (A Must filled setting): Enter the Router Advertisement Lifetime (in seconds). 200 is set by default. <i>Value Range:</i> 0 ~ 65535.</p> <p>Select <b>Stateful</b> to manage the Local Area Network to be <b>Stateful (DHCPv6)</b>.</p> <p><b>IPv6 Address Range (Start)</b> (A Must filled setting): Enter the start IPv6 Address for the DHCPv6 range for your local computers. 0100 is set by default. <i>Value Range:</i> 0001 ~ FFFF.</p> <p><b>IPv6 Address Range (End)</b> (A Must filled setting): Enter the end IPv6 Address for the DHCPv6 range for your local computers. 0200 is set by default. <i>Value Range:</i> 0001 ~ FFFF.</p> <p><b>IPv6 Address Lifetime</b> (A Must filled setting): Enter the DHCPv6 lifetime for your local computers. 36000 is set by default. <i>Value Range:</i> 0 ~ 65535.</p>

# 4G LTE M2M Router

## 2.5 Port Forwarding

Network address translation (NAT) is a methodology of remapping one IP address space into another by modifying network address information in Internet Protocol (IP) datagram packet headers while they are in transit across a traffic routing device. The technique was originally used for ease of rerouting traffic in IP networks without renumbering every host. It has become a popular and essential tool in conserving global address space allocations in face of IPv4 address exhaustion. The product you purchased embeds and activates the NAT function. You also can disable the NAT function in **[Basic Network]-[WAN & Uplink]-[Internet Setup]-[WAN Type Configuration]** page.

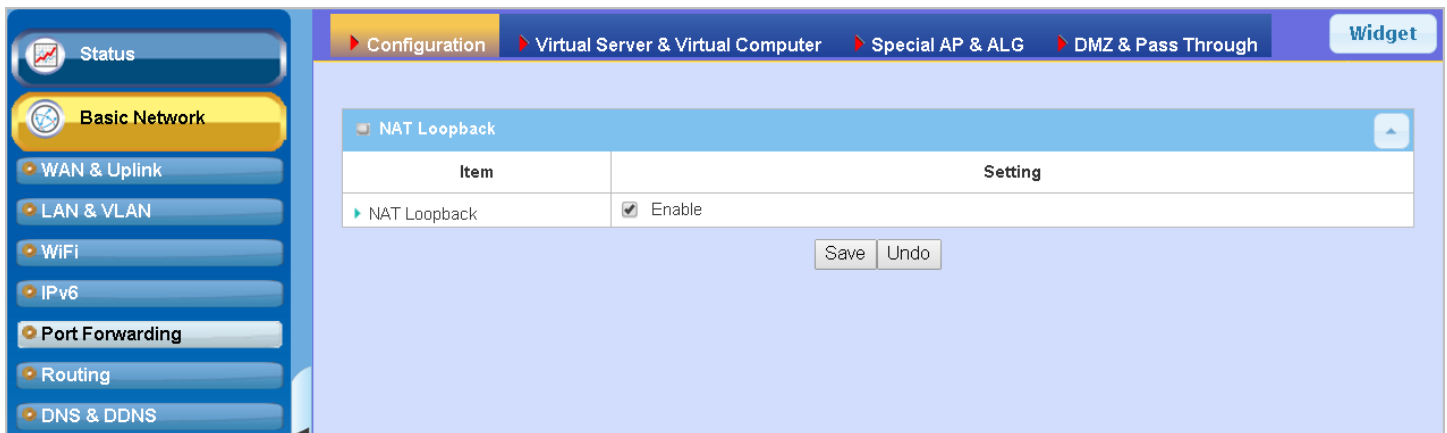

Usually all local hosts or servers behind corporate gateway are protected by NAT firewall. NAT firewall will filter out unrecognized packets to protect your Intranet. So, all local hosts are invisible to the outside world. Port forwarding or port mapping is function that redirects a communication request from one address and port number combination to assigned one. This technique is most commonly used to make services on a host residing on a protected or masqueraded (internal) network available to hosts on the opposite side of the gateway (external network), by remapping the destination IP address and port number

# 4G LTE M2M Router

## 2.5.1 Configuration

### [NAT Loopback](#)

This feature allows you to access the WAN global IP address from your inside NAT local network. It is useful when you run a server inside your network. For example, if you set a mail server at LAN side, your local devices can access this mail server through gateway's global IP address when enable NAT loopback feature. On either side are you in accessing the email server, at the LAN side or at the WAN side, you don't need to change the IP address of the mail server.

### [Configuration Setting](#)

---

Go to **Basic Network > Port Forwarding > Configuration** tab.

The NAT Loopback allows user to access the WAN IP address from inside your local network.

### Enable NAT Loopback

NAT Loopback	
Item	Setting
▶ NAT Loopback	<input checked="" type="checkbox"/> Enable

Configuration Item	Value setting	Description
<b>NAT Loopback</b>	The box is checked by default	Check the <b>Enable</b> box to activate this NAT function
<b>Save</b>	N/A	Click the <b>Save</b> button to save the settings.
<b>Undo</b>	N/A	Click the <b>Undo</b> button to cancel the settings

# 4G LTE M2M Router

## 2.5.2 Virtual Server & Virtual Computer

The screenshot displays the configuration interface of the 4G LTE M2M Router, divided into three main sections:

- Configuration:** A table with two columns: 'Item' and 'Setting'.

Item	Setting
Virtual Server	<input type="checkbox"/> Enable
Virtual Computer	<input checked="" type="checkbox"/> Enable
- Virtual Server List:** A table with columns: ID, WAN Interface, Server IP, Source IP, Protocol, Public Port, Private Port, Time Schedule, Enable, and Actions. It includes 'Add' and 'Delete' buttons.
- Virtual Computer List:** A table with columns: ID, Global IP, Local IP, Enable, and Actions. It includes 'Add' and 'Delete' buttons.

There are some important Port Forwarding functions implemented within the gateway, including "Virtual Server", "NAT loopback" and "Virtual Computer".

It is necessary for cooperate staffs who travel outside and want to access various servers behind office gateway. You can set up those servers by using "Virtual Server" feature. After trip, if want to access those servers from LAN side by global IP, without change original setting, NAT Loopback can achieve it.

"Virtual computer" is a host behind NAT gateway whose IP address is a global one and is visible to the outside world. Since it is behind NAT, it is protected by gateway firewall. To configure Virtual Computer, you just have to map the local IP of the virtual computer to a global IP.

# 4G LTE M2M Router

## Virtual Server & NAT Loopback

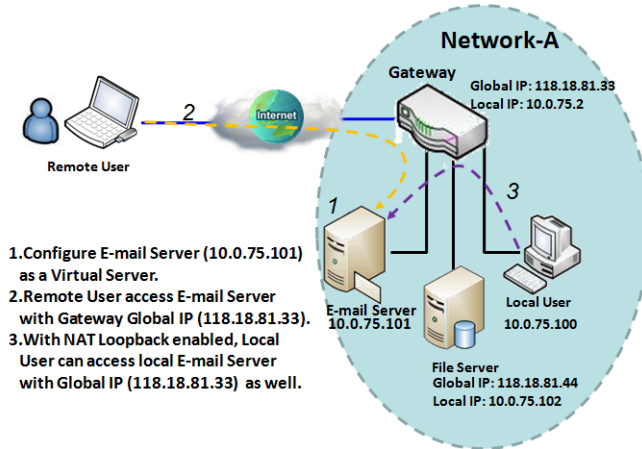

"Virtual Server" allows you to access servers with the global IP address or FQDN of the gateway as if they are servers existed in the Internet. But in fact, these servers are located in the Intranet and are physically behind the gateway. The gateway serves the service requests by port forwarding the requests to the LAN servers and transfers the replies from LAN servers to the requester on the WAN side. As shown in example, an E-mail virtual server is defined to be located at a server with IP address 10.0.75.101 in the Intranet of Network-A, including SMTP service port 25 and POP3 service port 110. So, the remote user can access the E-mail server with the

gateway's global IP 118.18.81.33 from its WAN side. But the real E-mail server is located at LAN side and the gateway is the port forwarder for E-mail service.

NAT Loopback allows you to access the WAN global IP address from your inside NAT local network. It is useful when you run a server inside your network. For example, if you set a mail server at LAN side, your local devices can access this mail server through gateway's global IP address when enable NAT loopback feature. On either side are you in accessing the email server, at the LAN side or at the WAN side, you don't need to change the IP address of the mail server.

## Virtual Computer

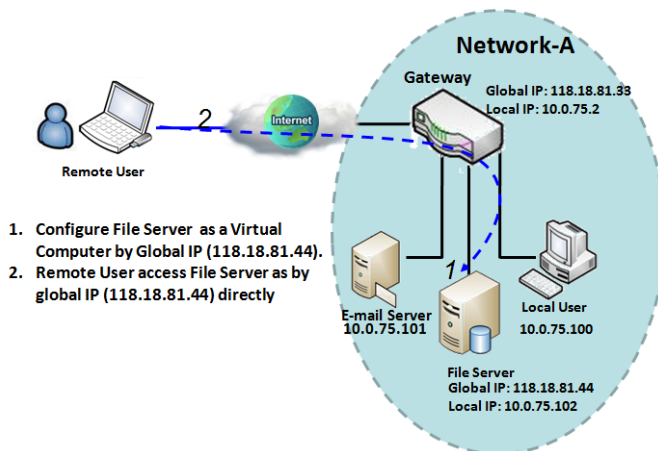

"Virtual Computer" allows you to assign LAN hosts to global IP addresses, so that they can be visible to outside world. While so, they are also protected by the gateway firewall as being client hosts in the Intranet. For example, if you set a FTP file server at LAN side with local IP address 10.0.75.102 and global IP address 118.18.82.44, a remote user can access the file server while it is hidden behind the NAT gateway. That is because the gateway takes care of all accessing to the IP address 118.18.82.44, including to forward the access requests to the file server and to send the replies from the server to outside world.

# 4G LTE M2M Router

## Virtual Server & Virtual Computer Setting

Go to **Basic Network > Port Forwarding > Virtual Server & Virtual Computer** tab.

### Enable Virtual Server and Virtual Computer

Configuration	
Item	Setting
Virtual Server	<input type="checkbox"/> Enable
Virtual Computer	<input checked="" type="checkbox"/> Enable

Configuration Item	Value setting	Description
<b>Virtual Server</b>	The box is unchecked by default	Check the <b>Enable</b> box to activate this port forwarding function
<b>Virtual Computer</b>	The box is checked by default	Check the <b>Enable</b> box to activate this port forwarding function
<b>Save</b>	N/A	Click the <b>Save</b> button to save the settings.
<b>Undo</b>	N/A	Click the <b>Undo</b> button to cancel the settings.

### Create / Edit Virtual Server

The gateway allows you to custom your Virtual Server rules. It supports up to a maximum of 20 rule-based Virtual Server sets.

Virtual Server List									
ID	WAN Interface	Server IP	Source IP	Protocol	Public Port	Private Port	Time Schedule	Enable	Actions

When **Add** button is applied, **Virtual Server Rule Configuration** screen will appear.

# 4G LTE M2M Router

Virtual Server Rule Configuration	
Item	Setting
▶ WAN Interface	<input checked="" type="checkbox"/> All <input type="checkbox"/> WAN-1 <input type="checkbox"/> WAN-2 <input type="checkbox"/> WAN-3
▶ Server IP	<input type="text"/>
▶ Source IP	Any ▾
▶ Protocol	TCP(6) & UDP(17) ▾
▶ Public Port	Single Port ▾ <input type="text"/>
▶ Private Port	Single Port ▾ <input type="text"/>
▶ Time Schedule	(0) Always ▾
▶ Rule	<input type="checkbox"/> Enable

Virtual Server Rule Configuration		
Item	Value setting	Description
<b>WAN Interface</b>	<ol style="list-style-type: none"> <li>1. A Must filled setting</li> <li>2. Default is <b>ALL</b>.</li> </ol>	<p>Define the selected interface to be the packet-entering interface of the gateway.</p> <p>If the packets to be filtered are coming from <b>WAN-x</b> then select <b>WAN-x</b> for this field.</p> <p>Select <b>ALL</b> for packets coming into the gateway from any interface. It can be selected <b>WAN-x</b> box when <b>WAN-x</b> enabled.</p> <p><b>Note:</b> The available check boxes (<b>WAN-1 ~ WAN-4</b>) depend on the number of WAN interfaces for the product.</p>
<b>Server IP</b>	A Must filled setting	This field is to specify the IP address of the interface selected in the WAN Interface setting above.
<b>Source IP</b>	<ol style="list-style-type: none"> <li>1. A Must filled setting</li> <li>2. By default <b>Any</b> is selected</li> </ol>	<p>This field is to specify the <b>Source IP address</b>.</p> <p>Select <b>Any</b> to allow the access coming from any IP addresses.</p> <p>Select <b>Specific IP Address</b> to allow the access coming from an IP address.</p> <p>Select <b>IP Range</b> to allow the access coming from a specified range of IP address.</p>
<b>Protocol</b>	<ol style="list-style-type: none"> <li>1. A Must filled setting</li> <li>2. <b>TCP &amp; UDP</b> is selected by default.</li> </ol>	<p>When "<b>ICMPv4</b>" is selected It means the option "Protocol" of packet filter rule is ICMPv4. Apply <b>Time Schedule</b> to this rule, otherwise leave it as <b>Always</b>. (refer to <b>Scheduling setting</b> under <b>Object Definition</b>) Then check <b>Enable</b> box to enable this rule.</p> <p>When "<b>TCP</b>" is selected It means the option "Protocol" of packet filter rule is TCP. <b>Public Port</b> selected a predefined port from <b>Well-known Service</b>, and <b>Private Port</b> is the same with <b>Public Port</b> number. <b>Public Port</b> is selected <b>Single Port</b> and specify a port number, and <b>Private Port</b> can be set a <b>Single Port</b> number. <b>Public Port</b> is selected <b>Port Range</b> and specify a port range, and <b>Private Port</b> can be selected <b>Single Port</b> or <b>Port Range</b>. <i>Value Range:</i> 1 ~ 65535 for Public Port, Private Port.</p>

# 4G LTE M2M Router

When “**UDP**” is selected

It means the option “Protocol” of packet filter rule is UDP.

**Public Port** selected a predefined port from **Well-known Service**, and **Private Port** is the same with **Public Port** number.

**Public Port** is selected **Single Port** and specify a port number, and **Private Port** can be set a **Single Port** number.

**Public Port** is selected **Port Range** and specify a port range, and **Private Port** can be selected **Single Port** or **Port Range**.

*Value Range:* 1 ~ 65535 for Public Port, Private Port.

When “**TCP & UDP**” is selected

It means the option “Protocol” of packet filter rule is TCP and UDP.

**Public Port** selected a predefined port from **Well-known Service**, and **Private Port** is the same with **Public Port** number.

**Public Port** is selected **Single Port** and specify a port number, and **Private Port** can be set a **Single Port** number.

**Public Port** is selected **Port Range** and specify a port range, and **Private Port** can be selected **Single Port** or **Port Range**.

*Value Range:* 1 ~ 65535 for Public Port, Private Port.

When “**GRE**” is selected

It means the option “Protocol” of packet filter rule is GRE.

When “**ESP**” is selected

It means the option “Protocol” of packet filter rule is ESP.

When “**SCTP**” is selected

It means the option “Protocol” of packet filter rule is SCTP.

When “**User-defined**” is selected

It means the option “Protocol” of packet filter rule is User-defined.

For **Protocol Number**, enter a port number.

<b>Time Schedule</b>	1. An optional filled setting 2. <b>(0) Always</b> Is selected by default.	Apply Time Schedule to this rule; otherwise leave it as (0) Always. (refer to Scheduling setting under Object Definition)
<b>Rule</b>	1. An optional filled setting 2. The box is unchecked by default.	Check the Enable box to activate the rule.
<b>Save</b>	N/A	Click the <b>Save</b> button to save the settings.
<b>Undo</b>	N/A	Click the <b>X</b> button to cancel the settings and return to previous page.

# 4G LTE M2M Router

## Create / Edit Virtual Computer

The gateway allows you to custom your Virtual Computer rules. It supports up to a maximum of 20 rule-based Virtual Computer sets.

Virtual Computer List				
ID	Global IP	Local IP	Enable	Actions

When **Add** button is applied, **Virtual Computer Rule Configuration** screen will appear.

Virtual Computer Rule Configuration		
Global IP	Local IP	Enable
<input type="text"/>	<input type="text"/>	<input type="checkbox"/>

Virtual Computer Rule Configuration		
Item	Value setting	Description
<b>Global IP</b>	A Must filled setting	This field is to specify the IP address of the WAN IP.
<b>Local IP</b>	A Must filled setting	This field is to specify the IP address of the LAN IP.
<b>Enable</b>	N/A	Then check <b>Enable</b> box to enable this rule.
<b>Save</b>	N/A	Click the <b>Save</b> button to save the settings.

# 4G LTE M2M Router

## 2.5.3 DMZ & Pass Through

DMZ (De Militarized Zone) Host is a host that is exposed to the Internet cyberspace but still within the protection of firewall by gateway device. So, the function allows a computer to execute 2-way communication for Internet games, Video conferencing, Internet telephony and other special applications. In some cases when a specific application is blocked by NAT mechanism, you can indicate that LAN computer as a DMZ host to solve this problem.

The DMZ function allows you to ask the gateway pass through all normal packets to the DMZ host behind the NAT gateway only when these packets are not expected to receive by applications in the gateway or by other client hosts in the Intranet. Certainly, the DMZ host is also protected by the gateway firewall. Activate the feature and specify the DMZ host with a host in the Intranet when needed.

Configuration	
Item	Setting
DMZ	<input checked="" type="checkbox"/> Enable <input checked="" type="checkbox"/> All <input type="checkbox"/> WAN-1 <input type="checkbox"/> WAN-2 <input type="checkbox"/> WAN-3 <input type="checkbox"/> WAN-4 DMZ Host: <input type="text" value="10.0.75.100"/>
Pass Through Enable	<input checked="" type="checkbox"/> IPSec <input checked="" type="checkbox"/> PPTP <input checked="" type="checkbox"/> L2TP

### DMZ Scenario

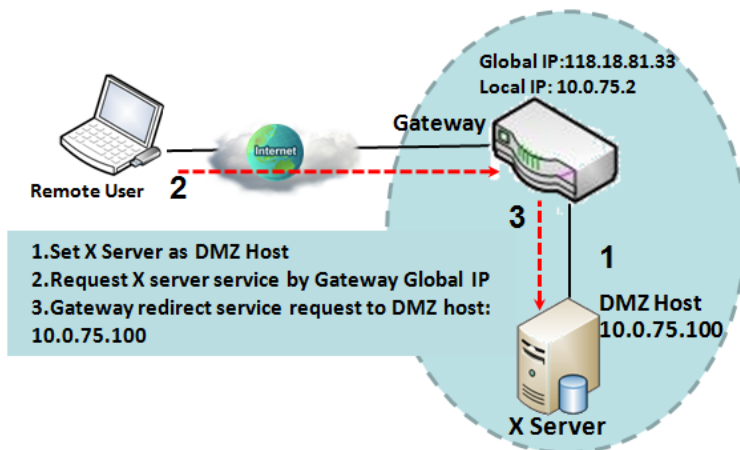

When the network administrator wants to set up some service daemons in a host behind NAT gateway to allow remote users request for services from server actively, you just have to configure this host as DMZ Host. As shown in the diagram, there is an X server installed as DMZ host, whose IP address is 10.0.75.100. Then, remote user can request services from X server just as it is provided by the gateway whose global IP address is 118.18.81.33. The gateway will forward those packets, not belonging to any configured virtual server or applications, directly to the DMZ host.

# 4G LTE M2M Router

## VPN Pass through Scenario

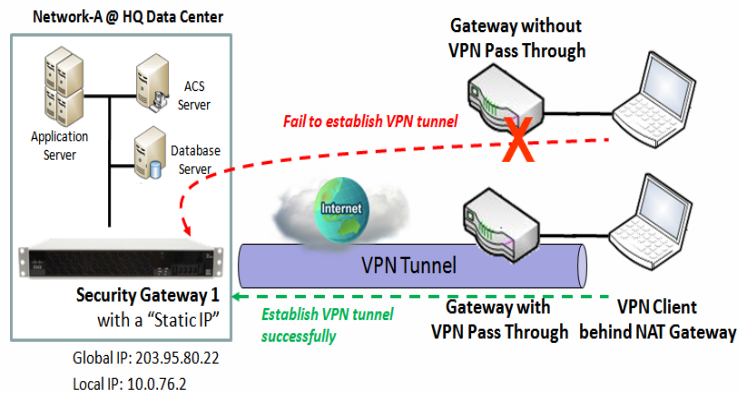

Since VPN traffic is different from that of TCP or UDP connection, it will be blocked by NAT gateway. To support the pass through function for the VPN connections initiating from VPN clients behind NAT gateway, the gateway must implement some kind of VPN pass through function for such application. The gateway support the pass through function for IPSec, PPTP, and L2TP connections, you just have to check the corresponding checkbox to activate it.

## DMZ & Pass Through Setting

Go to **Basic Network > Port Forwarding > DMZ & Pass Through** tab.

The DMZ host is a host that is exposed to the Internet cyberspace but still within the protection of firewall by gateway device.

### Enable DMZ and Pass Through

Configuration	
Item	Setting
DMZ	<input type="checkbox"/> Enable <input checked="" type="checkbox"/> All <input type="checkbox"/> WAN-1 <input type="checkbox"/> WAN-2 <input type="checkbox"/> WAN-3 <input type="checkbox"/> WAN-4 DMZ Host: <input type="text"/>
Pass Through Enable	<input checked="" type="checkbox"/> IPSec <input checked="" type="checkbox"/> PPTP <input checked="" type="checkbox"/> L2TP

Configuration Item	Value setting	Description
<b>DMZ</b>	1. A Must filled setting 2. Default is <b>ALL</b> .	Check the <b>Enable</b> box to activate the DMZ function Define the selected interface to be the packet-entering interface of the gateway, and fill in the IP address of Host LAN IP in <b>DMZ Host</b> field . If the packets to be filtered are coming from <b>WAN-x</b> then select <b>WAN-x</b> for this field. Select <b>ALL</b> for packets coming into the router from any interfaces. It can be selected <b>WAN-x</b> box when <b>WAN-x</b> enabled.

# 4G LTE M2M Router

		<b>Note:</b> The available check boxes ( <b>WAN-1 ~ WAN-4</b> ) depend on the number of WAN interfaces for the product.
<b>Pass Through Enable</b>	The boxes are checked by default	Check the box to enable the pass through function for the <b>IPSec</b> , <b>PPTP</b> , and <b>L2TP</b> . With the pass through function enabled, the VPN hosts behind the gateway still can connect to remote VPN servers.
<b>Save</b>	N/A	Click the <b>Save</b> button to save the settings.
<b>Undo</b>	N/A	Click the <b>Undo</b> button to cancel the settings

# 4G LTE M2M Router

## 2.6 Routing

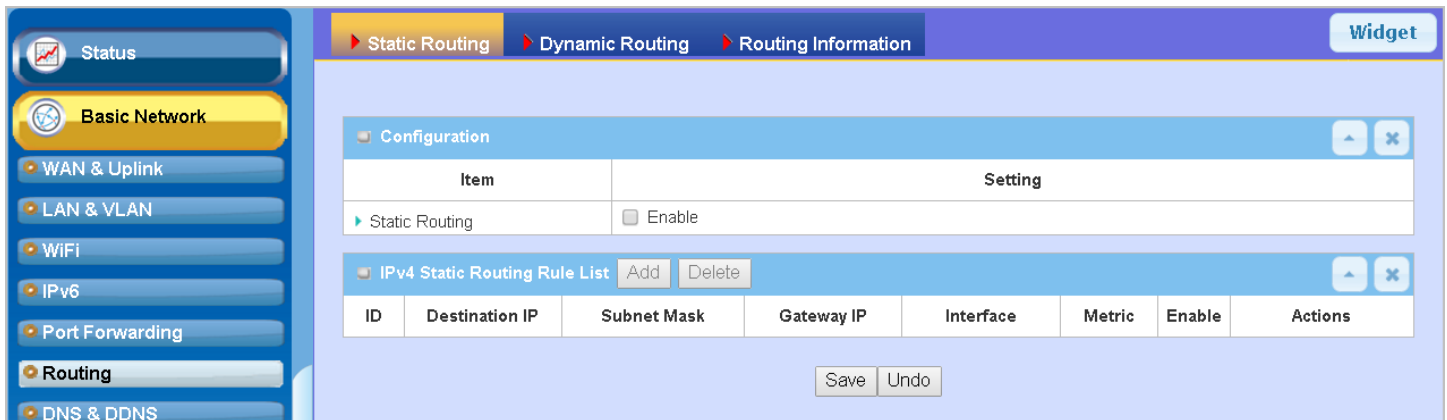

If you have more than one router and subnet, you will need to enable routing function to allow packets to find proper routing path and allow different subnets to communicate with each other. Routing is the process of selecting best paths in a network. It is performed for many kinds of networks, like electronic data networks (such as the Internet), by using packet switching technology. The routing process usually directs forwarding on the basis of routing tables which maintain a record of the routes to various network destinations. Thus, constructing routing tables, which are held in the router's memory, is very important for efficient routing. Most routing algorithms use only one network path at a time.

The routing tables record your pre-defined routing paths for some specific destination subnets. It is **static routing**. However, if the contents of routing tables record the obtained routing paths from neighbor routers by using some protocols, such as RIP, OSPF and BGP. It is **dynamic routing**. These both routing approaches will be illustrated one after one. In addition, the gateway also built in one advanced configurable routing software Quagga for more complex routing applications, you can configure it if required via Telnet CLI.

# 4G LTE M2M Router

## 2.6.1 Static Routing

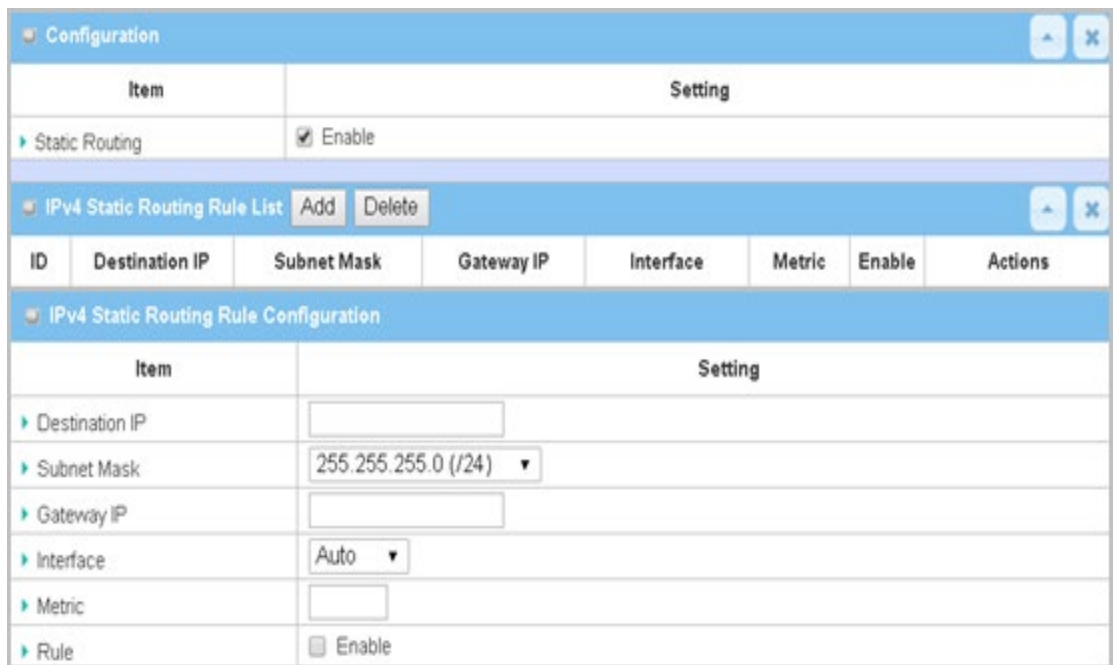
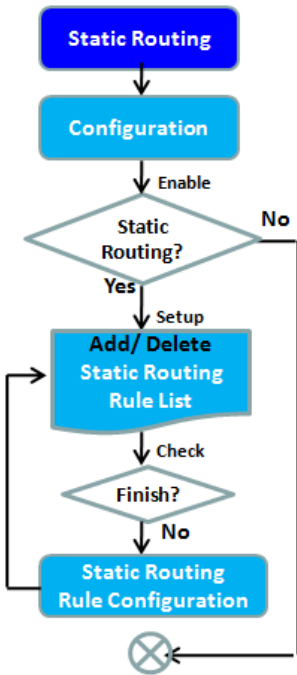

"Static Routing" function lets you define the routing paths for some dedicated hosts/servers or subnets to store in the routing table of the gateway. The gateway routes incoming packets to different peer gateways based on the routing table. You need to define the static routing information in gateway routing rule list.

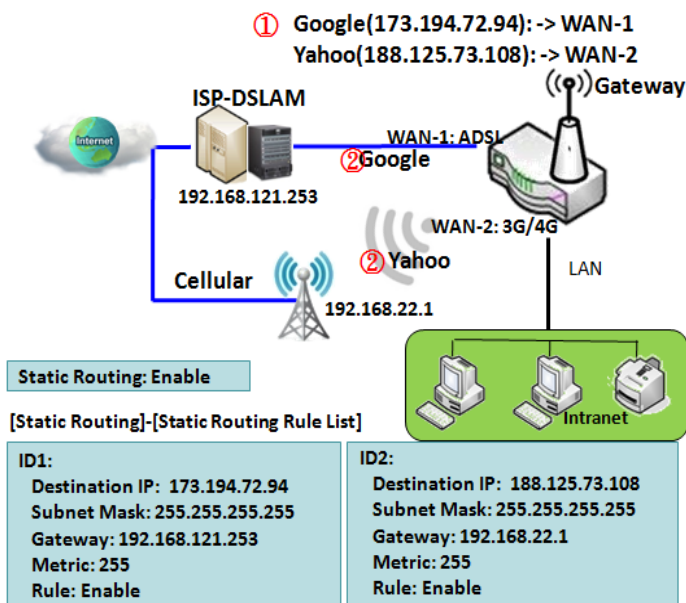

When the administrator of the gateway wants to specify what kinds of packets to be transferred via which gateway interface and which peer gateway to their destination. It can be carried out by the "Static Routing" feature. Dedicated packet flows from the Intranet will be routed to their destination via the pre-defined peer gateway and corresponding gateway interface that are defined in the system routing table by manual.

As shown in the diagram, when the destination is Google access, rule 1 set interface as ADSL, routing gateway as IP-DSLAM gateway 192.168.121.253. All the packets to Google will go through WAN-1. And the same way applied to rule 2 of access Yahoo. Rule 2 sets 3G/4G as interface.

# 4G LTE M2M Router

## Static Routing Setting

Go to **Basic Network > Routing > Static Routing** Tab.

There are three configuration windows for static routing feature, including "Configuration", "Static Routing Rule List" and "Static Routing Rule Configuration" windows. "Configuration" window lets you activate the global static routing feature. Even there are already routing rules, if you want to disable routing temporarily, just uncheck the Enable box to disable it. "Static Routing Rule List" window lists all your defined static routing rule entries. Using "Add" or "Edit" button to add and create one new static routing rule or to modify an existed one.

When "**Add**" or "**Edit**" button is applied, the "Static Routing Rule Configuration" window will appear to let you define a static routing rule.

### Enable Static Routing

Just check the **Enable** box to activate the "Static Routing" feature.



Item	Setting
Static Routing	<input checked="" type="checkbox"/> Enable

Static Routing Item	Value setting	Description
Static Routing	The box is unchecked by default	Check the <b>Enable</b> box to activate this function

### Create / Edit Static Routing Rules

The Static Routing Rule List shows the setup parameters of all static routing rule entries. To configure a static routing rule, you must specify related parameters including the destination IP address and subnet mask of dedicated host/server or subnet, the IP address of peer gateway, the metric and the rule activation.



ID	Destination IP	Subnet Mask	Gateway IP	Interface	Metric	Enable	Actions
----	----------------	-------------	------------	-----------	--------	--------	---------

The gateway allows you to custom your static routing rules. It supports up to a maximum of 64 rule sets. When **Add** button is applied, **Static Routing Rule Configuration** screen will appear, while the **Edit** button at the end

# 4G LTE M2M Router

of each static routing rule can let you modify the rule.

IPv4 Static Routing Rule Configuration	
Item	Setting
▶ Destination IP	<input type="text"/>
▶ Subnet Mask	255.255.255.0 (/24) ▼
▶ Gateway IP	<input type="text"/>
▶ Interface	Auto ▼
▶ Metric	<input type="text"/>
▶ Rule	<input type="checkbox"/> Enable

IPv4 Static Routing		
Item	Value setting	Description
Destination IP	1. IPv4 Format 2. A Must filled setting	Specify the Destination IP of this static routing rule.
Subnet Mask	255.255.255.0 (/24) is set by default	Specify the Subnet Mask of this static routing rule.
Gateway IP	1. IPv4 Format 2. A Must filled setting	Specify the Gateway IP of this static routing rule.
Interface	Auto is set by default	Select the Interface of this static routing rule. It can be <b>Auto</b> , or the available WAN / LAN interfaces.
<b>Metric</b>	1. Numeric String Format 2. A Must filled setting	The Metric of this static routing rule. <i>Value Range: 0 ~ 255.</i>
<b>Rule</b>	The box is unchecked by default.	Click <b>Enable</b> box to activate this rule.
<b>Save</b>	NA	Click the <b>Save</b> button to save the configuration
<b>Undo</b>	NA	Click the <b>Undo</b> button to restore what you just configured back to the previous setting.
<b>Back</b>	NA	When the <b>Back</b> button is clicked the screen will return to the Static Routing Configuration page.

# 4G LTE M2M Router

## 2.6.2 Dynamic Routing

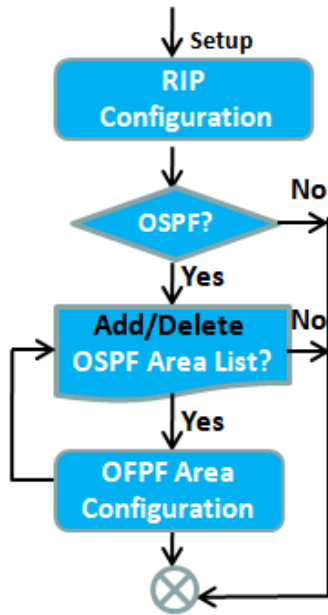

RIP Configuration	
Item	Setting
▶ RIP Enable	Disable ▾

OSPF Configuration	
Item	Setting
▶ OSPF	<input type="checkbox"/> Enable
▶ Router ID	<input type="text"/>
▶ Authentication	None ▾
▶ Backbone Subnet	<input type="text"/>

OSPF Area List				
ID	Area Subnet	Area ID	Enable	Actions

BGP Configuration	
Item	Setting
▶ BGP	<input type="checkbox"/> Enable
▶ ASN	<input type="text"/>
▶ Router ID	<input type="text"/>

Dynamic Routing, also called adaptive routing, describes the capability of a system, through which routes are characterized by their destination, to alter the path that the route takes through the system in response to a change in network conditions.

This gateway supports dynamic routing protocols, including RIPv1/RIPv2 (Routing Information Protocol), and OSPF (Open Shortest Path First), for you to establish routing table automatically. The feature of dynamic routing will be very useful when there are lots of subnets in your network. Generally speaking, RIP is suitable for small network. OSPF is more suitable for medium network.

The supported dynamic routing protocols are described as follows.

# 4G LTE M2M Router

## RIP Scenario

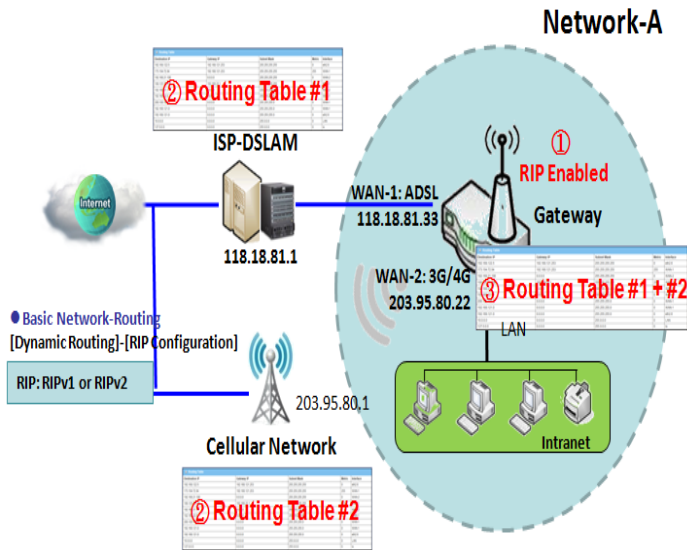

The Routing Information Protocol (RIP) is one of the oldest distance-vector routing protocols, which employs the hop count as a routing metric. RIP prevents routing loops by implementing a limit on the number of hops allowed in a path from the source to a destination. The maximum number of hops allowed for RIP is 15. This hop limit, however, also limits the size of networks that RIP can support. A hop count of 16 is considered an infinite distance, in other words the route is considered unreachable. RIP implements the split horizon, route poisoning and hold-down mechanisms to prevent incorrect routing information from being propagated.

## OSPF Scenario

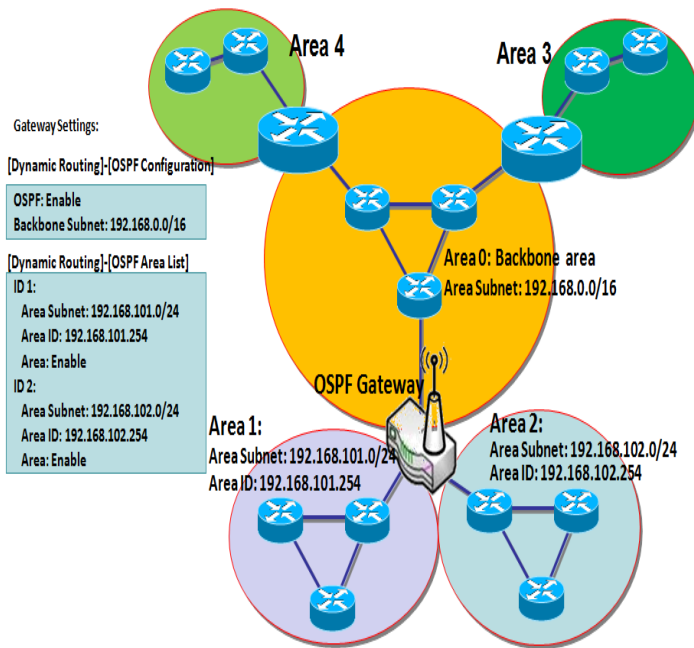

Open Shortest Path First (OSPF) is a routing protocol that uses link state routing algorithm. It is the most widely used interior gateway protocol (IGP) in large enterprise networks. It gathers link state information from available routers and constructs a topology map of the network. The topology is presented as a routing table which routes datagrams based solely on the destination IP address.

Network administrator can deploy OSPF gateway in large enterprise network to get its routing table from the enterprise backbone, and forward routing information to other routers, which are not linked to the enterprise backbone. Usually, an OSPF network is subdivided into routing areas to simplify administration and optimize traffic and resource utilization.

As shown in the diagram, OSPF gateway gathers routing information from the backbone gateways in area 0, and will forward its routing information to the routers in area 1 and area 2 which are not in the backbone.

# 4G LTE M2M Router

## Dynamic Routing Setting

Go to **Basic Network > Routing > Dynamic Routing** Tab.

The dynamic routing setting allows user to customize RIP, and OSPF protocols through the router based on their office setting.

In the "Dynamic Routing" page, there are several configuration windows for dynamic routing feature. They are the "RIP Configuration" window, "OSPF Configuration" window, "OSPF Area List", and "OSPF Area Configuration" window. RIP, and OSPF protocols can be configured individually.

The "RIP Configuration" window lets you choose which version of RIP protocol to be activated or disable it. The "OSPF Configuration" window can let you activate the OSPF dynamic routing protocol and specify its backbone subnet. Moreover, the "OSPF Area List" window lists all defined areas in the OSPF network.

### RIP Configuration

The RIP configuration setting allows user to customize RIP protocol through the router based on their office setting.



Item	Setting
▶ RIP Enable	Disable

Item	Value setting	Description
<b>RIP Enable</b>	Disable is set by default	Select <b>Disable</b> will disable RIP protocol. Select <b>RIP v1</b> will enable RIPv1 protocol. Select <b>RIP v2</b> will enable RIPv2 protocol.

### OSPF Configuration

The OSPF configuration setting allows user to customize OSPF protocol through the router based on their office setting.

# 4G LTE M2M Router

OSPF Configuration	
Item	Setting
▶ OSPF	<input type="checkbox"/> Enable
▶ Router ID	<input type="text"/>
▶ Authentication	None ▾
▶ Backbone Subnet	<input type="text"/>

OSPF Configuration		
Item	Value setting	Description
<b>OSPF</b>	Disable is set by default	Click <b>Enable</b> box to activate the OSPF protocol.
<b>Router ID</b>	1. IPv4 Format 2. A Must filled setting	The Router ID of this router on OSPF protocol
<b>Authentication</b>	None is set by default	The Authentication method of this router on OSPF protocol. Select <b>None</b> will disable Authentication on OSPF protocol. Select <b>Text</b> will enable Text Authentication with entered the Key in this field on OSPF protocol. Select <b>MD5</b> will enable MD5 Authentication with entered the ID and Key in these fields on OSPF protocol.
<b>Backbone Subnet</b>	1. Classless Inter Domain Routing (CIDR) Subnet Mask Notation. (Ex: 192.168.1.0/24) 2. A Must filled setting	The Backbone Subnet of this router on OSPF protocol.

## Create / Edit OSPF Area Rules

The gateway allows you to custom your OSPF Area List rules. It supports up to a maximum of 32 rule sets.

OSPF Area List <span>Add</span> <span>Delete</span>				
ID	Area Subnet	Area ID	Enable	Actions

When **Add** button is applied, **OSPF Area Rule Configuration** screen will appear.

# 4G LTE M2M Router

OSPF Area Configuration	
Item	Setting
▶ Area Subnet	<input type="text"/>
▶ Area ID	<input type="text"/>
▶ Area	<input type="checkbox"/> Enable
<input type="button" value="Save"/>	

OSPF Area Configuration		
Item	Value setting	Description
<b>Area Subnet</b>	1. Classless Inter Domain Routing (CIDR) Subnet Mask Notation. (Ex: 192.168.1.0/24) 2. A Must filled setting	The Area Subnet of this router on OSPF Area List.
<b>Area ID</b>	1. IPv4 Format 2. A Must filled setting	The Area ID of this router on OSPF Area List.
<b>Area</b>	The box is unchecked by default.	Click <b>Enable</b> box to activate this rule.
<b>Save</b>	N/A	Click the <b>Save</b> button to save the configuration

# 4G LTE M2M Router

## 2.6.3 Routing Information

The routing information allows user to view the routing table and policy routing information. Policy Routing Information is only available when the Load Balance function is enabled and the Load Balance Strategy is By User Policy.

Go to **Basic Network > Routing > Routing Information** Tab.

Routing Table				
Destination IP	Subnet Mask	Gateway IP	Metric	Interface
100.105.167.72	255.255.255.252	0.0.0.0	0	WAN-2
192.168.66.0	255.255.255.0	0.0.0.0	0	LAN
192.168.127.0	255.255.255.0	0.0.0.0	0	WAN-1
169.254.0.0	255.255.0.0	0.0.0.0	0	LAN
127.0.0.0	255.0.0.0	0.0.0.0	0	lo

Routing Table		
Item	Value setting	Description
Destination IP	N/A	Routing record of Destination IP. IPv4 Format.
Subnet Mask	N/A	Routing record of Subnet Mask. IPv4 Format.
Gateway IP	N/A	Routing record of Gateway IP. IPv4 Format.
Metric	N/A	Routing record of Metric. Numeric String Format.
Interface	N/A	Routing record of Interface Type. String Format.

Policy Routing Information				
Policy Routing Source	Source IP	Destination IP	Destination Port	WAN Interface
Load Balance	-	-	-	-

Policy Routing Information		
Item	Value setting	Description
Policy Routing Source	N/A	Policy Routing of Source. String Format.
Source IP	N/A	Policy Routing of Source IP. IPv4 Format.
Destination IP	N/A	Policy Routing of Destination IP. IPv4 Format.
Destination Port	N/A	Policy Routing of Destination Port. String Format.
WAN Interface	N/A	Policy Routing of WAN Interface. String Format.

# 4G LTE M2M Router

## 2.7 DNS & DDNS

How does user access your server if your WAN IP address changes all the time? One way is to register a new domain name, and maintain your own DNS server. Another simpler way is to apply a domain name to a third-party DDNS service provider. The service can be free or charged. If you want to understand the basic concepts of DNS and Dynamic DNS, you can refer to Wikipedia website<sup>4,5</sup>.

### 2.7.1 DNS & DDNS Configuration

#### Dynamic DNS

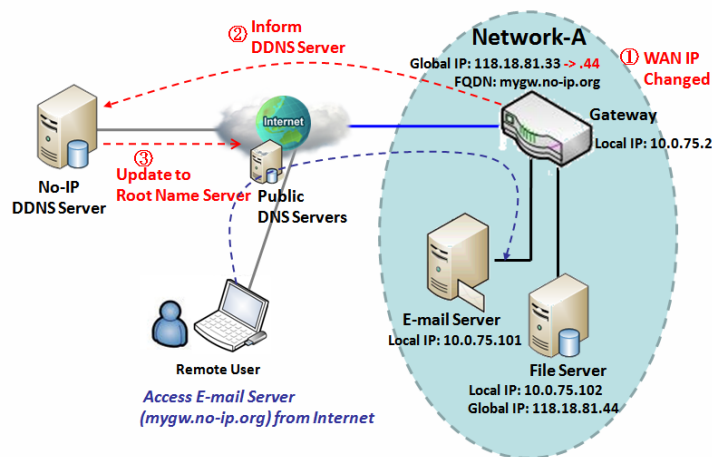

To host your server on a changing IP address, you have to use dynamic domain name service (DDNS). Therefore, anyone wishing to reach your host only needs to know the domain name. Dynamic DNS will map the name of your host to your current IP address, which changes each time you connect your Internet service provider.

The Dynamic DNS service allows the gateway to alias a public dynamic IP address to a static domain name, allowing the gateway to be more easily accessed from various locations on the Internet. As shown in the diagram, user registered a domain name to a

third-party DDNS service provider (NO-IP) to use DDNS function. Once the IP address of designated WAN interface has changed, the dynamic DNS agent in the gateway will inform the DDNS server with the new IP address. The server automatically re-maps your domain name with the changed IP address. So, other hosts or remote users in the Internet world are able to link to your gateway by using your domain name regardless of the changing global IP address.

4 [http://en.wikipedia.org/wiki/Domain\\_Name\\_System](http://en.wikipedia.org/wiki/Domain_Name_System)

5 [http://en.wikipedia.org/wiki/Dynamic\\_DNS](http://en.wikipedia.org/wiki/Dynamic_DNS)

# 4G LTE M2M Router

## DNS & DDNS Setting

Go to **Basic Network > DNS & DDNS > Configuration** Tab.

The DNS & DDNS setting allows user to setup Dynamic DNS feature and DNS redirect rules.

### Setup Dynamic DNS

The gateway allows you to custom your Dynamic DNS settings.

Dynamic DNS	
Item	Setting
▶ DDNS	<input type="checkbox"/> Enable
▶ WAN Interface	WAN-1
▶ Provider	DynDNS.org(Dynamic)
▶ Host Name	
▶ User Name / E-Mail	
▶ Password / Key	

DDNS (Dynamic DNS) Configuration		
Item	Value setting	Description
<b>DDNS</b>	The box is unchecked by default	Check the <b>Enable</b> box to activate this function.
<b>WAN Interface</b>	WAN 1 is set by default	Select the WAN Interface IP Address of the gateway.
<b>Provider</b>	<b>DynDNS.org (Dynamic)</b> is set by default	Select your DDNS provider of Dynamic DNS. It can be <b>DynDNS.org(Dynamic)</b> , <b>DynDNS.org(Custom)</b> , <b>NO-IP.com</b> , etc...
<b>Host Name</b>	1. String format can be any text 2. A Must filled setting	Your registered host name of Dynamic DNS. <b>Value Range: 0 ~ 63 characters.</b>
<b>User Name / E-Mail</b>	1. String format can be any text 2. A Must filled setting	Enter your User name or E-mail addresss of Dynamic DNS.
<b>Password / Key</b>	1. String format can be any text 2. A Must filled setting	Enter your Password or Key of Dynamic DNS.
<b>Save</b>	N/A	Click <b>Save</b> to save the settings
<b>Undo</b>	N/A	Click <b>Undo</b> to cancel the settings

# 4G LTE M2M Router

## Setup DNS Redirect

DNS redirect is a special function to redirect certain traffics to a specified host. Administrator can manage the internet / intranet traffics that are going to access some restricted DNS and force those traffics to be redirected to a specified host.

DNS Redirect	
Item	Setting
▶ DNS Redirect	<input type="checkbox"/> Enable

DNS Redirect Configuration		
Item	Value setting	Description
<b>DNS Redirect</b>	The box is unchecked by default	Check the <b>Enable</b> box to activate this function.
<b>Save</b>	N/A	Click <b>Save</b> to save the settings
<b>Undo</b>	N/A	Click <b>Undo</b> to cancel the settings

If you enabled the DNS Redirect function, you have to further specify the redirect rules. According to the rules, the gateway can redirect the traffic that matched the DNS to corresponding pre-defined IP address.

Redirect Rule					
ID	Mapping Rule	Condition	Description	Enable	Action

When **Add** button is applied, **Redirect Rule** screen will appear.

Redirect Rule					
Item	Setting				
Mapping Rule	<table border="1"><thead><tr><th>Domain Name</th><th>IP</th></tr></thead><tbody><tr><td><input type="text"/> (* for Any)</td><td><input type="text"/></td></tr></tbody></table>	Domain Name	IP	<input type="text"/> (* for Any)	<input type="text"/>
Domain Name	IP				
<input type="text"/> (* for Any)	<input type="text"/>				
Condition	<input type="text" value="Always"/>				
Description	<input type="text"/>				
Enable	<input type="checkbox"/> Enable				

Redirect Rule Configuration		
Item	Value setting	Description
<b>Domain Name</b>	1. String format can be any text	Enter a domain name to be redirect. The traffic to specified domain name will be redirect to the following IP address.

# 4G LTE M2M Router

	2. A Must filled setting	<b><i>Value Range:</i></b> at least 1 character is required; '*' for any.
<b>IP</b>	1. IPv4 format 2. A Must filled setting	Enter an IP Address as the target for the DNS redirect.
<b>Condition</b>	1. A Must filled setting 2. <b>Always is selected by default.</b>	Specify when will the DNS redirect action can be applied. It can be <b>Always</b> , or <b>WAN Block</b> . <b>Always:</b> The DNS redirect function can be applied to matched DNS all the time. <b>WAN Block:</b> The DNS redirect function can be applied to matched DNS only when the WAN connection is disconnected, or un-reachable.
<b>Description</b>	1. String format can be any text 2. A Must filled setting	Enter a brief description for this rule. <b><i>Value Range:</i></b> 0 ~ 63 characters.
<b>Enable</b>	The box is unchecked by default	Click the <b>Enable</b> button to activate this rule.
<b>Save</b>	N/A	Click <b>Save</b> to save the settings
<b>Undo</b>	N/A	Click <b>Undo</b> to cancel the settings

# 4G LTE M2M Router

## Chapter 3 Object Definition

### 3.1 Scheduling

Scheduling provides ability of adding/deleting time schedule rules, which can be applied to other functionality.

#### 3.1.1 Scheduling Configuration

Go to **Object Definition > Scheduling > Configuration** tab.

Time Schedule List		
<input type="button" value="Add"/>	<input type="button" value="Delete"/>	
ID	Rule Name	Actions

Button description		
Item	Value setting	Description
<b>Add</b>	N/A	Click the <b>Add</b> button to configure time schedule rule
<b>Delete</b>	N/A	Click the <b>Delete</b> button to delete selected rule(s)

When **Add** button is applied, Time Schedule Configuration and Time Period Definition screens will appear.

Time Schedule Configuration	
Item	Setting
▶ Rule Name	<input type="text"/>
▶ Rule Policy	<input type="button" value="Inactivate"/> the Selected Days and Hours Below.

Time Schedule Configuration		
Item	Value Setting	Description
<b>Rule Name</b>	String: any text	<b>Set rule name</b>
<b>Rule Policy</b>	Default Inactivate	<b>Inactivate/activate the function been applied to in the time period below</b>

# 4G LTE M2M Router

Time Period Definition			
ID	Week Day	Start Time (hh:mm)	End Time (hh:mm)
1	-- choose one -- ▾	<input type="text"/>	<input type="text"/>
2	-- choose one -- ▾	<input type="text"/>	<input type="text"/>
3	-- choose one -- ▾	<input type="text"/>	<input type="text"/>
4	-- choose one -- ▾	<input type="text"/>	<input type="text"/>
5	-- choose one -- ▾	<input type="text"/>	<input type="text"/>
6	-- choose one -- ▾	<input type="text"/>	<input type="text"/>
7	-- choose one -- ▾	<input type="text"/>	<input type="text"/>
8	-- choose one -- ▾	<input type="text"/>	<input type="text"/>

Time Period Definition		
Item	Value Setting	Description
<b>Week Day</b>	Select from menu	Select everyday or one of weekday
<b>Start Time</b>	Time format (hh :mm)	Start time in selected weekday
<b>End Time</b>	Time format (hh :mm)	End time in selected weekday
<b>Save</b>	N/A	Click Save to save the settings
<b>Undo</b>	N/A	Click Undo to cancel the settings
<b>Refresh</b>	N/A	Click the Refresh button to refresh the time schedule list.

# 4G LTE M2M Router

## 3.2 User (not supported)

Not supported feature for the purchased product, leave it as blank.

# 4G LTE M2M Router

## 3.3 Grouping (not supported)

Not supported feature for the purchased product, leave it as blank.

# 4G LTE M2M Router

## 3.4 External Server

Go to **Object Definition > External Server > External Server** tab.

The External Server setting allows user to add external server.

### Create External Server

External Server List <span>Add</span> <span>Delete</span>						
ID	Server Name	Server Type	Server IP/FQDN	Server Port	Server Enable	Actions

When **Add** button is applied, **External Server Configuration** screen will appear.

External Server Configuration	
Item	Setting
▶ Server Name	<input type="text"/>
▶ Server Type	Email Server <input type="text"/> User Name: <input type="text"/> Password: <input type="text"/>
▶ Server IP/FQDN	<input type="text"/>
▶ Server Port	<input type="text" value="25"/>
▶ Server	<input checked="" type="checkbox"/> Enable
<span>Save</span> <span>Undo</span>	

# 4G LTE M2M Router

External Server Configuration		
Item	Value setting	Description
<b>Sever Name</b>	1. String format can be any text 2. A Must filled setting	Enter a server name. Enter a name that is easy for you to understand.
<b>Server Type</b>	A Must filled setting	<p>Specify the Server Type of the external server, and enter the required settings for the accessing the server.</p> <hr/> <p><b>Email Server</b> (A Must filled setting) : When <b>Email Server</b> is selected, <b>User Name</b>, and <b>Password</b> are also required. <b>User Name</b> (String format: any text) <b>Password</b> (String format: any text)</p> <hr/> <p><b>RADIUS Server</b> (A Must filled setting) : When <b>RADIUS Server</b> is selected, the following settings are also required. Primary : <b>Shared Key</b> (String format: any text) Authentication Protocol (By default CHAP is selected) Session Timeout (By default 1) The values must be between 1 and 60. Idle Timeout: (By default 1) The values must be between 1 and 15. Secondary : <b>Shared Key</b> (String format: any text) Authentication Protocol (By default CHAP is selected) Session Timeout (By default 1) The values must be between 1 and 60. Idle Timeout: (By default 1) The values must be between 1 and 15.</p> <hr/> <p><b>FTP(SFTP) Server</b> (A Must filled setting) : When <b>FTP(SFTP) Server</b> is selected, the following settings are also required. <b>User Name</b> (String format: any text) <b>Password</b> (String format: any text) <b>Protocol</b> (Select <b>FTP</b> or <b>SFTP</b>) <b>Encryprion</b> (Select <b>Plain</b>, <b>Explicit FTPS</b> or <b>Implicit FTPS</b>) <b>Transfer mode</b> (Select <b>Passive</b> or <b>Active</b>)</p>
<b>Server IP/FQDN</b>	A Must filled setting	Specify the IP address or FQDN used for the external server.
<b>Server Port</b>	A Must filled setting	<p>Specify the Port used for the external server. If you selected a certain server type, the default server port number will be set. For <b>Email Server</b> 25 will be set by default; For <b>Syslog Server</b>, port 514 will be set by default; For <b>RADIUS Server</b>, port 1812 will be set by default; For <b>FTP(SFTP) Server</b>, port 21 will be set by default; <b>Value Range: 1 ~ 65535.</b></p>
<b>Account Port</b>	1. A Must filled setting 2. <b>1813 is set by default</b>	Specify the accounting port used if you selected external RADIUS server. <b>Value Range: 1 ~ 65535.</b>

# 4G LTE M2M Router

<b>Server</b>	The box is checked by default	Click <b>Enable to</b> activate this External Server.
<b>Save</b>	N/A	Click <b>Save</b> to save the settings
<b>Undo</b>	N/A	Click <b>Undo</b> to cancel the settings
<b>Refresh</b>	N/A	Click the <b>Refresh</b> button to refresh the external server list.

# 4G LTE M2M Router

## 3.5 Certificate

In cryptography, a public key certificate (also known as a digital certificate or identity certificate) is an electronic document used to prove ownership of a public key. The certificate includes information about the key, information about its owner's identity, and the digital signature of an entity that has verified the certificate's contents are genuine. If the signature is valid, and the person examining the certificate trusts the signer, then they know they can use that key to communicate with its owner<sup>6</sup>.

In a typical public-key infrastructure (PKI) scheme, the signer is a certificate authority (CA), usually a company such as VeriSign which charges customers to issue certificates for them. In a web of trust scheme, the signer is either the key's owner (a self-signed certificate) or other users ("endorsements") whom the person examining the certificate might know and trust. The device also plays as a CA role.

Certificates are an important component of Transport Layer Security (TLS, sometimes called by its older name SSL), where they prevent an attacker from impersonating a secure website or other server. They are also used in other important applications, such as email encryption and code signing. Here, it can be used in IPSec tunneling for user authentication.

### 3.5.1 Configuration (not supported)

Not supported feature for the purchased product, leave it as blank.

---

<sup>6</sup> [http://en.wikipedia.org/wiki/Public\\_key\\_certificate](http://en.wikipedia.org/wiki/Public_key_certificate).

# 4G LTE M2M Router

## 3.5.2 My Certificate

My Certificate includes a Local Certificate List. Local Certificate List shows all generated certificates by the root CA for the gateway. And it also stores the generated Certificate Signing Requests (CSR) which will be signed by other external CAs. The signed certificates can be imported as the local ones of the gateway.

### Self-signed Certificate Usage Scenario

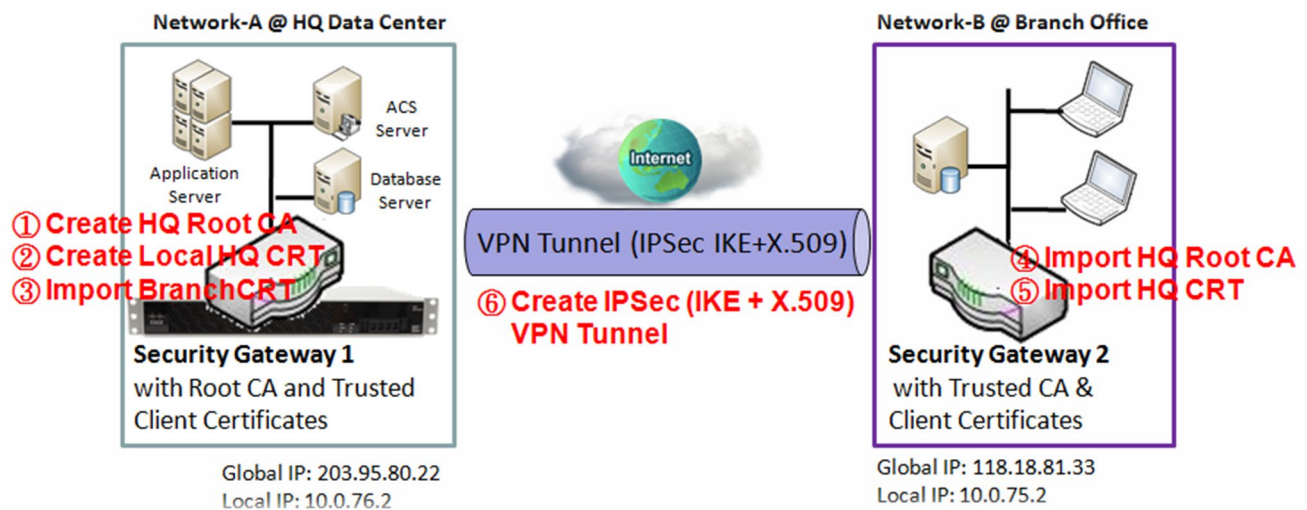

#### Scenario Application Timing

When the enterprise gateway owns the root CA and VPN tunneling function, it can generate its own local certificates by being signed by itself or import any local certificates that are signed by other external CAs. Also import the trusted certificates for other CAs and Clients. In addition, since it has the root CA, it also can sign Certificate Signing Requests (CSR) to form corresponding certificates for others. These certificates can be used for two remote peers to make sure their identity during establishing a VPN tunnel.

#### Scenario Description

Gateway 1 generates the root CA and a local certificate (HQCRT) signed by itself. Import a trusted certificate (BranchCRT) –a BranchCSR certificate of Gateway 2 signed by root CA of Gateway 1.

Gateway 2 creates a CSR (BranchCSR) to let the root CA of the Gateway 1 sign it to be the BranchCRT certificate. Import the certificate into the Gateway 2 as a local certificate. In addition, also import the certificates of the root CA of the Gateway 1 into the Gateway 2 as the trusted ones. (Please also refer to following two sub-sections)

Establish an IPSec VPN tunnel with IKE and X.509 protocols by starting from either peer, so that all

# 4G LTE M2M Router

client hosts in these both subnets can communicate with each other.

## Parameter Setup Example

For Network-A at HQ

Following tables list the parameter configuration as an example for the "My Certificate" function used in the user authentication of IPsec VPN tunnel establishing, as shown in above diagram. The configuration example must be combined with the ones in following two sections to complete the whole user scenario.

Use default value for those parameters that are not mentioned in the tables.

<b>Configuration Path</b>	[My Certificate]-[Root CA Certificate Configuration]
<b>Name</b>	<b>HQRootCA</b>
<b>Key</b>	Key Type: <b>RSA</b> Key Length: <b>1024-bits</b>
<b>Subject Name</b>	Country(C): <b>TW</b> State(ST): <b>Taiwan</b> Location(L): <b>Tainan</b> Organization(O): <b>D-LinkHQ</b> Organization Unit(OU): <b>HQRD</b> Common Name(CN): <b>HQRootCA</b> E-mail: <b>hqrootca@D-Link.com.tw</b>

<b>Configuration Path</b>	[My Certificate]-[Local Certificate Configuration]
<b>Name</b>	<b>HQCRT</b> Self-signed: <input checked="" type="checkbox"/>
<b>Key</b>	Key Type: <b>RSA</b> Key Length: <b>1024-bits</b>
<b>Subject Name</b>	Country(C): <b>TW</b> State(ST): <b>Taiwan</b> Location(L): <b>Tainan</b> Organization(O): <b>D-LinkHQ</b> Organization Unit(OU): <b>HQRD</b> Common Name(CN): <b>HQCRT</b> E-mail: <b>hqcert@D-Link.com.tw</b>

<b>Configuration Path</b>	[IPSec]-[Configuration]
<b>IPSec</b>	<input checked="" type="checkbox"/> <b>Enable</b>

<b>Configuration Path</b>	[IPSec]-[Tunnel Configuration]
<b>Tunnel</b>	<input checked="" type="checkbox"/> <b>Enable</b>
<b>Tunnel Name</b>	<b>s2s-101</b>
<b>Interface</b>	<b>WAN 1</b>
<b>Tunnel Scenario</b>	<b>Site to Site</b>
<b>Operation Mode</b>	<b>Always on</b>

<b>Configuration Path</b>	[IPSec]-[Local & Remote Configuration]
<b>Local Subnet</b>	<b>10.0.76.0</b>
<b>Local Netmask</b>	<b>255.255.255.0</b>
<b>Full Tunnel</b>	<b>Disable</b>
<b>Remote Subnet</b>	<b>10.0.75.0</b>
<b>Remote Netmask</b>	<b>255.255.255.0</b>
<b>Remote Gateway</b>	<b>118.18.81.33</b>

# 4G LTE M2M Router

<b>Configuration Path</b>	[IPSec]-[Authentication]
<b>Key Management</b>	<i>IKE+X.509</i> Local Certificate: <i>HQCRT</i> Remote Certificate: <i>BranchCRT</i>
<b>Local ID</b>	<i>User Name Network-A</i>
<b>Remote ID</b>	<i>User Name Network-B</i>

<b>Configuration Path</b>	[IPSec]-[IKE Phase]
<b>Negotiation Mode</b>	<i>Main Mode</i>
<b>X-Auth</b>	<i>None</i>

For Network-B at Branch Office

Following tables list the parameter configuration as an example for the "My Certificate" function used in the user authentication of IPSec VPN tunnel establishing, as shown in above diagram. The configuration example must be combined with the ones in following two sections to complete the whole user scenario.

Use default value for those parameters that are not mentioned in the tables.

<b>Configuration Path</b>	[My Certificate]-[Local Certificate Configuration]
<b>Name</b>	<i>BranchCRT</i> Self-signed: <input type="checkbox"/>
<b>Key</b>	Key Type: <i>RSA</i> Key Length: <i>1024-bits</i>
<b>Subject Name</b>	Country(C): <i>TW</i> State(ST): <i>Taiwan</i> Location(L): <i>Tainan</i> Organization(O): <i>D-LinkBranch</i> Organization Unit(OU): <i>BranchRD</i> Common Name(CN): <i>BranchCRT</i> E-mail: <i>branchcrt@D-Link.com.tw</i>

<b>Configuration Path</b>	[IPSec]-[Configuration]
<b>IPSec</b>	■ <i>Enable</i>

<b>Configuration Path</b>	[IPSec]-[Tunnel Configuration]
<b>Tunnel</b>	■ <i>Enable</i>
<b>Tunnel Name</b>	<i>s2s-102</i>
<b>Interface</b>	<i>WAN 1</i>
<b>Tunnel Scenario</b>	<i>Site to Site</i>
<b>Operation Mode</b>	<i>Always on</i>

<b>Configuration Path</b>	[IPSec]-[Local & Remote Configuration]
<b>Local Subnet</b>	<i>10.0.75.0</i>
<b>Local Netmask</b>	<i>255.255.255.0</i>
<b>Full Tunnel</b>	<i>Disable</i>
<b>Remote Subnet</b>	<i>10.0.76.0</i>

# 4G LTE M2M Router

Remote Netmask	255.255.255.0
Remote Gateway	203.95.80.22

Configuration Path	[IPSec]-[Authentication]
Key Management	IKE+X.509 Local Certificate: <b>BranchCRT</b> Remote Certificate: <b>HQCRT</b>
Local ID	User Name Network-B
Remote ID	User Name Network-A

Configuration Path	[IPSec]-[IKE Phase]
Negotiation Mode	Main Mode
X-Auth	None

## Scenario Operation Procedure

In above diagram, "Gateway 1" is the gateway of Network-A in headquarters and the subnet of its Intranet is 10.0.76.0/24. It has the IP address of 10.0.76.2 for LAN interface and 203.95.80.22 for WAN-1 interface. "Gateway 2" is the gateway of Network-B in branch office and the subnet of its Intranet is 10.0.75.0/24. It has the IP address of 10.0.75.2 for LAN interface and 118.18.81.33 for WAN-1 interface. They both serve as the NAT security gateways.

Gateway 1 generates the root CA and a local certificate (HQCRT) that is signed by itself. Import the certificates of the root CA and HQCRT into the "Trusted CA Certificate List" and "Trusted Client Certificate List" of Gateway 2.

Gateway 2 generates a Certificate Signing Request (BranchCSR) for its own certificate (BranchCRT) (Please generate one not self-signed certificate in the Gateway 2, and click on the "View" button for that CSR. Just downloads it). Take the CSR to be signed by the root CA of Gateway 1 and obtain the BranchCRT certificate (you need rename it). Import the certificate into the "Trusted Client Certificate List" of the Gateway 1 and the "Local Certificate List" of Gateway 2.

Gateway 2 can establish an IPSec VPN tunnel with "Site to Site" scenario and IKE and X.509 protocols to Gateway 1.

Finally, the client hosts in two subnets of 10.0.75.0/24 and 10.0.76.0/24 can communicate with each other.

# 4G LTE M2M Router

## My Certificate Setting

Go to **Object Definition > Certificate > My Certificate** tab.

The My Certificate setting allows user to create local certificates. In "My Certificate" page, there are two configuration windows for the "My Certificate" function. The "Local Certificate List" window shows the stored certificates or CSRs for representing the gateway. The "Local Certificate Configuration" window can let you fill required information necessary for corresponding certificate to be generated by itself, or corresponding CSR to be signed by other CAs.

### Create Local Certificate

Local Certificate List					
	<input type="button" value="Add"/>	<input type="button" value="Import"/>	<input type="button" value="Delete"/>		
ID	Name	Subject	Issuer	Valid To	Actions

When **Add** button is applied, **Local Certificate Configuration** screen will appear. The required information to be filled for the certificate or CSR includes the name, key and subject name. It is a certificate if the "Self-signed" box is checked; otherwise, it is a CSR.

Local Certificate Configuration	
Item	Setting
▶ Name	<input type="text"/> Self-signed : <input type="checkbox"/>
▶ Key	Key Type : <input type="text" value="RSA"/> Key Length : <input type="text" value="1024-bits"/> Digest Algorithm : <input type="text" value="SHA-1"/>
▶ Subject Name	Country(C) : <input type="text"/> State(ST) : <input type="text"/> Location(L) : <input type="text"/> Organization(O) : <input type="text"/> Organization Unit(OU) : <input type="text"/> Common Name(CN) : <input type="text"/> E-mail : <input type="text"/>
▶ Extra Attributes	Challenge Password: <input type="text"/> Unstructured Name: <input type="text"/>
▶ SCEP Enrollment	Enable: <input type="checkbox"/> SCEP Server: <input type="text" value="--- Option ---"/> <input type="button" value="Add Object"/> CA Certificate: <input type="text" value="JH.crt"/> CA Encryption Certificate: <input type="text" value="--- Option ---"/> (Optional) CA Identifier: <input type="text"/> (Optional)

# 4G LTE M2M Router

Local Certificate Configuration		
Item	Value setting	Description
<b>Name</b>	1. String format can be any text 2. A Must filled setting	Enter a certificate name. It will be a certificate file name If <b>Self-signed</b> is checked, it will be signed by root CA. If <b>Self-signed</b> is not checked, it will generate a certificate signing request (CSR).
<b>Key</b>	A Must filled setting	This field is to specify the key attributes of certificate. <b>Key Type</b> to set public-key cryptosystems. Currently, only RSA is supported. <b>Key Length</b> to set the length in bits of the key used in a cryptographic algorithm. It can be 512/768/1024/1536/2048. <b>Digest Algorithm</b> to set identifier in the signature algorithm identifier of certificates. It can be MD5/SHA-1.
<b>Subject Name</b>	A Must filled setting	This field is to specify the information of certificate. <b>Country(C)</b> is the two-letter ISO code for the country where your organization is located. <b>State(ST)</b> is the state where your organization is located. <b>Location(L)</b> is the location where your organization is located. <b>Organization(O)</b> is the name of your organization. <b>Organization Unit(OU)</b> is the name of your organization unit. <b>Common Name(CN)</b> is the name of your organization. <b>Email</b> is the email of your organization. It has to be email address setting only.
<b>Extra Attributes</b>	A Must filled setting	This field is to specify the extra information for generating a certificate. <b>Challenge Password</b> for the password you can use to request certificate revocation in the future. <b>Unstructured Name</b> for additional information.
<b>SCEP Enrollment</b>	A Must filled setting	This field is to specify the information of SCEP. If user wants to generate a certificate signing request (CSR) and then signed by SCEP server online, user can check the <b>Enable</b> box.  Select a <b>SCEP Server</b> to identify the SCEP server for use. The server detailed information could be specified in External Servers. Refer to <b>Object Definition &gt; External Server &gt; External Server</b> . You may click <b>Add Object</b> button to generate, and the settings are the same as those defined in <b>Section 3.4 External Server</b> .  Select a <b>CA Certificate</b> to identify which certificate could be accepted by SCEP server for authentication. It could be generated in Trusted Certificates.  Select an optional <b>CA Encryption Certificate</b> , if it is required, to identify which certificate could be accepted by SCEP server for encryption data information. It could be generated in Trusted Certificates.  Fill in optional <b>CA Identifier</b> to identify which CA could be used for signing certificates.
<b>Save</b>	N/A	Click the <b>Save</b> button to save the configuration.
<b>Back</b>	N/A	When the <b>Back</b> button is clicked, the screen will return to previous page.

# 4G LTE M2M Router

When **Import** button is applied, an Import screen will appear. You can import a certificate from an existed certificate file, or directly paste a PEM encoded string as the certificate.

The screenshot shows a web interface for importing certificates. It has two main sections. The top section, titled "Import", has a "Browse..." button and the text "未選擇檔案。" (No file selected). The bottom section, titled "PEM Encoded", has a large empty text area for pasting the certificate string. Both sections have "Apply" and "Cancel" buttons.

Import Item	Value setting	Description
<b>Import</b>	A Must filled setting	Select a certificate file from user's computer, and click the <b>Apply</b> button to import the specified certificate file to the gateway.
<b>PEM Encoded</b>	1. String format can be any text 2. A Must filled setting	This is an alternative approach to import a certificate. You can directly fill in (Copy and Paste) the PEM encoded certificate string, and click the <b>Apply</b> button to import the specified certificate to the gateway.
<b>Apply</b>	N/A	Click the <b>Apply</b> button to import the certificate.
<b>Cancel</b>	N/A	Click the <b>Cancel</b> button to discard the import operation and the screen will return to the My Certificates page.

# 4G LTE M2M Router

## 3.5.3 Trusted Certificate

Trusted Certificate includes Trusted CA Certificate List, Trusted Client Certificate List, and Trusted Client Key List. The Trusted CA Certificate List places the certificates of external trusted CAs. The Trusted Client Certificate List places the others' certificates what you trust. And the Trusted Client Key List places the others' keys what you trusted.

### Self-signed Certificate Usage Scenario

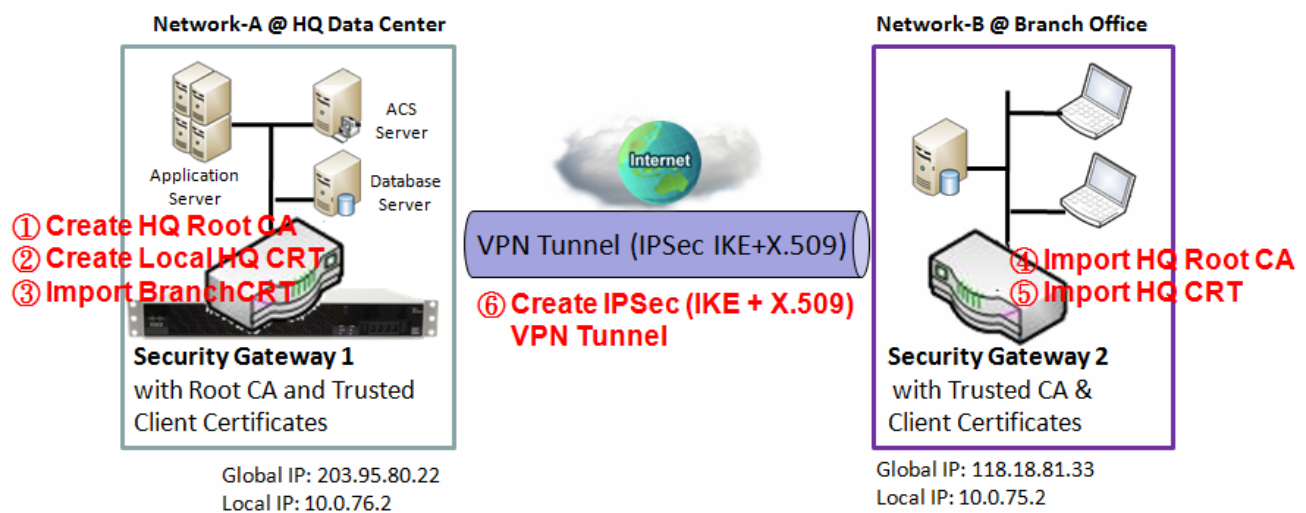

Scenario Application Timing (same as the one described in "My Certificate" section)

When the enterprise gateway owns the root CA and VPN tunneling function, it can generate its own local certificates by being signed by itself. Also imports the trusted certificates for other CAs and Clients. These certificates can be used for two remote peers to make sure their identity during establishing a VPN tunnel.

Scenario Description (same as the one described in "My Certificate" section)

Gateway 1 generates the root CA and a local certificate (HQCRT) signed by itself. Import a trusted certificate (BranchCRT) –a BranchCSR certificate of Gateway 2 signed by root CA of Gateway 1.

Gateway 2 creates a CSR (BranchCSR) to let the root CA of the Gateway 1 sign it to be the BranchCRT certificate. Import the certificate into the Gateway 2 as a local certificate. In addition, also imports the certificates of the root CA of Gateway 1 into the Gateway 2 as the trusted ones. (Please also refer to "My Certificate" and "Issue Certificate" sections).

Establish an IPSec VPN tunnel with IKE and X.509 protocols by starting from either peer, so that all client hosts in these both subnets can communicate with each other.

Parameter Setup Example (same as the one described in "My Certificate" section)

# 4G LTE M2M Router

For Network-A at HQ

Following tables list the parameter configuration as an example for the "Trusted Certificate" function used in the user authentication of IPsec VPN tunnel establishing, as shown in above diagram. The configuration example must be combined with the ones in "My Certificate" and "Issue Certificate" sections to complete the setup for the whole user scenario.

<b>Configuration Path</b>	[Trusted Certificate]-[Trusted Client Certificate List]
<b>Command Button</b>	<i>Import</i>

<b>Configuration Path</b>	[Trusted Certificate]-[Trusted Client Certificate Import from a File]
<b>File</b>	<i>BranchCRT.crt</i>

For Network-B at Branch Office

Following tables list the parameter configuration as an example for the "Trusted Certificate" function used in the user authentication of IPsec VPN tunnel establishing, as shown in above diagram. The configuration example must be combined with the ones in "My Certificate" and "Issued Certificate" sections to complete the setup for the whole user scenario.

<b>Configuration Path</b>	[Trusted Certificate]-[Trusted CA Certificate List]
<b>Command Button</b>	<i>Import</i>

<b>Configuration Path</b>	[Trusted Certificate]-[Trusted CA Certificate Import from a File]
<b>File</b>	<i>HQRootCA.crt</i>

<b>Configuration Path</b>	[Trusted Certificate]-[Trusted Client Certificate List]
<b>Command Button</b>	<i>Import</i>

<b>Configuration Path</b>	[Trusted Certificate]-[Trusted Client Certificate Import from a File]
<b>File</b>	<i>HQCRT.crt</i>

Scenario Operation Procedure (same as the one described in "My Certificate" section)

In above diagram, the "Gateway 1" is the gateway of Network-A in headquarters and the subnet of its Intranet is 10.0.76.0/24. It has the IP address of 10.0.76.2 for LAN interface and 203.95.80.22 for WAN-1 interface. The "Gateway 2" is the gateway of Network-B in branch office and the subnet of its Intranet is 10.0.75.0/24. It has the IP address of 10.0.75.2 for LAN interface and 118.18.81.33 for WAN-1 interface. They both serve as the NAT security gateways.

In Gateway 2 import the certificates of the root CA and HQCRT that were generated and signed by Gateway 1 into the "Trusted CA Certificate List" and "Trusted Client Certificate List" of Gateway 2.

# 4G LTE M2M Router

Import the obtained BranchCRT certificate (the derived BranchCSR certificate after Gateway 1's root CA signature) into the "Trusted Client Certificate List" of the Gateway 1 and the "Local Certificate List" of the Gateway 2. For more details, refer to the Network-B operation procedure in "My Certificate" section of this manual.

Gateway 2 can establish an IPSec VPN tunnel with "Site to Site" scenario and IKE and X.509 protocols to Gateway 1.

Finally, the client hosts in two subnets of 10.0.75.0/24 and 10.0.76.0/24 can communicate with each other.

# 4G LTE M2M Router

## Trusted Certificate Setting

Go to **Object Definition > Certificate > Trusted Certificate** tab.

The Trusted Certificate setting allows user to import trusted certificates and keys.

### Import Trusted CA Certificate

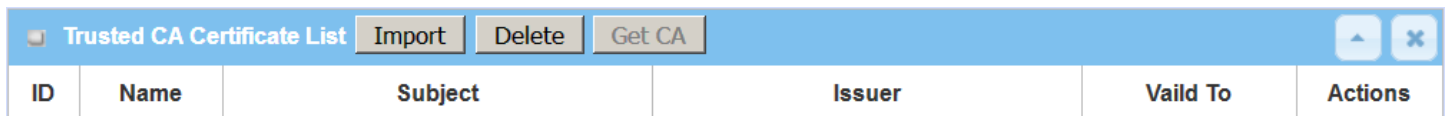

ID	Name	Subject	Issuer	Valid To	Actions
----	------	---------	--------	----------	---------

When **Import** button is applied, a **Trusted CA import** screen will appear. You can import a Trusted CA certificate from an existed certificate file, or directly paste a PEM encoded string as the certificate.

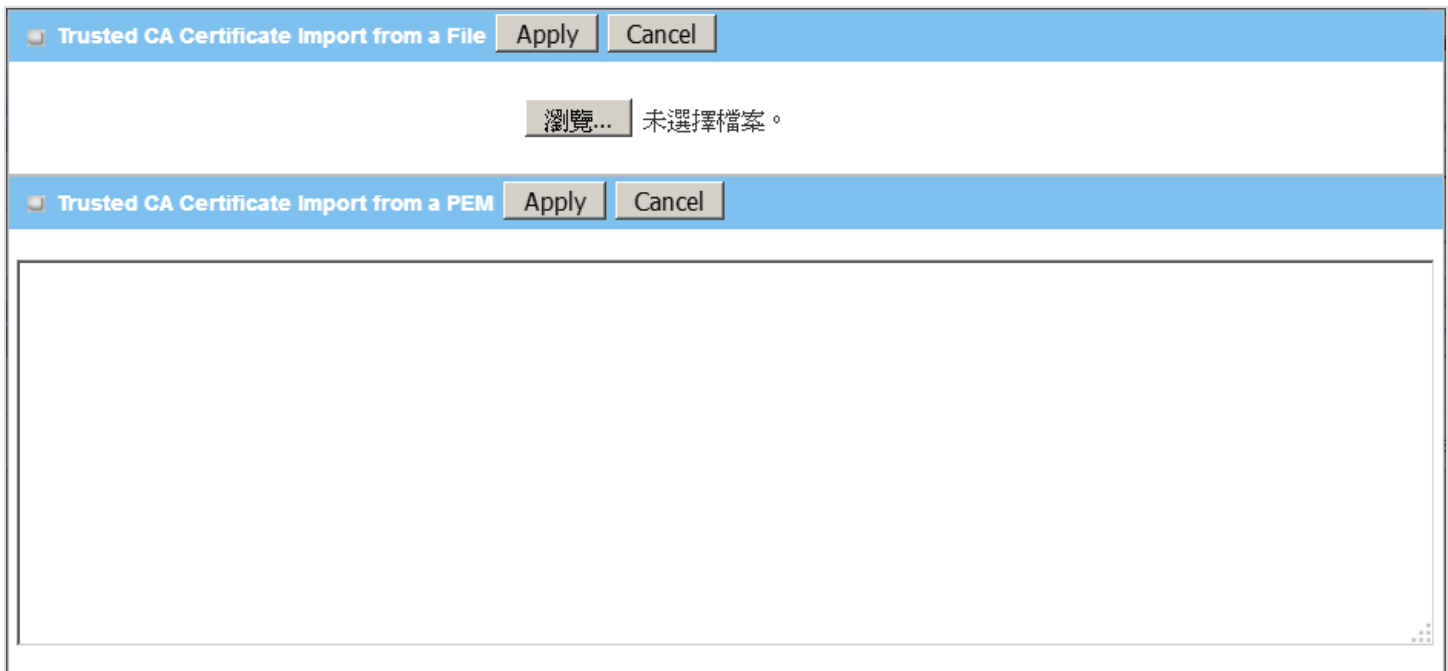

Trusted CA Certificate List		
Item	Value setting	Description
<b>Import from a File</b>	A Must filled setting	Select a CA certificate file from user's computer, and click the <b>Apply</b> button to import the specified CA certificate file to the gateway.
<b>Import from a PEM</b>	1. String format can be any text 2. A Must filled setting	This is an alternative approach to import a CA certificate. You can directly fill in (Copy and Paste) the PEM encoded CA certificate string, and click the <b>Apply</b> button to import the specified CA certificate to the gateway.
<b>Apply</b>	N/A	Click the <b>Apply</b> button to import the certificate.
<b>Cancel</b>	N/A	Click the <b>Cancel</b> button to discard the import operation and the screen will return to the Trusted Certificates page.

# 4G LTE M2M Router

Instead of importing a Trusted CA certificate with mentioned approaches, you can also get the CA certificate from the SECP server.

If **SCEP** is enabled (Refer to **Object Definition > Certificate > Configuration**), you can click **Get CA** button, a Get CA Configuration screen will appear.

Item	Setting
▶ SCEP Server	--- Option --- <input type="button" value="Add Object"/>
▶ CA Identifier	<input type="text"/> (Optional)

Get CA Configuration		
Item	Value setting	Description
<b>SCEP Server</b>	A Must filled setting	Select a <b>SCEP Server</b> to identify the SCEP server for use. The server detailed information could be specified in External Servers. Refer to <b>Object Definition &gt; External Server &gt; External Server</b> . You may click <b>Add Object</b> button to generate.
<b>CA Identifier</b>	1. String format can be any text	Fill in optional <b>CA Identifier</b> to identify which CA could be used for signing certificates.
<b>Save</b>	N/A	Click <b>Save</b> to save the settings.
<b>Close</b>	N/A	Click the <b>Close</b> button to return to the Trusted Certificates page.

## Import Trusted Client Certificate

ID	Name	Subject	Issuer	Valid To	Actions
----	------	---------	--------	----------	---------

When **Import** button is applied, a **Trusted Client Certificate Import** screen will appear. You can import a Trusted Client Certificate from an existed certificate file, or directly paste a PEM encoded string as the certificate.

# 4G LTE M2M Router

Trusted Client Certificate Import from a File

未選擇檔案。

Trusted Client Certificate Import from a PEM

Trusted Client Certificate List		
Item	Value setting	Description
<b>Import from a File</b>	A Must filled setting	Select a certificate file from user's computer, and click the <b>Apply</b> button to import the specified certificate file to the gateway.
<b>Import from a PEM</b>	1. String format can be any text 2. A Must filled setting	This is an alternative approach to import a certificate. You can directly fill in (Copy and Paste) the PEM encoded certificate string, and click the <b>Apply</b> button to import the specified certificate to the gateway.
<b>Apply</b>	N/A	Click the <b>Apply</b> button to import certificate.
<b>Cancel</b>	N/A	Click the <b>Cancel</b> button to discard the import operation and the screen will return to the Trusted Certificates page.

## Import Trusted Client Key

Trusted Client Key List

ID	Name	Actions
----	------	---------

When **Import** button is applied, a **Trusted Client Key Import** screen will appear. You can import a Trusted Client Key from an existed file, or directly paste a PEM encoded string as the key.

# 4G LTE M2M Router

Trusted Client Key Import from a File

未選擇檔案。

Trusted Client Key Import from a PEM

Trusted Client Key List		
Item	Value setting	Description
<b>Import from a File</b>	A Must filled setting	Select a certificate key file from user's computer, and click the <b>Apply</b> button to import the specified key file to the gateway.
<b>Import from a PEM</b>	1. String format can be any text 2. A Must filled setting	This is an alternative approach to import a certificate key. You can directly fill in (Copy and Paste) the PEM encoded certificate key string, and click the <b>Apply</b> button to import the specified certificate key to the gateway.
<b>Apply</b>	N/A	Click the <b>Apply</b> button to import the certificate key.
<b>Cancel</b>	N/A	Click the <b>Cancel</b> button to discard the import operation and the screen will return to the Trusted Certificates page.

# 4G LTE M2M Router

## Chapter 4 Field Communication

### 4.1 Bus & Protocol

The gateway may equip a serial port for various serial communication use through connecting the RS-232 or RS-485 serial device to an IP-based Ethernet LAN. These communication protocols make user access serial devices anywhere over a local LAN or the Internet easily.

#### 4.1.1 Port Configuration

Before using the supported field communication function, like Virtual COM, you need to configure the physical communication port first.

The port configuration screen allows user to configure the operation mode and physical layer settings for each serial interface, and also can quick switch from one communication protocol to another for the serial port. The number of ports and type of the supported protocols could be different for the purchased gateway model.

#### *Port Configuration Setting*

Go to **Field Communication > Bus & Protocol > Port Configuration** tab.

In "Port Configuration" page, there is only one configuration window for the serial port settings. The "Configuration" window can let you specify serial port parameters including the operation mode being "Virtual COM" or disabled, the interface, the baud rate, the data bit length, the stop bit length, the flow control being "RTS/CTS", "DTS/DSR" or "None", and the parity.

Click **Edit** button to specify the port configuration. It must be consistent to that of the peer serial device.

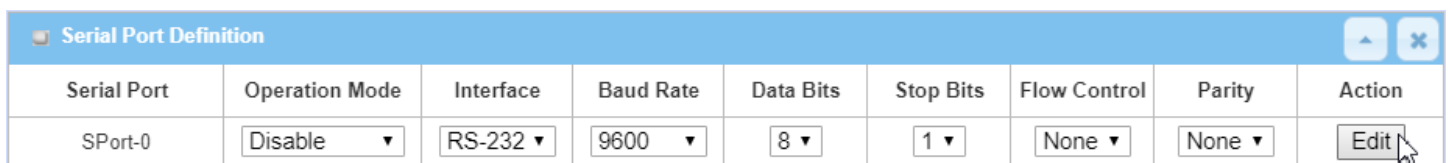

Serial Port	Operation Mode	Interface	Baud Rate	Data Bits	Stop Bits	Flow Control	Parity	Action
SPort-0	Disable ▼	RS-232 ▼	9600 ▼	8 ▼	1 ▼	None ▼	None ▼	Edit

Port Configuration Window		
Item	Value setting	Description
Serial Port	N/A	It displays the serial port ID of the serial port. The number of serial ports varies from the purchased model.

# 4G LTE M2M Router

<b>Operation Mode</b>	<b>Disable</b> is set by default	It displays the current selected operation mode for the serial interface. It can be <b>Disable</b> , <b>Virtual COM</b> , <b>AT Mode</b> , <b>Modem Mode</b> . <b>Disable:</b> The serial port is disabled. <b>Virtual COM:</b> The serial port is operated in Virtual COM mode, and you have to further configure the detailed settings in Virtual COM tab. <b>AT Mode:</b> The serial port is operated in AT command mode. You can connect to a serial terminal, and issue specific AT commands. For the supported AT commands, you can check with the manufacture. <b>Modem Mode:</b> The serial port is operated in 4G serial modem mode. The gateway just bridge the 4G cellular interface and the serial port.
<b>Interface</b>	<b>RS-232</b> is set by default	Select the physical interface type for connecting to the access device(s) with the same interface specification. Depending on the purchase model, the supported interface type could be RS-232 or RS-485.
<b>Baud Rate</b>	<b>19200</b> is set by default	Select the appropriate baud rate for serial device communication. RS-232: 1200 / 2400 / 4800 / 9600 / 19200 / 38400 / 57600 / 115200 RS-485 can use higher baud rate for 230400 and 460800. It depends on the cable length and the installed environment. The longer cable, the lower baud rate for it.
<b>Data Bits</b>	<b>8</b> is set by default	Select 8 or 7 for data bits.
<b>Stop Bits</b>	<b>1</b> is set by default	Select 1 or 2 for stop bits.
<b>Flow Control</b>	<b>None</b> is set by default	Select None / RTS, CTS / DTS, DSR for Flow Control in RS-232 mode. The supporting of Flow Control depends on the purchased model.
<b>Parity</b>	<b>None</b> is set by default	Select None / Even / Odd for Parity bit.
<b>Action</b>	N/A	Click <b>Edit</b> button to change the operation mode, or modify the parameters mentioned above for the serial interface communication.
<b>Save</b>	N/A	Click <b>Save</b> button to save the settings.
<b>Undo</b>	N/A	Click <b>Undo</b> button to cancel the settings.



# 4G LTE M2M Router

## TCP Server Mode

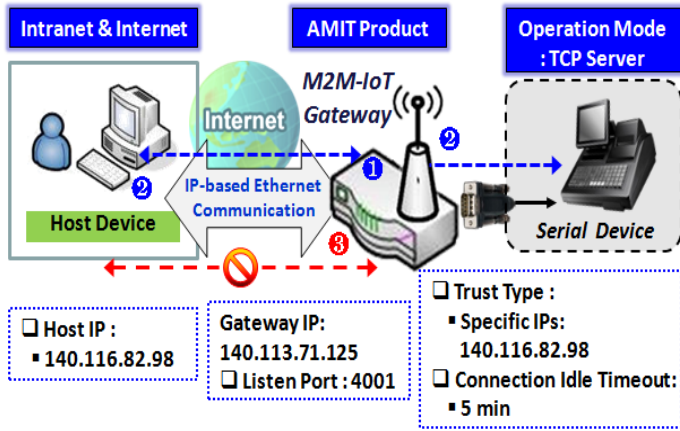

- ① Gateway remain Listening and Host will Establish a TCP Connection with it.
- ② Host Send Data then Gateway Transmit it to the Serial Device.
- ③ Terminate this TCP Connection once Idle Timeout reached 5 mins.

When the administrator expects the gateway to wait passively for the serial data requests from the Host Device (usually we use a computer to play as a Host), and the Host will establish a TCP connection to get data from the serial device, the operation mode for the "Virtual COM" function is required to be "TCP Server". In this mode, the gateway provides a unique "IP: Port" address on a TCP/IP network. It supports up to 4 simultaneous connections, so that multiple hosts can collect data from the same serial device at the same time. After the data has been transferred, the TCP connection will be automatically disconnected from the host computer by using the TCP alive check timeout or idle timeout settings.

## UDP Mode

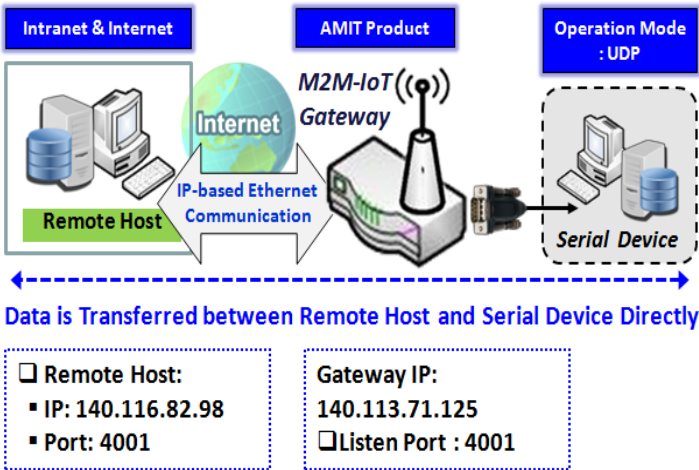

Data is Transferred between Remote Host and Serial Device Directly

If both the Remote Host Computer and the serial device are expected to initiate a data transfer when it requires doing that, the operation mode for the "Virtual COM" function in the gateway is required to be "UDP". In this mode, the UDP data can be transferred between the gateway and multiple host computers from either peer, making this mode ideal for message display applications.

The remote host computer can directly send UDP data to the serial device via the gateway, and also receive UDP data from the serial device via the gateway at the same time. The gateway supports up to 4 legal hosts to connect simultaneously to the serial device via the gateway.

# 4G LTE M2M Router

## RFC-2217 Mode

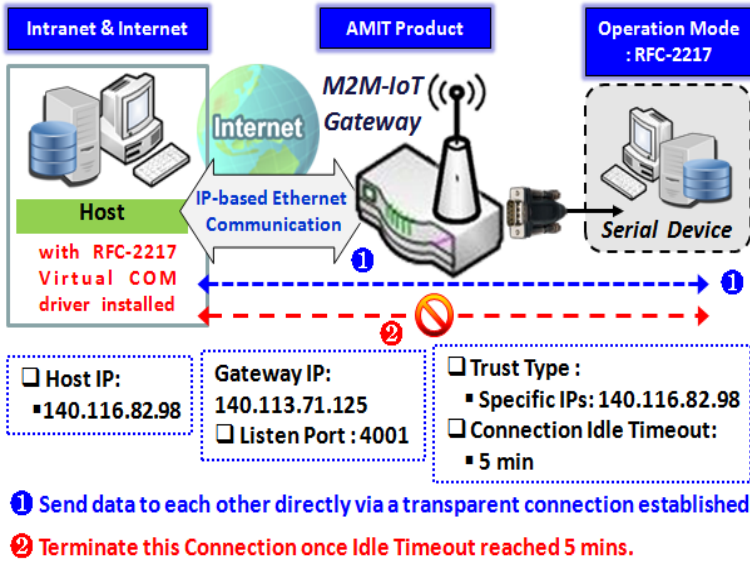

RFC-2217 defines general COM port control options based on telnet protocol. A host computer with RFC-2217 driver installed can monitor and manage the remote serial device attached to the gateway's serial port, as though they were connected to the local serial port. When a virtual serial port on the local serial device is being created, it is required to specify the IP-address of the host computers to establish connection with.

Any 3rd party driver supporting RFC2217 can be used to install in the host computer, the driver establishes a transparent connection between host and serial device by mapping the IP:Port of the gateway's serial port to a virtual local COM

port on the host computer.

The host computer can directly send data to the serial device via the gateway, and also receive data from the serial device via the gateway at the same time. The gateway supports up to 4 Internet host computers.

# 4G LTE M2M Router

## Virtual COM Setting

Virtual COM setting screen enables user to connect a Virtual COM port based device to the Internet. It allows user to access serial data remotely. There are Disable, TCP Client, TCP Server, UDP, and RFC2217 modes for remote accessing the connected serial device. By default, it is configured in Disable mode.

To use the Virtual COM function, you have to specify the operation mode for the multi-function serial port first. Go to **Field Communication > Bus & Protocol > Port Configuration** tab, select the Virtual COM as expected operation mode, and finish the related port configuration as well.

After that, go to **Field Communication > Bus & Protocol > Virtual COM** tab for detailed configuration of Virtual COM setting.

### Enable TCP Client Mode

Configure the gateway as the TCP (Transmission Control Protocol) Client. In TCP Client mode, device initiates a TCP connection with a TCP server when there is data to transmit. Device disconnects from the server when the connection is Idle for a specified period. You may also enable full time connection with the TCP server.

Operation Mode Definition for each Serial Port									
Serial Port	Operation Mode	Listen Port	Trust Type	Max Connection	Connection Control	Connection Idle Timeout	Alive Check Timeout	Enable	Action
SPort-0	TCP Client ▼	4001 (1~65535)	Allow All ▼	1	Always on ▼	0 (0-3600secs)	0 (0-3600secs)	<input type="checkbox"/>	Edit

Enable TCP Client Mode Window		
Item	Value setting	Description
<b>Operation Mode</b>	A Must filled setting	Select <b>TCP Client</b> .
<b>Connection Control</b>	<b>Always on</b> is set by default	Choose <b>Always on</b> for a TCP full time connection. Otherwise, choose <b>On-Demand</b> to initiate TCP connection only when required to transmit and disconnect at idle timeout.
<b>Connection Idle Timeout</b>	1. 0 is set by default 2. Range 0 to 3600 sec.	Enter the idle timeout in minutes. The idle timeout is used to disconnect the TCP connection when idle time elapsed . Idle timeout is only available when <b>On-Demand</b> is selected in the <b>Connection Control</b> field. <b>Value Range:</b> 0 ~ 3600 seconds.
<b>Alive Check Timeout</b>	1. 0 is set by default 2. Range 0 to 3600 sec.	Enter the time period of alive check timeout. The TCP connection will be terminated if it doesn't receive response of alive-check longer than this timeout setting Alive check timeout is only available when <b>On-Demand</b> is selected in the <b>Connection Control</b> field. <b>Value Range:</b> 0 ~ 3600 seconds.
<b>Enable</b>	The box is unchecked by default.	Check the <b>Enable</b> box to activate the corresponding serial port in specified operation mode.
<b>Save</b>	N/A	Click the <b>Save</b> button to save the configuration

# 4G LTE M2M Router

## Specify Data Packing Parameters

Data Packing (for TCP Client, TCP Server and UDP operation mode)				
Serial Port	Data Buffer Length	Delimiter Character 1	Delimiter Character 2	Data Timeout Transmit
SPort-0	<input type="text" value="0"/> (0~1024)	<input type="text" value="0"/> (Hex) <input type="checkbox"/> Enable	<input type="text" value="0"/> (Hex) <input type="checkbox"/> Enable	<input type="text" value="0"/> (0~1000ms)

Data Packing Configuration		
Item	Value setting	Description
<b>Data Buffer Length</b>	1.An optional filled setting 2.Default value is 0	Enter the data buffer length for the serial port. <b>Value Range:</b> 0 ~ 1024.
<b>Delimiter Character 1</b>	1.An optional filled setting 2.Default value is 0	Check the <b>Enable</b> box to activate the Delimiter character 1, and enter the Hex code for it. <b>Value Range:</b> 0x00 ~ 0xFF.
<b>Delimiter Character 2</b>	1.An optional filled setting 2.Default value is 0	Check the <b>Enable</b> box to activate the Delimiter character 2, and enter the Hex code for it. <b>Value Range:</b> 0x00 ~ 0xFF.
<b>Data Timeout Transmit</b>	1.An optional filled setting 2.Default value is 0	Enter the data timeout interval for transmitting serial data through the port. By default, it is set to 0 and the timeout function is disabled. <b>Value Range:</b> 0 ~ 1000ms.
<b>Save</b>	N/A	Click the <b>Save</b> button to save the configuration

## Specify Remote TCP Server

Legal Host IP/ FQDN Definition (for TCP Client operation mode)					
ID	To Remote Host	Remote Port	Serial Port	Definition Enable	Action
1		4001	SPort-0	<input type="checkbox"/>	<input type="button" value="Edit"/>
2		4001	SPort-0	<input type="checkbox"/>	<input type="button" value="Edit"/>
3		4001	SPort-0	<input type="checkbox"/>	<input type="button" value="Edit"/>
4		4001	SPort-0	<input type="checkbox"/>	<input type="button" value="Edit"/>

Specify TCP Server Window		
Item	Value setting	Description
<b>To Remote Host</b>	A Must filled setting	Press <b>Edit</b> button to enter IP address or FQDN of the remote TCP server to transmit serial data.
<b>Remote Port</b>	1.A Must filled setting 2.Default value is 4001	Enter the TCP port number. This is the listen port of the remote TCP server. <b>Value Range:</b> 1 ~ 65535.
<b>Serial Port</b>	SPort-0 is set by default	Apply the TCP server connection for a selected serial port. Up to 4 TCP servers can be configured at the same time for each serial port.
<b>Definition Enable</b>	The box is unchecked by default	Check the <b>Enable</b> box to enable the TCP server configuration.
<b>Save</b>	N/A	Click the <b>Save</b> button to save the configuration

# 4G LTE M2M Router

## Enable TCP Server Mode

Configure the gateway as the TCP (Transmission Control Protocol) Server. The TCP Server waits for connections to be initiated by a remote TCP client device to receive serial data. The setting allows user to specify specific TCP clients or allow any to send serial data for serial data transmission bandwidth control and access control. The TCP Server supports up to 128 simultaneous connections to receive serial data from multiple TCP clients.

Operation Mode Definition for each Serial Port									
Serial Port	Operation Mode	Listen Port	Trust Type	Max Connection	Connection Control	Connection Idle Timeout	Alive Check Timeout	Enable	Action
SPort-0	TCP Server ▼	4001 (1~65535)	Allow All ▼	1	Always on ▼	0 (0-3600secs)	0 (0-3600secs)	<input type="checkbox"/>	Edit

Enable TCP Server Mode Window		
Item	Value setting	Description
<b>Operation Mode</b>	A Must filled setting	Select <b>TCP Server</b> mode.
<b>Listen Port</b>	4001 is set by default	Indicate the listening port of TCP connection. <b>Value Range:</b> 1 ~ 65535.
<b>Trust Type</b>	<b>Allow All</b> is set by default	Choose <b>Allow All</b> to allow any TCP clients to connect. Otherwise choose <b>Specific IP</b> to limit certain TCP clients.
<b>Max Connection</b>	1. Max. 128 connections 2. 1 is set by default	Set the maximum number of concurrent TCP connections. Up to 128 simultaneous TCP connections can be established. <b>Value Range:</b> 1 ~ 128.
<b>Connection Idle Timeout</b>	1. 0 is set by default 2. Range 0 to 3600 sec.	Enter the idle timeout in minutes. The idle timeout is used to disconnect the TCP connection when idle time elapsed . Idle timeout is only available when <b>On-Demand</b> is selected in the <b>Connection Control</b> field. <b>Value Range:</b> 0 ~ 3600 seconds.
<b>Alive Check Timeout</b>	1. 0 is set by default 2. Range 0 to 3600 sec.	Enter the time period of alive check timeout. The TCP connection will be terminated if it doesn't receive response of alive-check longer than this timeout setting Alive check timeout is only available when <b>On-Demand</b> is selected in the <b>Connection Control</b> field. <b>Value Range:</b> 0 ~ 3600 seconds.
<b>Enable</b>	The box is unchecked by default.	Check the <b>Enable</b> box to activate the corresponding serial port in specified operation mode.
<b>Save</b>	N/A	Click <b>Save</b> button to save the settings.

# 4G LTE M2M Router

## Specify TCP Clients for TCP Server Access

If you selected **Specific IPs** as the trust Type, the Trusted IP Definition window appears. The settings are valid for both TCP Server and RFC-2217 modes.

Trusted IP Definition (for TCP Server & RFC-2217 operation mode)				
ID	Host	Serial Port	Definition Enable	Action
1			<input type="checkbox"/>	Edit
2			<input type="checkbox"/>	Edit
3			<input type="checkbox"/>	Edit
4			<input type="checkbox"/>	Edit
5			<input type="checkbox"/>	Edit
6			<input type="checkbox"/>	Edit
7			<input type="checkbox"/>	Edit
8			<input type="checkbox"/>	Edit

Specify TCP Clients Window		
Item	Value setting	Description
<b>Host</b>	A Must filled setting	Enter the IP address range of allowed TCP clients.
<b>Serial Port</b>	The box is unchecked by default	Check the box to specify the rule for selected Serial Port.
<b>Definition Enable</b>	The box is unchecked by default	Check the <b>Enable</b> box to enable the rule.
<b>Save</b>	N/A	Click <b>Save</b> to save the settings
<b>Undo</b>	N/A	Click <b>Undo</b> to cancel the settings

# 4G LTE M2M Router

## Enable UDP Mode

UDP (User Datagram Protocol) enables applications using UDP socket programs to communicate with the serial ports on the serial server. The UDP mode provides connectionless communications, which enable you to multicast data from the serial device to multiple host computers, and vice versa, making this mode ideal for message display applications.

Operation Mode Definition for each Serial Port									
Serial Port	Operation Mode	Listen Port	Trust Type	Max Connection	Connection Control	Connection Idle Timeout	Alive Check Timeout	Enable	Action
SPort-0	UDP	4001 (1~65535)	Allow All	1	Always on	0 (0-3600secs)	0 (0-3600secs)	<input type="checkbox"/>	Edit

Enable UDP Mode Window		
Item	Value setting	Description
Operation Mode	A Must filled setting	Select <b>UDP</b> mode.
Listen Port	4001 is set by default	Indicate the listening port of UDP connection. <b>Value Range:</b> 1 ~ 65535
Enable	The box is unchecked by default.	Check the <b>Enable</b> box to activate the corresponding serial port in specified operation mode.
Save	N/A	Click <b>Save</b> to save the settings
Undo	N/A	Click <b>Undo</b> to cancel the settings

## Specify Remote UDP

Legal Host IP Definition (for UDP operation mode)					
ID	Remote Host	Remote Port	Serial Port	Definition Enable	Action
1		4001	SPort-0	<input type="checkbox"/>	Edit
2		4001	SPort-0	<input type="checkbox"/>	Edit
3		4001	SPort-0	<input type="checkbox"/>	Edit
4		4001	SPort-0	<input type="checkbox"/>	Edit

Specify Remote UDP hosts Window		
Item	Value setting	Description
Host	A Must filled setting	Press <b>Edit</b> button to enter IP address range of remote UDP hosts.
Remote Port	4001 is set by default	Indicate the UDP port of peer UDP hosts. <b>Value Range:</b> 1 ~ 65535
Serial Port	SPort-0 is set by default	Apply the UDP hosts for a selected serial port. Up to 4 UDP servers can be configured at the same time for each serial port.
Definition Enable	The box is unchecked by default	Check the <b>Enable</b> box to enable the rule.
Save	N/A	Click <b>Save</b> to save the settings
Undo	N/A	Click <b>Undo</b> to cancel the settings

# 4G LTE M2M Router

## Enable RFC-2217 Mode

RFC-2217 defines general COM port control options based on telnet protocol. With the RFC-2217 mode, remote host can monitor and manage remote serially attached devices, as though they were connected to the local serial port. When a virtual serial port on the local serial device is being created, it is required to specify the IP-address of the remote hosts to establish connection with.

Operation Mode Definition for each Serial Port									
Serial Port	Operation Mode	Listen Port	Trust Type	Max Connection	Connection Control	Connection Idle Timeout	Alive Check Timeout	Enable	Action
SPort-0	RFC-2217 ▼	4001 (1~65535)	Allow All ▼	1	Always on ▼	0 (0-3600secs)	0 (0-3600secs)	<input type="checkbox"/>	Edit

Enable RFC-2217 Mode Window		
Item	Value setting	Description
<b>Operation Mode</b>	A Must filled setting	Select <b>RFC-2217</b> mode.
<b>Listen Port</b>	4001 is set by default	Indicate the listening port of RFC-2217 connection. <b>Value Range:</b> 1 ~ 65535
<b>Trust Type</b>	<b>Allow All</b> is set by default	Choose <b>Allow All</b> to allow any clients to connect. Otherwise choose <b>Specific IP</b> to limit certain clients.
<b>Connection Idle Timeout</b>	1. 0 is set by default 2. Range 0 to 3600 sec.	Enter the idle timeout in minutes. The idle timeout is used to disconnect the TCP connection when idle time elapsed . Idle timeout is only available when <b>On-Demand</b> is selected in the <b>Connection Control</b> field. <b>Value Range:</b> 0 ~ 3600 seconds.
<b>Alive Check Timeout</b>	1. 0 is set by default 2. Range 0 to 3600 sec.	Enter the time period of alive check timeout. The TCP connection will be terminated if it doesn't receive response of alive-check longer than this timeout setting Alive check timeout is only available when <b>On-Demand</b> is selected in the <b>Connection Control</b> field. <b>Value Range:</b> 0 ~ 3600 seconds.
<b>Enable</b>	The box is unchecked by default.	Check the <b>Enable</b> box to activate the corresponding serial port in specified operation mode.
<b>Save</b>	N/A	Click <b>Save</b> to save the settings
<b>Undo</b>	N/A	Click <b>Undo</b> to cancel the settings

# 4G LTE M2M Router

## Specify Remote Host for Access

If you selected **Specific IPs** as the trust Type, the Trusted IP Definition window appears. The settings are valid for both TCP Server and RFC-2217 modes.

Trusted IP Definition (for TCP Server & RFC-2217 operation mode)				
ID	Host	Serial Port	Definition Enable	Action
1			<input type="checkbox"/>	Edit
2			<input type="checkbox"/>	Edit
3			<input type="checkbox"/>	Edit
4			<input type="checkbox"/>	Edit
5			<input type="checkbox"/>	Edit
6			<input type="checkbox"/>	Edit
7			<input type="checkbox"/>	Edit
8			<input type="checkbox"/>	Edit

Specify RFC-2217 Clients for Access Window		
Item	Value setting	Description
<b>Host</b>	A Must filled setting	Enter the IP address range of allowed clients.
<b>Serial Port</b>	The box is unchecked by default	Check the box to specify the rule for selected Serial Port.
<b>Definition Enable</b>	The box is unchecked by default	Check the <b>Enable</b> box to enable the rule.
<b>Save</b>	N/A	Click <b>Save</b> to save the settings
<b>Undo</b>	N/A	Click <b>Undo</b> to cancel the settings

# 4G LTE M2M Router

## Chapter 5 Security

### 5.1 VPN

A virtual private network (VPN) extends a private network across a public network, such as the Internet. It enables a computer to send and receive data across shared or public networks as if it were directly connected to the private network, while benefitting from the functionality, security and management policies of the private network. This is done by establishing a virtual point-to-point connection through the use of dedicated connections, encryption, or a combination of the two. The tunnel technology supports data confidentiality, data origin authentication and data integrity of network information by utilizing encapsulation protocols, encryption algorithms, and hashing algorithms.

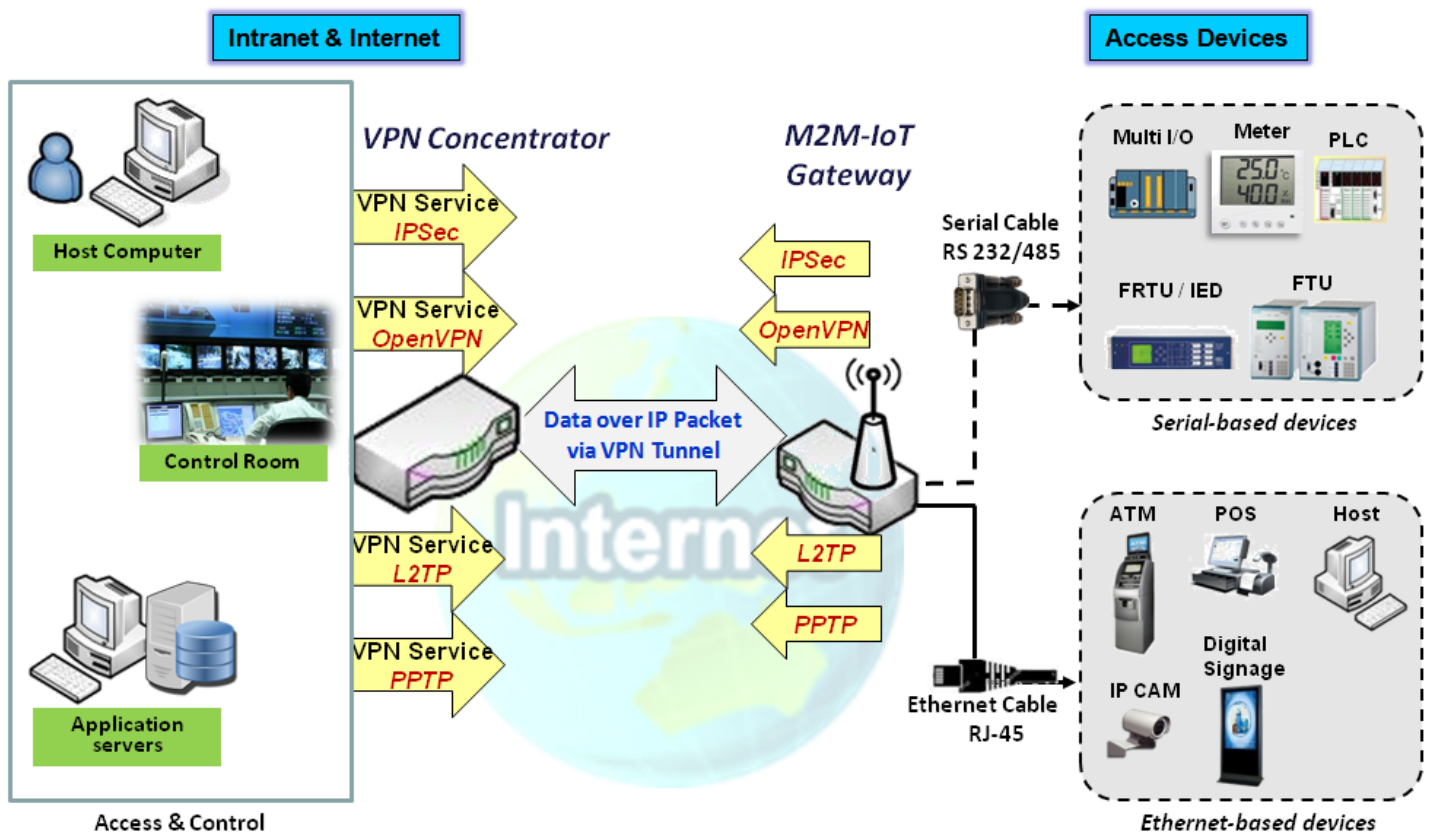

The product series supports different tunneling technologies to establish secure tunnels between multiple sites for data transferring, such as IPSec, OpenVPN, L2TP (over IPSec), PPTP and GRE. Besides, some advanced functions, like Full Tunnel, Tunnel Failover, Tunnel Load Balance, NetBIOS over IPSec, NAT Traversal and Dynamic VPN, are also supported.

# 4G LTE M2M Router

## 5.1.1 IPSec

Internet Protocol Security (IPSec) is a protocol suite for securing Internet Protocol (IP) communications by authenticating and encrypting each IP packet of a communication session. IPSec includes protocols for establishing mutual authentication between agents at the beginning of the session and negotiation of cryptographic keys to be used during the session.

An IPSec VPN tunnel is established between IPSec client and server. Sometimes, we call the IPSec VPN client as the initiator and the IPSec VPN server as the responder. This gateway can be configured as different roles and establish number of tunnels with various remote devices. Before going to setup the VPN connections, you may need to decide the scenario type for the tunneling.

### IPSec Tunnel Scenarios

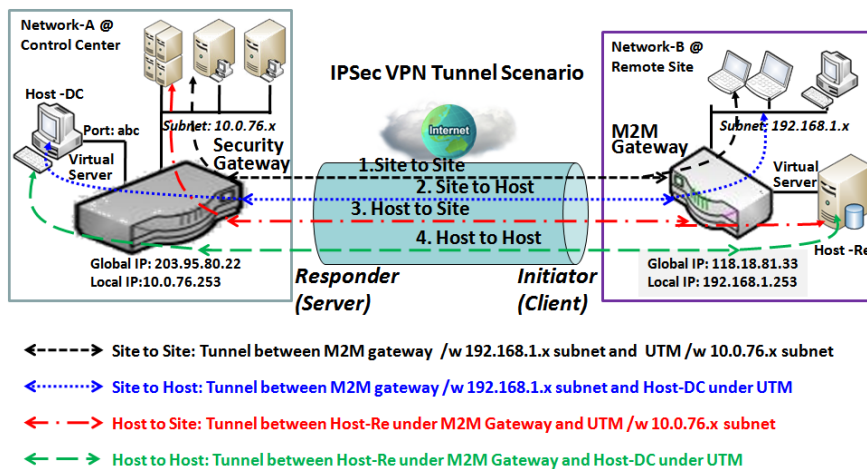

To build IPSec tunnel, you need to fill in remote gateway global IP, and optional subnet if the hosts behind IPSec peer can access to remote site or hosts. Under such configuration, there are four scenarios:

**Site to Site:** You need to setup remote gateway IP and subnet of both gateways. After the IPSec tunnel established, hosts behind both gateways can communication each other through the tunnel.

**Site to Host:** Site to Host is suitable for tunneling between clients in a subnet and an application server (host). As in the diagram, the clients behind the M2M gateway can access to the host "Host-DC" located in the control center through Site to Host VPN tunnel.

**Host to Site:** On the contrast, for a single host (or mobile user to) to access the resources located in an intranet, the Host to Site scenario can be applied.

**Host to Host:** Host to Host is a special configuration for building a VPN tunnel between two single hosts.

# 4G LTE M2M Router

## IPSec Setting

Go to **Security > VPN > IPSec** tab.

The IPSec Setting allows user to create and configure IPSec tunnels.

### Enable IPSec

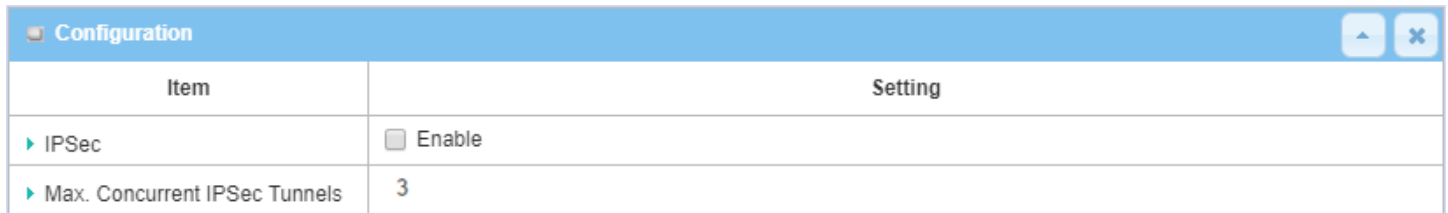

The screenshot shows a configuration window titled "Configuration" with a close button. It contains a table with two rows:

Item	Setting
▶ IPSec	<input type="checkbox"/> Enable
▶ Max. Concurrent IPSec Tunnels	3

Item	Value setting	Description
<b>IPsec</b>	Unchecked by default	Click the <b>Enable</b> box to enable IPSec function.
<b>Max. Concurrent IPSec Tunnels</b>	Depends on Product specification.	The specified value will limit the maximum number of simultaneous IPSec tunnel connection. The default value can be different for the purchased model.
<b>Save</b>	N/A	Click <b>Save</b> to save the settings
<b>Undo</b>	N/A	Click <b>Undo</b> to cancel the settings

### Create/Edit IPSec tunnel

Ensure that the IPSec enable box is checked to enable before further configuring the IPSec tunnel settings.

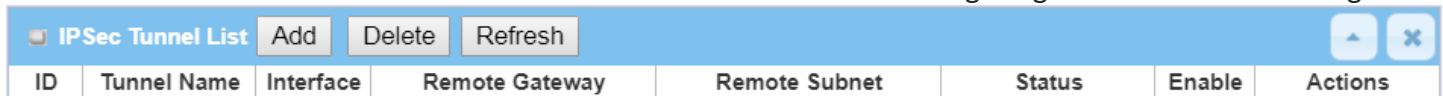

The screenshot shows the "IPSec Tunnel List" interface with buttons for "Add", "Delete", and "Refresh". Below the buttons is a table with the following columns:

ID	Tunnel Name	Interface	Remote Gateway	Remote Subnet	Status	Enable	Actions
----	-------------	-----------	----------------	---------------	--------	--------	---------

When **Add/Edit** button is applied, a series of configuration screens will appear. They are Tunnel Configuration, Local & Remote Configuration, Authentication, IKE Phase, IKE Proposal Definition, IPSec Phase, and IPSec Proposal Definition. You have to configure the tunnel details for both local and remote VPN devices.

# 4G LTE M2M Router

Tunnel Configuration	
Item	Setting
▶ Tunnel	<input type="checkbox"/> Enable
▶ Tunnel Name	IPSec #1
▶ Interface	WAN1 ▼
▶ Tunnel Scenario	Site-to-Site(Tunnel mode) ▼
▶ Tunnel TCP MSS	Auto ▼ 0 (64~1500 Bytes)
▶ Encapsulation Protocol	ESP ▼
▶ IKE Version	v1 ▼

Tunnel Configuration Window		
Item	Value setting	Description
<b>Tunnel</b>	Unchecked by default	Check the <b>Enable</b> box to activate the IPSec tunnel
<b>Tunnel Name</b>	1. A Must fill setting 2. String format can be any text	Enter a tunnel name. Enter a name that is easy for you to identify. <b>Value Range:</b> 1 ~ 19 characters.
<b>Interface</b>	1. A Must fill setting 2. <b>WAN 1</b> is selected by default	Select the interface on which IPSec tunnel is to be established. It can be the available WAN and LAN interfaces.
<b>Tunnel Scenario</b>	1. A Must fill setting 2. <b>Site to site</b> is selected by default	Select an IPSec tunneling scenario from the dropdown box for your application. Select <b>Site-to-Site</b> , <b>Site-to-Host</b> , <b>Host-to-Site</b> , or <b>Host-to-Host</b> . If LAN interface is selected, only <b>Host-to-Host</b> scenario is available.  With <b>Site-to-Site</b> or <b>Site-to-Host</b> or <b>Host-to-Site</b> , IPSec operates in tunnel mode. The difference among them is the number of subnets. With <b>Host-to-Host</b> , IPSec operates in transport mode.
<b>Tunnel TCP MSS</b>	1. An optional setting 2. <b>Auto</b> is set by default	Select from the dropdown box to define the size of Tunnel TCP MSS. Select <b>Auto</b> , and all devices will adjust this parameter automatically. Select <b>Manual</b> , and specify an expected value for Tunnel TCP MSS. <b>Value Range:</b> 64 ~ 1500 bytes.
<b>Encapsulation Protocol</b>	1. A Must fill setting 2. <b>ESP</b> is selected by default	Select the Encapsulation Protocol from the dropdown box for this IPSec tunnel. Available encapsulations are <b>ESP</b> and <b>AH</b> .
<b>IKE Version</b>	1. A Must fill setting 2. <b>v1</b> is selected by default	Specify the IKE version for this IPSec tunnel. Select <b>v1</b> or <b>v2</b> .

# 4G LTE M2M Router

Local & Remote Configuration				
Item	Setting			
▶ Local Subnet List	ID	Subnet IP Address	Subnet Mask	Actions
	1	<input type="text" value="192.168.66.0"/>	<input type="text" value="255.255.255.0/(24)"/>	<input type="button" value="Delete"/>
	<input type="button" value="Add"/>			
▶ Remote Subnet List	ID	Subnet IP Address	Subnet Mask	Actions
	1	<input type="text"/>	<input type="text" value="255.255.255.0/(24)"/>	<input type="button" value="Delete"/>
	<input type="button" value="Add"/>			
▶ Remote Gateway	<input type="text" value=""/> (IP Address/FQDN)			

Local & Remote Configuration Window		
Item	Value setting	Description
<b>Local Subnet List</b>	A Must fill setting	<p>Specify the Local Subnet IP address and Subnet Mask. Click the Add or Delete button to add or delete a Local Subnet.</p> <p>Note_1: When Dynamic VPN option in Tunnel Scenario is selected, there will be only one subnet available. Note_2: When Host-to-Site or Host-to-Host option in Tunnel Scenario is selected, Local Subnet will not be available. Note_3: When Hub and Spoke option in Hub and Spoke is selected, there will be only one subnet available.</p>
<b>Remote Subnet List</b>	A Must fill setting	<p>Specify the Remote Subnet IP address and Subnet Mask. Click the Add or Delete button to add or delete Remote Subnet setting.</p>
<b>Remote Gateway</b>	<ol style="list-style-type: none"> <li>A Must fill setting.</li> <li>Format can be a ipv4 address or FQDN</li> </ol>	Specify the Remote Gateway.

Authentication	
Item	Setting
▶ Key Management	<input type="text" value="IKE+Pre-shared Key"/> (Min. 8 characters)
▶ Local ID	Type: <input type="text" value="User Name"/> ID: <input type="text"/> (Optional)
▶ Remote ID	Type: <input type="text" value="User Name"/> ID: <input type="text"/>

Authentication Configuration Window		
Item	Value setting	Description
<b>Key Management</b>	<ol style="list-style-type: none"> <li>A Must fill setting</li> <li>Pre-shared Key 8 to 32 characters.</li> </ol>	<p>Select Key Management from the dropdown box for this IPsec tunnel. <b>IKE+Pre-shared Key:</b> user needs to set a key (8 ~ 32 characters). <b>IKE+X.509:</b> user needs Certificate to authenticate. IKE+X.509 will be available only when Certificate has been configured properly. Refer to Certificate section of this manual and also <b>Object Definition &gt; Certificate</b> in web-based utility.</p>
<b>Local ID</b>	An optional setting	<p>Specify the Local ID for this IPsec tunnel to authenticate. Select <b>User Name</b> for Local ID and enter the username. The username may include but can't be all numbers. Select <b>FQDN</b> for Local ID and enter the FQDN. Select <b>User@FQDN</b> for Local ID and enter the User@FQDN.</p>

# 4G LTE M2M Router

<b>Remote ID</b>	An optional setting	<p>Select <b>Key ID</b> for Local ID and enter the Key ID (English alphabet or number).</p> <p>Specify the Remote ID for this IPSec tunnel to authenticate.</p> <p>Select <b>User Name</b> for Remote ID and enter the username. The username may include but can't be all numbers.</p> <p>Select <b>FQDN</b> for Local ID and enter the FQDN.</p> <p>Select <b>User@FQDN</b> for Remote ID and enter the User@FQDN.</p> <p>Select <b>Key ID</b> for Remote ID and enter the Key ID (English alphabet or number).</p> <p>Note: Remote ID will be not available when Dynamic VPN option in Tunnel Scenario is selected.</p>
------------------	---------------------	--

# 4G LTE M2M Router

IKE Phase	
Item	Setting
▶ Negotiation Mode	Main Mode
▶ X-Auth	None X-Auth Account (Optional) User Name : Password :
▶ Dead Peer Detection (DPD)	<input checked="" type="checkbox"/> Enable Timeout : 180 (seconds) Delay : 30 (seconds)
▶ Phase1 Key Life Time	3600 (seconds) (Max. 86400)

IKE Phase Window		
Item	Value setting	Description
<b>Negotiation Mode</b>	Main Mode is set by default default	Specify the Negotiation Mode for this IPSec tunnel. Select <b>Main Mode</b> or <b>Aggressive Mode</b> .
<b>X-Auth</b>	None is selected by default	Specify the X-Auth role for this IPSec tunnel. Select Server, Client, or None. Selected None no X-Auth authentication is required. Selected Server this gateway will be an X-Auth server. Click on the X-Auth Account button to create remote X-Auth client account. Selected Client this gateway will be an X-Auth client. Enter User name and Password to be authenticated by the X-Auth server gateway. Note: X-Auth Client will not be available for Dynamic VPN option selected in Tunnel Scenario.
<b>Dead Peer Detection (DPD)</b>	1. Checked by default 2. Default Timeout 180s and Delay 30s	Click <b>Enable</b> box to enable <b>DPD</b> function. Specify the <b>Timeout</b> and <b>Delay</b> time in seconds. <b>Value Range:</b> 0 ~ 999 seconds for <b>Timeout</b> and <b>Delay</b> .
<b>Phase1 Key Life Time</b>	1. A Must fill setting 2. Default 3600s 3. Max. 86400s	Specify the Phase1 Key Life Time. <b>Value Range:</b> 30 ~ 86400.

IKE Proposal Definition				
ID	Encryption	Authentication	DH Group	Definition
1	AES-128	SHA1	Group 2	<input checked="" type="checkbox"/> Enable
2	AES-128	MD5	Group 2	<input checked="" type="checkbox"/> Enable
3	DES	SHA1	Group 2	<input checked="" type="checkbox"/> Enable
4	3DES	SHA1	Group 2	<input checked="" type="checkbox"/> Enable

IKE Proposal Definition Window		
Item	Value setting	Description
IKE Proposal Definition	A Must fill setting	Specify the Phase 1 Encryption method. It can be DES / 3DES / AES-128 / AES-192 / AES-256.  Specify the Authentication method. It can be None / MD5 / SHA1 / SHA2-256.  Specify the DH Group. It can be None / Group1 / Group2 / Group5 / Group14 / Group15 / Group16 / Group17 / Group18.  Check <b>Enable</b> box to enable this setting

# 4G LTE M2M Router

IPSec Phase	
Item	Setting
Phase2 Key Life Time	<input type="text" value="28800"/> (seconds) (Max. 86400)

IPSec Phase Window		
Item	Value setting	Description
Phase2 Key Life Time	1. A Must fill setting 2. 28800s is set by default 3. Max. 86400s	Specify the Phase2 Key Life Time in second. <b>Value Range: 30 ~ 86400.</b>

IPSec Proposal Definition				
ID	Encryption	Authentication	PFS Group	Definition
1	<input type="text" value="AES-128"/>	<input type="text" value="SHA1"/>	<input type="text" value="Group 2"/>	<input checked="" type="checkbox"/> Enable
2	<input type="text" value="AES-128"/>	<input type="text" value="MD5"/>		<input checked="" type="checkbox"/> Enable
3	<input type="text" value="DES"/>	<input type="text" value="SHA1"/>		<input checked="" type="checkbox"/> Enable
4	<input type="text" value="3DES"/>	<input type="text" value="SHA1"/>		<input checked="" type="checkbox"/> Enable

IPSec Proposal Definition Window		
Item	Value setting	Description
IPSec Proposal Definition	A Must fill setting	Specify the Encryption method. It can be DES / 3DES / AES-128 / AES-192 / AES-256. Note: None is available when Encapsulation Protocol is set as <b>AH</b> .  Specify the Authentication method. It can be None / MD5 / SHA1 / SHA2-256. Note: None and SHA2-256 are available only when Encapsulation Protocol is set as <b>ESP</b> ; they are not available for <b>AH</b> Encapsulation.  Specify the PFS Group. It can be None / Group1 / Group2 / Group5 / Group14 / Group15 / Group16 / Group17 / Group18.  Click <b>Enable</b> to enable this setting
Save	N/A	Click <b>Save</b> to save the settings
Undo	N/A	Click <b>Undo</b> to cancel the settings
Back	N/A	Click <b>Back</b> to return to the previous page.

# 4G LTE M2M Router

## 5.1.2 OpenVPN

OpenVPN is an application that implements virtual private network (VPN) techniques for creating secure point-to-point or site-to-site connections in routed or bridged configurations and remote access facilities. It uses a custom security protocol that utilizes SSL/TLS for key exchange. It is capable of traversing network address translators (NATs) and firewalls.

OpenVPN allows peers to authenticate each other using a Static Key (pre-shared key) or certificates. When used in a multi-client-server configuration, it allows the server to release an authentication certificate for every client, using signature and certificate authority. It uses the OpenSSL encryption library extensively, as well as the SSLv3/TLSv1 protocol, and contains many security and control features.

OpenVPN Tunneling is a Client and Server based tunneling technology. The OpenVPN Server must have a Static IP or a FQDN, and maintain a Client list. The OpenVPN Client may be a mobile user or mobile site with public IP or private IP, and requesting the OpenVPN tunnel connection. The product can only behave as a OpenVPN Client role for an OpenVPN tunnel connection.

There are two OpenVPN connection scenarios. They are the TAP and TUN scenarios. The product can create either a layer-3 based IP tunnel (TUN), or a layer-2 based Ethernet TAP that can carry any type of Ethernet traffic. In addition to configuring the device as a Server or Client, you have to specify which type of OpenVPN connection scenario is to be adopted.

### OpenVPN TUN Scenario

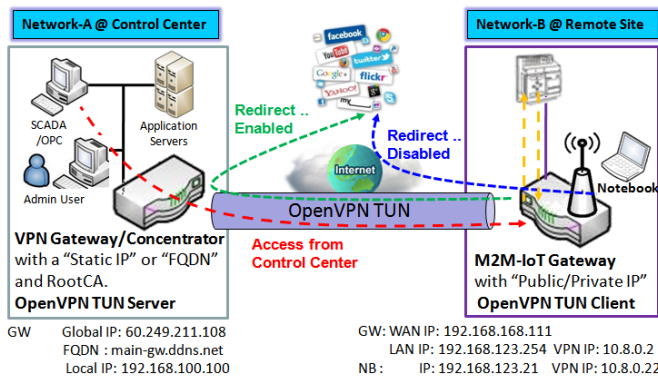

1. M2M-IoT Gateway (as OpenVPN TUN Client) connects to peer VPN Gateway/Concentrator (as OpenVPN TUN Server).
2. M2M-IoT Gateway will be assigned 10.8.0.2 IP Address after OpenVPN TUN Connection established. (10.8.0.x is a virtual subnet)
3. Local networked device will get a virtual IP 10.8.0.x if its traffic goes through the OpenVPN TUN connection (when NAT disabled & Redirect Internet Traffic enabled).
4. SCADA Server in Control Center can access remote attached device(s) with the assigned IP Address 10.8.0.2.

solution.

The term "TUN" mode is referred to routing mode and operates with layer 3 packets. In routing mode, the VPN client is given an IP address on a different subnet than the local LAN under the OpenVPN server. This virtual subnet is created for connecting to any remote VPN computers. In routing mode, the OpenVPN server creates a "TUN" interface with its own IP address pool which is different to the local LAN. Remote hosts that dial-in will get an IP address inside the virtual network and will have access only to the server where OpenVPN resides.

If you want to offer remote access to a VPN server from client(s), and inhibit the access to remote LAN resources under VPN server, OpenVPN TUN mode is the simplest

As shown in the diagram, the M2M-IoT Gateway is configured as an OpenVPN TUN Client, and connects to an

# 4G LTE M2M Router

OpenVPN UN Server. Once the OpenVPN TUN connection is established, the connected TUN client will be assigned a virtual IP (10.8.0.2) which is belong to a virtual subnet that is different to the local subnet in Control Center. With such connection, the local networked devices will get a virtual IP 10.8.0.x if its traffic goes through the OpenVPN TUN connection when Redirect Internet Traffic settings is enabled; Besides, the SCADA Server in Control Center can access remote attached serial device(s) with the virtual IP address (10.8.0.2).

## OpenVPN TAP Scenario

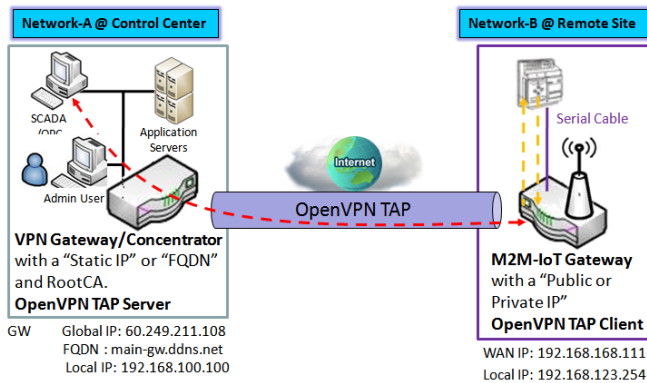

1. M2M-IoT Gateway (as OpenVPN TAP Client) connects to peer VPN Gateway/Concentrator (as OpenVPN TAP Server).
2. M2M-IoT Gateway will be assigned **192.168.100.210** IP Address after OpenVPN TAP Connection established. **(same subnet as in Control Center)**
3. SCADA Server in Control Center can access remote attached device(s) with the assigned IP Address 192.168.100.210.

The term "TAP" is referred to bridge mode and operates with layer 2 packets. In bridge mode, the VPN client is given an IP address on the same subnet as the LAN resided under the OpenVPN server. Under such configuration, the OpenVPN client can directly access to the resources in LAN. If you want to offer remote access to the entire remote LAN for VPN client(s), you have to setup OpenVPN in "TAP" bridge mode.

As shown in the diagram, the M2M-IoT Gateway is configured as an OpenVPN TAP Client, and connects to an OpenVPN TAP Server. Once the OpenVPN TAP connection is established, the connected TAP client will be assigned a virtual IP (192.168.100.210) which is the same subnet as

that of local subnet in Control Center. With such connection, the SCADA Server in Control Center can access remote attached serial device(s) with the virtual IP address (192.168.100.210).

# 4G LTE M2M Router

## Open VPN Setting

Go to **Security > VPN > OpenVPN** tab.

The OpenVPN setting allows user to create and configure OpenVPN tunnels.

### Enable OpenVPN

Configuration	
Item	Setting
▶ OpenVPN	<input type="checkbox"/> Enable
▶ Client	Client ▾
▶ OpenVPN Configuration file	<input type="checkbox"/> Enable <input type="button" value="Upgrade"/>

Configuration		
Item	Value setting	Description
<b>OpenVPN</b>	The box is unchecked by default	Check the <b>Enable</b> box to activate the OpenVPN function.
<b>Client</b>	<b>Client</b> is selected by default.	Only <b>Client</b> is available, you can specify the client settings in another client configuration window.
<b>OpenVPN Configuration file</b>	1. An Optional setting. 2. The box is unchecked by default.	Click the <b>Enable</b> box to activate the OpenVPN Client configuration via a pre-defined <b>.ovpn</b> configuration file. You have to further click the <b>Upgrade</b> button to upload the configuration from a <b>.ovpn</b> file.  If you enabled this function, you can't add any OpenVPN clients manually.

### Create/Edit OpenVPN Client

OpenVPN Client List														
ID	Client Name	Interface	Protocol	Port	Tunnel Scenario	Remote IP/FQDN	Remote Subnet	Redirect Internet Traffic	NAT	Authorization Mode	Encryption Cipher	Hash Algorithm	Enable	Actions

When **Add** button is applied, OpenVPN Client Configuration screen will appear. **OpenVPN Client Configuration** window let you specify the required parameters for an OpenVPN VPN client, such as "OpenVPN Client Name", "Interface", "Protocol", "Tunnel Scenario", "Remote IP/FQDN", "Remote Subnet", "Authorization Mode", "Encryption Cipher", "Hash Algorithm" and tunnel activation.

# 4G LTE M2M Router

OpenVPN Client Configuration	
Item	Setting
▶ OpenVPN Client Name	OpenVPN Client #1
▶ Interface	WAN 1 ▼
▶ Protocol	TCP ▼ Port: 443
▶ Tunnel Scenario	TUN ▼
▶ Remote IP/FQDN	
▶ Remote Subnet	<input type="checkbox"/> Enable <input type="text"/> 255.255.255.0(/24) ▼
▶ Redirect Internet Traffic	<input type="checkbox"/> Enable
▶ NAT	<input checked="" type="checkbox"/> Enable
▶ Authorization Mode	TLS ▼ CA Cert.: ▼ Client Cert.: ▼ Client Key.: ▼ <span style="color: red;">Please set the Certificate.</span>
▶ Encryption Cipher	Blowfish ▼
▶ Hash Algorithm	SHA-1 ▼
▶ LZO Compression	Adaptive ▼
▶ Persist Key	<input checked="" type="checkbox"/> Enable
▶ Persist Tun	<input checked="" type="checkbox"/> Enable
▶ Advanced Configuration	<input type="button" value="Edit"/>
▶ Tunnel	<input type="checkbox"/> Enable

OpenVPN Client Configuration		
Item	Value setting	Description
<b>OpenVPN Client Name</b>	A Must filled setting	The <b>OpenVPN Client Name</b> will be used to identify the client in the tunnel list. <span style="color: red;"><b>Value Range: 1 ~ 32 characters.</b></span>
<b>Interface</b>	1. A Must filled setting 2. By default <b>WAN-1</b> is selected.	Define the physical interface to be used for this OpenVPN Client tunnel.
<b>Protocol</b>	1. A Must filled setting 2. By default <b>TCP</b> is selected.	Define the <b>Protocol</b> for the OpenVPN Client. <ul style="list-style-type: none"> <li>• Select <b>TCP</b> -&gt;The OpenVPN will use TCP protocol, and <b>Port</b> will be set as 443 automatically.</li> <li>• Select <b>UDP</b> -&gt; The OpenVPN will use UDP protocol, and <b>Port</b> will be set as 1194 automatically.</li> </ul>
<b>Port</b>	1. A Must filled setting 2. By default <b>443</b> is set.	Specify the <b>Port</b> for the OpenVPN Client to use. <span style="color: red;"><b>Value Range: 1 ~ 65535.</b></span>
<b>Tunnel Scenario</b>	1. A Must filled setting 2. By default <b>TUN</b> is selected.	Specify the type of <b>Tunnel Scenario</b> for the OpenVPN Client to use. It can be <b>TUN</b> for TUN tunnel scenario, or <b>TAP</b> for TAP tunnel scenario.
<b>Remote IP/FQDN</b>	A Must filled setting	Specify the <b>Remote IP/FQDN</b> of the peer OpenVPN Server for this OpenVPN Client tunnel. Fill in the IP address or FQDN.
<b>Remote Subnet</b>	1. An Optional setting. 2. The box is unchecked by default.	Check the <b>Enable</b> box to activate remote subnet function, and specify <b>Remote Subnet</b> of the peer OpenVPN Server for this OpenVPN Client tunnel. Fill in the remote subnet address and remote subnet mask.
<b>Redirect Internet Traffic</b>	1. An Optional setting. 2. The box is unchecked by default.	Check the <b>Enable</b> box to activate the <b>Redirect Internet Traffic</b> function.

# 4G LTE M2M Router

<b>NAT</b>	1. An Optional setting. 2. The box is checked by default.	Check the <b>Enable</b> box to activate the <b>NAT</b> function.
<b>Authorization Mode</b>	1. A Must filled setting 2. By default <b>TLS</b> is selected.	Specify the authorization mode for the OpenVPN Server. <ul style="list-style-type: none"> <li>• <b>TLS</b> -&gt;The OpenVPN will use TLS authorization mode, and the following items <b>CA Cert.</b>, <b>Client Cert.</b> and <b>Client Key</b> will be displayed. <b>CA Cert.</b> could be selected in Trusted CA Certificate List. Refer to <b>Object Definition &gt; Certificate &gt; Trusted Certificate.</b> <b>Client Cert.</b> could be selected in Local Certificate List. Refer to <b>Object Definition &gt; Certificate &gt; My Certificate.</b> <b>Client Key</b> could be selected in Trusted Client key List. Refer to <b>Object Definition &gt; Certificate &gt; Trusted Certificate.</b></li> <li>• <b>Static Key</b> -&gt;The OpenVPN will use static key authorization mode, and the following items <b>Local Endpoint IP Address</b>, <b>Remote Endpoint IP Address</b> and <b>Static Key</b> will be displayed.</li> </ul>
<b>Local Endpoint IP Address</b>	A Must filled setting	Specify the virtual <b>Local Endpoint IP Address</b> of this OpenVPN gateway. <b>Value Range:</b> The IP format is 10.8.0.x, the range of x is 1~254. Note: Local Endpoint IP Address will be available only when Static Key is chosen in Authorization Mode.
<b>Remote Endpoint IP Address</b>	A Must filled setting	Specify the virtual <b>Remote Endpoint IP Address</b> of the peer OpenVPN gateway. <b>Value Range:</b> The IP format is 10.8.0.x, the range of x is 1~254. Note: Remote Endpoint IP Address will be available only when Static Key is chosen in Authorization Mode.
<b>Static Key</b>	A Must filled setting	Specify the <b>Static Key</b> . Note: Static Key will be available only when Static Key is chosen in Authorization Mode.
<b>Encryption Cipher</b>	By default <b>Blowfish</b> is selected.	Specify the <b>Encryption Cipher</b> . It can be <b>Blowfish/AES-256/AES-192/AES-128/None</b> .
<b>Hash Algorithm</b>	By default <b>SHA-1</b> is selected.	Specify the <b>Hash Algorithm</b> . It can be <b>SHA-1/MD5/MD4/SHA2-256/SHA2-512/None/Disable</b> .
<b>LZO Compression</b>	By default <b>Adaptive</b> is selected.	Specify the <b>LZO Compression</b> scheme. It can be <b>Adaptive/YES/NO/Default</b> .
<b>Persis Key</b>	1. An Optional setting. 2. The box is checked by default.	Check the <b>Enable</b> box to activate the <b>Persis Key</b> function.
<b>Persis Tun</b>	1. An Optional setting. 2. The box is checked by default.	Check the <b>Enable</b> box to activate the <b>Persis Tun</b> function.
<b>Advanced Configuration</b>	N/A	Click the <b>Edit</b> button to specify the <b>Advanced Configuration</b> setting for the OpenVPN server. If the button is clicked, <b>Advanced Configuration</b> will be displayed below.
<b>Tunnel</b>	The box is unchecked by default	Check the <b>Enable</b> box to activate this OpenVPN tunnel.
<b>Save</b>	N/A	Click <b>Save</b> to save the settings.
<b>Undo</b>	N/A	Click <b>X</b> to cancel the changes and return to last page.

# 4G LTE M2M Router

When **Advanced Configuration** is selected, an OpenVPN Client Advanced Configuration screen will appear.

OpenVPN Client Advanced Configuration	
Item	Setting
▶ TLS Cipher	None ▼
▶ TLS Auth. Key(Optional)	<input type="text"/> (Optional)
▶ User Name(Optional)	<input type="text"/> (Optional)
▶ Password(Optional)	<input type="text"/> (Optional)
▶ Bridge TAP to	VLAN 1 ▼
▶ Firewall Protection	<input type="checkbox"/> Enable
▶ Client IP Address	Dynamic IP ▼
▶ Tunnel MTU	1500
▶ Tunnel UDP Fragment	1500
▶ Tunnel UDP MSS-Fix	<input type="checkbox"/> Enable
▶ nsCertType Verification	<input type="checkbox"/> Enable
▶ TLS Renegotiation Time(seconds)	3600 (seconds)
▶ Connection Retry(seconds)	-1 (seconds)
▶ DNS	Automatically ▼
▶ Additional Configuration	<input type="text"/>

OpenVPN Advanced Client Configuration		
Item	Value setting	Description
<b>TLS Cipher</b>	1. A Must filled setting. 2. <b>TLS-RSA-WITH-AES128-SHA</b> is selected by default	Specify the <b>TLS Cipher</b> from the dropdown list. It can be <b>None / TLS-RSA-WITH-RC4-MD5 / TLS-RSA-WITH-AES128-SHA / TLS-RSA-WITH-AES256-SHA / TLS-DHE-DSS-AES128-SHA / TLS-DHE-DSS-AES256-SHA</b> . Note: TLS Cipher will be available only when TLS is chosen in Authorization Mode.
<b>TLS Auth. Key</b>	1. An Optional setting. 2. String format: any text	Specify the <b>TLS Auth. Key</b> for connecting to an OpenVPN server, if the server required it. Note: TLS Auth. Key will be available only when TLS is chosen in Authorization Mode.
<b>User Name</b>	An Optional setting.	Enter the <b>User account</b> for connecting to an OpenVPN server, if the server required it. Note: User Name will be available only when TLS is chosen in Authorization Mode.
<b>Password</b>	An Optional setting.	Enter the <b>Password</b> for connecting to an OpenVPN server, if the server required it. Note: User Name will be available only when TLS is chosen in Authorization Mode.
<b>Bridge TAP to</b>	By default <b>VLAN 1</b> is selected	Specify the setting of <b>"Bridge TAP to"</b> to bridge the TAP interface to a certain local network interface or VLAN. Note: Bridge TAP to will be available only when TAP is chosen in Tunnel Scenario and NAT is unchecked.
<b>Firewall Protection</b>	The box is unchecked by default.	Check the box to activate the <b>Firewall Protection</b> function. Note: Firewall Protection will be available only when NAT is enabled.

# 4G LTE M2M Router

<b>Client IP Address</b>	By default <b>Dynamic IP</b> is selected	Specify the virtual IP Address for the OpenVPN Client. It can be <b>Dynamic IP/Static IP</b> .
<b>Tunnel MTU</b>	1.A Must filled setting 2.The value is 1500 by default	Specify the value of <b>Tunnel MTU</b> . <b>Value Range: 0 ~ 1500.</b>
<b>Tunnel UDP Fragment</b>	The value is 1500 by default	Specify the value of <b>Tunnel UDP Fragment</b> . <b>Value Range: 0 ~ 1500.</b> Note: Tunnel UDP Fragment will be available only when UDP is chosen in Protocol.
<b>Tunnel UDP MSS-Fix</b>	The box is unchecked by default.	Check the <b>Enable</b> box to activate the <b>Tunnel UDP MSS-Fix</b> function. Note: Tunnel UDP MSS-Fix will be available only when UDP is chosen in Protocol.
<b>nsCerType Verification</b>	The box is unchecked by default.	Check the <b>Enable</b> box to activate the <b>nsCerType Verification</b> function. Note: nsCerType Verification will be available only when TLS is chosen in Authorization Mode.
<b>TLS Renegotiation Time (seconds)</b>	The value is 3600 by default	Specify the time interval of <b>TLS Renegotiation Time</b> . <b>Value Range: -1 ~ 86400.</b>
<b>Connection Retry(seconds)</b>	The value is -1 by default	Specify the time interval of <b>Connection Retry</b> . The default -1 means that it is no need to execute connection retry. <b>Value Range: -1 ~ 86400, and -1 means no retry is required.</b>
<b>DNS</b>	By default <b>Automatically</b> is selected	Specify the setting of <b>DNS</b> . It can be <b>Automatically/Manually</b> .
<b>Additional Configuration</b>	An Optional setting.	Enter optional configuration string here. Up to 256 characters is allowable. <b>Value Range: 0 ~ 256characters.</b>
<b>Save</b>	N/A	Click <b>Save</b> to save the settings.
<b>Undo</b>	N/A	Click <b>X</b> to cancel the changes and return to last page.

# 4G LTE M2M Router

## 5.1.3 L2TP

Configuration	
Item	Setting
L2TP	<input type="checkbox"/> Enable
Client	Client ▾

L2TP Client Configuration	
Item	Setting
L2TP Client	<input type="checkbox"/> Enable

L2TP Client List & Status								
ID	Tunnel Name	Interface	Virtual IP	Remote IP/FQDN	Remote Subnet	Status	Enable	Actions
<div style="text-align: right;"> <input type="button" value="Add"/> <input type="button" value="Delete"/> <input type="button" value="Refresh"/> </div>								

Layer 2 Tunneling Protocol (L2TP) is a tunneling protocol used to support virtual private networks (VPNs) or as part of the delivery of services by ISPs. It does not provide any encryption or confidentiality by itself. Rather, it relies on an encryption protocol that it passes within the tunnel to provide privacy. This Gateway can only behave as a L2TP client for a L2TP VPN tunnel.

**L2TP Client:** It can be mobile users or gateways in remote offices with dynamic IP. To setup tunnel, it should get “user name”, “password” and server’s global IP. In addition, it is required to identify the operation mode for each tunnel as main connection, failover for another tunnel, or load balance tunnel to increase overall bandwidth. It needs to decide “Default Gateway” or “Remote Subnet” for packet flow. Moreover, you can also define what kind of traffics will pass through the L2TP tunnel in the “Default Gateway / Remote Subnet” parameter.

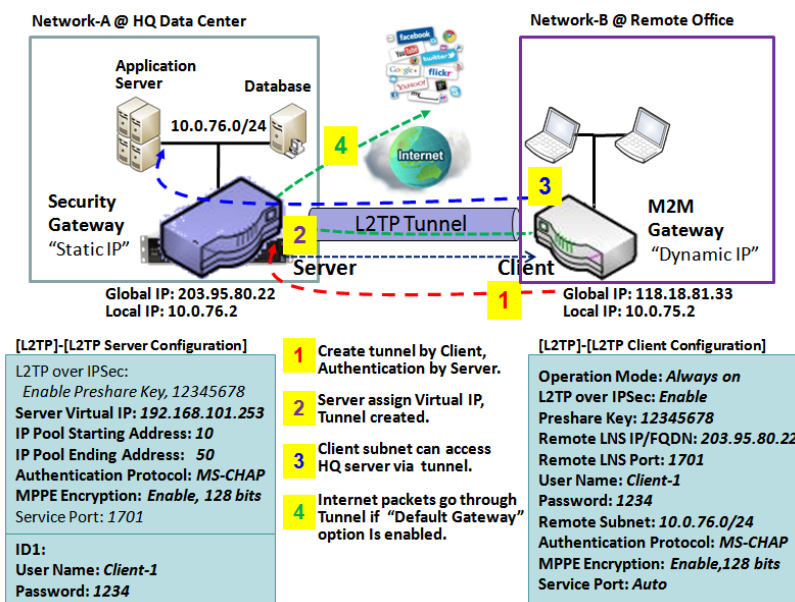

Besides, for the L2TP client peer, a Remote Subnet item is required. It is for the Intranet of L2TP server peer. So, at L2TP client peer, the packets whose destination is in the dedicated subnet will be transferred via the L2TP tunnel. Others will be transferred based on current routing policy of the gateway at L2TP client peer. But, if you entered 0.0.0.0/0 in the Remote Subnet field, it will be treated as a "Default Gateway" setting for the L2TP client peer, all packets, including the Internet accessing of L2TP client peer, will go through the established L2TP tunnel. That means the remote L2TP server peer controls the flow of any packets from the L2TP client peer.

# 4G LTE M2M Router

Certainly, those packets come through the L2TP tunnel.

## L2TP Setting

Go to **Security > VPN > L2TP** tab.

The L2TP setting allows user to create and configure L2TP tunnels.

### Enable L2TP

Configuration	
Item	Setting
L2TP	<input type="checkbox"/> Enable
Client	Client ▾

Enable L2TP Window		
Item	Value setting	Description
L2TP	Unchecked by default	Click the <b>Enable</b> box to activate L2TP function.
Client	A Must filled setting	Specify the role of L2TP. Only <b>Client</b> role is available for this gateway. Below are the configuration windows for L2TP Client.
Save	N/A	Click <b>Save</b> button to save the settings

### As a L2TP Client

L2TP Client Configuration	
Item	Setting
L2TP Client	<input type="checkbox"/> Enable

L2TP Client Configuration		
Item Setting	Value setting	Description
L2TP Client	The box is unchecked by default	Check the <b>Enable</b> box to enable L2TP client role of the gateway.
Save	N/A	Click <b>Save</b> button to save the settings.
Undo	N/A	Click <b>Undo</b> button to cancel the settings.

### Create/Edit L2TP Client

# 4G LTE M2M Router

L2TP Client List & Status								
ID	Tunnel Name	Interface	Virtual IP	Remote IP/FQDN	Remote Subnet	Status	Enable	Actions
1	L2TP #1	WAN 1	0.0.0.0	192.168.127.72			<input type="checkbox"/>	<input type="button" value="Edit"/> <input type="checkbox"/> Select

When **Add/Edit** button is applied, a series of configuration screen will appear. You can add up to 8 L2TP Clients.

L2TP Client Configuration	
Item	Setting
▶ Tunnel Name	<input type="text" value="L2TP #1"/>
▶ Interface	<input type="text" value="WAN1"/>
▶ L2TP over IPsec	<input type="checkbox"/> Enable Preshared Key <input type="text" value=""/> (Min. 8 characters)
▶ Remote LNS IP/FQDN	<input type="text"/>
▶ MTU	<input type="text" value="1500"/>
▶ Remote LNS Port	<input type="text" value="1701"/>
▶ User Name	<input type="text"/>
▶ Password	<input type="text"/>
▶ Tunneling Password (Optional)	<input type="text"/>
▶ Remote Subnet	<input type="text"/>
▶ Authentication Protocol	<input type="checkbox"/> PAP <input type="checkbox"/> CHAP <input type="checkbox"/> MS-CHAP <input type="checkbox"/> MS-CHAP v2
▶ MPPE Encryption	<input type="checkbox"/> Enable
▶ NAT before Tunneling	<input type="checkbox"/> Enable
▶ LCP Echo Type	<input type="text" value="Auto"/>
	Interval <input type="text" value="30"/> seconds Max. Failure Time <input type="text" value="6"/> times
▶ Service Port	<input type="text" value="Auto"/> <input type="text" value="0"/>
▶ Tunnel	<input type="checkbox"/> Enable

L2TP Client Configuration		
Item	Setting	Description
<b>Tunnel Name</b>	A Must filled setting	Enter a tunnel name. Enter a name that is easy for you to identify. <b>Value Range:</b> 1 ~ 32 characters.
<b>Interface</b>	A Must filled setting	Define the selected interface to be the used for this L2TP tunnel (WAN-1 is available only when WAN-1 interface is enabled) The same applies to other WAN interfaces (e.g. WAN-2).
<b>L2TP over IPsec</b>	The box is unchecked by default	Check the <b>Enable</b> box to activate L2TP over IPsec, and further specify a Pre-shared Key (8~32 characters).
<b>Remote LNS IP/FQDN</b>	A Must filled setting	Enter the public IP address or the FQDN of the L2TP server.
<b>MTU</b>	1.A Must filled setting 2.The value is 1500 by default	Specify the <b>MTU</b> . <b>Value Range:</b> 0 ~ 1500.
<b>Remote LNS Port</b>	1. A Must filled setting	Enter the Remote LNS Port for this L2TP tunnel.

# 4G LTE M2M Router

	2. <b>1701</b> is set by default	<b><u>Value Range:</u></b> 1 ~ 65535.
<b>User Name</b>	A Must filled setting	Enter the <b>User Name</b> for this L2TP tunnel to be authenticated when connect to L2TP server. <b><u>Value Range:</u></b> 1 ~ 32 characters.
<b>Password</b>	A Must filled setting	Enter the <b>Password</b> for this L2TP tunnel to be authenticated when connect to L2TP server.
<b>Tunneling Password(Optional)</b>	An Optional filled setting	Enter the <b>Tunneling Password</b> for this L2TP tunnel to authenticate.
<b>Remote Subnet</b>	A Must filled setting	Specify the remote subnet for this L2TP tunnel to reach L2TP server. The Remote Subnet format must be IP address/netmask (e.g. 10.0.0.2/24). It is for the Intranet of L2TP VPN server. So, at L2TP client peer, the packets whose destination is in the dedicated subnet will be transferred via the L2TP VPN tunnel. Others will be transferred based on current routing policy of the security gateway at L2TP client peer. If you entered 0.0.0.0/0 in the Remote Subnet field, it will be treated as a default gateway setting for the L2TP client peer, all packets, including the Internet accessing of L2TP Client peer, will go through the established L2TP VPN tunnel. That means the remote L2TP VPN server controls the flow of any packets from the L2TP client peer. Certainly, those packets come through the L2TP VPN tunnel.
<b>Authentication Protocol</b>	1. A Must filled setting 2. Unchecked by default	Specify one ore multiple <b>Authentication Protocol</b> for this L2TP tunnel. Available authentication methods are <b>PAP / CHAP / MS-CHAP / MS-CHAP v2</b> .
<b>MPPE Encryption</b>	1. Unchecked by default 2. an optional setting	Specify whether L2TP server supports <b>MPPE Protocol</b> . Click the <b>Enable</b> box to enable MPPE. Note: when MPPE Encryption is enabled, the Authentication Protocol <b>PAP / CHAP</b> options will not be available.
<b>NAT before Tunneling</b>	1. A Must filled setting 2. Unchecked by default	Specify whether NAT is required or not for this L2TP tunnel.
<b>LCP Echo Type</b>	1. Auto is set by default	Specify the LCP Echo Type for this L2TP tunnel. It can be <b>Auto, User-defined, or Disable</b> . <b>Auto:</b> the system sets the Interval and Max. Failure Time. <b>User-defined:</b> enter the Interval and Max. Failure Time. The default value for Interval is 30 seconds, and Maximum Failure Times is 6 Times. <b>Disable:</b> disable the LCP Echo. <b><u>Value Range:</u></b> 1 ~ 99999 for Interval Time, 1~999 for Failure Time.
<b>Service Port</b>	A Must filled setting	Specify the <b>Service Port</b> for this L2TP tunnel to use. It can be <b>Auto, (1701) for Cisco, or User-defined</b> . <b>Auto:</b> The system determines the service port. <b>1701 (for Cisco):</b> The system use port 1701 for connecting with CISCO L2TP Server. <b>User-defined:</b> Enter the service port. The default value is 0. <b><u>Value Range:</u></b> 0 ~ 65535.
<b>Tunnel</b>	Unchecked by default	Check the <b>Enable</b> box to enable this L2TP tunnel.

# 4G LTE M2M Router

<b>Save</b>	N/A	Click <b>Save</b> button to save the settings.
<b>Undo</b>	N/A	Click <b>X</b> button to cancel the settings and back to last page.

# 4G LTE M2M Router

## 5.1.4 PPTP

Configuration	
Item	Setting
PPTP	<input type="checkbox"/> Enable
Client	Client ▾

PPTP Client Configuration	
Item	Setting
PPTP Client	<input type="checkbox"/> Enable

PPTP Client List & Status								
ID	Tunnel Name	Interface	Virtual IP	Remote IP/FQDN	Remote Subnet	Status	Enable	Actions
<div style="display: flex; justify-content: space-between; align-items: center;"> <span>Add</span> <span>Delete</span> <span>Refresh</span> </div>								

Point-to-Point Tunneling Protocol (PPTP) is a method for implementing virtual private networks. PPTP uses a control channel over TCP and a GRE tunnel operating to encapsulate PPP packets. It is a client-server based technology. There are various levels of authentication and encryption for PPTP tunneling, usually natively as standard features of the Windows PPTP stack. The security gateway can only play "PPTP Client" role for a PPTP VPN tunnel. PPTP tunnel process is nearly the same as L2TP.

**PPTP Client:** It can be mobile users or gateways in remote offices with dynamic IP. To setup tunnel, it should get "user name", "password" and server's global IP. In addition, it is required to identify the operation mode for each tunnel as main connection, failover for another tunnel, or load balance tunnel to increase overall bandwidth. It needs to decide "Default Gateway" or "Remote Subnet" for packet flow. Moreover, you can also define what kind of traffics will pass through the PPTP tunnel in the "Default Gateway / Remote Subnet" parameter.

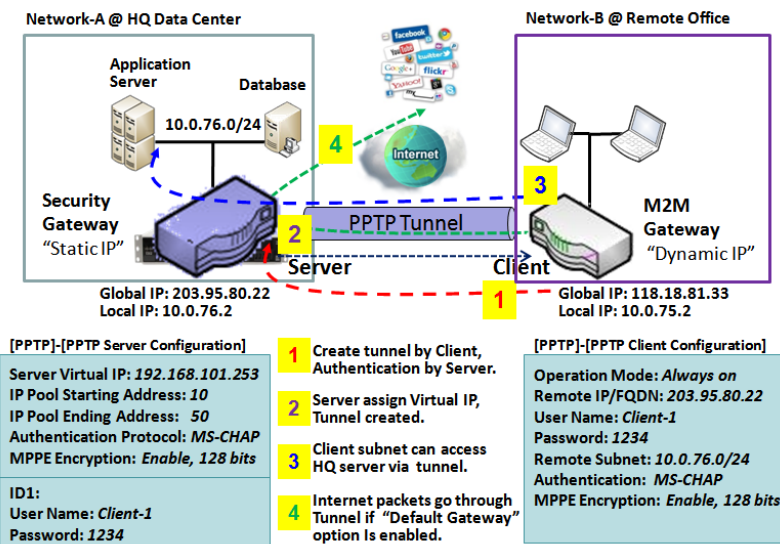

Besides, for the PPTP client peer, a Remote Subnet item is required. It is for the Intranet of PPTP server peer. So, at PPTP client peer, the packets whose destination is in the dedicated subnet will be transferred via the PPTP tunnel. Others will be transferred based on current routing policy of the gateway at PPTP client peer. But, if you entered 0.0.0.0/0 in the Remote Subnet field, it will be treated as a "Default Gateway" setting for the PPTP client peer, all packets, including the Internet accessing of PPTP client peer, will go through the established PPTP tunnel. That means the remote PPTP server peer controls the flow of

# 4G LTE M2M Router

any packets from the PPTP client peer. Certainly, those packets come through the PPTP tunnel.

## PPTP Setting

---

Go to **Security > VPN > PPTP** tab.

The PPTP setting allows user to create and configure PPTP tunnels.

### Enable PPTP

Configuration	
Item	Setting
▶ PPTP	<input type="checkbox"/> Enable
▶ Client	Client ▾

Enable PPTP Window		
Item	Value setting	Description
<b>PPTP</b>	Unchecked by default	Click the <b>Enable</b> box to activate PPTP function.
<b>Client</b>	A Must fill setting	Specify the role of PPTP. Only <b>Client</b> role is available for this gateway. Below are the configuration windows for PPTP Client.
<b>Save</b>	N/A	Click <b>Save</b> button to save the settings.

### As a PPTP Client

PPTP Client Configuration	
Item	Setting
▶ PPTP Client	<input type="checkbox"/> Enable

PPTP Client Configuration		
Item	Value setting	Description
<b>PPTP Client</b>	Unchecked by default	Check the <b>Enable</b> box to enable PPTP client role of the gateway.
<b>Save</b>	N/A	Click <b>Save</b> button to save the settings.
<b>Undo</b>	N/A	Click <b>Undo</b> button to cancel the settings.

### Create/Edit PPTP Client

# 4G LTE M2M Router

PPTP Client List & Status <span>Add</span> <span>Delete</span> <span>Refresh</span>								
ID	Tunnel Name	Interface	Virtual IP	Remote IP/FQDN	Remote Subnet	Status	Enable	Actions

When **Add/Edit** button is applied, a series PPTP Client Configuration will appear.

PPTP Client Configuration	
Item	Setting
▶ Tunnel Name	<input type="text" value="PPTP #1"/>
▶ Interface	<input type="text" value="WAN1"/>
▶ Remote IP/FQDN	<input type="text"/>
▶ MTU	<input type="text" value="1500"/>
▶ User Name	<input type="text"/>
▶ Password	<input type="text"/>
▶ Remote Subnet	<input type="text"/>
▶ Authentication Protocol	<input type="checkbox"/> PAP <input type="checkbox"/> CHAP <input type="checkbox"/> MS-CHAP <input type="checkbox"/> MS-CHAP v2
▶ MPPE Encryption	<input type="checkbox"/> Enable
▶ NAT before Tunneling	<input type="checkbox"/> Enable
▶ LCP Echo Type	<input type="text" value="Auto"/> Interval <input type="text" value="30"/> seconds Max. Failure Time <input type="text" value="6"/> times
▶ Tunnel	<input type="checkbox"/> Enable

PPTP Client Configuration Window		
Item	Value setting	Description
<b>Tunnel Name</b>	A Must fill setting	Enter a tunnel name. Enter a name that is easy for you to identify. <b>Value Range: 1 ~ 32 characters.</b>
<b>Interface</b>	1. A Must fill setting 2. <b>WAN1</b> is selected by default	Define the selected interface to be the used for this PPTP tunnel ( <b>WAN-1</b> is available only when WAN-1 interface is enabled) The same applies to other WAN interfaces (e.g. <b>WAN-2</b> ).
<b>Remote IP/FQDN</b>	1. A Must fill setting. 2. Format can be a ipv4 address or FQDN	Enter the public IP address or the FQDN of the PPTP server.
<b>MTU</b>	1.A Must filled setting 2.The value is 1500 by default	Specify the <b>MTU</b> . <b>Value Range: 0 ~ 1500.</b>
<b>User Name</b>	A Must fill setting	Enter the <b>User Name</b> for this PPTP tunnel to be authenticated when connect to PPTP server. <b>Value Range: 1 ~ 32 characters.</b>
<b>Password</b>	A Must fill setting	Enter the <b>Password</b> for this PPTP tunnel to be authenticated when connect to PPTP server.
<b>Remote Subnet</b>	A Must fill setting	Specify the remote subnet for this PPTP tunnel to reach PPTP server. The Remote Subnet format must be IP address/netmask (e.g. 10.0.0.2/24). It is for the Intranet of PPTP VPN server. So, at PPTP client peer, the packets whose destination is in the dedicated subnet will be transferred via the PPTP

# 4G LTE M2M Router

		<p>VPN tunnel. Others will be transferred based on current routing policy of the security gateway at PPTP client peer.</p> <p>If you entered 0.0.0.0/0 in the Remote Subnet field, it will be treated as a default gateway setting for the PPTP client peer, all packets, including the Internet accessing of PPTP Client peer, will go through the established PPTP VPN tunnel. That means the remote PPTP VPN server controls the flow of any packets from the PPTP client peer. Certainly, those packets come through the PPTP VPN tunnel.</p>
<b>Authentication Protocol</b>	<ol style="list-style-type: none"> <li>1. A Must fill setting</li> <li>2. Unchecked by default</li> </ol>	<p>Specify one ore multiple <b>Authentication Protocol</b> for this PPTP tunnel. Available authentication methods are <b>PAP / CHAP / MS-CHAP / MS-CHAP v2</b>.</p>
<b>MPPE Encryption</b>	<ol style="list-style-type: none"> <li>1. Unchecked by default</li> <li>2. an optional setting</li> </ol>	<p>Specify whether PPTP server supports <b>MPPE Protocol</b>. Click the <b>Enable</b> box to enable MPPE.</p> <p>Note: when MPPE Encryption is enabled, the Authentication Protocol <b>PAP / CHAP</b> options will not be available.</p>
<b>NAT before Tunneling</b>	<ol style="list-style-type: none"> <li>1. A Must filled setting</li> <li>2. Unchecked by default</li> </ol>	<p>Specify whether NAT is required or not for this PPTP tunnel.</p>
<b>LCP Echo Type</b>	<p>Auto is set by default</p>	<p>Specify the LCP Echo Type for this PPTP tunnel. It can be <b>Auto</b>, <b>User-defined</b>, or <b>Disable</b>.</p> <p><b>Auto</b>: the system sets the Interval and Max. Failure Time.</p> <p><b>User-defined</b>: enter the Interval and Max. Failure Time. The default value for Interval is 30 seconds, and Maximum Failure Times is 6 Times.</p> <p><b>Disable</b>: disable the LCP Echo.</p> <p><b>Value Range</b>: 1 ~ 99999 for Interval Time, 1~999 for Failure Time.</p>
<b>Tunnel</b>	<p>Unchecked by default</p>	<p>Check the <b>Enable</b> box to enable this PPTP tunnel.</p>
<b>Save</b>	<p>N/A</p>	<p>Click <b>Save</b> button to save the settings.</p>
<b>Undo</b>	<p>N/A</p>	<p>Click <b>X</b> button to cancel the settings and back to last page.</p>

# 4G LTE M2M Router

## 5.1.5 GRE

Generic Routing Encapsulation (GRE) is a tunneling protocol developed by Cisco Systems that encapsulates a wide variety of network layer protocols inside virtual point-to-point links over an Internet Protocol internetwork.

Deploy a M2M gateway for remote site and establish a virtual private network with control center by using GRE tunneling. So, all client hosts behind M2M gateway can make data communication with server hosts behind control center gateway.

GRE Tunneling is similar to IPsec Tunneling, client requesting the tunnel establishment with the server. Both the client and the server must have a Static IP or a FQDN. Any peer gateway can be worked as either a client or a server, even using the same set of configuration rule.

### GRE Tunnel Scenario

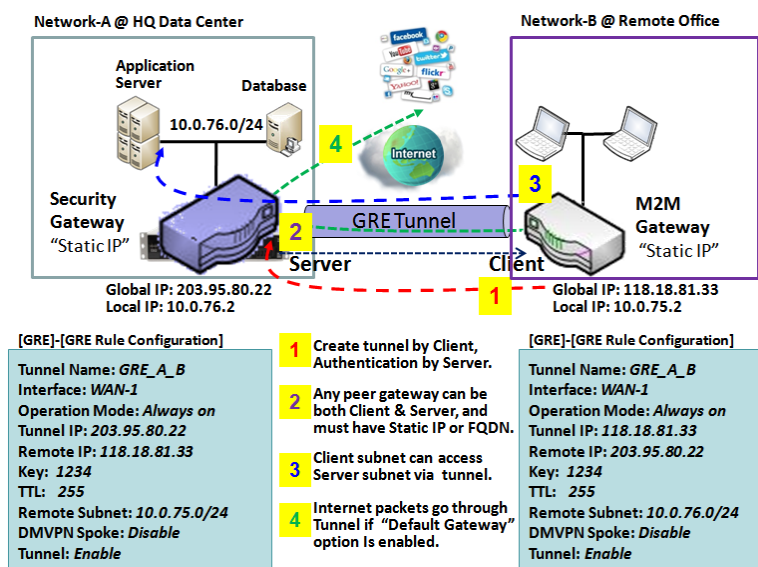

To setup a GRE tunnel, each peer needs to setup its global IP as tunnel IP and fill in the other's global IP as remote IP.

Besides, each peer must further specify the Remote Subnet item. It is for the Intranet of GRE server peer. So, at GRE client peer, the packets whose destination is in the dedicated subnet will be transferred via the GRE tunnel. Others will be transferred based on current routing policy of the gateway at GRE client peer. But, if you entered 0.0.0.0/0 in the Remote Subnet field, it will be treated as a "Default Gateway" setting for the GRE client peer, all packets, including the Internet accessing of GRE client peer, will go through the established GRE

tunnel. That means the remote GRE server peer controls the flow of any packets from the GRE client peer. Certainly, those packets come through the GRE tunnel.

If the GRE server supports DMVPN Hub function, like Cisco router as the VPN concentrator, the GRE client can active the DMVPN spoke function here since it is implemented by GRE over IPsec tunneling.

# 4G LTE M2M Router

## GRE Setting

Go to **Security > VPN > GRE** tab.

The GRE setting allows user to create and configure GRE tunnels.

### Enable GRE

Configuration	
Item	Setting
GRE Tunnel	<input type="checkbox"/> Enable
Max. Concurrent GRE Tunnels	32

Enable GRE Window		
Item	Value setting	Description
<b>GRE Tunnel</b>	Unchecked by default	Click the <b>Enable</b> box to enable GRE function.
<b>Max. Concurrent GRE Tunnels</b>	Depends on Product specification.	The specified value will limit the maximum number of simultaneous GRE tunnel connection. The default value can be different for the purchased model.
<b>Save</b>	N/A	Click <b>Save</b> button to save the settings
<b>Undo</b>	N/A	Click <b>Undo</b> button to cancel the settings

### Create/Edit GRE tunnel

GRE Tunnel List										
ID	Tunnel Name	Interface	Tunnel IP	Remote IP	MTU	Key	TTL	Remote Subnet	Enable	Actions

When **Add/Edit** button is applied, a GRE Rule Configuration screen will appear.

# 4G LTE M2M Router

GRE Rule Configuration	
Item	Setting
▶ Tunnel Name	<input type="text" value="GRE #1"/>
▶ Interface	<input type="text" value="WAN1"/>
▶ Tunnel IP	IP: <input type="text"/> MASK: <input type="text" value="-- select one --"/> (Optional)
▶ Remote IP	<input type="text"/>
▶ MTU	<input type="text"/>
▶ Key	<input type="text"/> (Optional)
▶ TTL	<input type="text"/>
▶ Remote Subnet	<input type="text"/>
▶ Tunnel	<input type="checkbox"/> Enable

GRE Rule Configuration Window		
Item	Value setting	Description
<b>Tunnel Name</b>	A Must fill setting	Enter a tunnel name. Enter a name that is easy for you to identify. <b>Value Range:</b> 1 ~ 9 characters.
<b>Interface</b>	1. A Must fill setting 2. <b>WAN 1</b> is selected by default	Select the interface on which GRE tunnel is to be established. It can be the available WAN and LAN interfaces.
<b>Tunnel IP</b>	An Optional setting	Enter the Tunnel IP address and corresponding subnet mask.
<b>Remote IP</b>	A Must fill setting	Enter the Remote IP address of remote GRE tunnel gateway. Normally this is the public IP address of the remote GRE gateway.
<b>MTU</b>	1. A Must filled setting 2. <b>Auto</b> (value zero or blank) is set by default	<b>MTU</b> refers to Maximum Transmission Unit. It specifies the largest packet size permitted for Internet transmission. When set to <b>Auto</b> (value '0' or blank), the router selects the best MTU for best Internet connection performance. <b>Value Range:</b> 0 ~ 1500.
<b>Key</b>	An Optional setting	Enter the Key for the GRE connection. <b>Value Range:</b> 0 ~ 9999999999.
<b>TTL</b>	1. A Must fill setting 2. 1 to 255 range	Specify <b>TTL</b> hop-count value for this GRE tunnel. <b>Value Range:</b> 1 ~ 255.
<b>Remote Subnet</b>	A Must fill setting	Specify the remote subnet for this GRE tunnel. The Remote Subnet format must be IP address/netmask (e.g. 10.0.0.2/24). It is for the Intranet of GRE server peer. So, at GRE client peer, the packets whose destination is in the dedicated subnet will be transferred via the GRE tunnel. Others will be transferred based on current routing policy of the security gateway at GRE client peer.  If you entered 0.0.0.0/0 in the Remote Subnet field, it will be treated as a default gateway setting for the GRE client peer, all packets, including the

# 4G LTE M2M Router

		Internet accessing of GRE client peer, will go through the established GRE tunnel. That means the remote GRE server peer controls the flow of any packets from the GRE client peer. Certainly, those packets come through the GRE tunnel.
<b>Tunnel</b>	Unchecked by default	Check <b>Enable</b> box to enable this GRE tunnel.
<b>Save</b>	N/A	Click <b>Save</b> button to save the settings.
<b>Undo</b>	N/A	Click <b>X</b> button to cancel the settings and back to last page.

# 4G LTE M2M Router

## 5.2 Firewall

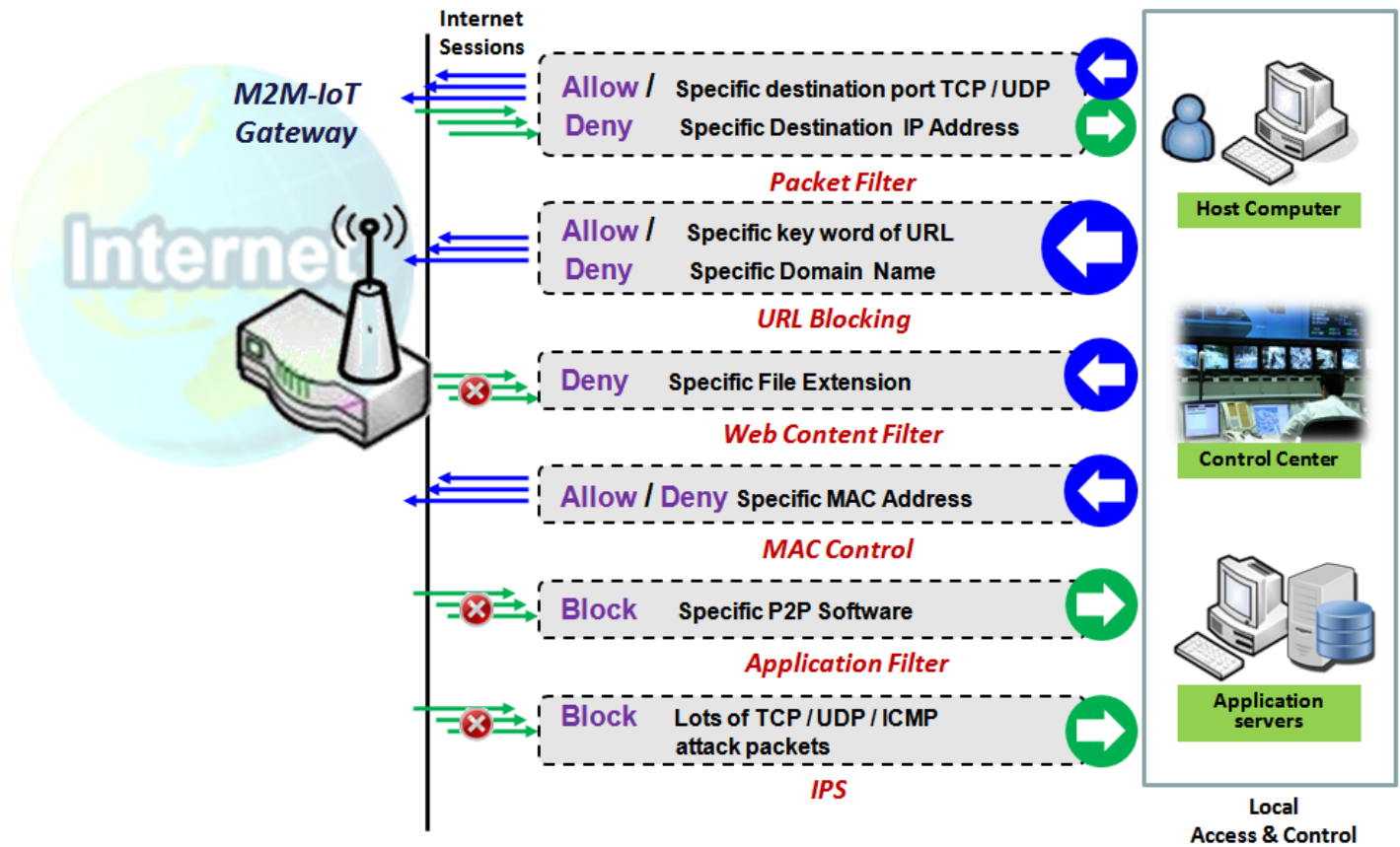

The firewall functions include Packet Filter, URL Blocking, Content Filter, MAC Control, Application Filter, IPS and some firewall options. The supported function can be different for the purchased gateway.

### 5.2.1 Packet Filter

Configuration												
Item	Setting											
▶ Packet Filters	<input checked="" type="checkbox"/> Enable											
▶ Black List / White List	Deny those match the following rules. ▼											
▶ Log Alert	<input type="checkbox"/> Log Alert											
Packet Filter List												
Add Delete												
ID	Rule Name	From Interface	To Interface	Source IP	Destination IP	Source MAC	Protocol	Source Port	Destination Port	Time Schedule	Enable	Actions

# 4G LTE M2M Router

"Packet Filter" function can let you define some filtering rules for incoming and outgoing packets. So the gateway can control what packets are allowed or blocked to pass through it. A packet filter rule should indicate from and to which interface the packet enters and leaves the gateway, the source and destination IP addresses, and destination service port type and port number. In addition, the time schedule to which the rule will be active.

## Packet Filter with White List Scenario

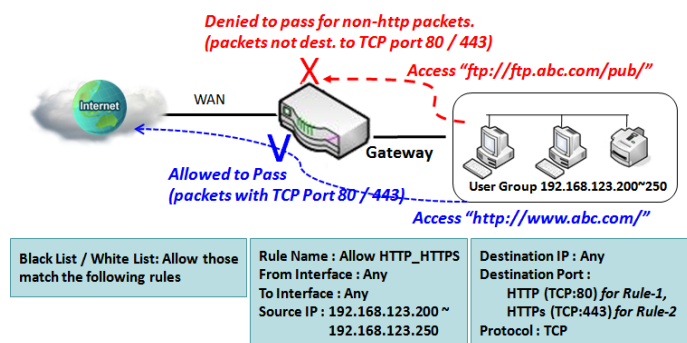

As shown in the diagram, specify "Packet Filter Rule List" as white list (Allow those match the following rules) and define the rules. Rule-1 is to allow HTTP packets to pass, and Rule-2 is to allow HTTPS packets to pass.

Under such configuration, the gateway will allow only HTTP and HTTPS packets, issued from the IP range 192.168.123.200 to 250, which are targeted to TCP port 80 or 443 to pass the WAN interface.

## Packet Filter Setting

Go to **Security > Firewall > Packet Filter** Tab.

The packet filter setting allows user to create and customize packet filter policies to allow or reject specific inbound/outbound packets through the router based on their office setting.

## Enable Packet Filter

Item	Setting
▶ Packet Filters	<input type="checkbox"/> Enable
▶ Black List / White List	Deny those match the following rules. ▼
▶ Log Alert	<input type="checkbox"/> Log Alert

Item Name	Value setting	Description
<b>Packet Filter</b>	The box is unchecked by default	Check the <b>Enable</b> box to activate Packet Filter function

# 4G LTE M2M Router

<b>Black List / White List</b>	Deny those match the following rules is set by default	When <b>Deny those match the following rules</b> is selected, as the name suggest, packets specified in the rules will be blocked –black listed. In contrast, with <b>Allow those match the following rules</b> , you can specifically white list the packets to pass and the rest will be blocked.
<b>Log Alert</b>	The box is unchecked by default	Check the <b>Enable</b> box to activate Event Log.
<b>Save</b>	N/A	Click <b>Save</b> to save the settings
<b>Undo</b>	N/A	Click <b>Undo</b> to cancel the settings

## Create/Edit Packet Filter Rules

The gateway allows you to customize your packet filtering rules. It supports up to a maximum of 20 filter rule sets.

ID	Rule Name	From Interface	To Interface	Source IP	Destination IP	Source MAC	Protocol	Source Port	Destination Port	Time Schedule	Enable	Actions
----	-----------	----------------	--------------	-----------	----------------	------------	----------	-------------	------------------	---------------	--------	---------

When **Add** button is applied, **Packet Filter Rule Configuration** screen will appear.

Packet Filter Rule Configuration	
Item	Setting
▶ Rule Name	Rule1
▶ From Interface	Any ▼
▶ To Interface	Any ▼
▶ Source IP	Any ▼
▶ Destination IP	Any ▼
▶ Source MAC	Any ▼
▶ Protocol	Any(0) ▼
▶ Source Port	User-defined Service ▼ [ ] - [ ]
▶ Destination Port	User-defined Service ▼ [ ] - [ ]
▶ Time Schedule	{0} Always ▼
▶ Rule	<input type="checkbox"/> Enable

Packet Filter Rule Configuration		
Item Name	Value setting	Description
<b>Rule Name</b>	1. String format can be any text 2. A Must filled setting	Enter a packet filter rule name. Enter a name that is easy for you to remember. <b>Value Range: 1 ~ 30 characters.</b>
<b>From Interface</b>	1. A Must filled setting	Define the selected interface to be the packet-entering interface of the router.

# 4G LTE M2M Router

	<p><b>2. By default Any is selected</b></p> <p>If the packets to be filtered are coming from <b>LAN to WAN</b> then select LAN for this field. Or <b>VLAN-1 to WAN</b> then select <b>VLAN-1</b> for this field. Other examples are VLAN-1 to VLAN-2. VLAN-1 to WAN.</p> <p>Select <b>Any</b> to filter packets coming into the router from any interfaces. Please note that two identical interfaces are not accepted by the router. e.g., VLAN-1 to VLAN-1.</p>
<p><b>To Interface</b></p> <p>1. A Must filled setting 2. By default Any is selected</p>	<p>Define the selected interface to be the packet-leaving interface of the router. If the packets to be filtered are entering from <b>LAN to WAN</b> then select <b>WAN</b> for this field. Or <b>VLAN-1 to WAN</b> then select <b>WAN</b> for this field. Other examples are VLAN-1 to VLAN-2. VLAN-1 to WAN.</p> <p>Select <b>Any</b> to filter packets leaving the router from any interfaces. Please note that two identical interfaces are not accepted by the router. e.g., VLAN-1 to VLAN-1.</p>
<p><b>Source IP</b></p> <p>1. A Must filled setting 2. By default Any is selected</p>	<p>This field is to specify the <b>Source IP address</b>.</p> <p>Select <b>Any</b> to filter packets coming from any IP addresses.</p> <p>Select <b>Specific IP Address</b> to filter packets coming from an IP address.</p> <p>Select <b>IP Range</b> to filter packets coming from a specified range of IP address.</p> <p>Select <b>IP Address-based Group</b> to filter packets coming from a pre-defined group. Note: group must be pre-defined before this option become available. Refer to <b>Object Definition &gt; Grouping &gt; Host grouping</b>. You may also access to create a group by the <b>Add Rule</b> shortcut button.</p>
<p><b>Destination IP</b></p> <p>1. A Must filled setting 2. By default Any is selected</p>	<p>This field is to specify the <b>Destination IP address</b>.</p> <p>Select <b>Any</b> to filter packets that are entering to any IP addresses.</p> <p>Select <b>Specific IP Address</b> to filter packets entering to an IP address entered in this field.</p> <p>Select <b>IP Range</b> to filter packets entering to a specified range of IP address entered in this field.</p> <p>Select <b>IP Address-based Group</b> to filter packets entering to a pre-defined group selected. Note: group must be pre-defined before this selection become available. Refer to <b>Object Definition &gt; Grouping &gt; Host grouping</b>. You may also access to create a group by the <b>Add Rule</b> shortcut button. Setting done through the <b>Add Rule</b> button will also appear in the <b>Host grouping</b> setting screen.</p>
<p><b>Source MAC</b></p> <p>1. A Must filled setting 2. By default Any is selected</p>	<p>This field is to specify the <b>Source MAC address</b>.</p> <p>Select <b>Any</b> to filter packets coming from any MAC addresses.</p> <p>Select <b>Specific MAC Address</b> to filter packets coming from a MAC address.</p> <p>Select <b>MAC Address-based Group</b> to filter packets coming from a pre-defined group selected. Note: group must be pre-defined before this selection become available. Refer to <b>Object Definition &gt; Grouping &gt; Host grouping</b>. You may also access to create a group by the <b>Add Rule</b> shortcut button.</p>
<p><b>Protocol</b></p> <p>1. A Must filled setting 2. By default Any(0) is selected</p>	<p>For <b>Protocol</b>, select <b>Any</b> to filter any protocol packets</p> <p>Then for <b>Source Port</b>, select a predefined port dropdown box when <b>Well-known Service</b> is selected, otherwise select <b>User-defined Service</b> and specify a port range.</p> <p>Then for <b>Destination Port</b>, select a predefined port dropdown box when <b>Well-known Service</b> is selected, otherwise select <b>User-defined Service</b> and specify a port range.</p>

# 4G LTE M2M Router

		<p><b><i>Value Range:</i></b> 1 ~ 65535 for Source Port, Destination Port.</p> <p>For <b>Protocol</b>, select <b>ICMPv4</b> to filter ICMPv4 packets</p> <p>For <b>Protocol</b>, select <b>TCP</b> to filter <b>TCP</b> packets</p> <p>Then for <b>Source Port</b>, select a predefined port dropdown box when <b>Well-known Service</b> is selected, otherwise select <b>User-defined Service</b> and specify a port range.</p> <p>Then for <b>Destination Port</b>, select a predefined port dropdown box when <b>Well-known Service</b> is selected, otherwise select <b>User-defined Service</b> and specify a port range.</p> <p><b><i>Value Range:</i></b> 1 ~ 65535 for Source Port, Destination Port.</p> <p>For <b>Protocol</b>, select <b>UDP</b> to filter <b>UDP</b> packets</p> <p>Then for <b>Source Port</b>, select a predefined port dropdown box when <b>Well-known Service</b> is selected, otherwise select <b>User-defined Service</b> and specify a port range.</p> <p>Then for <b>Destination Port</b>, select a predefined port dropdown box when <b>Well-known Service</b> is selected, otherwise select <b>User-defined Service</b> and specify a port range.</p> <p><b><i>Value Range:</i></b> 1 ~ 65535 for Source Port, Destination Port.</p> <p>For <b>Protocol</b>, select <b>GRE</b> to filter <b>GRE</b> packets</p> <p>For <b>Protocol</b>, select <b>ESP</b> to filter <b>ESP</b> packets</p> <p>For <b>Protocol</b>, select <b>SCTP</b> to filter <b>SCTP</b> packets</p> <p>For <b>Protocol</b>, select <b>User-defined</b> to filter packets with specified port number. Then enter a port number in <b>Protocol Number</b> box.</p>
<b>Time Schedule</b>	A Must filled setting	<p>Apply <b>Time Schedule</b> to this rule, otherwise leave it as Always.</p> <p>If the dropdown list is empty ensure <b>Time Schedule</b> is pre-configured. Refer to <b>Object Definition &gt; Scheduling &gt; Configuration</b> tab.</p>
<b>Rule</b>	The box is unchecked by default.	Click <b>Enable</b> box to activate this rule then save the settings.
<b>Save</b>	N/A	Click <b>Save</b> to save the settings
<b>Undo</b>	N/A	Click <b>Undo</b> to cancel the settings
<b>Back</b>	N/A	When the <b>Back</b> button is clicked the screen will return to the Packet Filter Configuration page.

# 4G LTE M2M Router

## 5.2.2 URL Blocking

"URL Blocking" function can let you define blocking or allowing rules for incoming and outgoing Web request packets. With defined rules, gateway can control the Web requests containing the complete URL, partial domain name, or pre-defined keywords. For example, one can filter out or allow only the Web requests based on domain input suffixes like .com or .org or keywords like "bct" or "mpe".

An URL blocking rule should specify the URL, partial domain name, or included keywords in the Web requests from and to the gateway and also the destination service port. Besides, a certain time schedule can be applied to activate the URL Blocking rules during pre-defined time interval(s).

The gateway will logs and displays the disallowed web accessing requests that matched the defined URL blocking rule in the black-list or in the exclusion of the white-list.

When you choose "Allow all to pass except those match the following rules" for the "URL Blocking Rule List", you are setting the defined URL blocking rules to belong to the black list. The packets, listed in the rule list, will be blocked if one pattern in the requests matches to one rule. Other Web requests can pass through the gateway. In contrast, when you choose "Deny all to pass except those match the following rules" for the "URL Blocking Rule List", you are setting the defined packet filtering rules to belong to the white list. The Web requests, listed in the rule, will be allowed if one pattern in the requests matches to one rule. Other Web requests will be blocked.

### URL Blocking Rule with Black List

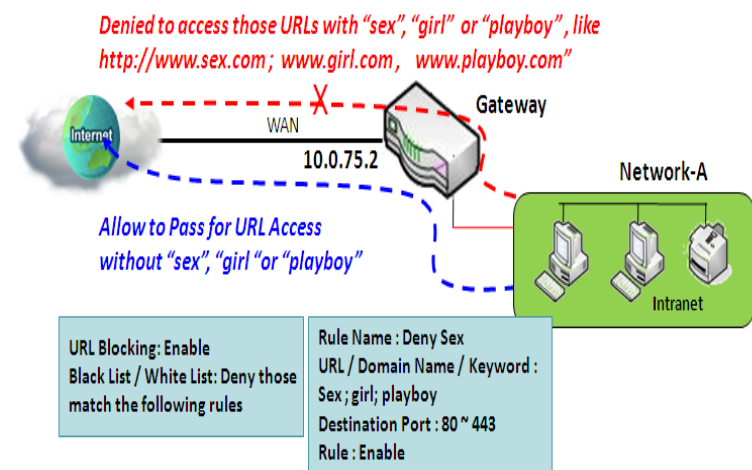

When the administrator of the gateway wants to block the Web requests with some dedicated patterns, he can use the "URL Blocking" function to block specific Web requests by defining the black list as shown in above diagram. Certainly, when the administrator wants to allow only the Web requests with some dedicated patterns to go through the gateway, he can also use the "URL Blocking" function by defining the white list to meet the requirement.

As shown in the diagram, enable the URL blocking function and create the first rule to deny the Web requests with "sex" or "sexygirl" patterns and the other to deny the Web requests with "playboy" pattern to go through the gateway. System will block the Web requests with "sex", "sexygirl" or "playboy" patterns to pass through the gateway.

# 4G LTE M2M Router

## URL Blocking Setting

Go to **Security > Firewall > URL Blocking** Tab.

In "URL Blocking" page, there are three configuration windows. They are the "Configuration" window, "URL Blocking Rule List" window, and "URL Blocking Rule Configuration" window.

The "Configuration" window can let you activate the URL blocking function and specify to black listing or to white listing the packets defined in the "URL Blocking Rule List" entry. In addition, log alerting can be enabled to record on-going events for any disallowed Web request packets. Refer to "System Status" in "6.1.1 System Related" section in this user manual for how to view recorded log.

The "URL Blocking Rule List" window lists all your defined URL blocking rule entry. And finally, the "URL Blocking Rule Configuration" window can let you define URL blocking rules. The parameters in a rule include the rule name, the Source IP or MAC, the URL/Domain Name/Keyword, the destination service ports, the integrated time schedule rule and the rule activation.

### Enable URL Blocking

Configuration	
Item	Setting
▶ URL Blocking	<input checked="" type="checkbox"/> Enable
▶ Black List / White List	Deny those match the following rules. ▼
▶ Log Alert	<input type="checkbox"/> Enable

Configuration Item	Value setting	Description
<b>URL Blocking</b>	The box is unchecked by default	Check the <b>Enable</b> box to activate URL Blocking function.
<b>Black List / White List</b>	<b>Deny those match the following rules</b> is set by default	Specify the URL Blocking Policy, either Black List or White List. Black List: When <b>Deny those match the following rules</b> is selected, as the name suggest, the matched Web request packets will be blocked. White List: When <b>Allow those match the following rules</b> is selected, the matched Web request packets can pass through the Gateway, and the others that don't match the rules will be blocked.
<b>Log Alert</b>	The box is unchecked by default	Check the <b>Enable</b> box to activate Event Log.
<b>Save</b>	NA	Click <b>Save</b> button to save the settings
<b>Undo</b>	NA	Click <b>Undo</b> button to cancel the settings

### Create/Edit URL Blocking Rules

The Gateway supports up to a maximum of 20 URL blocking rule sets. Ensure that the URL Blocking is enabled before we can create blocking rules.

# 4G LTE M2M Router

ID	Rule Name	Source IP	Source MAC	URL / Domain Name / Keyword	Destination Port	Time Schedule	Enable	Actions
----	-----------	-----------	------------	-----------------------------	------------------	---------------	--------	---------

When **Add** button is applied, the **URL Blocking Rule Configuration** screen will appear.

**URL Blocking Rule Configuration**

Item	Setting
▶ Rule Name	<input type="text" value="Rule1"/>
▶ Source IP	<input type="text" value="Any"/>
▶ Source MAC	<input type="text" value="Any"/>
▶ URL / Domain Name / Keyword	<input type="text"/>
▶ Destination Port	<input type="text" value="Any"/>
▶ Time Schedule Rule	<input type="text" value="(0) Always"/>
▶ Rule	<input type="checkbox"/> Enable

URL Blocking Rules Configuration		
Item	Value setting	Description
<b>Rule Name</b>	<ol style="list-style-type: none"> <li>String format can be any text</li> <li>A Must filled setting</li> </ol>	Specify an URL Blocking rule name. Enter a name that is easy for you to understand.
<b>Source IP</b>	<ol style="list-style-type: none"> <li>A Must filled setting</li> <li><b>Any</b> is set by default</li> </ol>	This field is to specify the <b>Source IP address</b> . <ul style="list-style-type: none"> <li>Select <b>Any</b> to filter packets coming from any IP addresses.</li> <li>Select <b>Specific IP Address</b> to filter packets coming from an IP address entered in this field.</li> <li>Select <b>IP Range</b> to filter packets coming from a specified range of IP address entered in this field.</li> </ul>
<b>Source MAC</b>	<ol style="list-style-type: none"> <li>A Must filled setting</li> <li><b>Any</b> is set by default</li> </ol>	This field is to specify the <b>Source MAC address</b> . <ul style="list-style-type: none"> <li>Select <b>Any</b> to filter packets coming from any MAC addresses.</li> <li>Select <b>Specific MAC Address</b> to filter packets coming from a MAC address entered in this field.</li> </ul>
<b>URL / Domain Name / Keyword</b>	<ol style="list-style-type: none"> <li>A Must filled setting</li> <li>Supports up to a maximum of 10 Keywords in a rule by using the delimiter “;”.</li> </ol>	Specify URL, Domain Name, or Keyword list for URL checking. <ul style="list-style-type: none"> <li>In the <b>Black List</b> mode, if a matched rule is found, the packets will be dropped.</li> <li>In the <b>White List</b> mode, if a matched rule is found, the packets will be accepted and the others which don't match any rule will be dropped.</li> </ul>
<b>Destination Port</b>	<ol style="list-style-type: none"> <li>A Must filled setting</li> <li><b>Any</b> is set by default</li> </ol>	This field is to specify the <b>Destination Port number</b> . <ul style="list-style-type: none"> <li>Select <b>Any</b> to filter packets going to any Port.</li> <li>Select <b>Specific Service Port</b> to filter packets going to a specific Port entered in this field.</li> <li>Select <b>Port Range</b> to filter packets going to a specific range of Ports entered in this field.</li> </ul>
<b>Time Schedule Rule</b>	A Must filled setting	Apply a specific <b>Time Schedule</b> to this rule; otherwise leave it as <b>(0) Always</b> . If the dropdown list is empty ensure <b>Time Schedule</b> is pre-configured. Refer to <b>Object Definition &gt; Scheduling &gt; Configuration</b> tab.
<b>Rule</b>	The box is unchecked by default.	Click the <b>Enable</b> box to activate this rule.
<b>Save</b>	NA	Click the <b>Save</b> button to save the settings.
<b>Undo</b>	NA	Click the <b>Undo</b> button to cancel the changes.
<b>Back</b>	NA	Click the <b>Back</b> button to return to the URL Blocking Configuration page.

# 4G LTE M2M Router

## 5.2.3 MAC Control

Configuration

Item	Setting
MAC Control	<input checked="" type="checkbox"/> Enable
Black List / White List	Deny MAC Address Below. ▼
Log Alert	<input type="checkbox"/> Enable
Known MAC from LAN PC List	▼ Copy to

MAC Control Rule List Add Delete

ID	Rule Name	MAC Address	Time Schedule Rule	Enable	Actions
----	-----------	-------------	--------------------	--------	---------

"MAC Control" function allows you to assign the accessibility to the gateway for different users based on device's MAC address. When the administrator wants to reject the traffics from some client hosts with specific MAC addresses, he can use the "MAC Control" function to reject with the black list configuration.

### MAC Control with Black List Scenario

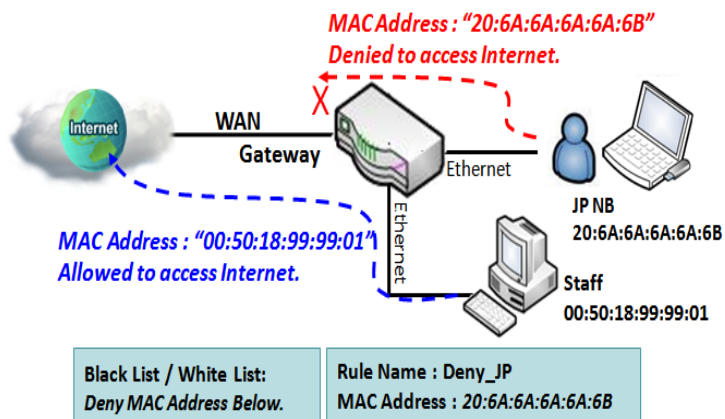

As shown in the diagram, enable the MAC control function and specify the "MAC Control Rule List" is a black list, and configure one MAC control rule for the gateway to deny the connection request from the "JP NB" with its own MAC address 20:6A:6A:6A:6A:6B.

System will block the connecting from the "JP NB" to the gateway but allow others.

# 4G LTE M2M Router

## MAC Control Setting

Go to **Security > Firewall > MAC Control** Tab.

The MAC control setting allows user to create and customize MAC address policies to allow or reject packets with specific source MAC address.

### Enable MAC Control

Configuration	
Item	Setting
▶ MAC Control	<input type="checkbox"/> Enable
▶ Black List / White List	Deny MAC Address Below. ▼
▶ Log Alert	<input type="checkbox"/> Enable
▶ Known MAC from LAN PC List	▼ <input type="button" value="Copy to"/>

Configuration Window		
Item	Value setting	Description
<b>MAC Control</b>	The box is unchecked by default	Check the <b>Enable</b> box to activate the MAC filter function
<b>Black List / White List</b>	Deny MAC Address Below is set by default	When <b>Deny MAC Address Below</b> is selected, as the name suggest, packets specified in the rules will be blocked –black listed. In contrast, with <b>Allow MAC Address Below</b> , you can specifically white list the packets to pass and the rest will be blocked.
<b>Log Alert</b>	The box is unchecked by default	Check the <b>Enable</b> box to activate to activate Event Log.
<b>Known MAC from LAN PC List</b>	N/A	Select a MAC Address from LAN Client List. Click the <b>Copy to</b> to copy the selected <b>MAC Address</b> to the filter rule.
<b>Save</b>	N/A	Click <b>Save</b> to save the settings
<b>Undo</b>	N/A	Click <b>Undo</b> to cancel the settings

# 4G LTE M2M Router

## Create/Edit MAC Control Rules

The gateway supports up to a maximum of 20 filter rule sets. Ensure that the MAC Control is enabled before we can create control rules.

MAC Control Rule List					
ID	Rule Name	MAC Address	Time Schedule Rule	Enable	Actions

When **Add** button is applied, **Filter Rule Configuration** screen will appear.

MAC Control Rule Configuration			
Rule Name	MAC Address (Use : to Compose)	Time Schedule	Enable
<input type="text" value="Rule1"/>	<input type="text"/>	(0) Always ▾	<input type="checkbox"/>
<input type="button" value="Save"/>			

MAC Control Rule Configuration		
Item	Value setting	Description
<b>Rule Name</b>	1. String format can be any text 2. A Must fill setting	Enter a MAC Control rule name. Enter a name that is easy for you to remember.
<b>MAC Address (Use: to Compose)</b>	1. MAC Address string Format 2. A Must fill setting	Specify the <b>Source MAC Address</b> to filter rule.
<b>Time Schedule</b>	A Must fill setting	Apply <b>Time Schedule</b> to this rule; otherwise leave it as <b>(0) Always</b> . If the dropdown list is empty, ensure <b>Time Schedule</b> is pre-configured. Refer to <b>Object Definition &gt; Scheduling &gt; Configuration tab</b>
<b>Enable</b>	The box is unchecked by default.	Click <b>Enable</b> box to activate this rule, and then save the settings.
<b>Save</b>	N/A	Click <b>Save</b> to save the settings
<b>Undo</b>	N/A	Click <b>Undo</b> to cancel the settings

# 4G LTE M2M Router

## 5.2.4 Content Filter (not supported)

Not supported feature for the purchased product, leave it as blank.

# 4G LTE M2M Router

## 5.2.5 Application Filter (not supported)

Not supported feature for the purchased product, leave it as blank.

# 4G LTE M2M Router

## 5.2.6 IPS

Configuration	
Item	Setting
▶ IPS	<input type="checkbox"/> Enable
▶ Log Alert	<input type="checkbox"/> Enable

  

Intrusion Prevention	
Item	Setting
▶ SYN Flood Defense	<input type="checkbox"/> Enable <input type="text" value="300"/> Packets/second (10~10000)
▶ UDP Flood Defense	<input type="checkbox"/> Enable <input type="text" value="300"/> Packets/second (10~10000)
▶ ICMP Flood Defense	<input type="checkbox"/> Enable <input type="text" value="300"/> Packets/second (10~10000)
▶ Port Scan Defense	<input type="checkbox"/> Enable <input type="text" value="200"/> Packets/second (10~10000)

To provide application servers in the Internet, administrator may need to open specific ports for the services. However, there are some risks to always open service ports in the Internet. In order to avoid such attack risks, it is important to enable IPS functions.

Intrusion Prevention System (IPS) is network security appliances that monitor network and/or system activities for malicious activity. The main functions of IPS are to identify malicious activity, log information about this activity, attempt to block/stop it and report it. You can enable the IPS function and check the listed intrusion activities when needed. You can also enable the log alerting so that system will record Intrusion events when corresponding intrusions are detected.

### IPS Scenario

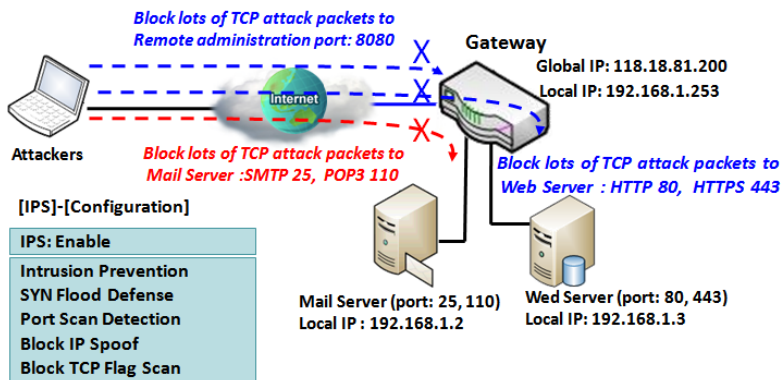

As shown in the diagram, the gateway serves as an E-mail server, Web Server and also provides TCP port 8080 for remote administration. So, remote users or unknown users can request those services from Internet. With IPS enabled, the gateway can detect incoming attack packets, including the TCP ports (25, 80, 110, 443 and 8080) with services. It will block the attack packets and let the normal access to pass through the gateway

# 4G LTE M2M Router

## IPS Setting

---

Go to **Security > Firewall > IPS** Tab.

The Intrusion Prevention System (IPS) setting allows user to customize intrusion prevention rules to prevent malicious packets.

### Enable IPS Firewall

Configuration	
Item	Setting
▶ IPS	<input type="checkbox"/> Enable
▶ Log Alert	<input type="checkbox"/> Enable

Configuration Window		
Item	Value setting	Description
<b>IPS</b>	The box is unchecked by default	Check the <b>Enable</b> box to activate IPS function
<b>Log Alert</b>	The box is unchecked by default	Check the <b>Enable</b> box to activate to activate Event Log.
<b>Save</b>	N/A	Click <b>Save</b> to save the settings
<b>Undo</b>	N/A	Click <b>Undo</b> to cancel the settings

### Setup Intrusion Prevention Rules

The router allows you to select intrusion prevention rules you may want to enable. Ensure that the IPS is enabled before we can enable the defense function.

# 4G LTE M2M Router

Intrusion Prevention	
Item	Setting
▶ SYN Flood Defense	<input type="checkbox"/> Enable <input type="text" value="300"/> Packets/second (10~10000)
▶ UDP Flood Defense	<input type="checkbox"/> Enable <input type="text" value="300"/> Packets/second (10~10000)
▶ ICMP Flood Defense	<input type="checkbox"/> Enable <input type="text" value="300"/> Packets/second (10~10000)
▶ Port Scan Defense	<input type="checkbox"/> Enable <input type="text" value="200"/> Packets/second (10~10000)
▶ Block Land Attack	<input type="checkbox"/> Enable
▶ Block Ping of Death	<input type="checkbox"/> Enable
▶ Block IP Spoof	<input type="checkbox"/> Enable
▶ Block TCP Flag Scan	<input type="checkbox"/> Enable
▶ Block Smurf	<input type="checkbox"/> Enable
▶ Block Traceroute	<input type="checkbox"/> Enable
▶ Block Fraggle Attack	<input type="checkbox"/> Enable
▶ ARP Spoofing Defense	<input type="checkbox"/> Enable <input type="text" value="300"/> Packets/second (10~10000)

Setup Intrusion Prevention Rules		
Item Name	Value setting	Description
<b>SYN Flood Defense</b>	1. A Must filled setting	Click <b>Enable</b> box to activate this intrusion prevention rule and enter the traffic threshold in this field.
<b>UDP Flood Defense</b>	2. The box is unchecked by default.	Click <b>Enable</b> box to activate this intrusion prevention rule and enter the traffic threshold in this field.
<b>ICMP Flood Defense</b>	3. Traffic threshold is set to 300 by default 4. The value range can be from 10 to 10000.	Click <b>Enable</b> box to activate this intrusion prevention rule and enter the traffic threshold in this field. <b>Value Range: 10 ~ 10000.</b>
<b>Port Scan Defection</b>	1. A Must filled setting 2. The box is unchecked by default. 3. Traffic threshold is set to 200 by default 4. The value range can be from 10 to 10000.	Click <b>Enable</b> box to activate this intrusion prevention rule and enter the traffic threshold in this field. <b>Value Range: 10 ~ 10000.</b>
<b>Block Land Attack</b> <b>Block Ping of Death</b> <b>Block IP Spoof</b> <b>Block TCP Flag Scan</b> <b>Block Smurf</b> <b>Block Traceroute</b> <b>Block Fraggle</b>	The box is unchecked by default.	Click <b>Enable</b> box to activate this intrusion prevention rule.

# 4G LTE M2M Router

Attack		
<b>ARP Spoofing Defence</b>	<ol style="list-style-type: none"><li>1. A Must filled setting</li><li>2. The box is unchecked by default.</li><li>3. Traffic threshold is set to 300 by default</li><li>4. The value range can be from 10 to 10000.</li></ol>	Click <b>Enable</b> box to activate this intrusion prevention rule and enter the traffic threshold in this field. <b><u>Value Range: 10 ~ 10000.</u></b>
<b>Save</b>	NA	Click <b>Save</b> to save the settings
<b>Undo</b>	NA	Click <b>Undo</b> to cancel the settings

# 4G LTE M2M Router

## 5.2.7 Options

Firewall Options							
Item		Setting					
▶ Stealth Mode		<input type="checkbox"/> Enable					
▶ SPI		<input type="checkbox"/> Enable					
▶ Discard Ping from WAN		<input type="checkbox"/> Enable					

Remote Administrator Host Definition							
ID	Interface	Protocol	IP	Subnet Mask	Service Port	Enable	Action
1	All WAN	HTTP	Any IP	N/A	80	<input checked="" type="checkbox"/>	Edit
2	All WAN	HTTPS	Any IP	N/A	443	<input checked="" type="checkbox"/>	Edit
3	All WAN	HTTP	Any IP	N/A	80	<input type="checkbox"/>	Edit
4	All WAN	HTTP	Any IP	N/A	80	<input type="checkbox"/>	Edit
5	All WAN	HTTP	Any IP	N/A	80	<input type="checkbox"/>	Edit

There are some additional useful firewall options in this page.

“Stealth Mode” lets gateway not to respond to port scans from the WAN so that makes it less susceptible to discovery and attacks on the Internet. “SPI” enables gateway to record the packet information like IP address, port address, ACK, SEQ number and so on while they pass through the gateway, and the gateway checks every incoming packet to detect if this packet is valid.

“Discard Ping from WAN” makes any host on the WAN side can't ping this gateway. And finally, “Remote Administrator Hosts” enables you to perform administration task from a remote host. If this feature is enabled, only specified IP address(es) can perform remote administration.

# 4G LTE M2M Router

## Enable SPI Scenario

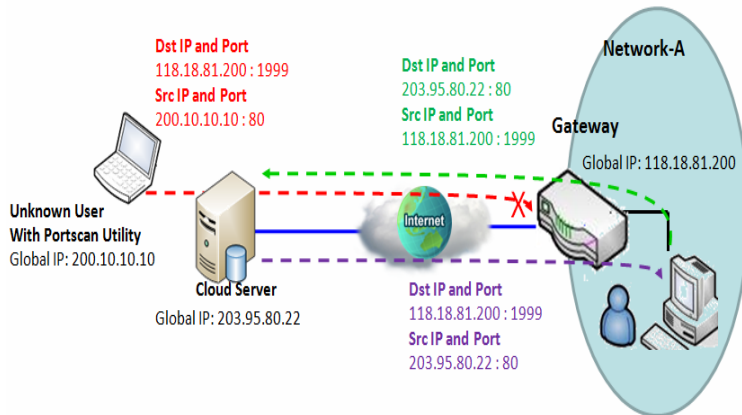

As shown in the diagram, Gateway has the IP address of 118.18.81.200 for WAN interface and 192.168.1.253 for LAN interface. It serves as a NAT gateway. Users in Network-A initiate to access cloud server through the gateway. Sometimes, unknown users will simulate the packets but use different source IP to masquerade. With the SPI feature been enabled at the gateway, it will block such packets from unknown users.

## Discard Ping from WAN & Remote Administrator Hosts Scenario

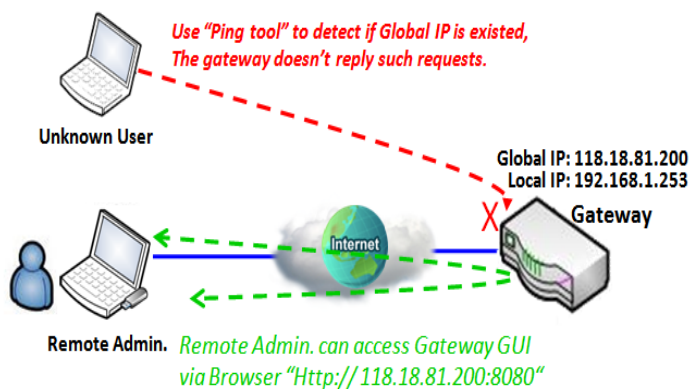

"Discard Ping from WAN" makes any host on the WAN side can't ping this gateway reply any ICMP packets. Enable the Discard Ping from WAN function to prevent security leak when local users surf the internet.

Remote administrator knows the gateway's global IP, and he can access the Gateway GUI via TCP port 8080.

# 4G LTE M2M Router

## Firewall Options Setting

Go to **Security > Firewall > Options Tab**.

The firewall options setting allows network administrator to modify the behavior of the firewall and to enable Remote Router Access Control.

### Enable Firewall Options

Firewall Options	
Item	Setting
▶ Stealth Mode	<input type="checkbox"/> Enable
▶ SPI	<input checked="" type="checkbox"/> Enable
▶ Discard Ping from WAN	<input type="checkbox"/> Enable

Firewall Options		
Item	Value setting	Description
<b>Stealth Mode</b>	The box is unchecked by default	Check the <b>Enable</b> box to activate the Stealth Mode function
<b>SPI</b>	The box is checked by default	Check the <b>Enable</b> box to activate the SPI function
<b>Discard Ping from WAN</b>	The box is unchecked by default	Check the <b>Enable</b> box to activate the Discard Ping from WAN function

### Define Remote Administrator Host

The router allows network administrator to manage router remotely. The network administrator can assign specific IP address and service port to allow accessing the router.

# 4G LTE M2M Router

Remote Administrator Host Definition							
ID	Interface	Protocol	IP	Subnet Mask	Service Port	Enable	Action
1	All WAN	HTTP	Any IP	N/A	80	<input checked="" type="checkbox"/>	Edit
2	All WAN	HTTPS	Any IP	N/A	443	<input checked="" type="checkbox"/>	Edit
3	All WAN	HTTP	Any IP	N/A	80	<input type="checkbox"/>	Edit
4	All WAN	HTTP	Any IP	N/A	80	<input type="checkbox"/>	Edit
5	All WAN	HTTP	Any IP	N/A	80	<input type="checkbox"/>	Edit

Remote Administrator Host Definition		
Item	Value setting	Description
<b>Protocol</b>	HTTP is set by default	Select <b>HTTP</b> or <b>HTTPS</b> method for router access.
<b>IP</b>	A Must filled setting	This field is to specify the remote host to assign access right for remote access. Select <b>Any IP</b> to allow any remote hosts Select <b>Specific IP</b> to allow the remote host coming from a specific subnet. An IP address entered in this field and a selected <b>Subnet Mask</b> to compose the subnet.
<b>Service Port</b>	1. 80 for HTTP by default 2. 443 for HTTPS by default	This field is to specify a Service Port to HTTP or HTTPS connection. <b>Value Range: 1 ~ 65535.</b>
<b>Enabling the rule</b>	The box is unchecked by default.	Click <b>Enable</b> box to activate this rule.
<b>Save</b>	N/A	Click <b>Enable</b> box to activate this rule then save the settings.
<b>Undo</b>	N/A	Click <b>Undo</b> to cancel the settings

# 4G LTE M2M Router

## Chapter 6 Administration

### 6.1 Configure & Manage

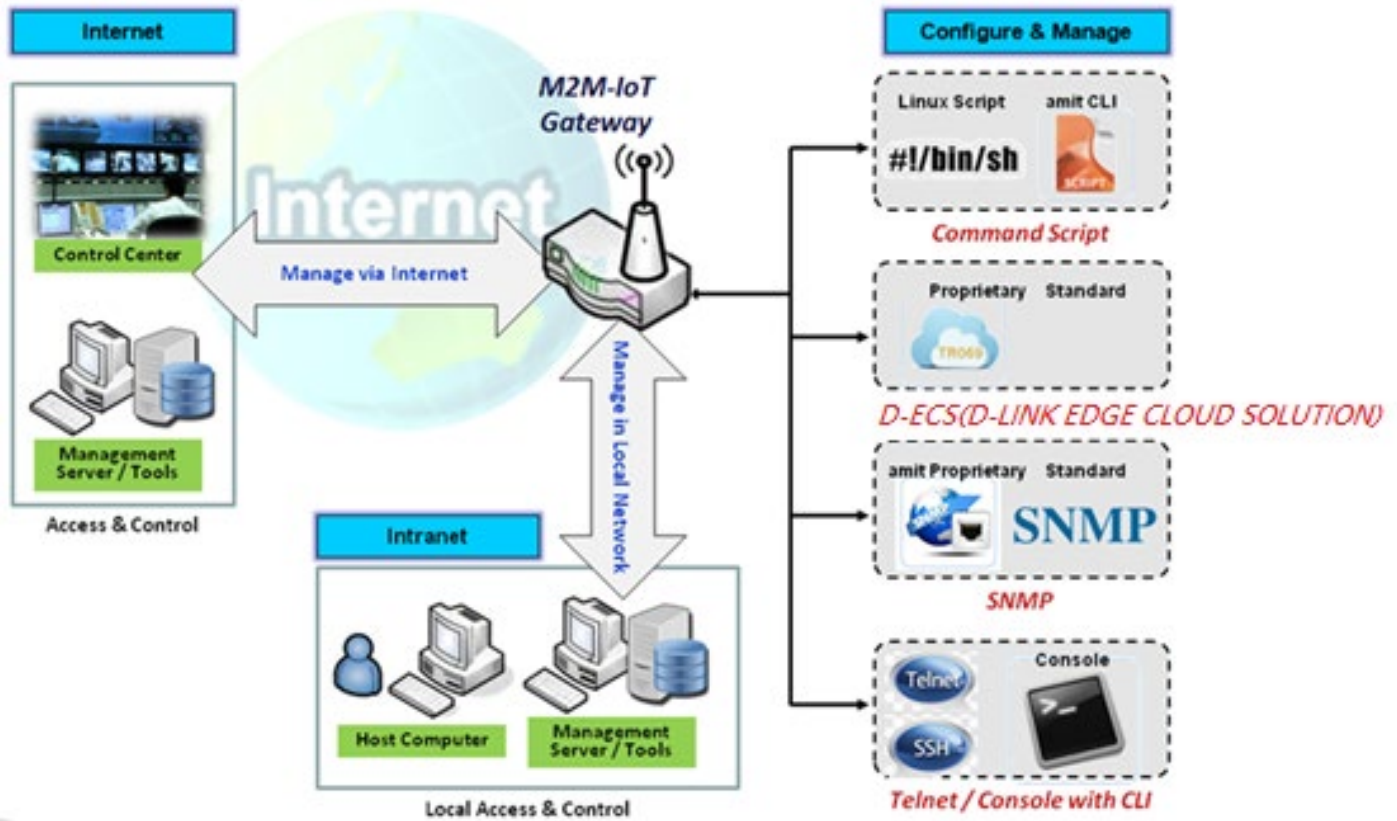

Configure & Manage refers to enterprise-wide administration of distributed systems including (and commonly in practice) computer systems. Centralized management has a time and effort trade-off that is related to the size of the company, the expertise of the IT staff, and the amount of technology being used. This device supports many system management protocols, such as Command Script, D-ECS (D-LINK EDGE CLOUD SOLUTION), SNMP, and Telnet with CLI. You can setup those configurations in the "Configure & Manage" section.

# 4G LTE M2M Router

## 6.1.1 Command Script

Command script configuration is the application that allows administrator to setup the pre-defined configuration in plain text style and apply configuration on startup.

Go to **Administration > Command Script > Configuration** Tab.

### Enable Command Script Configuration

Configuration	
Item	Setting
▶ Command Script	<input type="checkbox"/> Enable
▶ Backup Script	Via Web UI
▶ Upload Script	Via Web UI
▶ Script Name	<input type="text"/>
▶ Version	<input type="text"/>
▶ Description	<input type="text"/>
▶ Update time	2019-04-08T18:05:31

Configuration Item	Value setting	Description
<b>Command Script</b>	The box is unchecked by default	Check the <b>Enable</b> box to activate the Command Script function.
<b>Backup Script</b>	N/A	Click the <b>Via Web UI</b> or <b>Via Storage</b> button to backup the existed command script in a .txt file. You can specify the script file name in <b>Script Name</b> below.
<b>Upload Script</b>	N/A	Click the <b>Via Web UI</b> or <b>Via Storage</b> button to Upload the existed command script from a specified .txt file.
<b>Script Name</b>	1.An Optional setting 2.Any valid file name	Specify a script file name for script backup, or display the selected upload script file name. <b>Value Range:</b> 0 ~ 32 characters.
<b>Version</b>	1.An Optional setting 2.Any string	Specify the version number for the applied Command script. <b>Value Range:</b> 0 ~ 32 characters.
<b>Description</b>	1.An Optional setting 2.Any string	Enter a short description for the applied Command script.
<b>Update time</b>	N/A	It records the upload time for last commad script upload.

# 4G LTE M2M Router

## Edit/Backup Plain Text Command Script

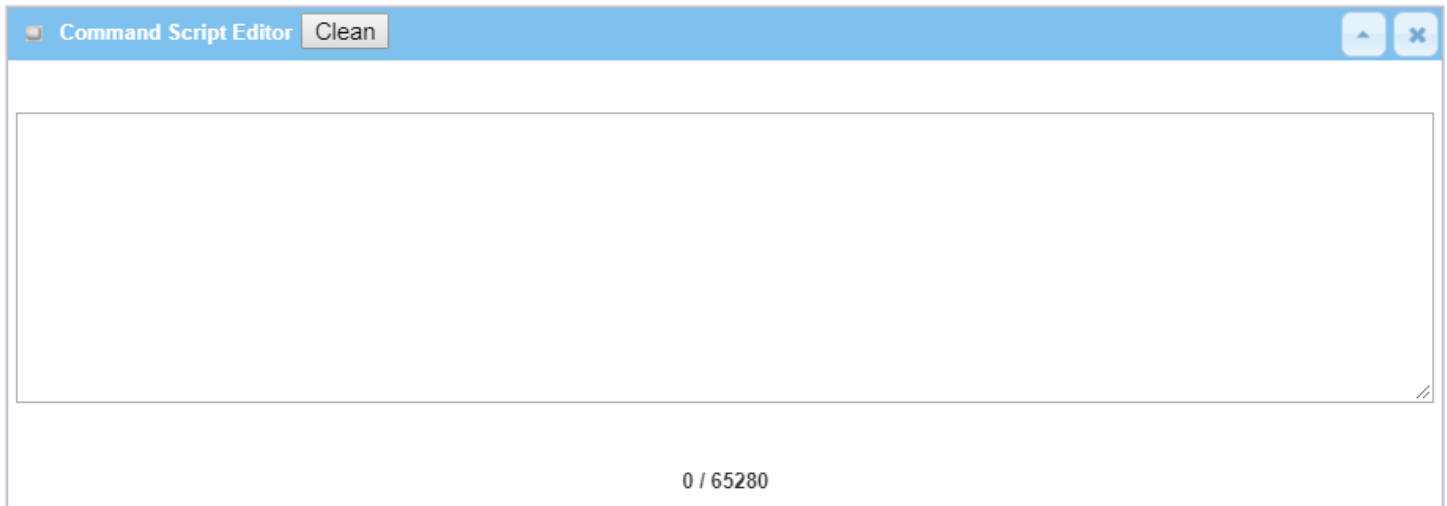

You can edit the plain text configuration settings in the configuration screen as above.

Plain Text Configuration		
Item	Value setting	Description
Clean	NA	Clean text area. (You should click <b>Save</b> button to further clean the configuration already saved in the system.)
Backup	NA	Backup and download configuration.
Save	NA	Save configuration

The supported plain text configuration items are shown in the following list. For the settings that can be executed with standard Linux commands, you can put them in a script file, and apply to the system configure with **STARTUP** command. For those configurations without corresponding Linux command set to configure, you can configure them with proprietary command set.

Configuration Content		
Key	Value setting	Description
<b>OPENVPN_ENABLED</b>	1 : enable 0 : disable	Enable or disable OpenVPN Client function.
<b>OPENVPN_DESCRIPTION</b>	A Must filled Setting	Specify the tunnel name for the OpenVPN Client connection.
<b>OPENVPN_PROTO</b>	udp tcp	Define the <b>Protocol</b> for the OpenVPN Client. <ul style="list-style-type: none"><li>• Select <b>TCP</b> or <b>TCP /UDP</b> -&gt;The OpenVPN will use TCP protocol, and <b>Port</b> will be set as 443 automatically.</li><li>• Select <b>UDP</b> -&gt; The OpenVPN will use UDP protocol, and <b>Port</b> will be set as 1194 automatically.</li></ul>
<b>OPENVPN_PORT</b>	A Must filled Setting	Specify the <b>Port</b> for the OpenVPN Client to use.
<b>OPENVPN_REMOTE_IPADDR</b>	IP or FQDN	Specify the <b>Remote IP/FQDN</b> of the peer OpenVPN Server for this OpenVPN Client tunnel. Fill in the IP address or FQDN.
<b>OPENVPN_PING_INTVL</b>	seconds	Specify the time interval for OpenVPN keep-alive checking.

# 4G LTE M2M Router

<b>OPENVPN_PING_TOUT</b>	seconds	Specify the timeout value for OpenVPN Client keep-alive checking.
<b>OPENVPN_COMP</b>	Adaptive	Specify the <b>LZO Compression</b> algorithm for OpenVPN client.
<b>OPENVPN_AUTH</b>	Static Key/TLS	Specify the authorization mode for the OpenVPN tunnel. <ul style="list-style-type: none"> <li>• <b>TLS</b> -&gt;The OpenVPN will use TLS authorization mode, and the following items <b>CA Cert.</b>, <b>Client Cert.</b> and <b>Client Key</b> need to specify as well.</li> </ul>
<b>OPENVPN_CA_CERT</b>	A Must filled Setting	Specify the Trusted CA certificate for the OpenVPN client. It will go through Base64 Conversion.
<b>OPENVPN_LOCAL_CERT</b>	A Must filled Setting	Specify the local certificate for OpenVPN client. It will go through Base64 Conversion.
<b>OPENVPN_LOCAL_KEY</b>	A Must filled Setting	Specify the local key for the OpenVPN client. It will go through Base64 Conversion.
<b>OPENVPN_EXTRA_OPTS</b>	Options	Specify the extra options setting for the OpenVPN client.
<b>IP_ADDR1</b>	Ip	Ethernet LAN IP
<b>IP_NETM1</b>	Net mask	Ethernet LAN MASK
<b>PPP_MONITORING</b>	1 : enable 0 : disable	When the Network Monitoring feature is enabled, the router will use DNS Query or ICMP to periodically check Internet connection – connected or disconnected.
<b>PPP_PING</b>	0 : DNS Query 1 : ICMP Query	With <b>DNS Query</b> , the system checks the connection by sending DNS Query packets to the destination specified in PPP_PING_IPADDR. With <b>ICMP Query</b> , the system will check connection by sending ICMP request packets to the destination specified in PPP_PING_IPADDR.
<b>PPP_PING_IPADDR</b>	IP	Specify an IP address as the target for sending DNS query/ICMP request.
<b>PPP_PING_INTVL</b>	seconds	Specify the time interval for between two DNS Query or ICMP checking packets.
<b>STARTUP</b>	Script file	For the configurations that can be configured with standard Linux commands, you can put them in a script file, and apply the script file with STARTUP command. For example, STARTUP=#!/bin/sh STARTUP=echo “startup done” > /tmp/demo

## Plain Text System Configuration with Telnet

In addition to the web-style plain text configuration as mentioned above, the gateway system also allow the configuration via Telnet CLI. Administrator can use the proprietary telnet command “**txtConfig**” and related action items to perform the plain system configuration.

The command format is: `txtConfig (action) [option]`

Action	Option	Description
<b>clone</b>	<i>Output file</i>	Duplicate the configuration content from database and stored as a configuration file. (ex: <code>txtConfig clone /tmp/config</code> ) The contents in the configuration file are the same as the plain text commands mentioned above. This action is exactly the same as performing the “Backup” plain text configuration.

# 4G LTE M2M Router

<b>commit</b>	a existing file	Commit the configuration content to database. (ex: <i>txtConfig commit /tmp/config</i> )
<b>enable</b>	NA	Enable plain text system config. (ex: <i>txtConfig enable</i> )
<b>disable</b>	NA	Disable plain text system config. (ex: <i>txtConfig disable</i> )
<b>run_immediately</b>	NA	Apply the configuration content that has been committed in database. (ex: <i>txtConfig run_immediately</i> )
<b>run_immediately</b>	a existing file	Assign a configuration file to apply. (ex: <i>txtConfig run_immediately /tmp/config</i> )

# 4G LTE M2M Router

## 6.1.2 D-ECS(D-LINK EDGE CLOUD SOLUTION)

D-ECS (D-Link Edge Cloud SOLUTION TR-069) allows users to manage DWM-313 device.

To Enable Remote D-ECS Service:

1. Select “Use Remote Service for Management” or access via webpage <https://us7-nv3-web.decs.dlink.com/web/index.jsp> to enable this feature.
3. Login using your ID and password.
4. The D-ECS can now show device information

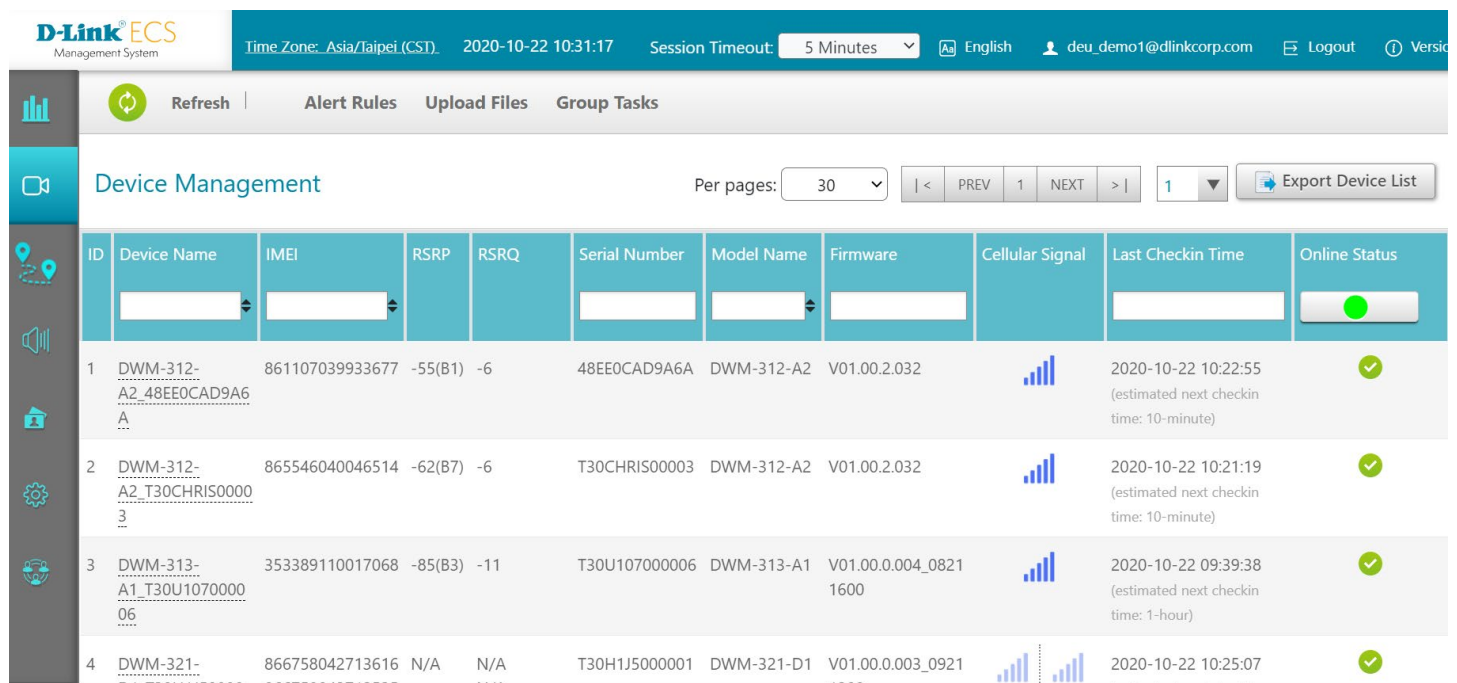

The screenshot displays the D-Link ECS Management System interface. At the top, it shows the D-Link ECS logo, the time zone (Asia/Taipei (CST)), the current date and time (2020-10-22 10:31:17), session timeout (5 Minutes), language (English), user (deu\_demo1@dlinkcorp.com), and options for Logout and Version. Below the header, there are navigation buttons for Refresh, Alert Rules, Upload Files, and Group Tasks. The main section is titled "Device Management" and includes a "Per pages:" dropdown set to 30, navigation buttons (PREV, 1, NEXT, >|), and an "Export Device List" button. The table below lists four devices with columns for ID, Device Name, IMEI, RSRP, RSRQ, Serial Number, Model Name, Firmware, Cellular Signal, Last Checkin Time, and Online Status.

ID	Device Name	IMEI	RSRP	RSRQ	Serial Number	Model Name	Firmware	Cellular Signal	Last Checkin Time	Online Status
1	DWM-312-A2_48EE0CAD9A6A	861107039933677	-55(B1)	-6	48EE0CAD9A6A	DWM-312-A2	V01.00.2.032		2020-10-22 10:22:55 (estimated next checkin time: 10-minute)	
2	DWM-312-A2_T30CHRIS00003	865546040046514	-62(B7)	-6	T30CHRIS00003	DWM-312-A2	V01.00.2.032		2020-10-22 10:21:19 (estimated next checkin time: 10-minute)	
3	DWM-313-A1_T30U107000006	353389110017068	-85(B3)	-11	T30U107000006	DWM-313-A1	V01.00.0.004_08211600		2020-10-22 09:39:38 (estimated next checkin time: 1-hour)	
4	DWM-321-D1_T30H1J5000001	866758042713616	N/A	N/A	T30H1J5000001	DWM-321-D1	V01.00.0.003_09211300		2020-10-22 10:25:07	

To enable Local D-ECS service:

1. Disable “Use Remote Service for Management”
2. Input your Local Service URL. For example: <http://35.173.33.16/ACS/tr069>
3. Input your Local Service IP STUN traffic. For example: 35.173.33.16

# 4G LTE M2M Router

**D-Link**  
DWM-313

Command Script | **Device Management** | SNMP | Telnet & SSH

Configuration

Item	Setting
▶ Device Management	<input checked="" type="checkbox"/> Enable
▶ Use Remote Service for Management	<input type="checkbox"/> Enable
▶ Input Local Service URL	<input type="text" value="http://35.173.33.16/ACS/tr069"/>
▶ Input Local Server IP STUN traffic	<input type="text" value="35.173.33.16"/>

Save | Undo

Navigation menu: Status, Basic Network, Object Definition, Field Communication, Security, Administration, **Configure & Manage**, System Operation, Diagnostic, Service

# 4G LTE M2M Router

## 6.1.3 SNMP

In brief, SNMP, the Simple Network Management Protocol, is a protocol designed to give a user the capability to remotely manage a computer network by polling and setting terminal values and monitoring network events.

In typical SNMP uses, one or more administrative computers, called managers, have the task of monitoring or managing a group of hosts or devices on a computer network. Each managed system executes, at all times, a software component called an agent which reports information via SNMP to the manager.

SNMP agents expose management data on the managed systems as variables. The protocol also permits active management tasks, such as modifying and applying a new configuration through remote modification of these variables. The variables accessible via SNMP are organized in hierarchies. These hierarchies, and other metadata (such as type and description of the variable), are described by Management Information Bases (MIBs).

The device supports several public MIBs and one private MIB for the SNMP agent. The supported MIBs are as follow: MIB-II (RFC 1213, Include IPv6), IF-MIB, IP-MIB, TCP-MIB, UDP-MIB, SMIv1 and SMIv2, SNMPv2-TM and SNMPv2-MIB, and AMIB (a Proprietary MIB)

### SNMP Management Scenario

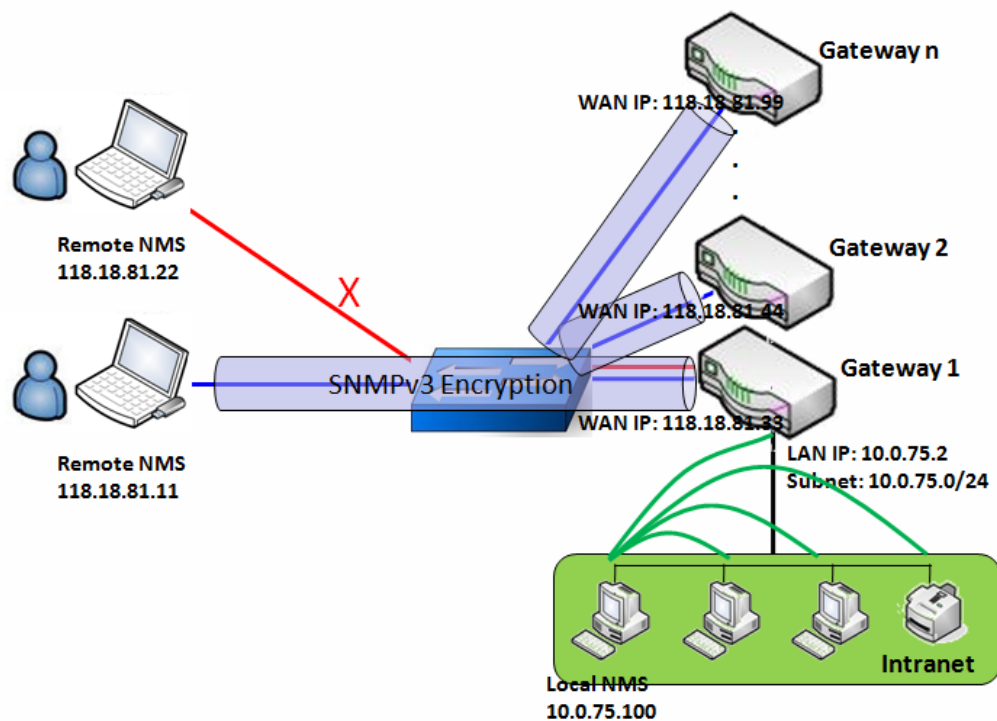

### Scenario Application Timing

There are two application scenarios of SNMP Network Management Systems (NMS). Local NMS is in

# 4G LTE M2M Router

the Intranet and manage all devices that support SNMP protocol in the Intranet. Another one is the Remote NMS to manage some devices whose WAN interfaces are connected together by using a switch or a router with UDP forwarding. If you want to manage some devices and they all have supported SNMP protocol, use either one application scenario, especially the management of devices in the Intranet. In managing devices in the Internet, the D-ECS (D-LINK EDGE CLOUD SOLUTION) is the better solution. Please refer to last sub-section.

## Scenario Description

The NMS server can monitor and configure the managed devices by using SNMP protocol, and those devices are located at where UDP packets can reach from NMS.

The managed devices report urgent trap events to the NMS servers.

Use SNMPv3 version of protocol can protected the transmitting of SNMP commands and responses.

The remote NMS with privilege IP address can manage the devices, but other remote NMS can't.

## Parameter Setup Example

Following tables list the parameter configuration as an example for the Gateway 1 in above diagram with "SNMP" enabling at LAN and WAN interfaces.

Use default value for those parameters that are not mentioned in the tables.

Configuration Path	[SNMP]-[Configuration]
SNMP Enable	■ LAN ■ WAN
Supported Versions	■ v1 ■ v2c ■ v3
Get / Set Community	ReadCommunity / WriteCommunity
Trap Event Receiver 1	118.18.81.11
WAN Access IP Address	118.18.81.11

Configuration Path	[SNMP]-[User Privacy Definition]		
ID	1	2	3
User Name	UserName1	UserName2	UserName3
Password	Password1	Password2	Disable
Authentication	MD5	SHA-1	Disable
Encryption	DES	Disable	Disable
Privacy Mode	authPriv	authNoPriv	noAuthNoPriv
Privacy Key	12345678	Disable	Disable
Authority	Read/Write	Read	Read
Enable	■ Enable	■ Enable	■ Enable

## Scenario Operation Procedure

In above diagram, the NMS server can manage multiple devices in the Intranet or a UDP-reachable network. The "Gateway 1" is one of the managed devices, and it has the IP address of 10.0.75.2 for

# 4G LTE M2M Router

LAN interface and 118.18.81.33 for WAN-1 interface. It serves as a NAT router.

At first stage, the NMS manager prepares related information for all managed devices and records them in the NMS system. Then NMS system gets the status of all managed devices by using SNMP get commands.

When the manager wants to configure the managed devices, the NMS system allows him to do that by using SNMP set commands. The "UserName1" account is used if the manager uses SNMPv3 protocol for configuring the "Gateway 1". Only the "UserName1" account can let the "Gateway 1" accept the configuration from the NMS since the authority of the account is "Read/Write".

Once a managed device has an urgent event to send, the device will issue a trap to the Trap Event Receivers. The NMS itself could be one among them.

If you want to secure the transmitted SNMP commands and responses between the NMS and the managed devices, use SNMPv3 version of protocol.

The remote NMS without privilege IP address can't manage the "Gateway 1", since "Gateway 1" allows only the NMS with privilege IP address can manage it via its WAN interface.

# 4G LTE M2M Router

## SNMP Setting

Go to **Administration > Configure & Manage > SNMP** tab.

The SNMP allows user to configure SNMP relevant setting which includes interface, version, access control and trap receiver.

### Enable SNMP

Configuration	
Item	Setting
▶ SNMP Enable	<input checked="" type="checkbox"/> LAN <input type="checkbox"/> WAN
▶ WAN Interface	All WANs ▾
▶ Supported Versions	<input checked="" type="checkbox"/> v1 <input checked="" type="checkbox"/> v2c <input type="checkbox"/> v3
▶ SNMP Port	161
▶ Limited Remote Access IP	IP Range ▾ <input type="text"/> - <input type="text"/> <input type="checkbox"/> Enable <input type="text"/> - <input type="text"/> <input type="checkbox"/> Enable <input type="text"/> - <input type="text"/> <input type="checkbox"/> Enable <input type="text"/> - <input type="text"/> <input type="checkbox"/> Enable <input type="text"/> - <input type="text"/> <input type="checkbox"/> Enable

SNMP Item	Value setting	Description
<b>SNMP Enable</b>	1.The boxes are unchecked by default	Select the interface for the SNMP and enable SNMP functions. When Check the <b>LAN</b> box, it will activate SNMP functions and you can access SNMP from LAN side; When Check the <b>WAN</b> box, it will activate SNMP functions and you can access SNMP from WAN side.
<b>WAN Interface</b>	1.A Must filled setting 2. <b>ALL WANs is selected by default</b>	Specify the WAN interface that a remote SNMP host can access to the device. By default, <b>All WANs</b> is selected, and there is no limitation for the WAN interface.
<b>Supported Versions</b>	1.A Must filled setting 2.The boxes are unchecked by default	Select the version for the SNMP When Check the <b>v1</b> box. It means you can access SNMP by version 1. When Check the <b>v2c</b> box. It means you can access SNMP by version 2c. When Check the <b>v3</b> box. It means you can access SNMP by version 3.
<b>SNMP Port</b>	1. String format: any	Specify the <b>SNMP Port</b> .

# 4G LTE M2M Router

	port number 2. The default SNMP port is <b>161</b> . 3. A Must filled setting	You can fill in any port number. But you must ensure the port number is not to be used. <i>Value Range: 1 ~ 65535.</i>
<b>Limited Remote Access IP</b>	1. String format: any IPv4 address 2. It is an optional item.	Specify the <b>Remote Access IP</b> for WAN and check the box to enable it as well. Select <b>Specific IP Address</b> , and fill in a certain IP address. It means only this IP address can access SNMP from LAN/WAN side. Select <b>IP Range</b> , and fill in a range of IP addresses. It means the IP address within specified range can access SNMP from LAN/WAN side.  If you left it as blank, it means any IP address can access SNMP from WAN side.
<b>Save</b>	N/A	Click <b>Save</b> to save the settings
<b>Undo</b>	N/A	Click <b>Undo</b> to cancel the settings

## Create/Edit Multiple Community

The SNMP allows you to custom your access control for version 1 and version 2 user. The router supports up to a maximum of 10 community sets.

Multiple Community List <span>Add</span> <span>Delete</span>			
ID	Community	Enable	Actions

When **Add** button is applied, **Multiple Community Rule Configuration** screen will appear.

Multiple Community Rule Configuration	
Item	Setting
▶ Community	Read Only ▾ <input type="text"/>
▶ Enable	<input checked="" type="checkbox"/> Enable

Multiple Community Rule Configuration		
Item	Value setting	Description
<b>Community</b>	1. <b>Read Only</b> is selected by default 2. A Must filled setting 3. String format: any text	Specify this version 1 or version v2c user's community that will be allowed <b>Read Only</b> (GET and GETNEXT) or <b>Read-Write</b> (GET, GETNEXT and SET) access respectively. The maximum length of the community is 32.
<b>Enable</b>	1.The box is checked by default	Click Enable to enable this version 1 or version v2c user.
<b>Save</b>	N/A	Click the <b>Save</b> button to save the configuration. But it does not apply to SNMP functions. When you return to the SNMP main page. It will show "Click on save button to apply your changes" remind user to click main page Save button.

# 4G LTE M2M Router

<b>Undo</b>	N/A	Click the <b>Undo</b> button to cancel the settings.
<b>Back</b>	N/A	Click the <b>Back</b> button to return to last page.

## Create/Edit User Privacy

The SNMP allows you to custom your access control for version 3 user. The router supports up to a maximum of 128 User Privacy sets.

User Privacy List										
ID	User Name	Password	Authentication	Encryption	Privacy Mode	Privacy Key	Authority	OID Filter Prefix	Enable	Actions

When **Add** button is applied, **User Privacy Rule Configuration** screen will appear.

User Privacy Rule Configuration	
Item	Setting
▶ User Name	<input type="text"/>
▶ Password	<input type="password"/>
▶ Authentication	None ▼
▶ Encryption	None ▼
▶ Privacy Mode	noAuthNoPriv ▼
▶ Privacy Key	<input type="password"/>
▶ Authority	Read ▼
▶ OID Filter Prefix	<input type="text" value="1"/>
▶ Enable	<input checked="" type="checkbox"/> Enable

User Privacy Rule Configuration		
Item	Value setting	Description
<b>User Name</b>	<ol style="list-style-type: none"> <li>A Must filled setting</li> <li>String format: any text</li> </ol>	Specify the <b>User Name</b> for this version 3 user. <b>Value Range:</b> 1 ~ 32 characters.
<b>Password</b>	<ol style="list-style-type: none"> <li>String format: any text</li> </ol>	When your <b>Privacy Mode</b> is <b>authNoPriv</b> or <b>authPriv</b> , you must specify the <b>Password</b> for this version 3 user. <b>Value Range:</b> 8 ~ 64 characters.
<b>Authentication</b>	<ol style="list-style-type: none"> <li><b>None</b> is selected by default</li> </ol>	When your <b>Privacy Mode</b> is <b>authNoPriv</b> or <b>authPriv</b> , you must specify the <b>Authentication</b> types for this version 3 user. Selected the authentication types <b>MD5/ SHA-1</b> to use.
<b>Encryption</b>	<ol style="list-style-type: none"> <li><b>None</b> is selected by default</li> </ol>	When your <b>Privacy Mode</b> is <b>authPriv</b> , you must specify the <b>Encryption</b> protocols for this version 3 user.

# 4G LTE M2M Router

		Selected the encryption protocols <b>DES / AES</b> to use.
<b>Privacy Mode</b>	1. <b>noAuthNoPriv</b> is selected by default	Specify the <b>Privacy Mode</b> for this version 3 user. Selected the <b>noAuthNoPriv</b> . You do not use any authentication types and encryption protocols. Selected the <b>authNoPriv</b> . You must specify the <b>Authentication</b> and <b>Password</b> . Selected the <b>authPriv</b> . You must specify the Authentication, Password, Encryption and Privacy Key.
<b>Privacy Key</b>	1. String format: any text	When your <b>Privacy Mode</b> is <b>authPriv</b> , you must specify the <b>Privacy Key</b> (8 ~ 64 characters) for this version 3 user.
<b>Authority</b>	1. <b>Read</b> is selected by default	Specify this version 3 user's <b>Authority</b> that will be allowed <b>Read Only</b> (GET and GETNEXT) or <b>Read-Write</b> (GET, GETNEXT and SET) access respectively.
<b>OID Filter Prefix</b>	1. The default value is 1 2. A Must filled setting 3. String format: any legal OID	The <b>OID Filter Prefix</b> restricts access for this version 3 user to the sub-tree rooted at the given OID. <b>Value Range: 1 ~2080768.</b>
<b>Enable</b>	1.The box is checked by default	Click <b>Enable</b> to enable this version 3 user.
<b>Save</b>	N/A	Click the <b>Save</b> button to save the configuration. But it does not apply to SNMP functions. When you return to the SNMP main page. It will show "Click on save button to apply your changes" remind user to click main page <b>Save</b> button.
<b>Undo</b>	N/A	Click the <b>Undo</b> button to cancel the settings
<b>Back</b>	N/A	Click the <b>X</b> button to return the last page.

## Create/Edit Trap Event Receiver

The SNMP allows you to custom your trap event receiver. The router supports up to a maximum of 4 Trap Event Receiver sets.

Trap Event Receiver List												
ID	Server IP	Server Port	SNMP Version	Community Name	User Name	Password	Privacy Mode	Authentication	Encryption	Privacy Key	Enable	Actions

When **Add** button is applied, **Trap Event Receiver Rule Configuration** screen will appear. The default SNMP Version is v1. The configuration screen will provide the version 1 must filled items.

# 4G LTE M2M Router

Trap Event Receiver Rule Configuration	
Item	Setting
▶ Server IP	<input type="text"/> (IP Address/FQDN)
▶ Server Port	<input type="text" value="162"/>
▶ SNMP Version	<input type="text" value="v1"/>
▶ Community Name	<input type="text"/>
▶ Enable	<input checked="" type="checkbox"/> Enable

When you selected v2c, the configuration screen is exactly the same as that of v1, except the version.

When you selected v3, the configuration screen will provide more setting items for the version 3 Trap.

Trap Event Receiver Rule Configuration	
Item	Setting
▶ Server IP	<input type="text"/> (IP Address/FQDN)
▶ Server Port	<input type="text" value="162"/>
▶ SNMP Version	<input type="text" value="v3"/>
▶ Community Name	<input type="text"/>
▶ User Name	<input type="text"/>
▶ Password	<input type="text"/>
▶ Privacy Mode	<input type="text" value="noAuthNoPriv"/>
▶ Authentication	<input type="text" value="None"/>
▶ Encryption	<input type="text" value="None"/>
▶ Privacy Key	<input type="text"/>
▶ Enable	<input checked="" type="checkbox"/> Enable

Trap Event Receiver Rule Configuration		
Item	Value setting	Description
<b>Server IP</b>	<ol style="list-style-type: none"> <li>1. A Must filled setting</li> <li>2. String format: any IPv4 address or FQDN</li> </ol>	Specify the trap <b>Server IP</b> or <b>FQDN</b> . The DUT will send trap to the server IP/FQDN.
<b>Server Port</b>	<ol style="list-style-type: none"> <li>1. String format: any port number</li> <li>2. The default SNMP trap port is 162</li> <li>3. A Must filled setting</li> </ol>	Specify the trap <b>Server Port</b> . You can fill in any port number. But you must ensure the port number is not to be used. <i>Value Range: 1 ~ 65535.</i>
<b>SNMP Version</b>	<ol style="list-style-type: none"> <li>1. v1 is selected by</li> </ol>	Select the version for the trap

# 4G LTE M2M Router

	default	<p>Selected the <b>v1</b>.</p> <p>The configuration screen will provide the version 1 must filled items.</p> <p>Selected the <b>v2c</b>.</p> <p>The configuration screen will provide the version 2c must filled items.</p> <p>Selected the <b>v3</b>.</p> <p>The configuration screen will provide the version 3 must filled items.</p>
<b>Community Name</b>	<ol style="list-style-type: none"> <li>1. A <b>v1</b> and <b>v2c</b> Must filled setting</li> <li>2. String format: any text</li> </ol>	<p>Specify the <b>Community Name</b> for this version 1 or version v2c trap.</p> <p><b>Value Range:</b> 1 ~ 32 characters.</p>
<b>User Name</b>	<ol style="list-style-type: none"> <li>1. A <b>v3</b> Must filled setting</li> <li>2. String format: any text</li> </ol>	<p>Specify the <b>User Name</b> for this version 3 trap.</p> <p><b>Value Range:</b> 1 ~ 32 characters.</p>
<b>Password</b>	<ol style="list-style-type: none"> <li>1. A <b>v3</b> Must filled setting</li> <li>2. String format: any text</li> </ol>	<p>When your <b>Privacy Mode</b> is <b>authNoPriv</b> or <b>authPriv</b>, you must specify the <b>Password</b> for this version 3 trap.</p> <p><b>Value Range:</b> 8 ~ 64 characters.</p>
<b>Privacy Mode</b>	<ol style="list-style-type: none"> <li>1. A <b>v3</b> Must filled setting</li> <li>2. <b>noAuthNoPriv</b> is selected by default</li> </ol>	<p>Specify the <b>Privacy Mode</b> for this version 3 trap.</p> <p>Selected the <b>noAuthNoPriv</b>.</p> <p>You do not use any authentication types and encryption protocols.</p> <p>Selected the <b>authNoPriv</b>.</p> <p>You must specify the <b>Authentication</b> and <b>Password</b>.</p> <p>Selected the <b>authPriv</b>.</p> <p>You must specify the Authentication, Password, Encryption and Privacy Key.</p>
<b>Authentication</b>	<ol style="list-style-type: none"> <li>1. A <b>v3</b> Must filled setting</li> <li>2. <b>None</b> is selected by default</li> </ol>	<p>When your <b>Privacy Mode</b> is <b>authNoPriv</b> or <b>authPriv</b>, you must specify the <b>Authentication</b> types for this version 3 trap.</p> <p>Selected the authentication types <b>MD5/ SHA-1</b> to use.</p>
<b>Encryption</b>	<ol style="list-style-type: none"> <li>1. A <b>v3</b> Must filled setting</li> <li>2. <b>None</b> is selected by default</li> </ol>	<p>When your <b>Privacy Mode</b> is <b>authPriv</b>, you must specify the <b>Encryption</b> protocols for this version 3 trap.</p> <p>Selected the encryption protocols <b>DES / AES</b> to use.</p>
<b>Privacy Key</b>	<ol style="list-style-type: none"> <li>1. A <b>v3</b> Must filled setting</li> <li>2. String format: any text</li> </ol>	<p>When your <b>Privacy Mode</b> is <b>authPriv</b>, you must specify the <b>Privacy Key</b> (8 ~ 64 characters) for this version 3 trap.</p>
<b>Enable</b>	1.The box is checked by default	Click <b>Enable</b> to enable this trap receiver.
<b>Save</b>	N/A	Click the <b>Save</b> button to save the configuration. But it does not apply to SNMP functions. When you return to the SNMP main page. It will show “Click on save button to apply your changes” remind user to click main page <b>Save</b> button.
<b>Undo</b>	N/A	Click the <b>Undo</b> button to cancel the settings.
<b>Back</b>	N/A	Click the <b>X</b> button to return to last page.

# 4G LTE M2M Router

## Specify SNMP MIB-2 System

If required, you can also specify the required information for the MIB-2 System.

SNMP MIB-2 System	
Item	Setting
▶ sysContact	<input type="text"/>
▶ sysLocation	<input type="text"/>

Item	Value setting	Description
<b>sysContact</b>	<ol style="list-style-type: none"><li>1. An Optional filled setting</li><li>2. String format: any text</li></ol>	Specify the contact information for MIB-2 system. <b><i>Value Range:</i></b> 0 ~ 64 characters.
<b>sysLocation</b>	<ol style="list-style-type: none"><li>1. An Optional filled setting</li><li>2. String format: any text</li></ol>	Specify the location information for MIB-2 system. <b><i>Value Range:</i></b> 0 ~ 64 characters.

## Edit SNMP Options

If you use some particular private MIB, you must fill the enterprise name, number and OID.

Options	
Item	Setting
▶ Enterprise Name	<input type="text" value="Default"/>
▶ Enterprise Number	<input type="text" value="12823"/>
▶ Enterprise OID	1.3.6.1.4.1. <input type="text" value="12823.4.4.9"/>

Item	Value setting	Description
<b>Enterprise Name</b>	<ol style="list-style-type: none"><li>1. The default value is <b>Default</b></li><li>2. A Must filled setting</li><li>3. String format: any text</li></ol>	Specify the <b>Enterprise Name</b> for the particular private MIB. <b><i>Value Range:</i></b> 1 ~ 10 characters, and only string with A~Z, a~z, 0~9, '-', '_'.
<b>Enterprise Number</b>	The default value is <b>12823</b> (Default Enterprise	Specify the <b>Enterprise Number</b> for the particular private MIB. <b><i>Value Range:</i></b> 1 ~ 2080768.

# 4G LTE M2M Router

	Number) 2. A Must filled setting 3. String format: any number	
<b>Enterprise OID</b>	1. The default value is 1.3.6.1.4.1.12823.4.4.9 (Default Enterprise OID) 2. A Must filled setting 3. String format: any legal OID	Specify the <b>Enterprise OID</b> for the particular private MIB. The range of the each OID number is 1-2080768. The maximum length of the enterprise OID is 31. The seventh number must be identical with the enterprise number.
<b>Save</b>	N/A	Click the <b>Save</b> button to save the configuration and apply your changes to SNMP functions.
<b>Undo</b>	N/A	Click the <b>Undo</b> button to cancel the settings.

# 4G LTE M2M Router

## 6.1.4 Telnet & SSH

A command-line interface (CLI), also known as command-line user interface, and console user interface are means of interacting with a computer program where the user (or client) issues commands to the program in the form of successive lines of text (command lines). The interface is usually implemented with a command line shell, which is a program that accepts commands as text input and converts commands to appropriate operating system functions. Programs with command-line interfaces are generally easier to automate via scripting. The device supports both Telnet and SSH (Secure Shell) CLI with default service port 23 and 22, respectively.

### Telnet & SSH Scenario

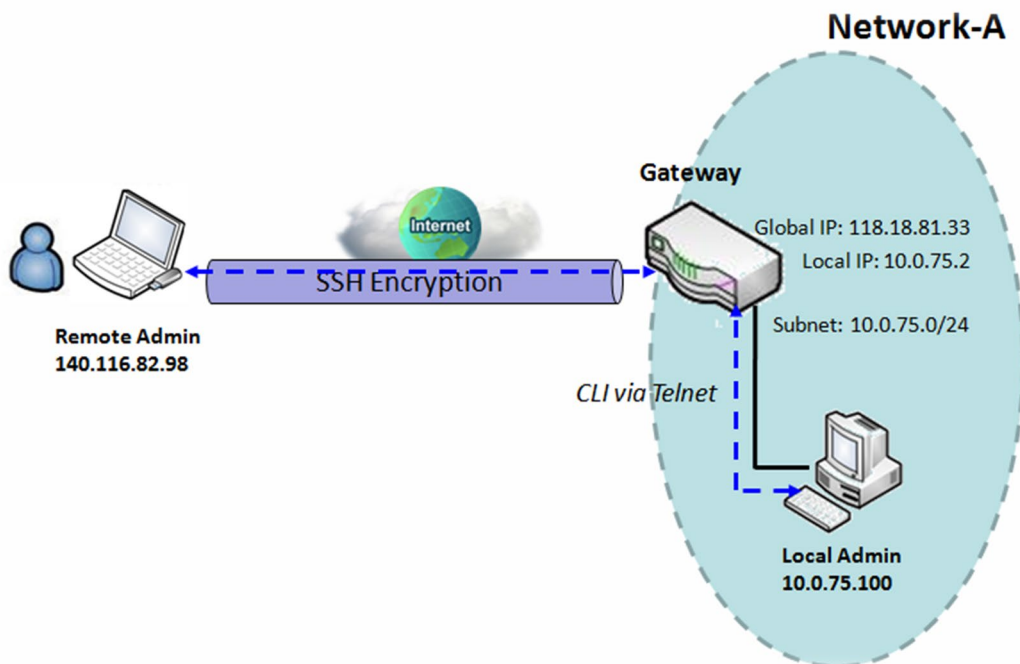

#### Scenario Application Timing

When the administrator of the gateway wants to manage it from remote site in the Intranet or Internet, he may use "Telnet with CLI" function to do that by using "Telnet" or "SSH" utility.

#### Scenario Description

The Local Admin or the Remote Admin can manage the Gateway by using "Telnet" or "SSH" utility with privileged user name and password.

The data packets between the Local Admin and the Gateway or between the Remote Admin and the Gateway can be plain texts or encrypted texts. Suggest they are plain texts in the Intranet for Local Admin to use "Telnet" utility, and encrypted texts in the Internet for Remote Admin to use "SSH"

# 4G LTE M2M Router

utility.

## Parameter Setup Example

Following table lists the parameter configuration as an example for the Gateway in above diagram with "Telnet with CLI" enabling at LAN and WAN interfaces.

Use default value for those parameters that are not mentioned in the table.

Configuration Path	[Telnet & SSH]-[Configuration]
Telnet	LAN: <input checked="" type="checkbox"/> <b>Enable</b> WAN: <input type="checkbox"/> <b>Enable</b> Service Port: <b>23</b>
SSH	LAN: <input checked="" type="checkbox"/> <b>Enable</b> WAN: <input checked="" type="checkbox"/> <b>Enable</b> Service Port: <b>22</b>

## Scenario Operation Procedure

In above diagram, "Local Admin" or "Remote Admin" can manage the "Gateway" in the Intranet or Internet. The "Gateway" is the gateway of Network-A, and the subnet of its Intranet is 10.0.75.0/24. It has the IP address of 10.0.75.2 for LAN interface and 118.18.81.33 for WAN-1 interface. It serves as a NAT gateway.

The "Local Admin" in the Intranet uses "Telnet" utility with privileged account to login the Gateway.

Or the "Remote Admin" in the Internet uses "SSH" utility with privileged account to login the Gateway.

The administrator of the gateway can control the device as like he is in front of the gateway.

# 4G LTE M2M Router

## Telnet & SSH Setting

Go to Administration > Configure & Manage > Telnet & SSH tab.

The Telnet & SSH setting allows administrator to access this device through the traditional Telnet or SSH Telnet program. Before you can telnet (login) to the device, please configure the related settings with care.

Configuration	
Item	Setting
▶ Telnet	LAN <input checked="" type="checkbox"/> Enable WAN <input type="checkbox"/> Enable ( WAN-1 <input checked="" type="checkbox"/> WAN-4 <input type="checkbox"/> ) <input type="text"/> Service Port <input type="text" value="23"/>
▶ SSH	LAN <input checked="" type="checkbox"/> Enable WAN <input type="checkbox"/> Enable ( WAN-1 <input checked="" type="checkbox"/> WAN-4 <input type="checkbox"/> ) <input type="text"/> Service Port <input type="text" value="22"/>

Configuration		
Item	Value setting	Description
<b>Telnet</b>	1. The LAN Enable box is checked by default. 2. By default <b>Service Port</b> is 23.	Check the <b>Enable</b> box to activate the Telnet function for connecting from LAN or WAN interfaces. You can set which number of <b>Service Port</b> you want to provide for the corresponding service. <b>Value Range: 1 ~65535.</b>
<b>SSH</b>	3. The LAN Enable box is checked by default. 4. By default <b>Service Port</b> is 22.	Check the <b>Enable</b> box to activate the SSH Telnet function for connecting from LAN or WAN interfaces. You can set which number of <b>Service Port</b> you want to provide for the corresponding service. <b>Value Range: 1 ~65535.</b>
<b>Save</b>	N/A	Click <b>Save</b> to save the settings
<b>Undo</b>	N/A	Click <b>Undo</b> to cancel the settings

**Note:** The Telnet/SSH login password is the same one as the administrator's login password for the device web GUI.

# 4G LTE M2M Router

## 6.2 System Operation

System Operation allows the network administrator to manage system, settings such as web-based utility access password change, system information, system time, system log, firmware/configuration backup & restore, and reset & reboot.

### 6.2.1 Password & MMI

Go to **Administration > System Operation > Password & MMI** tab.

#### Setup Host Name

Host Name screen allows network administrator to setup / change the host name of the gateway. Click the **Modify** button and provide the new username setting.

Host Name	
Item	Setting
▶ Host Name	<input type="text"/>

Username Configuration		
Item	Value setting	Description
<b>Host Name</b>	1. An Optional setting 2. It is blanked by default	Enter the host name of the gateway.
<b>Save</b>	N/A	Click <b>Save</b> button to save the settings
<b>Undo</b>	N/A	Click <b>Undo</b> button to cancel the settings

#### Change UserName

Username screen allows network administrator to change the web-based MMI login account to access gateway. Click the **Modify** button and provide the new username setting.

Username	
Item	Setting
▶ Username	admin <input type="button" value="Modify"/>
▶ New Username	<input type="text"/>
▶ Password	<input type="text"/>

# 4G LTE M2M Router

Username Configuration		
Item	Value setting	Description
<b>Username</b>	1. The default Username for web-based MMI is 'admin'.	Display the current MMI login account (Username).
<b>New Username</b>	String: any text	Enter new Username to replace the current setting.
<b>Password</b>	String: any text	Enter current password to verify if you have the permission to change the username setting.
<b>Save</b>	N/A	Click <b>Save</b> button to save the settings
<b>Undo</b>	N/A	Click <b>Undo</b> button to cancel the settings

## Change Password

Change password screen allows network administrator to change the web-based MMI login password to access gateway.

 Password ▲ ✕

Item	Setting
▶ Old Password	<input type="text"/>
▶ New Password	<input type="text"/>
▶ New Password Confirmation	<input type="text"/>

Password Configuration		
Item	Value setting	Description
<b>Old Password</b>	1. String: any text 2. The default password for web-based MMI is 'admin'.	Enter the current password to enable you unlock to change password.
<b>New Password</b>	String: any text	Enter new password
<b>New Password Confirmation</b>	String: any text	Enter new password again to confirm
<b>Save</b>	N/A	Click <b>Save</b> button to save the settings
<b>Undo</b>	N/A	Click <b>Undo</b> button to cancel the settings

## Change MMI Setting for Accessing

This is the gateway's web-based MMI access which allows administrator to access the gateway for management. The gateway's web-based MMI will automatically logout when the idle time has elapsed. The

# 4G LTE M2M Router

setting allows administrator to enable automatic logout and set the logout idle time. When the login timeout is disabled, the system won't logout the administrator automatically.

Item	Setting
▶ Login	Password-Guessing Attack & MAX: <input type="text" value="3"/> (times)
▶ Login Timeout	<input checked="" type="checkbox"/> Enable <input type="text" value="300"/> (seconds)
▶ GUI Access Protocol	<input type="text" value="http/https"/>
▶ HTTPs Certificate Setup	<input checked="" type="radio"/> default <input type="radio"/> Select from Certificate List Certificate: <input type="text" value="TrustedCert0"/> Key: <input type="text" value="TrustedKey0"/>
▶ HTTP Compression	<input checked="" type="checkbox"/> gzip <input type="checkbox"/> deflate
▶ HTTP Binding	<input checked="" type="checkbox"/> DHCP 1
▶ System Boot Mode	<input type="text" value="Normal Mode"/>

MMI Configuration		
Item	Value setting	Description
<b>Login</b>	3 times is set by default	Enter the login trial counting value. <b><i>Value Range:</i></b> 3 ~ 10. If someone tried to login the web GUI with incorrect password for more than the counting value, an warning message " <b><i>Already reaching maximum Password-Guessing times, please wait a few seconds!</i></b> " will be displayed and ignore the following login trials.
<b>Login Timeout</b>	The Enable box is checked, and 300 is set by default.	Check the Enable box to activate the auto logout function, and specify the maximum idle time as well. <b><i>Value Range:</i></b> 30 ~ 65535.
<b>GUI Access Protocol</b>	<b>http/https</b> is selected by default.	Select the protocol that will be used for GUI access. It can be <b>http/https</b> , <b>http only</b> , or <b>https only</b> .
<b>HTTPs Certificate Setup</b>	The <b>default</b> box is selected by default	If the https Access Protocol is selected, the HTTPs Certificate Setup option will be available for further configuration. You can leave it as default or select a expected certificate and key from the drop down list. Refer to <b>Object Definition &gt; Certificate</b> Section for the Certificate configuration.
<b>HTTP Compression</b>	The box is unchecked by default.	Check the box ( <b>gzip</b> , or <b>deflate</b> ) if any comprerssion method is preferred.
<b>HTTP Binding</b>	1. An Optional setting 2. DHCP-1 is checked by default	Select the DHCP Server to bind with http access.
<b>System Boot Mode</b>	<b>Normal Mode</b> is selected	Select the system boot mode that will be adopted to boot up the device.

# 4G LTE M2M Router

	by default.	<b>Normal Mode:</b> It takes longer boot up time, with complete firmware image check during the device booting.
<b>Save</b>	N/A	Click <b>Save</b> button to save the settings
<b>Undo</b>	N/A	Click <b>Undo</b> button to cancel the settings

# 4G LTE M2M Router

## 6.2.2 System Information

System Information screen gives network administrator a quick look up on the device information for the purchased gateway.

Go to **Administration > System Operation > System Information** tab.

The screenshot shows the D-Link DWM-313 web interface. The navigation menu on the left includes: Status, Basic Network, Object Definition, Field Communication, Security, Administration, Configure & Manage, System Operation (selected), and Diagnostic. The main content area has a breadcrumb trail: Password & MMI > System Information > System Time > System Log > Backup & Restore > Reboot & Reset. The 'System Information' section displays the following data:

Item	
Model Name	DWM-313
Device Serial Number	T30U107000003
Kernel Version	2.6.36
FW Version	V01.00.0.003_06201000
System Time	Mon, 16 Mar 2020 00:04:02 +0000
Device Up-Time	0day 0hr 4min 14sec

A 'Refresh' button is located at the bottom right of the system information table.

System Information		
Item	Value Setting	Description
<b>Model Name</b>	N/A	It displays the model name of this product.
<b>Device Serial Number</b>	N/A	It displays the serial number of this product.
<b>Kernel Version</b>	N/A	It displays the Linux kernel version of the product
<b>FW Version</b>	N/A	It displays the firmware version of the product
<b>Memory Usage</b>	N/A	It displays the percentage of device memory utilization.
<b>System Time</b>	N/A	It displays the current system time that you browsed this web page.
<b>Device Up-Time</b>	N/A	It displays the statistics for the device up-time since last boot up.
<b>Refresh</b>	N/A	Click the Refresh button to update the system Information immediately.

# 4G LTE M2M Router

## 6.2.3 System Time

The gateway provides manually setup and auto-synchronized approaches for the administrator to setup the system time for the gateway. The time supported synchronization methods can be Time Server, Manual, PC, Cellular Module, or GPS Signal. Select the method first, and then configure rest settings.

Instead of manually configuring the system time for the gateway, there are two simple and quick solutions for you to set the correct time information and set it as the system time for the gateway.

The first one is “Sync with Timer Server”. Based on your selection of time zone and time server in above time information configuration window, system will communicate with time server by NTP Protocol to get system date and time after you click on the **Synchronize immediately** button.

The second one is “Sync with my PC”. Select the method and the system will synchronize its date and time to the time of the administration PC.

Go to **Administration > System Operation > System Time** tab.

### Synchronize with Time Server

System Time Configuration	
Item	Setting
▶ Synchronization method	Time Server ▼
▶ Time Zone	(GMT+00:00) Greenwich Mean Time: Dublin, Edinburgh, Lisbon, London ▼
▶ Auto-synchronization	Time Server: <input type="text"/> Available Time Servers (RFC-868): Auto ▼
▶ Daylight Saving Time	<input type="checkbox"/> Enable
▶ NTP Service	<input type="checkbox"/> Enable
▶ Synchronize immediately	Active

System Time Information		
Item	Value Setting	Description
<b>Synchronization method</b>	1. A Must-filled item. 2. <b>Time Server</b> is selected by default.	<b>Select the Time Server as the synchronization method for the system time.</b>
<b>Time Zone</b>	1. A Must-filled item. 2. <b>GMT+00 :00</b> is selected by default.	<b>Select a time zone where this device locates.</b>
<b>Auto-synchronization</b>	1. A Must-filled item. 2. Auto is selected by	<b>Enter the IP or FQDN for the NTP time server you expected, or leave it as auto mode so that the available server will be used for time</b>

# 4G LTE M2M Router

	default.	synchronization one by one.
<b>Daylight Saving Time</b>	1. It is an optional item. 2. Un-checked by default	Check the Enable button to activate the daylight saving function. When you enabled this function, you have to specify the start date and end date for the daylight saving time duration.
<b>NTP Service</b>	1. It is an optional item. 2. Un-checked by default	Check the Enable button to activate the NTP Service function. When you enabled this function, the gateway can provide NTP server service for its local connected devices.
<b>Synchronize immediately</b>	N/A	Click the Active button to synchronize the system time with specified time server immediately.
<b>Save</b>	N/A	Click the Save button to save the settings.
<b>Refresh</b>	N/A	Click the Refresh button to update the system time immediately.

Note: Remember to select a correct time zone for the device, otherwise, you will just get the UTC (Coordinated Universal Time) time, not the local time for the device.

## Synchronize with Manually Setting

System Time Configuration
▲ ✕

Item	Setting
▶ Synchronization method	Manual ▼
▶ Time Zone	(GMT+00:00) Greenwich Mean Time: Dublin, Edinburgh, Lisbon, London ▼
▶ Daylight Saving Time	<input type="checkbox"/> Enable
▶ Set Date & Time Manually	2019 ▼ / April ▼ / 18 ▼ (Year/Month/Day)
	16 ▼ : 24 ▼ : 27 ▼ (Hour:Minute:Second)
▶ NTP Service	<input type="checkbox"/> Enable

System Time Information		
Item	Value Setting	Description
<b>Synchronization method</b>	1. A Must-filled item. 2. <b>Time Server</b> is selected by default.	Select the <b>Manual</b> as the synchronization method for the system time. It means administrator has to set the Date & Time manually.
<b>Time Zone</b>	1. A Must-filled item. 2. <b>GMT+00 :00</b> is selected by default.	Select a time zone where this device locates.
<b>Daylight Saving Time</b>	1. It is an optional item. 2. Un-checked by default	Check the Enable button to activate the daylight saving function. When you enabled this function, you have to specify the start date and end date for the daylight saving time duration.
<b>Set Date &amp; Time Manually</b>	1. It is an optional item.	Manually set the date (Year/Month/Day) and time (Hour:Minute:Second) as the system time.
<b>NTP Service</b>	1. It is an optional item.	Check the Enable button to activate the NTP Service function.

# 4G LTE M2M Router

	2. Un-checked by default	<b>When you enabled this function, the gateway can provide NTP server service for its local connected devices.</b>
<b>Save</b>	N/A	<b>Click the Save button to save the settings.</b>

## Synchronize with PC

System Time Configuration
▲ ✕

Item	Setting
▶ Synchronization method	PC ▼
▶ NTP Service	<input type="checkbox"/> Enable
▶ Synchronize immediately	Active

System Time Information		
Item	Value Setting	Description
<b>Synchronization method</b>	1. A Must-filled item. 2. <b>Time Server</b> is selected by default.	<b>Select PC as the synchronization method for the system time to let system synchronize its date and time to the time of the administration PC.</b>
<b>NTP Service</b>	1. It is an optional item. 2. Un-checked by default	<b>Check the Enable button to activate the NTP Service function. When you enabled this function, the gateway can provide NTP server service for its local connected devices.</b>
<b>Synchronize immediately</b>	N/A	<b>Click the Active button to synchronize the system time with specified time server immediately.</b>
<b>Save</b>	N/A	<b>Click the Save button to save the settings.</b>
<b>Refresh</b>	N/A	<b>Click the Refresh button to update the system time immediately.</b>

# 4G LTE M2M Router

## Synchronize with Cellular Time Service

System Time Configuration	
Item	Setting
▶ Synchronization method	Cellular Module ▾
▶ Time Zone	(GMT+00:00) Greenwich Mean Time: Dublin, Edinburgh, Lisbon, London ▾
▶ NTP Service	<input type="checkbox"/> Enable
▶ Synchronize immediately	Active

System Time Information		
Item	Value Setting	Description
<b>Synchronization method</b>	<ol style="list-style-type: none"><li>1. A Must-filled item.</li><li>2. <b>Time Server</b> is selected by default.</li></ol>	<b>Select Cellular Module as the synchronization method for the system time to let system synchronize its date and time to the time provided from the connected mobile ISP.</b> <b>Note: this option is only available for the product with Cellular WAN interface.</b>
<b>Time Zone</b>	<ol style="list-style-type: none"><li>1. A Must-filled item.</li><li>2. <b>GMT+00 :00</b> is selected by default.</li></ol>	<b>Select a time zone where this device locates.</b>
<b>NTP Service</b>	<ol style="list-style-type: none"><li>1. It is an optional item.</li><li>2. Un-checked by default</li></ol>	<b>Check the Enable button to activate the NTP Service function.</b> <b>When you enabled this function, the gateway can provide NTP server service for its local connected devices.</b>
<b>Synchronize immediately</b>	N/A	<b>Click the Active button to synchronize the system time with specified time server immediately.</b>
<b>Save</b>	N/A	<b>Click the Save button to save the settings.</b>
<b>Refresh</b>	N/A	<b>Click the Refresh button to update the system time immediately.</b>

# 4G LTE M2M Router

## Synchronize with GPS Time Service

System Time Configuration	
Item	Setting
▶ Synchronization method	GPS Signal ▼
▶ Time Zone	(GMT+00:00) Greenwich Mean Time: Dublin, Edinburgh, Lisbon, London ▼
▶ NTP Service	<input type="checkbox"/> Enable
▶ Synchronize immediately	Active

System Time Information		
Item	Value Setting	Description
<b>Synchronization method</b>	<ol style="list-style-type: none"><li>1. A Must-filled item.</li><li>2. <b>Time Server</b> is selected by default.</li></ol>	<p>Select <b>GPS Signal</b> as the synchronization method for the system time to let system synchronize its date and time to the time provided from the GNSS service.</p> <p><b>Note: this option is only available for the product with GNSS interface.</b></p>
<b>Time Zone</b>	<ol style="list-style-type: none"><li>1. A Must-filled item.</li><li>2. <b>GMT+00 :00</b> is selected by default.</li></ol>	Select a time zone where this device locates.
<b>NTP Service</b>	<ol style="list-style-type: none"><li>1. It is an optional item.</li><li>2. Un-checked by default</li></ol>	<p>Check the <b>Enable</b> button to activate the NTP Service function.</p> <p>When you enabled this function, the gateway can provide NTP server service for its local connected devices.</p>
<b>Synchronize immediately</b>	N/A	Click the <b>Active</b> button to synchronize the system time with specified time server immediately.
<b>Save</b>	N/A	Click the <b>Save</b> button to save the settings.
<b>Refresh</b>	N/A	Click the <b>Refresh</b> button to update the system time immediately.

# 4G LTE M2M Router

## 6.2.4 System Log

System Log screen contains various event log tools facilitating network administrator to perform local event logging and remote reporting.

Go to **Administration > System Operation > System Log** tab.

Item	Setting
▶ Web Log Type Category	<input checked="" type="checkbox"/> System <input checked="" type="checkbox"/> Attacks <input checked="" type="checkbox"/> Drop <input checked="" type="checkbox"/> Login message <input type="checkbox"/> Debug
▶ Email Alert	<input type="checkbox"/> Enable Server: <input type="text" value="--- Option ---"/> <input type="button" value="Add Object"/> E-mail Addresses: <input type="text"/> Subject: <input type="text"/> Log type Category: <input type="checkbox"/> System <input type="checkbox"/> Attacks <input type="checkbox"/> Drop <input type="checkbox"/> Login message <input type="checkbox"/> Debug
▶ Syslog	<input type="checkbox"/> Enable   Server: <input type="text" value="--- Option ---"/> <input type="button" value="Add Object"/> Log type Category: <input type="checkbox"/> System <input type="checkbox"/> Attacks <input type="checkbox"/> Drop <input type="checkbox"/> Login message <input type="checkbox"/> Debug
▶ Log to Storage	<input checked="" type="checkbox"/> Enable Select Device: <input type="text" value="Internal"/> Log file name: <input type="text" value="syslog"/> Split file: <input type="checkbox"/> Enable   Size: <input type="text" value="200"/> <input type="text" value="KB"/> Interval: <input type="checkbox"/> Enable <input type="text" value="1440"/> ( 1 ~ 10080 Minutes) Max Records: <input type="text" value="3000"/> (5~10000) <input type="button" value="Download log file"/> <input type="button" value="clear logs"/> Log type Category: <input checked="" type="checkbox"/> System <input checked="" type="checkbox"/> Attacks <input checked="" type="checkbox"/> Drop <input checked="" type="checkbox"/> Login message <input checked="" type="checkbox"/> Debug

### View & Email Log History

**View** button is provided for network administrator to view log history on the gateway. **Email Now** button enables administrator to send instant Email for analysis.

View & Email Log History		
Item	Value setting	Description
View button	N/A	Click the <b>View</b> button to view Log History in Web Log List Window.
Email Now button	N/A	Click the <b>Email Now</b> button to send Log History via Email instantly.

# 4G LTE M2M Router

Web Log List	
<input type="button" value="Previous"/> <input type="button" value="Next"/> <input type="button" value="First"/> <input type="button" value="Last"/> <input type="button" value="Download"/> <input type="button" value="Clear"/>	
Time	Log
Apr 1 06:01:36	dnsmasq-dhcp[6016]: Ignoring domain amit.com.tw for DHCP host name NB-msnb
Apr 1 06:08:31	dnsmasq-dhcp[6016]: Ignoring domain amit.com.tw for DHCP host name NB-msnb
Apr 1 06:15:30	dnsmasq-dhcp[6016]: Ignoring domain amit.com.tw for DHCP host name NB-msnb
Apr 1 06:22:06	dnsmasq-dhcp[6016]: Ignoring domain amit.com.tw for DHCP host name NB-msnb
Apr 1 06:28:42	dnsmasq-dhcp[6016]: Ignoring domain amit.com.tw for DHCP host name NB-msnb
Apr 1 06:35:42	dnsmasq-dhcp[6016]: Ignoring domain amit.com.tw for DHCP host name NB-msnb
Apr 1 06:42:20	dnsmasq-dhcp[6016]: Ignoring domain amit.com.tw for DHCP host name NB-msnb

Web Log List Window		
Item	Value Setting	Description
Time column	N/A	<b>It displays event time stamps</b>
Log column	N/A	<b>It displays Log messages</b>

Web Log List Button Description		
Item	Value setting	Description
Previous	N/A	Click the <b>Previous</b> button to move to the previous page.
Next	N/A	Click the <b>Next</b> button to move to the next page.
First	N/A	Click the <b>First</b> button to jump to the first page.
Last	N/A	Click the <b>Last</b> button to jump to the last page.
Download	N/A	Click the <b>Download</b> button to download log to your PC in tar file format.
Clear	N/A	Click the <b>Clear</b> button to clear all log.
Back	N/A	Click the <b>Back</b> button to return to the previous page.

## Web Log Type Category

Web Log Type Category screen allows network administrator to select the type of events to log and be displayed in the Web Log List Window as described in the previous section. Click on the View button to view Log History in the Web Log List window.

Web Log Type Category	<input checked="" type="checkbox"/> System <input checked="" type="checkbox"/> Attacks <input checked="" type="checkbox"/> Drop <input checked="" type="checkbox"/> Login message <input type="checkbox"/> Debug
-----------------------	--

Web Log Type Category Setting Window		
Item	Value Setting	Description
System	Checked by default	<b>Check to log system events and to display in the Web Log List window.</b>
Attacks	Checked by default	<b>Check to log attack events and to display in the Web Log List window.</b>
Drop	Checked by default	<b>Check to log packet drop events and to display in the Web Log List window.</b>

# 4G LTE M2M Router

Login message	Checked by default	Check to log system login events and to display in the Web Log List window.
Debug	Un-checked by default	Check to log debug events and to display in the Web Log List window.

## Email Alert

Email Alert screen allows network administrator to select the type of event to log and be sent to the destined Email account.

▶ Email Alert

Enable

Server: --- Option --- ▼ Add Object

E-mail Addresses:

Subject:

Log type Category:  System  Attacks  Drop  Login message  Debug

Email Alert Setting Window		
Item	Value Setting	Description
Enable	Un-checked by default	Check <b>Enable</b> box to enable sending event log messages to destined Email account defined in the E-mail Addresses blank space.
Server	N/A	Select one email server from the Server dropdown box to send Email. If none has been available, click the Add Object button to create an outgoing Email server. You may also add an outgoing Email server from Object Definition > External Server > External Server tab.
E-mail address	String : email format	Enter the recipient's Email address. Separate Email addresses with comma ',' or semicolon ';'.
Subject	String : any text	Enter the Email address in the format of ' <i>myemail@domain.com</i> '
Log type category	Default unchecked	Enter an Email subject that is easy for you to identify on the Email client.
		Select the type of events to log and be sent to the designated Email account. Available events are System, Attacks, Drop, Login message, and Debug.

# 4G LTE M2M Router

## Syslogd

Syslogd screen allows network administrator to select the type of event to log and be sent to the designated Syslog server.

Syslogd
  Enable Server: --- Option --- ▾

Log type Category:  System  Attacks  Drop  Login message  Debug

Syslogd Setting Window		
Item	Value Setting	Description
Enable	Un-checked by default	Check Enable box to activate the Syslogd function, and send event logs to a syslog server
Server	N/A	Select one syslog server from the Server dropdown box to sent event log to. If none has been available, click the Add Object button to create a system log server. You may also add an system log server from the Object Definition > External Server > External Server tab.
Log type category	Un-checked by default	Select the type of event to log and be sent to the destined syslog server. Available events are System, Attacks, Drop, Login message, and Debug.

## Log to Storage

Log to Storage screen allows network administrator to select the type of events to log and be stored at an internal or an external storage.

Log to Storage
  Enable

Select Device: Internal ▾

Log file name:

Split file:  Enable Size:  KB ▾

Interval:  Enable  ( 1 ~ 10080 Minutes)

Max Records:  (5~10000)

Log type Category:  System  Attacks  Drop  Login message  Debug

Log to Storage Setting Window		
Item	Value Setting	Description
Enable	Un-checked by default	Check to enable sending log to storage.
Select Device	Internal is selected by default	Select internal or external storage.
Log file name	Un-checked by default	Enter log file name to save logs in designated storage.
Split file Enable	Un-checked by default	Check enable box to split file whenever log file reaching the specified limit.
Split file Size	200 KB is set by default	Enter the file size limit for each split log file. <i>Value Range: 10 ~ 1000.</i>
Interval Enable	Un-checked by default	Check enable box to enable the log interval setting.
Log Interval	1440 is set by default	Enter the log interval setting. <i>Value Range: 1 ~ 10080 Minute.</i>

# 4G LTE M2M Router

Max Records	3000 is set by default	Enter the maximum number of records to be stored in the log storage. <i>Value Range: 5 ~ 10000.</i>
Log type category	Un-checked by default	Check which type of logs to send: System, Attacks, Drop, Login message, Debug

Log to Storage Button	Description	
Item	Value setting	Description
Download log file	N/A	Click the <b>Download log file</b> button to download log files to a log.tar file.
Clear Logs	N/A	Click the <b>Clear logs</b> button to delete the log files from the storage.

# 4G LTE M2M Router

## 6.2.5 Backup & Restore

In the Backup & Restore window, you can upgrade the device firmware when new firmware is available and also backup / restore the device configuration.

In addition to the factory default settings, you can also customize a special configuration setting as a customized default value. With this customized default value, you can reset the device to the expected default setting if needed.

Go to **Administration > System Operation > Backup & Restore** tab.

FW Backup & Restore	
Item	Setting
▶ FW Upgrade	Via Web UI ▾ FW Upgrade
▶ Backup Configuration Settings	Download ▾ Via Web UI
▶ Auto Restore Configuration	<input type="checkbox"/> Enable Save Conf. Clean Conf. Conf. Info.
▶ Self-defined Logo	Download ▾ Via Web UI Reset
▶ Self-defined CSS	Edit : Download ▾ Via Web UI Reset

FW Backup & Restore		
Item	Value Setting	Description
<b>FW Upgrade</b>	Via Web UI is selected by default	If new firmware is available, click the FW Upgrade button to upgrade the device firmware via Web UI, or Via Storage. After clicking on the “FW Upgrade” command button, you need to specify the file name of new firmware by using “Browse” button, and then click “Upgrade” button to start the FW upgrading process on this device. If you want to upgrade a firmware which is from GPL policy, please check “Accept unofficial firmware”
<b>Backup Configuration Settings</b>	Download is selected by default	You can backup or restore the device configuration settings by clicking the <i>Via Web UI</i> button. Download: for backup the device configuration to a config.bin file. Upload: for restore a designated configuration file to the device. Via Web UI: to retrieve the configuration file via Web GUI.
<b>Auto Restore Configuration</b>	The Enable box is unchecked by default	Click the Enable button to activate the customized default setting function. Once the function is activated, you can save the expected setting as a customized default setting by clicking the Save Conf. button, or clicking the Clean Conf. button to erase the stored customized configuration.

# 4G LTE M2M Router

# 4G LTE M2M Router

## 6.2.6 Reboot & Reset

For some special reason or situation, you may need to reboot the gateway or reset the device configuration to its default value. In addition to perform these operations through the Power ON/OFF, or pressing the reset button on the device panel, you can do it through the web GUI too.

Go to **Administration > System Operation > Reboot & Reset** tab.

In the Reboot & Reset window, you can reboot this device by clicking the “Reboot” button, and reset this device to default settings by clicking the “Reset” button.

System Operation	
Item	Setting
▶ Reboot	Now <input type="button" value="Reboot"/>
▶ Reset to Default	<input type="button" value="Reset"/>

System Operation Window		
Item	Value Setting	Description
<b>Reboot</b>	<b>Now</b> is selected by default	<b>Click the Reboot button to reboot the gateway immediately or on a pre-defined time schedule.</b> <b>Now: Reboot immediately</b> <b>Time Schedule: Select a pre-defined auto-reboot time schedule rule to reboot the auto device on a designated tim. To define a time schedule rule, go to Object Definition &gt; Scheduling &gt; Configuration tab.</b>
<b>Reset to Default</b>	N/A	<b>Click the Reset button to reset the device configuration to its default value.</b>

# 4G LTE M2M Router

## 6.3 FTP (not supported)

Not supported feature for the purchased product, leave it as blank.

# 4G LTE M2M Router

## 6.4 Diagnostic

This gateway supports simple network diagnosis tools for the administrator to troubleshoot and find the root cause of the abnormal behavior or traffics passing through the gateway. There can be a Packet Analyzer to help record the packets for a designated interface or specific source/destination host, and another Ping and Tracert tools for testing the network connectivity issues.

### 6.4.1 Diagnostic Tools

The Diagnostic Tools provide some frequently used network connectivity diagnostic tools (approaches) for the network administrator to check the device connectivity.

Go to **Administration > Diagnostic > Diagnostic Tools** tab.

Item	Setting
▶ Ping Test	Host IP: <input type="text"/> Outer Interface: <input type="text" value="Auto"/> LAN Source: <input type="text"/> <input type="text" value="Default"/> <input type="button" value="Ping"/>
▶ Tracert Test	Host IP: <input type="text"/> Interface: <input type="text" value="Auto"/> <input type="text" value="UDP"/> <input type="button" value="Tracert"/>
▶ Wake on LAN	<input type="text"/> <input type="button" value="Wake up"/>

Diagnostic Tools		
Item	Value setting	Description
<b>Ping Test</b>	Optional Setting	This allows you to specify an IP / FQDN, the Outer interface (auto, WAN, LAN, or VLAN), and LAN source (default, LAN, or VLAN) as well, so system will try to ping the specified device to test whether it is alive after clicking on the <b>Ping</b> button. A test result window will appear beneath it.
<b>Tracert Test</b>	Optional setting	Trace route (tracert) command is a network diagnostic tool for displaying the route (path) and measuring transit delays of packets across an IP network. Trace route proceeds until all (three) sent packets are lost for more than twice, then the connection is lost and the route cannot be evaluated. First, you need to specify an IP / FQDN, the test interface (LAN, WAN, or Auto) and the protocol (UDP or ICMP), and by default, it is <b>UDP</b> . Then, system will try to trace the specified host to test whether it is alive after clicking on <b>Tracert</b> button. A test result window will appear beneath it.
<b>Wake on LAN</b>	Optional setting	Wake on LAN (WOL) is an Ethernet networking standard that allows a computer to be turned on or awakened by a network message. You can specify the MAC address of the computer, in your LAN network, to be remotely turned on by clicking on the <b>Wake up</b> command button.
<b>Save</b>	N/A	Click the <b>Save</b> button to save the configuration.

# 4G LTE M2M Router

## 6.4.2 Packet Analyzer

The Packet Analyzer can capture packets depend on user settings. User can specify interfaces to capture packets and filter by setting rule. Ensure the log storage is available (either embedded SD-Card or external USB Storage), otherwise **Packet Analyzer** cannot be enabled.

Go to **Administration > Diagnostic > Packet Analyzer** tab.

Item	Setting
▶ Packet Analyzer	<input type="checkbox"/> Enable
▶ File Name	<input type="text"/>
▶ Split Files	<input type="checkbox"/> Enable File Size : <input type="text" value="200"/> <input type="text" value="KB"/>
▶ Packet Interfaces	<input type="checkbox"/> WAN-1 <input type="checkbox"/> WAN-2 <input type="checkbox"/> WAN-3 <input type="checkbox"/> WAN-4 <input type="checkbox"/> ASY <input type="text" value="Binary Mode"/>
	2.4G : <input type="checkbox"/> VAP-1 <input type="checkbox"/> VAP-2 <input type="checkbox"/> VAP-3 <input type="checkbox"/> VAP-4 <input type="checkbox"/> VAP-5 <input type="checkbox"/> VAP-6 <input type="checkbox"/> VAP-7 <input type="checkbox"/> VAP-8 5G : <input type="checkbox"/> VAP-1 <input type="checkbox"/> VAP-2 <input type="checkbox"/> VAP-3 <input type="checkbox"/> VAP-4 <input type="checkbox"/> VAP-5 <input type="checkbox"/> VAP-6 <input type="checkbox"/> VAP-7 <input type="checkbox"/> VAP-8

Configuration		
Item	Value setting	Description
<b>Packet Analyzer</b>	The box is unchecked by default.	Check <b>Enable</b> box to activate the Packet Analyzer function. If you cannot enable the checkbox, please check if the storage is available or not. Plug in the USB storage and then enable the Package Analyzer function.
<b>File Name</b>	1. An optional setting 2. Blank is set by default, and the default file name is <b>&lt;Interface&gt;_&lt;Date&gt;_&lt;index&gt;</b> .	Enter the file name to save the captured packets in log storage. If <b>Split Files</b> option is also enabled, the file name will be appended with an index code " <b>_&lt;index&gt;</b> ". The extension file name is <b>.pcap</b> .
<b>Split Files</b>	1. An optional setting 2. The default value of <b>File Size</b> is 200 KB.	Check <b>enable</b> box to split file whenever log file reaching the specified limit. If the <b>Split Files</b> option is enabled, you can further specify the <b>File Size</b> and <b>Unit</b> for the split files. <b>Value Range: 10 ~ 99999.</b> NOTE: <b>File Size</b> cannot be less than 10 KB
<b>Packet Interfaces</b>	An optional setting	Define the interface(s) that <b>Packet Analyzer</b> should work on. At least, one interface is required, but multiple selections are also accepted. The supported interfaces can be: <ul style="list-style-type: none"> <li>● <b>WAN</b>: When the WAN is enabled at <b>Physical Interface</b>, it can be selected here.</li> <li>● <b>ASY</b>: This means the serial communication interface. It is used to capture packets appearing in the <b>Field Communication</b>.</li> </ul>

# 4G LTE M2M Router

		Therefore, it can only be selected when specific field communication protocol, like Modbus, is enabled. Select <b>Binary mode</b> or <b>String mode</b> for the serial interface.
		<ul style="list-style-type: none"> <li>● <b>VAP</b>: This means the virtual AP. When WiFi and VAP are enabled, it can be selected here.</li> </ul>
<b>Save</b>	N/A	Click the <b>Save</b> button to save the configuration.
<b>Undo</b>	N/A	Click the <b>Undo</b> button to restore what you just configured back to the previous setting.

Once you enabled the Packet Analyzer function on specific Interface(s), you can further specify some filter rules to capture the packets which matched the rules.

☐ Capture Filters
⬆ ⬇ ✕

Item	Setting
▶ Filter	<input type="checkbox"/> Enable
▶ Source MACs	<div style="background-color: #f0f0f0; height: 30px; width: 100%;"></div>
▶ Source IPs	<div style="background-color: #f0f0f0; height: 30px; width: 100%;"></div>
▶ Source Ports	<div style="background-color: #f0f0f0; height: 30px; width: 100%;"></div>
▶ Destination MACs	<div style="background-color: #f0f0f0; height: 30px; width: 100%;"></div>
▶ Destination IPs	<div style="background-color: #f0f0f0; height: 30px; width: 100%;"></div>
▶ Destination Ports	<div style="background-color: #f0f0f0; height: 30px; width: 100%;"></div>

Capture Filters		
Item	Value setting	Description
<b>Filter</b>	Optional setting	Check <b>Enable</b> box to activate the Capture Filter function.
<b>Source MACs</b>	Optional setting	Define the filter rule with <b>Source MACs</b> , which means the source MAC address of packets. Packets which match the rule will be captured. Up to 10 MACs are supported, but they must be separated with “;”, e.g. AA:BB:CC:DD:EE:FF; 11:22:33:44:55:66 The packets will be captured when match any one MAC in the rule.
<b>Source IPs</b>	Optional setting	Define the filter rule with <b>Source IPs</b> , which means the source IP address of packets.

# 4G LTE M2M Router

		<p>Packets which match the rule will be captured.            Up to 10 IPs are supported, but they must be separated with “;”,            e.g. 192.168.1.1; 192.168.1.2            The packets will be captured when match any one IP in the rule.</p>
<b>Source Ports</b>	Optional setting	<p>Define the filter rule with <b>Source Ports</b>, which means the source port of packets.            The packets will be captured when match any port in the rule.            Up to 10 ports are supported, but they must be separated with “;”,            e.g. 80; 53  <b>Value Range: 1 ~ 65535.</b></p>
<b>Destination MACs</b>	Optional setting	<p>Define the filter rule with <b>Destination MACs</b>, which means the destination MAC address of packets.            Packets which match the rule will be captured.            Up to 10 MACs are supported, but they must be separated with “;”,            e.g. AA:BB:CC:DD:EE:FF; 11:22:33:44:55:66            The packets will be captured when match any one MAC in the rule.</p>
<b>Destination IPs</b>	Optional setting	<p>Define the filter rule with <b>Destination IPs</b>, which means the destination IP address of packets.            Packets which match the rule will be captured.            Up to 10 IPs are supported, but they must be separated with “;”,            e.g. 192.168.1.1; 192.168.1.2            The packets will be captured when match any one IP in the rule.</p>
<b>Destination Ports</b>	Optional setting	<p>Define the filter rule with <b>Destination Ports</b>, which means the destination port of packets.            The packets will be captured when match any port in the rule.            Up to 10 ports are supported, but they must be separated with “;”,            e.g. 80; 53  <b>Value Range: 1 ~ 65535.</b></p>

# 4G LTE M2M Router

## Chapter 7 Service

### 7.1 Cellular Toolkit

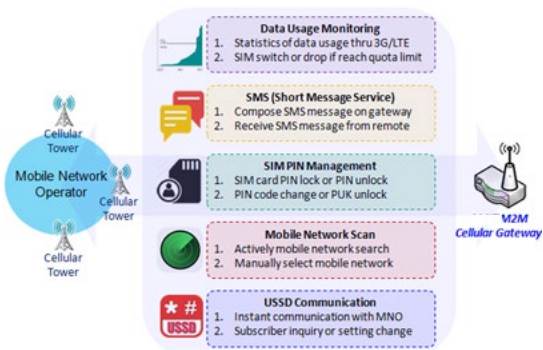

Besides cellular data connection, you may also like to monitor data usage of cellular WAN, sending text message through SMS, changing PIN code of SIM card, communicating with carrier/ISP by USSD command, or doing a cellular network scan for diagnostic purpose.

In Cellular Toolkit section, it includes several useful features that are related to cellular configuration or application. You can configure settings of Data Usage, SMS, SIM PIN, USSD, and Network Scan here. Please note at least a valid SIM card is required to be inserted to device before you continue settings in this section.

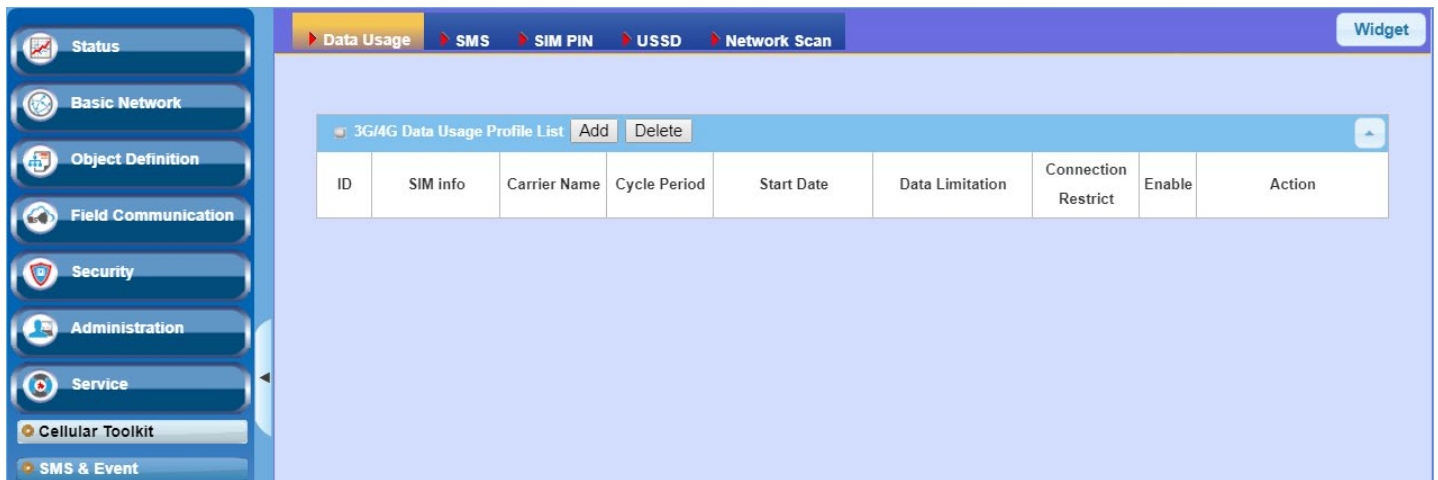

# 4G LTE M2M Router

## 7.1.1 Data Usage

Most of data plan for cellular connection is with a limited amount of data usage. If data usage has been over limited quota, either you will get much lower data throughput that may affect your daily operation, or you will get a 'bill shock' in the next month because carrier/ISP charges a lot for the over-quota data usage.

With help from Data Usage feature, device will monitor cellular data usage continuously and take actions. If data usage reaches limited quota, device can be set to drop the cellular data connection right away. Otherwise, if secondary SIM card is inserted, device will switch to secondary SIM and establish another cellular data connection with secondary SIM automatically.

If Data Usage feature is enabled, all history of cellular data usage can be viewed at **Status > Statistics & Reports > Cellular Usage** tab.

ID	SIM info	Carrier Name	Cycle Period	Start Date	Data Limitation	Connection Restrict	Enable	Action
1	3G/4G SIM A	ISP A	1 Monthly	Mon Apr 01 2019 00:00:00 GMT+0800	1GB	<input checked="" type="checkbox"/>	<input checked="" type="checkbox"/>	<input type="button" value="Edit"/> <input type="checkbox"/> Select

### 3G/4G Data Usage

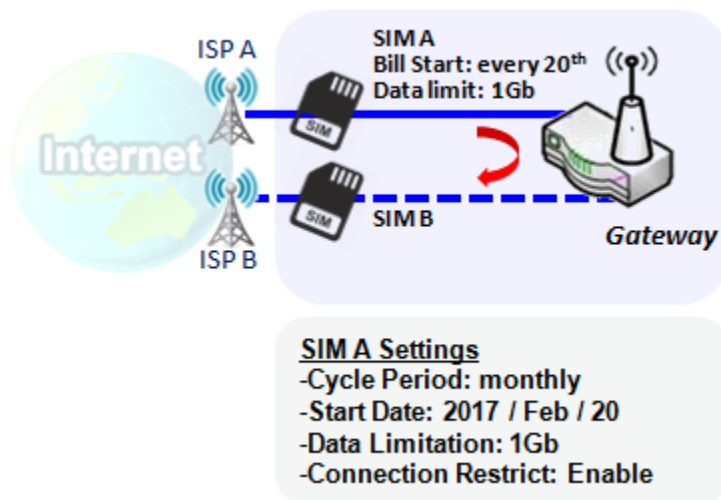

Data Usage feature enabling gateway device to continuously monitor cellular data usage and take actions. In the diagram, quota limit of SIM A is **1Gb** per month and bill start date is **20<sup>th</sup>** of every month. The device is smart to start a new calculation of data usage on every 20<sup>th</sup> of month. Enable Connection Restrict will force gateway device to drop cellular connection of SIM A when data usage reaches quota limit (1Gb in this case). If SIM failover feature is configured in **Internet Setup**, then gateway will switch to SIM B and establish a new cellular data connection automatically.

# 4G LTE M2M Router

## Data Usage Setting

Go to **Service** > **Cellular Toolkit** > **Data Usage** tab.

Before finished settings for Data Usage, you need to know bill start date, bill period, and quota limit of data usage according to your data plan. You can ask this information from your carrier or ISP.

## Create / Edit 3G/4G Data Usage Profile

3G/4G Data Usage Profile List <span>Add</span> <span>Delete</span>								
ID	SIM info	Carrier Name	Cycle Period	Start Date	Data Limitation	Connection Restrict	Enable	Action

When **Add** button is applied, 3G/4G Data Usage Profile Configuration screen will appear. You can create up to four data usage profiles, one profile for each SIM card used in the Gateway.

3G/4G Data Usage Profile Configuration	
Item	Setting
▶ SIM Select	3G/4G ▼ SIM A ▼
▶ Carrier Name	<input type="text"/>
▶ Cycle Period	Days ▼ <input type="text"/>
▶ Start Date	2019 ▼ / April ▼ / 1 ▼
▶ Data Limitation	<input type="text"/> KB ▼
▶ Connection Restrict	<input type="checkbox"/> Enable
▶ Enable	<input checked="" type="checkbox"/> Enable

3G/4G Data Usage Profile Configuration		
Item Setting	Value setting	Description
<b>SIM Select</b>	<b>3G/4G-1</b> and <b>SIM A</b> by default.	Choose a cellular interface ( <b>3G/4G-1</b> or <b>3G/4G-2</b> ), and a SIM card bound to the selected cellular interface to configure its data usage profile. <b>Note:</b> <b>3G/4G-2</b> is only available for for the product with dual cellular module.
<b>Carrier Name</b>	It is an optional item.	Fill in the Carrier Name for the selected SIM card for identification.
<b>Cycle Period</b>	<b>Days</b> by default	The first box has three types for cycle period. They are <b>Days</b> , <b>Weekly</b> and <b>Monthly</b> . <b>Days:</b> For per Days cycle periods, you have to further specify the number of days in the second box. <b>Value Range:</b> 1 ~ 90 days. <b>Weekly, Monthly:</b> The cycle period is one week or one month.
<b>Start Date</b>	N/A	Specify the date to start measure network traffic. Please don't select the day before now, otherwise, the traffic statistics will be incorrect.
<b>Data Limitation</b>	N/A	Specify the allowable data limitation for the defined cycle period.

# 4G LTE M2M Router

<b>Connection Restrict</b>	Un-Checked by default.	Check the <b>Enable</b> box to activate the connection restriction function. During the specified cycle period, if the actual data usage exceeds the allowable data limitation, the cellular connection will be forced to disconnect.
<b>Enable</b>	Un-Checked by default.	Check the <b>Enable</b> box to activate the data usage profile.

# 4G LTE M2M Router

## 7.1.2 SMS

Short Message Service (SMS) is a text messaging service, which is used to be widely-used on mobile phones. It uses standardized communications protocols to allow mobile phones or cellular devices to exchange short text messages in an instant and convenient way.

### SMS Setting

Go to **Service > Cellular Toolkit > SMS** tab

With this gateway device, you can send SMS text messages or browse received SMS messages as you usually do on a cellular phone.

### Setup SMS Configuration

Item	Setting
Physical Interface	3G/4G-1 ▾
SMS	<input type="checkbox"/> Enable SIM Status: SIM_A
SMS Storage	SIM Card Only ▾
SMS Space	<input type="checkbox"/> Enable & Keep Available Space <input type="text" value=""/> (1-10)

Configuration Item	Value setting	Description
<b>Physical Interface</b>	The box is <b>3G/4G-1</b> by default	Choose a cellular interface ( <b>3G/4G-1</b> or <b>3G/4G-2</b> ) for the following SMS function configuration. <b>Note:</b> <b>3G/4G-2</b> is only available for for the product with dual cellular module.
<b>SMS</b>	The box is checked by default	This is the SMS switch. If the box checked that the SMS function enable, if the box unchecked that the SMS function disable.
<b>SIM Status</b>	N/A	Depend on currently SIM status. The possible value will be <b>SIM_A</b> or <b>SIM_B</b> .
<b>SMS Storage</b>	The box is <b>SIM Card Only</b> by default	This is the SMS storage location. Currently the option only <b>SIM Card Only</b> .
<b>SMS Space</b>	The box is unchecked by default	Check the <b>Enable</b> box and specify a number (1-10) for message count to reserve some available storage space and prevent it from run out of storage. The oldest message(s) will be deleted when the SMS storage is going to full.
<b>Save</b>	N/A	Click the <b>Save</b> button to save the settings

# 4G LTE M2M Router

## SMS Summary

Show **Unread SMS**, **Received SMS**, **Sent SMS**, **Remaining SMS**, and edit SMS context to send, read SMS from SIM card.

Item	Setting
▶ Unread SMS	0
▶ Received SMS	10
▶ Sent SMS	0
▶ Remaining SMS	0

SMS Summary		
Item	Value setting	Description
<b>Unread SMS</b>	N/A	If SIM card insert to router first time, unread SMS value is zero. When received the new SMS but didn't read, this value plus one.
<b>Received SMS</b>	N/A	This value record the existing SMS numbers from SIM card, When received the new SMS, this value plus one.
<b>Sent SMS</b>	N/A	This value record the number of out going SMS, When sent one SMS, this value plus one.
<b>Remaining SMS</b>	N/A	This value is SMS capacity minus received SMS, When received the new SMS, this value minus one.
<b>New SMS</b>	N/A	Click <b>New SMS</b> button, a <b>New SMS</b> screen appears. User can set the SMS setting from this screen. Refer to New SMS in the next page.
<b>SMS Inbox</b>	N/A	Click <b>SMS Inbox</b> button, a <b>SMS Inbox List</b> screen appears. User can read or delete SMS, reply SMS or forward SMS from this screen. Refer to SMS Inbox List in the next page.
<b>Refresh</b>	N/A	Click the <b>Refresh</b> button to update the SMS summary immediately.

# 4G LTE M2M Router

## New SMS

You can set the SMS setting from this screen.

Item	Setting
Receivers	<input type="text"/> (Use '+' for International Format and ';' to Compose Multiple Receivers)
Text Message	<div style="border: 1px solid #ccc; height: 100px;"></div> Length of Current Input : 0
Result	

New SMS		
Item	Value setting	Description
Receivers	N/A	Write the receivers to send SMS. User need to add the semicolon and compose multiple receivers that can group send SMS.
Text Message	N/A	Write the SMS context to send SMS. The router supports up to a maximum of 1023 character for SMS context length.
Send	N/A	Click the <b>Send</b> button, above text message will be sent as a SMS.
Result	N/A	If SMS has been sent successfully, it will show <b>Send OK</b> , otherwise <b>Send Failed</b> will be displayed.

## SMS Inbox List

You can read or delete SMS, reply SMS or forward SMS from this screen.

ID	From Phone Number	Timestamp	SMS Text Preview	Actions

SMS Inbox List		
Item	Value setting	Description
ID	N/A	The number of SMS.
From Phone Number	N/A	Sender List (Phone Number) for the received SMS
Timestamp	N/A	What time the SMS is received
SMS Text Preview	N/A	Preview the SMS text. Click the <b>Detail</b> button to read a certain message.

# 4G LTE M2M Router

<b>Action</b>	The box is unchecked by default	Click the <b>Detail</b> button to read the SMS detail; Click the <b>Reply / Forward</b> button to reply/forward SMS. Besides, you can check the box(es), and then click the <b>Delete</b> button to delete the checked SMS(s).
<b>Refresh</b>	N/A	Refresh the SMS Inbox List.
<b>Delete</b>	N/A	Delete the SMS for all checked box from Action.
<b>Close</b>	N/A	Close the Detail SMS Message screen.

## SMS Sent Folder

You can read or delete SMS from this screen.

SMS Sent Folder					Delete	Close	Previous	0 ▼	Next	
ID	Receivers	Timestamp	SMS Text Preview	Actions						

SMS Sent Folder		
Item	Value setting	Description
<b>ID</b>	N/A	The number of SMS.
<b>Receivers</b>	N/A	Receiver list for the sent SMS.
<b>Timestamp</b>	N/A	What time the SMS is sent
<b>SMS Text Preview</b>	N/A	Preview the SMS text. Click the <b>Detail</b> button to read a certain message.
<b>Action</b>	The box is unchecked by default	Click the <b>Detail</b> button to read the SMS detail Besides, you can check the box(es), and then click the <b>Delete</b> button to delete the checked record(s).
<b>Refresh</b>	N/A	Refresh the SMS Sent Folder.
<b>Delete</b>	N/A	Delete the SMS for all checked box from Action.
<b>Close</b>	N/A	Close the Detail SMS Message screen.

# 4G LTE M2M Router

## 7.1.3 SIM PIN

With most cases in the world, users need to insert a SIM card (a.k.a. UICC) into end devices to get on cellular network for voice service or data surfing. The SIM card is usually released by mobile operators or service providers. Each SIM card has a unique number (so-called ICCID) for network owners or service providers to identify each subscriber. As SIM card plays an important role between service providers and subscribers, some security mechanisms are required on SIM card to prevent any unauthorized access.

Enabling a PIN code in SIM card is an easy and effective way of protecting cellular devices from unauthorized access. This gateway device allows you to activate and manage PIN code on a SIM card through its web GUI.

### Activate PIN code on SIM Card

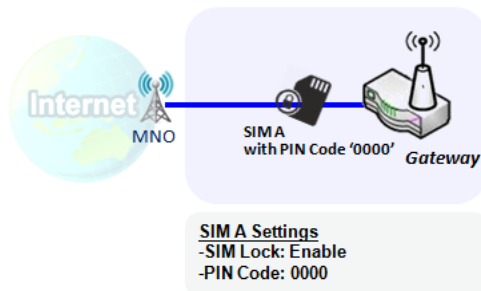

This gateway device allows you to activate PIN code on SIM card. This example shows how to activate PIN code on SIM-A for 3G/4G-1 with default PIN code “0000”.

### Change PIN code on SIM Card

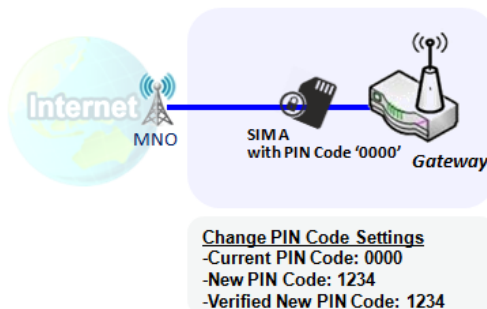

This gateway device allows you to change PIN code on SIM card. Following the example above, you need to type original PIN code “0000”, and then type new PIN code with ‘1234’ if you like to set new PIN code as ‘1234’. To confirm the new PIN code you type is what you want, you need to type new PIN code ‘1234’ in Verified New PIN Code again.

### Unlock SIM card by PUK Code

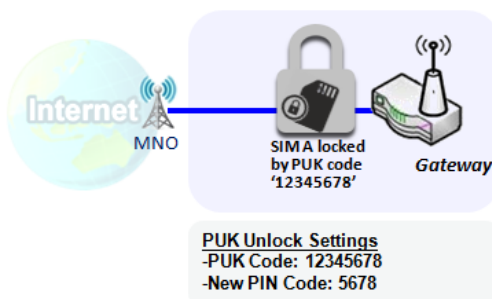

If you entered incorrect PIN code at configuration page for 3G/4G-1 WAN over three times, and then it will cause SIM card to be locked by PUK code. Then you have to call service number to get a PUK code to unlock SIM card. In the diagram, the PUK code is “12345678” and new PIN code is “5678”.

# 4G LTE M2M Router

## SIM PIN Setting

Go to **Service > Cellular Toolkit > SIM PIN** Tab

With the SIM PIN Function window, it allows you to enable or disable SIM lock (which means protected by PIN code), or change PIN code. You can also see the information of remaining times of failure trials as we mentioned earlier. If you run out of these failure trials, you need to get a PUK code to unlock SIM card.

### Select a SIM Card

Configuration	
Item	Setting
▶ Physical Interface	3G/4G-1 ▼
▶ SIM Status	SIM-A Ready
▶ SIM Selection	SIM-A ▼ <input type="button" value="Switch"/>

Configuration Window		
Item	Value setting	Description
<b>Physical Interface</b>	The box is <b>3G/4G-1</b> by default	Choose a cellular interface ( <b>3G/4G-1</b> or <b>3G/4G-2</b> ) to change the SIM PIN setting for the selected SIM Card. <b>Note: 3G/4G-2</b> is only available for for the product with dual cellular module.
<b>SIM Status</b>	N/A	Indication for the selected SIM card and the SIM card status. The status could be <b>Ready</b> , <b>Not Insert</b> , or <b>SIM PIN</b> . <b>Ready</b> -- SIM card is inserted and ready to use. It can be a SIM card without PIN protection or that SIM card is already unlocked by correct PIN code. <b>Not Insert</b> -- No SIM card is inserted in that SIM slot. <b>SIM PIN</b> -- SIM card is protected by PIN code, and it's not unlocked by a correct PIN code yet. That SIM card is still at locked status.
<b>SIM Selection</b>	N/A	Select the SIM card for further SIM PIN configuration. Press the <b>Switch</b> button, then the Gateway will switch SIM card to another one. After that, you can configure the SIM card.

# 4G LTE M2M Router

## Enable / Change PIN Code

Enable or Disable PIN code (password) function, and even change PIN code function.

Item	Setting
▶ PIN Lock	<input checked="" type="checkbox"/> Enable PIN Code: <input type="text"/> (4~8 digits)
▶ Remaining times	N/A

SIM function Window		
Item Setting	Value setting	Description
<b>SIM lock</b>	Depend on SIM card	Click the <b>Enable</b> button to activate the SIM lock function. For the first time you want to enable the SIM lock function, you have to fill in the PIN code as well, and then click <b>Save</b> button to apply the setting.
<b>Remaining times</b>	Depend on SIM card	Represent the remaining trial times for the SIM PIN unlocking.
<b>Save</b>	N/A	Click the <b>Save</b> button to apply the setting.
<b>Change PIN Code</b>	N/A	Click the <b>Change PIN code</b> button to change the PIN code (password). If the <b>SIM Lock</b> function is not enabled, the <b>Change PIN code</b> button is disabled. In the case, if you still want to change the PIN code, you have to enable the SIM Lock function first, fill in the PIN code, and then click the <b>Save</b> button to enable. After that, You can click the <b>Change PIN code</b> button to change the PIN code.

When **Change PIN Code** button is clicked, the following screen will appear.

Item	Setting
▶ Current PIN Code	<input type="text"/> (4~8 digits)
▶ New PIN Code	<input type="text"/> (4~8 digits)
▶ Verified New PIN Code	<input type="text"/> (4~8 digits)

Item	Value Setting	Description
<b>Current PIN Code</b>	A Must filled setting	Fill in the current (old) PIN code of the SIM card.
<b>New PIN Code</b>	A Must filled setting	Fill in the new PIN Code you want to change.
<b>Verified New PIN Code</b>	A Must filled setting	Confirm the new PIN Code again.
<b>Apply</b>	N/A	Click the <b>Apply</b> button to change the PIN code with specified new PIN code.
<b>Cancel</b>	N/A	Click the <b>Cancel</b> button to cancel the changes and keep current PIN code.

**Note:** If you changed the PIN code for a certain SIM card, you must also change the corresponding PIN code specified in the **Basic Network > WAN & Uplink > Internet Setup > Connection with SIM Card** page.

# 4G LTE M2M Router

Otherwise, it may result in wrong SIM PIN trials with invalid (old) PIN code.

## Unlock with a PUK Code

The PUK Function window is only available for configuration if that SIM card is locked by PUK code. It means that SIM card is locked and needs additional PUK code to unlock. Usually it happens after too many trials of incorrect PIN code, and the remaining times in SIM Function table turns to 0. In this situation, you need to contact your service provider and request a PUK code for your SIM card, and try to unlock the locked SIM card with the provided PUK code. After unlocking a SIM card by PUK code successfully, the SIM lock function will be activated automatically.

Item	Setting
▶ PUK status	PUK unlock.
▶ Remaining times	N/A
▶ PUK Code	<input type="text"/> (8 digits)
▶ New PIN Code	<input type="text"/> (4~8 digits)

Item	Value setting	Description
<b>PUK status</b>	<b>PUK Unlock / PUK Lock</b>	Indication for the PUK status. The status could be <b>PUK Lock</b> or <b>PUK Unlock</b> . As mentioned earlier, the SIM card will be locked by PUK code after too many trials of failure PIN code. In this case, the PUK Status will turn to <b>PUK Lock</b> . In a normal situation, it will display <b>PUK Unlock</b> .
<b>Remaining times</b>	Depend on SIM card	Represent the remaining trial times for the PUK unlocking. Note : <b>DO NOT make the remaining times down to zero, it will damage the SIM card FOREVER !</b> Call for your ISP's help to get a correct PUK and unlock the SIM if you don't have the PUK code.
<b>PUK Code</b>	A Must filled setting	Fill in the PUK code (8 digits) that can unlock the SIM card in PUK unlock status.
<b>New PIN Code</b>	A Must filled setting	Fill in the New PIN Code (4~8 digits) for the SIM card. You have to determine your new PIN code to replace the old, forgotten one. Keep the PIN code (password) in mind with care.
<b>Save</b>	N/A	Click the <b>Save</b> button to apply the setting.

**Note:** If you changed the PUK code and PIN code for a certain SIM card, you must also change the corresponding PIN code specified in the **Basic Network > WAN & Uplink > Internet Setup > Connection with SIM Card** page. Otherwise, it may result in wrong SIM PIN trials with invalid (old) PIN code.

# 4G LTE M2M Router

## 7.1.4 USSD

Unstructured Supplementary Service Data (USSD) is a protocol used by GSM cellular telephones to communicate with the service provider's computers. USSD can be used for WAP browsing, prepaid callback service, mobile-money services, location-based content services, menu-based information services, and as part of configuring the phone on the network.

An USSD message is up to 182 alphanumeric characters in length. Unlike Short Message Service (SMS) messages, USSD messages create a real-time connection during an USSD session. The connection remains open, allowing a two-way exchange of a sequence of data. This makes USSD more responsive than services that use SMS.

Configuration	
Item	Setting
Physical Interface	3G/4G-1 ▼ SIM Status: SIM_A

  

USSD Profile List				
ID	Profile Name	USSD Command	Comments	Actions

USSD Request	
Item	Setting
USSD Profile	--- Option --- ▼
USSD Command	<input type="text"/>

### USSD Scenario

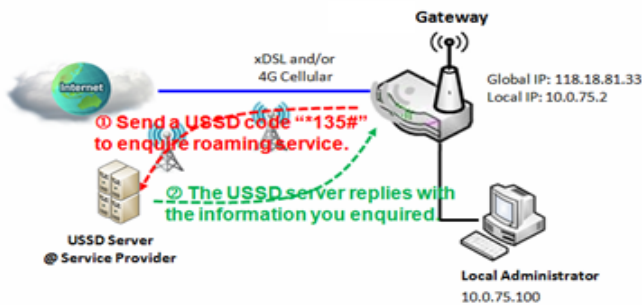

USSD allows you to have an instant bi-directional communication with carrier/ISP. In the diagram, the USSD command '\*135#' is referred to data roaming services. After sending that USSD command to carrier, you can get a response at window USSD Response. Please note the USSD command varies for different carriers/ISP.

# 4G LTE M2M Router

## USSD Setting

Go to **Service** > **Cellular Toolkit** > **USSD** tab.

In "USSD" page, there are four windows for the USSD function. The "Configuration" window can let you specify which 3G/4G module (physical interface) is used for the USSD function, and system will show which SIM card in the module is the current used one. The second window is the "USSD Profile List" and it shows all your defined USSD profiles that store pre-commands for activating an USSD session. An "Add" button in the window can let you add one new USSD profile and define the command for the profile in the third window, the "USSD Profile Configuration". When you want to start the activation of an USSD connection session to the USSD server, select the USSD profile or type in the correct pre-command, and then click on the "Send" button for the session. The responses from the USSD server will be displayed beneath the "USSD Command" line. When commands typed in the "USSD Command" field are sent, received responses will be displayed in the "USSD Response" blank space. User can communicate with the USSD server by sending USSD commands and getting USSD responses via the gateway.

## USSD Configuration

Configuration	
Item	Setting
▶ Physical Interface	3G/4G-1 ▼ SIM Status: SIM_A

Configuration Item	Value setting	Description
<b>Physical Interface</b>	The box is <b>3G/4G-1</b> by default.	Choose a cellular interface ( <b>3G/4G-1</b> or <b>3G/4G-2</b> ) to configure the USSD setting for the connected cellular service (identified with <b>SIM_A</b> or <b>SIM_B</b> ). <b>Note: 3G/4G-2</b> is only available for for the product with dual cellular module.
<b>SIM Status</b>	N/A	Show the connected cellular service (identified with <b>SIM_A</b> or <b>SIM_B</b> ).

## Create / Edit USSD Profile

The cellular gateway allows you to custom your USSD profile. It supports up to a maximum of 35 USSD profiles.

USSD Profile List				
ID	Profile Name	USSD Command	Comments	Actions

# 4G LTE M2M Router

When **Add** button is applied, **USSD Profile Configuration** screen will appear.



The screenshot shows a mobile application interface titled "USSD Request". At the top, there are three buttons: "Send", "Clear", and "Cancel". Below the buttons is a table with two columns: "Item" and "Setting". The "USSD Profile" row has a dropdown menu with the text "--- Option ---". The "USSD Command" row has an empty text input field.

USSD Profile Configuration		
Item	Value setting	Description
Profile Name	N/A	Enter a name for the USSD profile.
USSD Command	N/A	Enter the USSD command defined for the profile. Normally, it is a command string composed with numeric keypad "0~9", "*", and "#". The USSD commands are highly related to the cellular service, please check with your service provider for the details.
Comments	N/A	Enter a brief comment for the profile.

## Send USSD Request

When **send** the USSD command, the USSD Response screen will appear.

When click the **Clear** button, the USSD Response will disappear.



This screenshot is identical to the one above, showing the "USSD Request" screen with "Send", "Clear", and "Cancel" buttons, and a table for configuring the USSD Profile and Command.

USSD Request		
Item	Value setting	Description
USSD Profile	N/A	Select a USSD profile name from the dropdown list.
USSD Command	N/A	The USSD Command string of the selected profile will be shown here.
USSD Response	N/A	Click the <b>Send</b> button to send the USSD command, and the <b>USSD Response</b> screen will appear. You will see the response message of the corresponding service, receive the service SMS.

# 4G LTE M2M Router

## 7.1.5 Network Scan

"Network Scan" function can let administrator specify the device how to connect to the mobile system for data communication in each 3G/4G interface. For example, administrator can specify which generation of mobile system is used for connection, 2G, 3G or LTE. Moreover, he can define their connection sequence for the gateway device to connect to the mobile system automatically. Administrator also can scan the mobile systems in the air manually, select the target operator system and apply it. The manual scanning approach is used for problem diagnosis.

### Network Scan Setting

Go to **Service > Cellular Toolkit > Network Scan** tab.

In "Network Scan" page, there are two windows for the Network Scan function. The "Configuration" window can let you select which 3G/4G module (physical interface) is used to perform Network Scan, and system will show the current used SIM card in the module. You can configure each 3G/4G WAN interface by executing the network scanning one after another. You can also specify the connection sequence of the targeted generation of mobile system, 2G/3G/LTE.

### Network Scan Configuration

Configuration	
Item	Setting
▶ Physical Interface	3G/4G-1 ▼ SIM Status: SIM_A
▶ Network Type	LTE Only ▼
▶ Scan Approach	Auto ▼

Configuration Item	Value setting	Description
<b>Physical Interface</b>	The box is <b>3G/4G-1</b> by default	Choose a cellular interface ( <b>3G/4G-1</b> or <b>3G/4G-2</b> ) for the network scan function. <b>Note: 3G/4G-2</b> is only available for for the product with dual cellular module.
<b>SIM Status</b>	N/A	Show the connected cellular service (identified with <b>SIM_A</b> or <b>SIM_B</b> ).
<b>Network Type</b>	<b>Auto</b> is selected by default.	Specify the network type for the network scan function. It can be Auto, 2G Only, 2G prefer, 3G Only, 3G prefer, or LTE Only. When <b>Auto</b> is selected, the network will be register automatically; If the <b>prefer</b> option is selected, network will be register for your option first; If the <b>only</b> option is selected, network will be register for your option only.
<b>Scan Approach</b>	<b>Auto</b> is selected by default.	When <b>Auto</b> selected, cellular module register automatically. If the <b>Manually</b> option is selected, a <b>Network Provider List</b> screen appears. Press <b>Scan</b> button to scan for the nearest base stations. Select (check the box) the preferred base stations then click <b>Apply</b> button to apply settings.

# 4G LTE M2M Router

**Save** N/A Click **Save** to save the settings

The second window is the "Network Provider List" window and it appears when the **Manually** Scan Approach is selected in the Configuration window. By clicking on the "Scan" button and wait for 1 to 3 minutes, the found mobile operator system will be displayed for you to choose. Click again on the "Apply" button to drive system to connect to that mobile operator system for the dedicated 3G/4G interface.

Network Provider List <input type="button" value="Scan"/> <input type="button" value="Apply"/>			
Provider Name	Mobile System	Network Status	Action

# 4G LTE M2M Router

## 7.2 SMS & Event

SMS & Event handling is the application that allows administrator to setup the pre-defined events, handlers, or response behavior with individual profiles. With properly configuring the event handling function, administrator can easily and remotely obtain the status and information via the purchased gateway.

The supported events are categorized into two groups: the **managing events** and **notifying events**.

The **managing events** are the events that are used to manage the gateway or change the setting / status of the specific functionality of the gateway. On receiving the managing event, the gateway will take action to change the functionality, and collect the required status for administration simultaneously.

The **notifying events** are the events that some related objects have been triggered and take corresponding actions on the occurrence of the events. It could be an event for alerting the administrator something happened with SMS message, Email, and SNMP Trap, etc...

For ease of configuration, administrator can create and edit the common pre-defined managing / notifying event profiles for taking instant reaction on a certain event or managing the devices for some advanced useful purposes. For example, sending/receiving remote managing SMS for the gateway's routine maintaining, and so on. All of such management and notification function can be realized effectively via the Event Handling feature.

The following is the summary lists for the provided profiles, and events:

- Profiles (Rules):
  - SMS Configuration and Accounts
  - Email Accounts
  - Remote Host profiles
- Managing Events:
  - Trigger Type: SMS, SNMP Trap
  - Actions: Get the Network Status; or Configure the LAN/VLAN behavior, WIFI behavior, NAT behavior, Firewall behavior, VPN behavior, System Management, Administration, and Remote Host.
- Notifying Events:
  - Trigger Type: Connection Change (WAN, LAN & VLAN, WiFi, DDNS), Administration, Data Usage.
  - Actions: Notify the administrator with SMS, Syslog, SNMP Trap or Email Alert; Sending collected information to Remote Host.

To use the event handling function, First of all, you have to enable the event management setting and configure the event details with the provided profile settings. You can create or edit pre-defined profiles for individual managing / notifying events. The profile settings are separated into several items; they are the SMS Account Definition, Email Service Definition, and Remote Host Configuration. Then, you have to configure each managing / notifying event with identifying the event's trigger condition, and the corresponding actions (reaction for the event) for the event. For each event, more than one action can be activated simultaneously.

# 4G LTE M2M Router

## 7.2.1 Configuration

Go to **Service > SMS & Event > Configuration** Tab.

Event handling is the service that allows administrator to setup the pre-defined events, handlers, or response behavior with individual profiles.

### Enable Event Management

Configuration	
Item	Setting
▶ Event Management	<input type="checkbox"/> Enable

Item	Value setting	Description
<b>Event Management</b>	The box is unchecked by default	Check the <b>Enable</b> box to activate the Event Management function.

### Enable SMS Management

To use the SMS management function, you have to configure some important settings first.

SMS Configuration	
Item	Setting
▶ Message Prefix	<input type="checkbox"/> Enable <input type="text"/>
▶ Physical Interface	3G/4G-1 ▼ SIM Status: SIM_A
▶ Delete Managed SMS after Processing	<input type="checkbox"/> Enable

Item	Value setting	Description
<b>Message Prefix</b>	The box is unchecked by default	Click the <b>Enable</b> box to enable the SMS prefix for validating the received SMS. Once the function is enabled, you have to enter the prefix behind the checkbox. The received managing events SMS must have the designated prefix as an initial identifier, then corresponding handlers will become effective for further processing.

# 4G LTE M2M Router

<b>Physical Interface</b>	The box is 3G/4G-1 by default.	Choose a cellular interface ( <b>3G/4G-1</b> or <b>3G/4G-2</b> ) to configure the SMS management setting. <b>Note: 3G/4G-2</b> is only available for for the product with dual cellular module.
<b>SIM Status</b>	N/A	Show the connected cellular service (identified with <b>SIM_A</b> or <b>SIM_B</b> ).
<b>Delete Managed SMS after Processing</b>	The box is unchecked by default	Check the <b>Enable</b> box to delete the received managing event SMS after it has been processed.

## Create / Edit SMS Account

Setup the SMS Account for managing the gateway through the SMS. It supports up to a maximum of 5 accounts.

ID	Phone Number	Phone Description	Application	Send confirmed SMS	Enable	Actions
----	--------------	-------------------	-------------	--------------------	--------	---------

You can click the **Add / Edit** button to configure the SMS account.

Item	Setting
▶ Phone Number	Specific Number ▾ <input type="text"/>
▶ Phone Description	<input type="text"/>
▶ Application	<input type="checkbox"/> Event Trigger <input type="checkbox"/> Notify Handle
▶ Send confirmed SMS	<input type="checkbox"/> Enable
▶ Enable	<input checked="" type="checkbox"/> Enable

Item	Value setting	Description
<b>Phone Number</b>	1. Mobile phone number format 2. A Must filled setting	Select the Phone number policy from the drop list, and specify a mobile phone number as the SMS account identifier if required. It can be <b>Specific Number</b> , or <b>Allow Any</b> . If <b>Specific Number</b> is selected, you have to specify the phone number as the SMS account identifier. <b>Value Range:</b> -1 ~ 32 digits.
<b>Phone Description</b>	1. Any text 2. An Optional setting	Specify a brief description for the SMS account.
<b>Application</b>	A Must filled setting	Specify the application type. It could be <b>Event Trigger</b> , <b>Notify Handle</b> , or <b>both</b> . If the Phone Number policy is <b>Allow Any</b> , the Noftify Handle will be unavailable.
<b>Send confirmed SMS</b>	1. An Optional setting 2. The box is unchecked by default.	Click <b>Enable</b> box to active the SMS response function. The gateway will send a confirmed message back to the sender whenever it received a SMS managing event. The confirmed message is similar to following

# 4G LTE M2M Router

		format: "Device received a SMS with command xxxxx."
<b>Enable</b>	The box is unchecked by default.	Click <b>Enable</b> box to activate this account.
<b>Save</b>	NA	Click the <b>Save</b> button to save the configuration.

## Create / Edit Email Service Account

Setup the Email Service Account for event notification. It supports up to a maximum of 5 accounts.

Email Service List				
ID	Email Server	Email Addresses	Enable	Actions

You can click the **Add / Edit** button to configure the Email account.

Email Service Configuration	
Item	Setting
▶ Email Server	--- Option --- ▼
▶ Email Addresses	<input type="text"/>
▶ Enable	<input checked="" type="checkbox"/> Enable
<input type="button" value="Save"/>	

Email Service Configuration		
Item	Value setting	Description
<b>Email Server</b>	--- Option ---	Select an Email Server profile from <b>External Server</b> setting for the email account setting.
<b>Email Addresses</b>	1. Internet E-mail address format 2. A Must filled setting	Specify the Destination Email Addresses.
<b>Enable</b>	The box is unchecked by default.	Click <b>Enable</b> box to activate this account.
<b>Save</b>	NA	Click the <b>Save</b> button to save the configuration

# 4G LTE M2M Router

## Create / Edit Remote Host Profile

Setup the Remote Host Profile. It supports up to a maximum of 10 profiles.

Remote Host List								Add	Delete
ID	Host Name	Host IP	Protocol Type	Port Number	Prefix Message	Suffix Message	Enable	Actions	

You can click the **Add / Edit** button to configure the profile.

Remote Host Configuration	
Item	Setting
▶ Host Name	<input type="text"/>
▶ Host IP	<input type="text"/>
▶ Protocol Type	TCP ▼
▶ Port Number	<input type="text"/>
▶ Prefix Message	<input type="text"/>
▶ Suffix Message	<input type="text"/>
▶ Enable	<input type="checkbox"/>
Save	

Remote Host Configuration		
Item	Value setting	Description
<b>Host Name</b>	1. String format 2. A Must filled setting	Specify the Remote Host profile name. <b>Value Range:</b> -1 ~ 64 characters.
<b>Host IP</b>	1. A Must filled setting 2. IP Address format.	Specify the IP address for the Remote Host. IPv4 Format.
<b>Protocol Type</b>	1. A Must filled setting 2. <b>TCP</b> is selected by default	Specify the protocol to access the Remote Host. It could be <b>TCP</b> or <b>UDP</b> .
<b>Port Number</b>	1. A Must filled setting	Specify the Port number for accessing the Remote Host. <b>Value Range:</b> 1 ~ 65535.
<b>Prefix Message</b>	1. String format 2. An Optional filled setting	Specify the Prefix Message string as pre-defined identification for accessing the remote host, if required. <b>Value Range:</b> -1 ~ 64 characters.
<b>Suffix Message</b>	1. String format 2. An Optional filled setting	Specify the Suffix Message string as pre-defined identification for accessing the remote host, if required. <b>Value Range:</b> -1 ~ 64 characters.
<b>Enable</b>	The box is unchecked by default.	Click <b>Enable</b> box to activate this profile setting.
<b>Save</b>	NA	Click the <b>Save</b> button to save the configuration
<b>Undo</b>	NA	Click the <b>Undo</b> button to restore what you just configured back to the previous setting.

# 4G LTE M2M Router

## 7.2.2 Managing Events

Managing Events allow administrator to define the relationship (rule) among event trigger, handlers and response.

Go to **Service > SMS & Event > Managing Events** Tab.

### Enable Managing Events

Configuration	
Item	Setting
Managing Events	<input type="checkbox"/> Enable

Configuration		
Item	Value setting	Description
Managing Events	The box is unchecked by default	Check the <b>Enable</b> box to activate the Managing Events function.

### Create / Edit Managing Event Rules

Setup the Managing Event rules. It supports up to a maximum of 128 rules.

Managing Event List							Add	Delete
ID	Event Name	Event	Trigger Type	Description	Enable	Actions		

When **Add** or **Edit** button is applied, the **Managing Event Configuration** screen will appear.

# 4G LTE M2M Router

Managing Event Configuration	
Item	Setting
▶ Event Name	<input type="text"/>
▶ Event	<input type="text" value="None"/> <input type="text" value="None"/> <input type="text" value="None"/>
▶ Trigger Type	<input type="text" value="Period"/>
▶ Interval	<input type="text" value="0"/> (0~86400 seconds)
▶ Description	<input type="text"/>
▶ Action	<input type="checkbox"/> Network Status <input type="checkbox"/> WAN <input type="checkbox"/> LAN&VLAN <input type="checkbox"/> WiFi <input type="checkbox"/> NAT <input type="checkbox"/> Firewall <input type="checkbox"/> VPN <input type="checkbox"/> GRE <input type="checkbox"/> System Manage <input type="checkbox"/> Administration <input type="checkbox"/> Digital Output <input type="checkbox"/> Remote Host
▶ Managing Event	<input checked="" type="checkbox"/> Enable

Managing Event Configuration		
Item	Value setting	Description
<b>Event</b>	<b>None</b> by default	Specify the Event type ( <b>SMS</b> , or <b>SNMP Trap</b> ) and an event identifier / profile. Up to 3 event conditions can be specified for defining an event, and the event will be triggered when all the conditions hold simultaneously (AND relation).  The supported Event types could be: <b>SMS:</b> Select <b>SMS</b> and fill the message in the textbox to as the trigger condition for the event; <b>SNMP:</b> Select <b>SNMP Trap</b> and fill the message in the textbox to specify SNMP Trap Event;  <i>Note: The available Event Type could be different for the purchased product.</i>
<b>Trigger Type</b>	<b>Period</b> is selected by default	Specify the type of event trigger, either <b>Period</b> or <b>Once</b> . <b>Period:</b> Select <b>Period</b> and specify a time interval, the event will be repeatedly triggered on every time interval when the specified event condition holds. <b>Once:</b> Select <b>Once</b> and the event will be just triggered just one time when the specified event condition holds.
<b>Interval</b>	<b>0</b> is set by default	Specify the repeatedly event trigger time interval.  <b>Value Range:</b> 0 ~86400 seconds.
<b>Description</b>	String format : any text.	Enter a brief description for the Managing Event.

# 4G LTE M2M Router

<b>Action</b>	All box is unchecked by default.	<p>Specify <b>Network Status</b>, or at least one rest action to take when the expected event is triggered.</p> <p><b>Network Status:</b> Select <b>Network Status</b> Checkbox to get the network status as the action for the event;</p> <p><b>LAN&amp;VLAN:</b> Select <b>LAN&amp;VLAN</b> Checkbox and the interested sub-items (Port link On/Off), the gateway will change the settings as the action for the event;</p> <p><b>WiFi:</b> Select <b>WiFi</b> Checkbox and the interested sub-items (WiFi radio On/Off), the gateway will change the settings as the action for the event;</p> <p><b>NAT:</b> Select <b>NAT</b> Checkbox and the interested sub-items (Virtual Server Rule On/Off, DMZ On/Off), the gateway will change the settings as the action for the event;</p> <p><b>Firewall:</b> Select <b>Firewall</b> Checkbox and the interested sub-items (Remote Administrator Host ID On/Off), the gateway will change the settings as the action for the event;</p> <p><b>VPN:</b> Select <b>VPN</b> Checkbox and the interested sub-items (IPSec Tunnel ON/Off, PPTP Client On/Off, L2TP Client On/Off, OpenVPN Client On/Off), the gateway will change the settings as the action for the event;</p> <p><b>GRE:</b> Select <b>GRE</b> Checkbox and the interested sub-items (GRE Tunnel On/Off), the gateway will change the settings as the action for the event;</p> <p><b>System Manage:</b> Select <b>System Manage</b> Checkbox and the interested sub-items (WAN SSH Service On/Off), the gateway will change the settings as the action for the event;</p> <p><b>Administration:</b> Select <b>Administration</b> Checkbox and the interested sub-items (Backup Config, Restore Config, Reboot, Save Current Setting as Default), the gateway will change the settings as the action for the event;</p> <p><b>Digital Output:</b> Select <b>Digital Output</b> checkbox and a DO profile you defined as the action for the event;</p> <p><b>Remote Host:</b> Select <b>Remote Host</b> checkbox and a Remote Host profile you defined as the action for the event;</p>
<b>Managing Event</b>	The box is unchecked by default.	<p><i>Note: The available Event Type could be different for the purchased product.</i></p> <p>Click <b>Enable</b> box to activate this Managing Event setting.</p>
<b>Save</b>	NA	Click the <b>Save</b> button to save the configuration
<b>Undo</b>	NA	Click the <b>Undo</b> button to restore what you just configured back to the previous setting.

# 4G LTE M2M Router

## 7.2.3 Notifying Events

Go to **Service > SMS & Event > Notifying Events** Tab.

Notifying Events Setting allows administrator to define the relationship (rule) between event trigger and handlers.

### Enable Notifying Events

Configuration	
Item	Setting
▶ Notifying Events	<input checked="" type="checkbox"/> Enable

Item	Value setting	Description
<b>Notifying Events</b>	The box is unchecked by default	Check the <b>Enable</b> box to activate the Notifying Events function.

### Create / Edit Notifying Event Rules

Setup your Notifying Event rules. It supports up to a maximum of 128 rules.

Notifying Event List								
ID	Event Name	Event	Trigger Type	Description	Action	Time Schedule	Enable	Actions

When **Add** or **Edit** button is applied, the **Notifying Event Configuration** screen will appear.

Notifying Event Configuration	
Item	Setting
▶ Event Name	<input type="text"/>
▶ Event	None ▼
	None ▼
	None ▼
▶ Trigger Type	Period ▼
▶ Interval	<input type="text" value="0"/> (0~86400 seconds)
▶ Description	<input type="text"/>

# 4G LTE M2M Router

▶ Action	<input type="checkbox"/> SMS <input type="checkbox"/> Syslog <input type="checkbox"/> SNMP Trap (Only Support v1 and v2c) <input type="checkbox"/> Email Alert <input type="checkbox"/> Remote Host
▶ Time Schedule	(0) Always ▾
▶ Notifying Events	<input checked="" type="checkbox"/> Enable

## Notifying Event Configuration

Item	Value setting	Description
<b>Event</b>	<b>None</b> by default	<p>Specify the Event type and corresponding event configuration. Up to 3 event conditions can be specified for defining an event, and the event will be triggered when all the conditions hold simultaneously (AND relation).</p> <p>The supported Event Type could be:  <b>Power Change:</b> Select <b>Power Change</b> and a trigger condition to specify the event on a certain power source.  <b>WAN:</b> Select <b>WAN</b> and a trigger condition to specify a certain WAN Event;  <b>LAN&amp;VLAN:</b> Select <b>LAN&amp;VLAN</b> and a trigger condition to specify a certain LAN&amp;VLAN Event;  <b>WiFi:</b> Select <b>WiFi</b> and a trigger condition to specify a certain WiFi Event;  <b>DDNS:</b> Select <b>DDNS</b> and a trigger condition to specify a certain DDNS Event;  <b>Administration:</b> Select <b>Administration</b> and a trigger condition to specify a certain Administration Event;  <b>Data Usage:</b> Select <b>Data Usage</b>, the SIM Card (Cellular Service) and a trigger condition to specify a certain Data Usage Event;</p> <p><i>Note: The available Event Type could be different for the purchased product.</i></p>
<b>Description</b>	String format : any text.	Enter a brief description for the Notifying Event.
<b>Action</b>	All box is unchecked by default.	<p>Specify at least one action to take when the expected event is triggered.  <b>SMS:</b> Select <b>SMS</b>, and the gateway will send out a SMS to all the defined SMS accounts as the action for the event;  <b>Syslog:</b> Select <b>Syslog</b> and select/unselect the Enable Checkbox to as the action for the event;  <b>SNMP Trap:</b> Select <b>SNMP Trap</b>, and the gateway will send out SNMP Trap to the defined SNMP Event Receivers as the action for the event;  <b>Email Alert:</b> Select <b>Email Alert</b>, and the gateway will send out an Email to the defined Email accounts as the action for the event;  <b>Remote Host:</b> Select <b>Remote Host</b> checkbox and a Remote Host profile you defined as the action for the event;</p> <p><i>Note: The available Event Type could be different for the purchased product.</i></p>
<b>Time Schedule</b>	<b>(0) Always</b> is selected by default	Select a time scheduling rule for the Notifying Event.
<b>Notifying Events</b>	The box is unchecked by default.	Click <b>Enable</b> box to activate this Notifying Event setting.
<b>Save</b>	NA	Click the <b>Save</b> button to save the configuration
<b>Undo</b>	NA	Click the <b>Undo</b> button to restore what you just configured back to the previous setting.

# 4G LTE M2M Router

## Chapter 8 Status

### 8.1 Dashboard

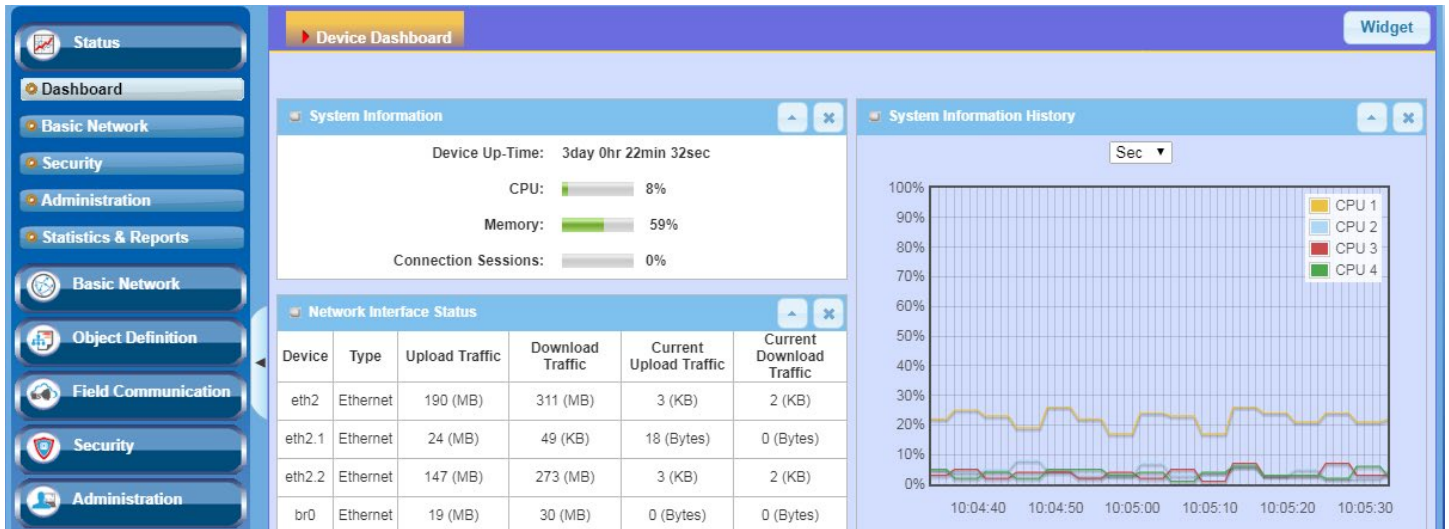

#### 8.1.1 Device Dashboard

The **Device Dashboard** window shows the current status in graph or tables for quickly understanding the operation status for the gateway. They are the System Information, System Information History, and Network Interface Status. The display will be refreshed once per second.

From the menu on the left, select **Status > Dashboard > Device Dashboard** tab.

#### System Information Status

The **System Information** screen shows the device Up-time and the resource utilization for the CPU, Memory, and Connection Sessions.

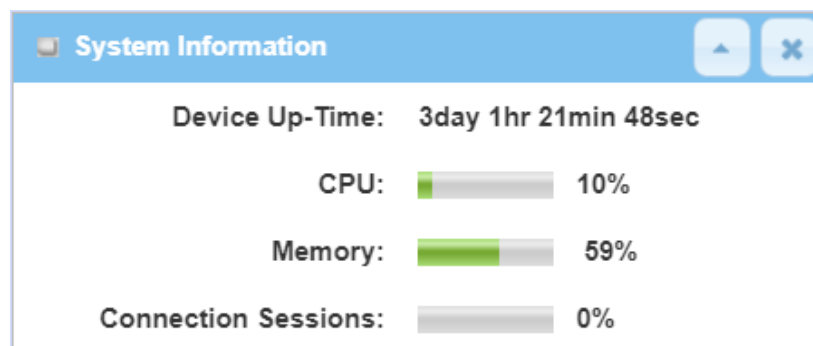

# 4G LTE M2M Router

## System Information History

The **System Information History** screen shows the statistic graphs for the CPU and memory.

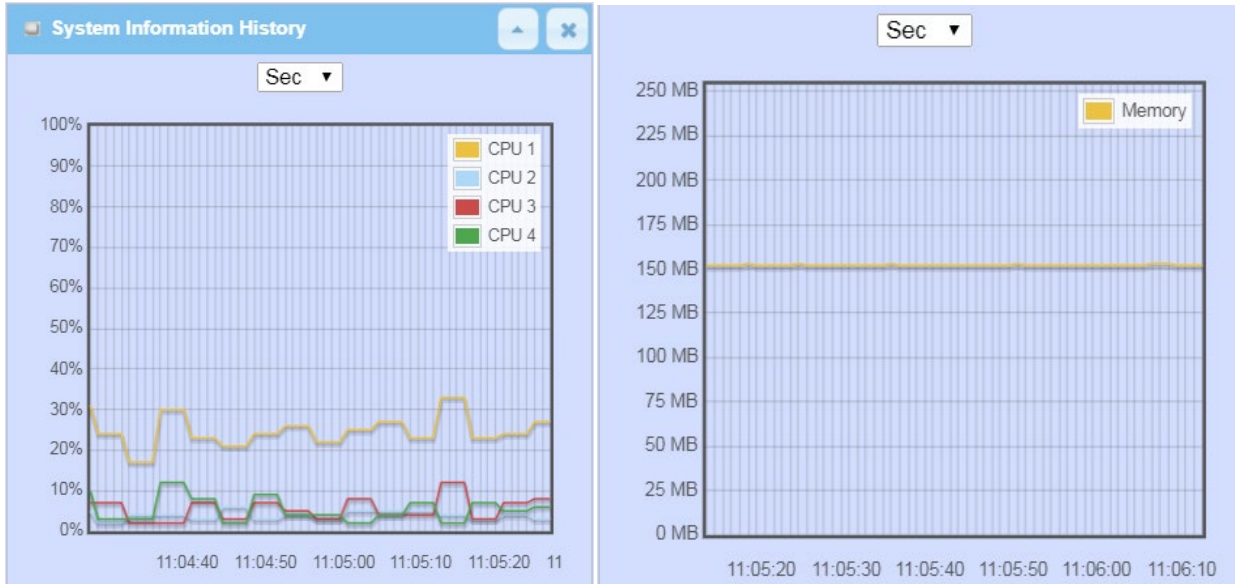

## Network Interface Status

The **Network Interface Status** screen shows the statistic information for each network interface of the gateway. The statistic information includes the Interface Type, Upload Traffic, Download Traffic, and Current Upload / Download Traffic.

Device	Type	Upload Traffic	Download Traffic	Current Upload Traffic	Current Download Traffic
eth2	Ethernet	211 (MB)	321 (MB)	3 (KB)	3 (KB)
eth2.1	Ethernet	24 (MB)	71 (KB)	64 (Bytes)	0 (Bytes)
eth2.2	Ethernet	168 (MB)	283 (MB)	3 (KB)	3 (KB)
br0	Ethernet	19 (MB)	31 (MB)	42 (Bytes)	0 (Bytes)
ra0	Wireless LAN	1 (MB)	1 (MB)	0 (Bytes)	0 (Bytes)
rai0	Wireless LAN	21 (MB)	42 (MB)	0 (Bytes)	0 (Bytes)
ra1	Wireless LAN	0 (Bytes)	0 (Bytes)	0 (Bytes)	0 (Bytes)
rai1	Wireless LAN	362 (Bytes)	4 (KB)	0 (Bytes)	0 (Bytes)
tun0	Ethernet	0 (Bytes)	0 (Bytes)	0 (Bytes)	0 (Bytes)

# 4G LTE M2M Router

## 8.2 Basic Network

### 8.2.1 WAN & Uplink Status

Go to **Status > Basic Network > WAN & Uplink** tab.

The **WAN & Uplink Status** window shows the current status for different network type, including network configuration, connecting information, modem status and traffic statistics. The display will be refreshed on every five seconds.

#### WAN interface IPv4 Network Status

WAN interface IPv4 Network Status screen shows status information for IPv4 network.

WAN Interface IPv4 Network Status										
ID	Interface	WAN Type	Network Type	IP Addr.	Subnet Mask	Gateway	DNS	MAC Address	Conn. Status	Action
WAN-1	3G/4G	3G/4G	NAT	10.59.152.73	255.255.255.252	10.59.152.74	168.95.1.1, 168.95.192.1	N/A	Connected 0 day 0:26:38	Edit
WAN-2		Disable								Edit

WAN interface IPv4 Network Status		
Item	Value setting	Description
<b>ID</b>	N/A	It displays corresponding WAN interface WAN IDs.
<b>Interface</b>	N/A	It displays the type of WAN physical interface. Depending on the model purchased, it can be Ethernet, 3G/4G, or WiFi Uplink.
<b>WAN Type</b>	N/A	It displays the method which public IP address is obtained from your ISP. Depending on the model purchased, it can be Static IP, Dynamic IP, PPPoE, PPTP, L2TP, 3G/4G.
<b>Network Type</b>	N/A	It displays the network type for the WAN interface(s). Depending on the model purchased, it can be NAT, Routing, Bridge, or IP Pass-through.
<b>IP Addr.</b>	N/A	It displays the public IP address obtained from your ISP for Internet connection. Default value is 0.0.0.0 if left unconfigured.
<b>Subnet Mask</b>	N/A	It displays the Subnet Mask for public IP address obtained from your ISP for Internet connection. Default value is 0.0.0.0 if left unconfigured.
<b>Gateway</b>	N/A	It displays the Gateway IP address obtained from your ISP for Internet connection. Default value is 0.0.0.0 if left unconfigured.
<b>DNS</b>	N/A	It displays the IP address of DNS server obtained from your ISP for Internet connection. Default value is 0.0.0.0 if left unconfigured.
<b>MAC Address</b>	N/A	It displays the MAC Address for your ISP to allow you for Internet access. Note: Not all ISP may require this field.
<b>Conn. Status</b>	N/A	It displays the connection status of the device to your ISP. Status are Connected or disconnected.

# 4G LTE M2M Router

Action	N/A	<p>This area provides functional buttons.</p> <p><b>Renew</b> button allows user to force the device to request an IP address from the DHCP server. Note: <b>Renew</b> button is available when DHCP WAN Type is used and WAN connection is disconnected.</p> <p><b>Release</b> button allows user to force the device to clear its IP address setting to disconnect from DHCP server. Note: <b>Release</b> button is available when DHCP WAN Type is used and WAN connection is connected.</p> <p><b>Connect</b> button allows user to manually connect the device to the Internet. Note: Connect button is available when Connection Control in WAN Type setting is set to Connect Manually (Refer to <b>Edit</b> button in <b>Basic Network &gt; WAN &amp; Uplink &gt; Internet Setup</b>) and WAN connection status is disconnected.</p> <p><b>Disconnect</b> button allows user to manually disconnect the device from the Internet. Note: <b>Connect</b> button is available when Connection Control in WAN Type setting is set to Connect Manually (Refer to <b>Edit</b> button in <b>Basic Network &gt; WAN &amp; Uplink &gt; Internet Setup</b>) and WAN connection status is connected.</p>
--------	-----	---

## WAN interface IPv6 Network Status

WAN interface IPv6 Network Status screen shows status information for IPv6 network.

WAN Interface IPv6 Network Status						
ID	Interface	WAN type	Link-local IP Address	Global IP Address	Conn. Status	Action
WAN-1	3G/4G	IPv6		/64	Disconnected	<input type="button" value="Edit"/>

WAN interface IPv6 Network Status		
Item	Value setting	Description
<b>ID</b>	N/A	It displays corresponding WAN interface WAN IDs.
<b>Interface</b>	N/A	It displays the type of WAN physical interface. Depending on the model purchased, it can be Ethernet, 3G/4G, etc...
<b>WAN Type</b>	N/A	It displays the method which public IP address is obtained from your ISP. WAN type setting can be changed from <b>Basic Network &gt; IPv6 &gt; Configuration</b> .
<b>Link-local IP Address</b>	N/A	It displays the LAN IPv6 Link-Local address.
<b>Global IP Address</b>	N/A	It displays the IPv6 global IP address assigned by your ISP for your Internet connection.
<b>Conn. Status</b>	N/A	It displays the connection status. The status can be connected, disconnected and connecting.
<b>Action</b>	N/A	This area provides functional buttons. <b>Edit Button</b> when pressed, web-based utility will take you to the IPv6 configuration page. ( <b>Basic Network &gt; IPv6 &gt; Configuration</b> .)

# 4G LTE M2M Router

## LAN Interface Network Status

LAN Interface Network Status screen shows IPv4 and IPv6 information of LAN network.

LAN Interface Network Status					
IPv4 Address	IPv4 Subnet Mask	IPv6 Link-local Address	IPv6 Global Address	MAC Address	Action
192.168.66.1	255.255.254.0	fe80::250:18ff:fe3a:4a5f	/64	00:50:18:3A:4A:5F	<a href="#">Edit IPv4</a> <a href="#">Edit IPv6</a>

Item	Value setting	Description
IPv4 Address	N/A	It displays the current IPv4 IP Address of the gateway This is also the IP Address user use to access Router's Web-based Utility.
IPv4 Subnet Mask	N/A	It displays the current mask of the subnet.
IPv6 Link-local Address	N/A	It displays the current LAN IPv6 Link-Local address. This is also the IPv6 IP Address user use to access Router's Web-based Utility.
IPv6 Global Address	N/A	It displays the current IPv6 global IP address assigned by your ISP for your Internet connection.
MAC Address	N/A	It displays the LAN MAC Address of the gateway
Action	N/A	This area provides functional buttons. <b>Edit IPv4 Button</b> when press, web-based utility will take you to the Ethernet LAN configuration page. ( <b>Basic Network &gt; LAN &amp; VLAN &gt; Ethernet LAN</b> tab). <b>Edit IPv6 Button</b> when press, web-based utility will take you to the IPv6 configuration page. ( <b>Basic Network &gt; IPv6 &gt; Configuration</b> .)

## 3G/4G Modem Status

3G/4G Modem Status List screen shows status information for 3G/4G WAN network(s).

3G/4G Modem Status List					
Interface	Card Information	Link Status	Signal Strength	Network Name	Action
3G/4G	ZM8620	Connected	70% (-69dBm)	Chunghwa Telecom (LTE)	<a href="#">Detail</a>

Item	Value setting	Description
Physical Interface	N/A	It displays the type of WAN physical interface. Note: Some device model may support two 3G/4G modules. Their physical interface name will be <b>3G/4G-1</b> and <b>3G/4G-2</b> .
Card Information	N/A	It displays the vendor's 3G/4G modem model name.

# 4G LTE M2M Router

<b>Link Status</b>	N/A	It displays the 3G/4G connection status. The status can be Connecting, Connected, Disconnecting, and Disconnected.
<b>Signal Strength</b>	N/A	It displays the 3G/4G wireless signal level.
<b>Network Name</b>	N/A	It displays the name of the service network carrier.
<b>Refresh</b>	N/A	Click the <b>Refresh</b> button to renew the information.
<b>Action</b>	N/A	This area provides functional buttons. <b>Detail Button</b> when press, windows of detail information will appear. They are the Modem Information, SIM Status, and Service Information. Refer to next page for more.

When the **Detail** button is pressed, 3G/4G modem information windows such as Modem Information, SIM Status, Service Information, Signal Strength / Quality, and Error Message will appear.

## Interface Traffic Statistics

Interface Traffic Statistics screen displays the Interface's total transmitted packets.

Interface Traffic Statistics				
ID	Interface	Received Packets(Mb)	Transmitted Packets(Mb)	Action
WAN-1	3G/4G	217.13	167.09	Reset
WAN-2		-	-	

Interface Traffic Statistics		
Item	Value setting	Description
<b>ID</b>	N/A	It displays corresponding WAN interface WAN IDs.
<b>Interface</b>	N/A	It displays the type of WAN physical interface. Depending on the model purchased, it can be Ethernet, 3G/4G, etc...
<b>Received Packets (Mb)</b>	N/A	It displays the downstream packets (Mb). It is reset when the device is rebooted.
<b>Transmitted Packets (Mb)</b>	N/A	It displays the upstream packets (Mb). It is reset when the device is rebooted.

# 4G LTE M2M Router

## 8.2.2 LAN & VLAN Status

Go to **Status > Basic Network > LAN & VLAN** tab.

### Client List

The **Client List** shows you the LAN Interface, IP address, Host Name, MAC Address, and Remaining Lease Time of each device that is connected to this gateway.

LAN Client List				
LAN Interface	IP Address	Host Name	MAC Address	Remaining Lease Time
Ethernet	Dynamic / 192.168.66.100	amit25613572	00-13-3B-0E-5B-1D	00:15:00

LAN Client List		
Item	Value setting	Description
<b>LAN Interface</b>	N/A	Client record of LAN Interface. String Format.
<b>IP Address</b>	N/A	Client record of IP Address Type and the IP Address. Type is String Format and the IP Address is IPv4 Format.
<b>Host Name</b>	N/A	Client record of Host Name. String Format.
<b>MAC Address</b>	N/A	Client record of MAC Address. MAC Address Format.
<b>Remaining Lease Time</b>	N/A	Client record of Remaining Lease Time. Time Format.

# 4G LTE M2M Router

## 8.2.3 WiFi Status

Go to **Status > Basic Network > WiFi** tab.

The **WiFi Status** window shows the overall statistics of WiFi VAP entries.

### WiFi Virtual AP List

The WiFi Virtual AP List shows all of the virtual AP information on each WiFi module. The **Edit** button allows for quick configuration changes.

WiFi Module One Virtual AP List									
Op. Band	ID	WiFi Enable	Op. Mode	SSID	Channel	WiFi System	Auth.&Security	MAC Address	Action
2.4G	VAP-1	<input checked="" type="checkbox"/>	WiFi Uplink	Staff_2.4G	1	b/g/n Mixed	WPA2-PSK(AES)	00:50:18:3A:4A:5F	<a href="#">Edit</a> <a href="#">QR Code</a>
2.4G	VAP-2	<input checked="" type="checkbox"/>	WiFi Uplink	default	1	b/g/n Mixed	Open(None)	02:50:18:38:4A:5F	<a href="#">Edit</a> <a href="#">QR Code</a>
2.4G	VAP-3	<input type="checkbox"/>	WiFi Uplink	default	1	b/g/n Mixed	WPA2-PSK(AES)	02:50:18:39:4A:5F	<a href="#">Edit</a> <a href="#">QR Code</a>
2.4G	VAP-4	<input type="checkbox"/>	WiFi Uplink	default	1	b/g/n Mixed	WPA2-PSK(AES)	02:50:18:3A:4A:5F	<a href="#">Edit</a> <a href="#">QR Code</a>
2.4G	VAP-5	<input type="checkbox"/>	WiFi Uplink	default	1	b/g/n Mixed	WPA2-PSK(AES)	02:50:18:3B:4A:5F	<a href="#">Edit</a> <a href="#">QR Code</a>
2.4G	VAP-6	<input type="checkbox"/>	WiFi Uplink	default	1	b/g/n Mixed	WPA2-PSK(AES)	02:50:18:3C:4A:5F	<a href="#">Edit</a> <a href="#">QR Code</a>
2.4G	VAP-7	<input type="checkbox"/>	WiFi Uplink	default	1	b/g/n Mixed	WPA2-PSK(AES)	02:50:18:3D:4A:5F	<a href="#">Edit</a> <a href="#">QR Code</a>

WiFi Virtual AP List		
Item	Value setting	Description
<b>Op. Band</b>	N/A	It displays the Wi-Fi Operation Band (2.4G or 5G) of VAP.
<b>ID</b>	N/A	It displays the ID of VAP.
<b>WiFi Enable</b>	N/A	It displays whether the VAP wireless signal is enabled or disabled.
<b>Op. Mode</b>	N/A	The Wi-Fi Operation Mode of VAP. Depends of device model, modes are AP Router, WDS Only and WDS Hybrid, Universal Repeater and Client.
<b>SSID</b>	N/A	It displays the network ID of VAP.
<b>Channel</b>	N/A	It displays the wireless channel used.
<b>WiFi System</b>	N/A	The WiFi System of VAP.
<b>Auth. &amp; Security</b>	N/A	It displays the authentication and encryption type used.
<b>MAC Address</b>	N/A	It displays MAC Address of VAP.
<b>Action</b>	N/A	Click the <b>Edit</b> button to make a quick access to the WiFi configuration page. ( <b>Basic Network &gt; WiFi &gt; Configuration</b> tab) The <b>QR Code</b> button allow you to generate QR code for quick connect to the VAP by scanning the QR code.

# 4G LTE M2M Router

## WiFi Uplink Status

The WiFi Uplink Status shows all information of connected WiFi uplink network on each WiFi module..

WiFi Module One Uplink Status							
SSID	BSSID	Channel	Security	RSSI0	RSSI1	Rate	Action
Only_For_Monkey	00:00:00:00:00:00	1	WPA2-PSK(AES)	0	0	0	Edit

WiFi Module One Uplink Status		
Item	Value setting	Description
SSID	N/A	It displays the network ID of VAP.
BSSID	N/A	It displays the theBSSID for the connected wireless network.
Channel	N/A	It displays the wireless channel used.
Security	N/A	It displays the authentication and encryption setting for the WiFi uplink connection.
RSSI0, RSSI1	N/A	It displays the Rx sensitivity on each radio path..
Rate	N/A	It displays the link rate for the WiFi uplink connection.
Action	N/A	Click the <b>Edit</b> button to make a quick access to the WiFi uplink configuration page. ( <b>Basic Network &gt; WAN &amp; Uplink &gt; Internet Setup</b> tab)

## WiFi IDS Status

The WiFi IDS Status shows all the WIDS statistics on each WiFi module.

WiFi Module One IDS Status								
Authentication Frame	Association Request Frame	Re-association Request Frame	Probe Request Frame	Disassociation Frame	Deauthentication Frame	EAP Request Frame	Malicious Data Frame	Action
0	0	0	0	0	0	0	0	Reset

WiFi IDS Status		
Item	Value setting	Description
Authentication Frame	N/A	It displays the receiving Authentication Frame count.
Association Request Frame	N/A	It displays the receiving Association Request Frame count.
Re-association Request Frame	N/A	It displays the receiving Re-association Request Frame count.
Probe Request Frame	N/A	It displays the receiving Probe Request Frame count.
Disassociation Frame	N/A	It displays the receiving Disassociation Frame count.
Deauthentication Frame	N/A	It displays the receiving Deauthentication Frame count.
EAP Request Frame	N/A	It displays the receiving EAP Request Frame count.
Malicious Data Frame	N/A	It displays the number of receiving unauthorized wireless packets.
Action	N/A	Click the <b>Reset</b> button to clear the entire statistic and reset counter to 0.

# 4G LTE M2M Router

Ensure WIDS function is enabled

Go to **Basic Network > WiFi > Advanced Configuration tab**

Note that the WIDS of **2.4GHz** or **5GHz WiFi** should be configured **separately**.

## WiFi Traffic Statistic

The WiFi Traffic Statistic shows all the received and transmitted packets on each WiFi module.

WiFi Module One Traffic Statistics				
Op. Band	ID	Received Packets	Transmitted Packets	Action
2.4G	VAP-1	269	80	Reset
2.4G	VAP-2	26	8	Reset
2.4G	VAP-3	0	0	Reset
2.4G	VAP-4	0	0	Reset
2.4G	VAP-5	0	0	Reset
2.4G	VAP-6	0	0	Reset
2.4G	VAP-7	0	0	Reset

WiFi Traffic Statistic		
Item	Value setting	Description
<b>Op. Band</b>	N/A	It displays the Wi-Fi Operation Band (2.4G or 5G) of VAP.
<b>ID</b>	N/A	It displays the VAP ID.
<b>Received Packets</b>	N/A	It displays the number of received packets.
<b>Transmitted Packet</b>	N/A	It displays the number of transmitted packets.
<b>Action</b>	N/A	Click the <b>Reset</b> button to clear individual VAP statistics.
<b>Refresh Button</b>	N/A	Click the <b>Refresh</b> button to update the entire VAP Traffic Statistic instantly.

# 4G LTE M2M Router

## 8.2.4 DDNS Status

Go to **Status > Basic Network > DDNS** tab.

The **DDNS Status** window shows the current DDNS service in use, the last update status, and the last update time to the DDNS service server.

### DDNS Status

DDNS Status List				
Host Name	Provider	Effective IP	Last Update Status	Last Update Time

DDNS Status		
Item	Value Setting	Description
Host Name	N/A	It displays the name you entered to identify DDNS service provider
Provider	N/A	It displays the DDNS server of DDNS service provider
Effective IP	N/A	It displays the public IP address of the device updated to the DDNS server
Last Update Status	N/A	It displays whether the last update of the device public IP address to the DDNS server has been successful (Ok) or failed (Fail).
Last Update Time	N/A	It displays time stamp of the last update of public IP address to the DDNS server.
Refresh	N/A	The refresh button allows user to force the display to refresh information.

# 4G LTE M2M Router

## 8.3 Security

The screenshot shows the router's management interface. On the left is a sidebar with navigation buttons: Status, Dashboard, Basic Network, Security, Administration, and Statistics & Reports. The main area is titled 'VPN Firewall' and contains four expandable widget sections:

- IPSec Tunnel Status**: A table with columns: ID, Tunnel Name, Tunnel Scenario, Local Subnets, Remote IP/FQDN, Remote Subnets, Conn. Time, Status.
- OpenVPN Client Status**: A table with columns: ID, OpenVPN Client Name, Interface, Remote IP/FQDN, Remote Subnet, Virtual IP, Conn. Time, Conn. Status.
- L2TP Client Status**: A table with columns: ID, L2TP Client Name, Interface, Virtual IP, Remote IP/FQDN, Default Gateway/Remote Subnet, Conn. Time, Status.
- PPTP Client Status**: A table with columns: ID, PPTP Client Name, Interface, Virtual IP, Remote IP/FQDN, Default Gateway/Remote Subnet, Conn. Time, Status.

### 8.3.1 VPN Status

Go to **Status > Security > VPN** tab.

The **VPN Status** window shows the overall VPN tunnel status. The display will be refreshed on every five seconds.

#### IPSec Tunnel Status

**IPSec Tunnel Status** windows show the configuration for establishing IPSec VPN connection and current connection status.

ID	Tunnel Name	Tunnel Scenario	Local Subnets	Remote IP/FQDN	Remote Subnets	Conn. Time	Status
----	-------------	-----------------	---------------	----------------	----------------	------------	--------

IPSec Tunnel Status Item	Value setting	Description
<b>Tunnel Name</b>	N/A	It displays the tunnel name you have entered to identify.
<b>Tunnel Scenario</b>	N/A	It displays the Tunnel Scenario specified.
<b>Local Subnets</b>	N/A	It displays the Local Subnets specified.
<b>Remote IP/FQDN</b>	N/A	It displays the Remote IP/FQDN specified.
<b>Remote Subnets</b>	N/A	It displays the Remote Subnets specified.

# 4G LTE M2M Router

<b>Conn. Time</b>	N/A	It displays the connection time for the IPSec tunnel.
<b>Status</b>	N/A	It displays the Status of the VPN connection. The status displays are Connected, Disconnected, Wait for traffic, and Connecting.
<b>Edit Button</b>	N/A	Click on Edit Button to change IPSec setting, web-based utility will take you to the IPSec configuration page. ( <b>Security &gt; VPN &gt; IPSec</b> tab)

## OpenVPN Client Status

OpenVPN Client Status <span>Edit</span> <span>Detail</span>							
ID	OpenVPN Client Name	Interface	Remote IP/FQDN	Remote Subnet	Virtual IP	Conn. Time	Conn. Status
<b>OpenVPN Client Status</b>							
<b>Item</b>	<b>Value setting</b>	<b>Description</b>					
<b>OpenVPN Client Name</b>	N/A	It displays the Client name you have entered for identification.					
<b>Interface</b>	N/A	It displays the WAN interface specified for the OpenVPN client connection.					
<b>Remote IP/FQDN</b>	N/A	It displays the peer OpenVPN Server's Public IP address (the WAN IP address) or FQDN.					
<b>Remote Subnet</b>	N/A	It displays the Remote Subnet specified.					
<b>TUN/TAP Read(bytes)</b>	N/A	It displays the TUN/TAP Read Bytes of OpenVPN Client.					
<b>TUN/TAP Write(bytes)</b>	N/A	It displays the TUN/TAP Write Bytes of OpenVPN Client.					
<b>TCP/UDP Read(bytes)</b>	N/A	It displays the TCP/UDP Read Bytes of OpenVPN Client.					
<b>TCP/UDP Write(bytes)</b>	N/A	It displays the TCP/UDP Write Bytes of OpenVPN Client. Connection					
<b>Conn. Time</b>	N/A	It displays the connection time for the corresponding OpenVPN tunnel.					
<b>Conn. Status</b>	N/A	It displays the connection status of the corresponding OpenVPN tunnel. The status can be Connected, or Disconnected.					

## L2TP Client Status

L2TP Client Status shows the configuration for establishing L2TP tunnel and current connection status.

L2TP Client Status <span>Edit</span>							
ID	L2TP Client Name	Interface	Virtual IP	Remote IP/FQDN	Default Gateway/Remote Subnet	Conn. Time	Status
<b>L2TP Client Status</b>							
<b>Item</b>	<b>Value setting</b>	<b>Description</b>					
<b>Client Name</b>	N/A	It displays Name for the L2TP Client specified.					
<b>Interface</b>	N/A	It displays the WAN interface with which the gateway will use to request PPTP tunneling connection to the PPTP server.					

# 4G LTE M2M Router

<b>Virtual IP</b>	N/A	It displays the IP address assigned by Virtual IP server of L2TP server.
<b>Remote IP/FQDN</b>	N/A	It displays the L2TP Server's Public IP address (the WAN IP address) or FQDN.
<b>Default Gateway/Remote Subnet</b>	N/A	It displays the specified IP address of the gateway device used to connect to the internet to connect to the L2TP server –the default gateway. Or other specified subnet if the default gateway is not used to connect to the L2TP server –the remote subnet.
<b>Conn. Time</b>	N/A	It displays the connection time for the L2TP tunnel.
<b>Status</b>	N/A	It displays the Status of the VPN connection. The status displays Connected, Disconnect, and Connecting.
<b>Edit</b>	N/A	Click on <b>Edit</b> Button to change L2TP client setting, web-based utility will take you to the L2TP client page. ( <b>Security &gt; VPN &gt; L2TP</b> tab)

## PPTP Client Status

**PPTP Client Status** shows the configuration for establishing PPTP tunnel and current connection status.

ID	PPTP Client Name	Interface	Virtual IP	Remote IP/FQDN	Default Gateway/Remote Subnet	Conn. Time	Status
----	------------------	-----------	------------	----------------	-------------------------------	------------	--------

PPTP Client Status		
Item	Value setting	Description
<b>Client Name</b>	N/A	It displays Name for the PPTP Client specified.
<b>Interface</b>	N/A	It displays the WAN interface with which the gateway will use to request PPTP tunneling connection to the PPTP server.
<b>Virtual IP</b>	N/A	It displays the IP address assigned by Virtual IP server of PPTP server.
<b>Remote IP/FQDN</b>	N/A	It displays the PPTP Server's Public IP address (the WAN IP address) or FQDN.
<b>Default Gateway / Remote Subnet</b>	N/A	It displays the specified IP address of the gateway device used to connect to the internet to connect to the PPTP server –the default gateway. Or other specified subnet if the default gateway is not used to connect to the PPTP server –the remote subnet.
<b>Conn. Time</b>	N/A	It displays the connection time for the PPTP tunnel.
<b>Status</b>	N/A	It displays the Status of the VPN connection. The status displays Connected, Disconnect, and Connecting.
<b>Edit Button</b>	N/A	Click on <b>Edit</b> Button to change PPTP client setting, web-based utility will take you to the PPTP server page. ( <b>Security &gt; VPN &gt; PPTP</b> tab)

# 4G LTE M2M Router

## 8.3.2 Firewall Status

Go to **Status > Security > Firewall Status** Tab.

The **Firewall Status** provides user a quick view of the firewall status and current firewall settings. It also keeps the log history of the dropped packets by the firewall rule policies, and includes the administrator remote login settings specified in the Firewall Options. The display will be refreshed on every five seconds.

By clicking the icon [+], the status table will be expanded to display log history. Clicking the **Edit** button the screen will be switched to the configuration page.

### Packet Filter Status

Packet Filters			
		<input type="button" value="Edit"/>	
Activated Filter Rule		Detected Contents	IP
			Time

Packet Filter Status		
Item	Value setting	Description
Activated Filter Rule	N/A	This is the Packet Filter Rule name.
Detected Contents	N/A	This is the logged packet information, including the source IP, destination IP, protocol, and destination port –the TCP or UDP. String format: Source IP to Destination IP : Destination Protocol (TCP or UDP)
IP	N/A	The Source IP (IPv4) of the logged packet.
Time	N/A	The Date and Time stamp of the logged packet. Date & time format. ("Month" "Day" "Hours":"Minutes":"Seconds")

*Note: Ensure Packet Filter Log Alert is enabled.*

*Refer to **Security > Firewall > Packet Filter** tab. Check Log Alert and save the setting.*

### URL Blocking Status

URL Blocking			
		<input type="button" value="Edit"/>	
Activated Blocking Rule		Blocked URL	IP
			Time

URL Blocking Status		
Item	Value setting	Description
Activated Blocking Rule	N/A	This is the URL Blocking Rule name.
Blocked URL	N/A	This is the logged packet information.
IP	N/A	The Source IP (IPv4) of the logged packet.

# 4G LTE M2M Router

Time	N/A	The Date and Time stamp of the logged packet. Date & time format. ("Month" "Day" "Hours":"Minutes":"Seconds")
------	-----	---

Note: Ensure URL Blocking Log Alert is enabled.

Refer to **Security > Firewall > URL Blocking** tab. Check Log Alert and save the setting.

## Web Content Filter Status

Web Content Filters <span>Edit</span>			
Activated Filter Rule	Detected Contents	IP	Time

Web Content Filter Status		
Item	Value setting	Description
Activated Filter Rule	N/A	Logged packet of the rule name. String format.
Detected Contents	N/A	Logged packet of the filter rule. String format.
IP	N/A	Logged packet of the Source IP. IPv4 format.
Time	N/A	Logged packet of the Date Time. Date time format ("Month" "Day" "Hours":"Minutes":"Seconds")

Note: Ensure Web Content Filter Log Alert is enabled.

Refer to **Security > Firewall > Web Content Filter** tab. Check Log Alert and save the setting.

## MAC Control Status

MAC Control <span>Edit</span>			
Activated Control Rule	Blocked MAC Addresses	IP	Time

MAC Control Status		
Item	Value setting	Description
Activated Control Rule	N/A	This is the MAC Control Rule name.
Blocked MAC Addresses	N/A	This is the MAC address of the logged packet.
IP	N/A	The Source IP (IPv4) of the logged packet.
Time	N/A	The Date and Time stamp of the logged packet. Date & time format. ("Month" "Day" "Hours":"Minutes":"Seconds")

Note: Ensure MAC Control Log Alert is enabled.

Refer to **Security > Firewall > MAC Control** tab. Check Log Alert and save the setting.

# 4G LTE M2M Router

## Application Filters Status

Application Filters <span>Edit</span>			
Filtered Application Category	Filtered Application Name	IP	Time
<b>Application Filters Status</b>			
Item	Value setting	Description	
Filtered Application Category	N/A	The name of the Application Category being blocked.	
Filtered Application Name	N/A	The name of the Application being blocked.	
IP	N/A	The Source IP (IPv4) of the logged packet.	
Time	N/A	The Date and Time stamp of the logged packet. Date & time format. ("Month" "Day" "Hours":"Minutes":"Seconds")	

Note: Ensure Application Filter Log Alert is enabled.

Refer to **Security > Firewall > Application Filter** tab. Check Log Alert and save the setting.

## IPS Status

IPS <span>Edit</span>			
Detected Intrusion		IP	Time
<b>IPS Firewall Status</b>			
Item	Value setting	Description	
Detected Intrusion	N/A	This is the intrusion type of the packets being blocked.	
IP	N/A	The Source IP (IPv4) of the logged packet.	
Time	N/A	The Date and Time stamp of the logged packet. Date & time format. ("Month" "Day" "Hours":"Minutes":"Seconds")	

Note: Ensure IPS Log Alert is enabled.

Refer to **Security > Firewall > IPS** tab. Check Log Alert and save the setting.

# 4G LTE M2M Router

## Firewall Options Status

Options <span>Edit</span>			
Stealth Mode	SPI	Discard Ping from WAN	Remote Administrator Management
Disable	Disable	Disable	IP: 192.168.121.54, User Name: admin, Time: Apr 1 11:14:54

Firewall Options Status		
Item	Value setting	Description
Stealth Mode	N/A	Enable or Disable setting status of Stealth Mode on Firewall Options. String Format: Disable or Enable
SPI	N/A	Enable or Disable setting status of SPI on Firewall Options. String Format : Disable or Enable
Discard Ping from WAN	N/A	Enable or Disable setting status of Discard Ping from WAN on Firewall Options. String Format: Disable or Enable
Remote Administrator Management	N/A	Enable or Disable setting status of Remote Administrator. If Remote Administrator is enabled, it shows the currently logged in administrator's source IP address and login user name and the login time. Format: IP : "Source IP", User Name: "Login User Name", Time: "Date time" Example: IP: 192.168.127.39, User Name: admin, Time: Mar 3 01:34:13

Note: Ensure Firewall Options Log Alert is enabled.

Refer to **Security > Firewall > Options** tab. Check Log Alert and save the setting.

# 4G LTE M2M Router

## 8.4 Administration

### 8.4.1 Configure & Manage Status

Go to **Status > Administration > Configure & Manage** tab.

The **Configure & Manage Status** window shows the status for managing remote network devices. The type of management available in your device is depended on the device model purchased. The commonly used ones are the SNMP, D-ECS (D-LINK EDGE CLOUD SOLUTION), and UPnP. The display will be refreshed on every five seconds.

#### SNMP Linking Status

**SNMP Link Status** screen shows the status of current active SNMP connections.

SNMP Linking Status						
User Name	IP Address	Port	Community	Auth. Mode	Privacy Mode	SNMP Version

SNMP Link Status		
Item	Value setting	Description
User Name	N/A	It displays the user name for authentication. This is only available for SNMP version 3.
IP Address	N/A	It displays the IP address of SNMP manager.
Port	N/A	It displays the port number used to maintain connection with the SNMP manager.
Community	N/A	It displays the community for SNMP version 1 or version 2c only.
Auth. Mode	N/A	It displays the authentication method for SNMP version 3 only.
Privacy Mode	N/A	It displays the privacy mode for version 3 only.
SNMP Version	N/A	It displays the SNMP Version employed.

#### SNMP Trap Information

**SNMP Trap Information** screen shows the status of current received SNMP traps.

SNMP Trap Information		
Trap Level	Time	Trap Event

SNMP Trap Information		
Item	Value setting	Description
Trap Level	N/A	It displays the trap level.
Time	N/A	It displays the timestamp of trap event.
Trap Event	N/A	It displays the IP address of the trap sender and event type.

# 4G LTE M2M Router

## 8.4.2 Log Storage Status

Go to **Status > Administration > Log Storage** tab.

The **Log Storage Status** screen shows the status for selected device storage.

### Log Storage Status

**Log Storage Status** screen shows the status of current the selected device storage. The status includes Device Description, Usage, File System, Speed, and status.

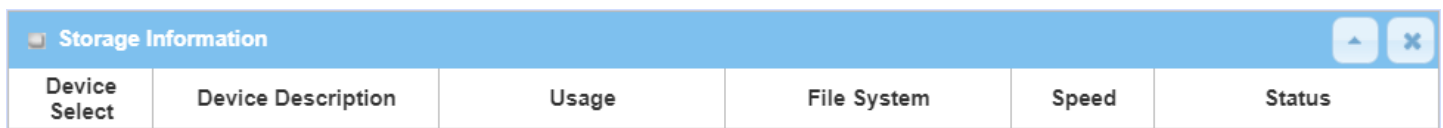

Storage Information					
Device Select	Device Description	Usage	File System	Speed	Status

# 4G LTE M2M Router

## 8.5 Statistics & Report

### 8.5.1 Connection Session

Go to **Status > Statistics & Reports > Connection Session** tab.

**Internet Surfing Statistic** shows the connection tracks on this router.

Internet Surfing List (14 entries) Previous Next First Last Export (.xml) Export (.csv)					
Refresh					
User Name	Protocol	Internal IP & Port	MAC	External IP & Port	Duration Time
	UDP	192.168.127.58:3847		88.198.95.100:1194	2019/04/01 12:09~
	UDP	192.168.127.58:4486		192.168.123.10:53	2019/04/01 12:09~
	UDP	192.168.127.58:2899		192.168.123.10:53	2019/04/01 12:09~
	UDP	192.168.127.58:1251		192.168.123.10:53	2019/04/01 12:09~
	UDP	192.168.127.58:3145		192.168.123.10:53	2019/04/01 12:09~

Internet Surfing Statistic		
Item	Value setting	Description
<b>Previous</b>	N/A	Click the <b>Previous</b> button; you will see the previous page of track list.
<b>Next</b>	N/A	Click the <b>Next</b> button; you will see the next page of track list.
<b>First</b>	N/A	Click the <b>First</b> button; you will see the first page of track list.
<b>Last</b>	N/A	Click the <b>Last</b> button; you will see the last page of track list.
<b>Export (.xml)</b>	N/A	Click the <b>Export (.xml)</b> button to export the list to xml file.
<b>Export (.csv)</b>	N/A	Click the <b>Export (.csv)</b> button to export the list to csv file.
<b>Refresh</b>	N/A	Click the <b>Refresh</b> button to refresh the list.

# 4G LTE M2M Router

## 8.5.2 Network Traffic (not supported)

Not supported feature for the purchased product, leave it as blank.

# 4G LTE M2M Router

## 8.5.3 Login Statistics

Go to **Status > Statistics & Reports > Login Statistics**

**Login Statistics** shows the login information.

Device Manager Login Statistics					
Refresh					
User Name	Protocol Type	IP Address	Info	Duration Time	
admin	HTTP	192.168.123.190	Admin	2018/01/01 00:00~	
admin	HTTP	192.168.123.190	Admin	2018/01/01 00:02~	
admin	HTTP	192.168.123.190	Login Fail	2019/06/05 16:30~	
admin	HTTP	192.168.123.190	Admin	2019/06/05 16:30~	

Device Manager Login Statistic Item	Value setting	Description
<b>Previous</b>	N/A	Click the <b>Previous</b> button; you will see the previous page of login statistics.
<b>Next</b>	N/A	Click the <b>Next</b> button; you will see the next page of login statistics.
<b>First</b>	N/A	Click the <b>First</b> button; you will see the first page of login statistics.
<b>Last</b>	N/A	Click the <b>Last</b> button; you will see the last page of login statistics.
<b>Export (.xml)</b>	N/A	Click the <b>Export (.xml)</b> button to export the login statistics to xml file.
<b>Export (.csv)</b>	N/A	Click the <b>Export (.csv)</b> button to export the login statistics to csv file.
<b>Refresh</b>	N/A	Click the <b>Refresh</b> button to refresh the login statistics.

# 4G LTE M2M Router

## 8.5.4 Cellular Usage

Go to **Status > Statistics & Reports > Cellular Usage** tab.

**Cellular Usage** screen shows data usage statistics for the selected cellular interface. The cellular data usage can be accumulated per hour or per day.



# 4G LTE M2M Router

Technical Specifications		
General		
Cellular Frequency Support <sup>1</sup>	SKU 1 (E) <ul style="list-style-type: none"> <li>LTE Cat. 4 Bands 1/3/5/7/8/20/38/40/41</li> <li>UMTS/HSPA B1/B5/B8, 850/900/2100 MHz</li> <li>GSM/GPRS/EDGE: 900/1800 MHz</li> </ul> SKU 4 (AU) <ul style="list-style-type: none"> <li>LTE Cat. 4 Bands 1/2/3/4/5/7/8/28/40</li> <li>UMTS/HSPA B1/B2/B5/B8, 850/900/1900/2100 MHz</li> <li>GSM/GPRS/EDGE: 850/900/1800/1900 MHz</li> </ul>	SKU 5 (J) <ul style="list-style-type: none"> <li>LTE Cat. 4 Bands 1/3/8/18/19/26/41</li> <li>UMTS/HSPA 1/6/8/19, 800/900/2100 MHz</li> </ul> SKU 6 (EU) <ul style="list-style-type: none"> <li>LTE Cat. 4 Bands 1/3/7/8/20/28A/38/40/41</li> <li>UMTS/HSPA B1/B8, 900/2100 MHz</li> <li>GSM/GPRS/EDGE: 900/1800 MHz</li> </ul> SKU 7 (AF) <ul style="list-style-type: none"> <li>LTE Cat. 4 Bands B2/B4/B5/B12/B13/B14/B66/B71</li> <li>UMTS/HSPA B2/B4/B5, 850/1700/1900 MHz</li> </ul>
Maximum Cellular Data Throughput	<ul style="list-style-type: none"> <li>LTE FDD: 150 Mbps (DL) / 50 Mbps (UL)</li> <li>LTE TDD: 130 Mbps (DL) / 30 Mbps (UL)</li> <li>DC-HSDPA/HSPA: 42 Mbps (DL) / 5.76 Mbps (UL)</li> </ul>	<ul style="list-style-type: none"> <li>WCDMA: 384 Kbps (DL) / 384 Kbps (UL)</li> <li>EDGE: 296 Kbps (DL) / 236.8 Kbps (UL)</li> <li>GPRS: 107 Kbps (DL) / 85.6 Kbps (UL)</li> </ul>
Device Interfaces	<ul style="list-style-type: none"> <li>One 10/100 Ethernet WAN/LAN port</li> <li>One 10/100 Ethernet LAN port</li> <li>Micro SD card slot</li> </ul>	<ul style="list-style-type: none"> <li>2 SIM slots (Micro-3FF)</li> <li>DC Input</li> <li>USB port for RS-232 (Tx/D, Rx/D)</li> </ul>
Antennas	<ul style="list-style-type: none"> <li>Two detachable 3G/4G antennas</li> </ul>	<ul style="list-style-type: none"> <li>One detachable Wi-Fi antenna (optional accessory)</li> </ul>
Standards	<ul style="list-style-type: none"> <li>IEEE 802.3i</li> <li>IEEE 802.3u</li> </ul>	<ul style="list-style-type: none"> <li>802.11n/g/b</li> </ul>
Wi-Fi Data Rates <sup>2</sup>	<ul style="list-style-type: none"> <li>Up to 150 Mbps with 802.11n clients</li> <li>6/9/11/12/18/24/36/48/54 Mbps in 802.11g mode</li> </ul>	<ul style="list-style-type: none"> <li>1/2/5.5/11 Mbps in 802.11b mode</li> </ul>
Advanced Features	<ul style="list-style-type: none"> <li>SNMP Support</li> <li>Web-based UI</li> <li>TR-069 CPE WAN Management Protocol</li> </ul>	<ul style="list-style-type: none"> <li>DECS</li> <li>Remote Management of UPS</li> <li>Remote Management of Devices</li> </ul>
Functionality		
Wireless Security Features	<ul style="list-style-type: none"> <li>64/128-bit WEP (Wired Equivalent Privacy)</li> </ul>	<ul style="list-style-type: none"> <li>802.11 128-bit AES</li> </ul>
Firewall	<ul style="list-style-type: none"> <li>Network Address Translation (NAT)</li> </ul>	<ul style="list-style-type: none"> <li>Stateful Packet Inspection (SPI)</li> </ul>
QoS	<ul style="list-style-type: none"> <li>Low, normal, and high priority levels according to source/destination IP or destination port</li> </ul>	
VPN	<ul style="list-style-type: none"> <li>IPSec/OpenVPN/PPTP/L2TP/GRE VPN</li> </ul>	
SMS	<ul style="list-style-type: none"> <li>New Incoming SMS notification</li> </ul>	<ul style="list-style-type: none"> <li>SMS compose, send, read, forward, reply, and delete</li> </ul>
Physical		
LED Status Indicators	<ul style="list-style-type: none"> <li>Network Connectivity</li> <li>Wi-Fi</li> </ul>	<ul style="list-style-type: none"> <li>Signal Strength</li> </ul>
Power	<ul style="list-style-type: none"> <li>5 V / 2 A adapter</li> </ul>	<ul style="list-style-type: none"> <li>Flexible Input: DC 5V / 2 A – 18 V / 0.7 A</li> </ul>
Enclosure	<ul style="list-style-type: none"> <li>Corrosion-resistant zinc-plated steel</li> </ul>	
Dimensions	<ul style="list-style-type: none"> <li>93 x 70 x 23.6 mm (3.66 x 2.76 x 0.92 in)</li> </ul>	
Weight	<ul style="list-style-type: none"> <li>210 g (7.41 oz)</li> </ul>	
Temperature	<ul style="list-style-type: none"> <li>Operating: -30 to 60 °C (-22 to 140 °F)</li> </ul>	<ul style="list-style-type: none"> <li>Storage: -40 to 85 °C (-40 to 185 °F)</li> </ul>
Humidity	<ul style="list-style-type: none"> <li>Operating: 10% to 90% non-condensing</li> </ul>	<ul style="list-style-type: none"> <li>Storage: 0 to 95% non-condensing</li> </ul>
Order Information		
Part Number	Description	
DWM-313	4G LTE M2M Router	