

VigorSwitch PQ2300xb / Q2300x L2+ Managed Switch Quick Start Guide

Version: 1.01

Firmware Version: V2.9.4

(For future update, please visit DrayTek web site)

Date: September 23, 2025

Intellectual Property Rights (IPR) Information

Copyrights	© All rights reserved. This publication contains information that is protected by copyright. No part may be reproduced, transmitted, transcribed, stored in a retrieval system, or translated into any language without written permission from the copyright holders.
Trademarks	The following trademarks are used in this document: <ul style="list-style-type: none">● Microsoft is a registered trademark of Microsoft Corp.● Windows 8, 10, 11 and Explorer are trademarks of Microsoft Corp.● Apple and Mac OS are registered trademarks of Apple Inc.● Other products may be trademarks or registered trademarks of their respective manufacturers.

Safety Instructions and Approval

Safety Instructions	<ul style="list-style-type: none">● Read the installation guide thoroughly before you set up the switch.● The switch is a complicated electronic unit that may be repaired only by authorized and qualified personnel. Do not try to open or repair the switch yourself.● Do not place the switch in a damp or humid place, e.g. a bathroom.● The switch should be used in a sheltered area, within a temperature range of +5 to +45 Celsius.● Do not expose the switch to direct sunlight or other heat sources. The housing and electronic components may be damaged by direct sunlight or heat sources.● Do not deploy the cable for LAN connection outdoor to prevent electronic shock hazards.● Do not power off the device when saving configurations or firmware upgrades. It may damage the data in a flash. Please disconnect the Internet connection on the device before powering it off when a TR-069/ACS server manages the device.● Keep the package out of reach of children.● When you want to dispose of the switch, please follow local regulations on conservation of the environment.
Warranty	We warrant to the original end user (purchaser) that the switch will be free from any defects in workmanship or materials for a period of two (2) years from the date of purchase from the dealer. Please keep your purchase receipt in a safe place as it serves as proof of date of purchase. During the warranty period, and upon proof of purchase, should the product have indications of failure due to faulty workmanship and/or materials, we will, at our discretion, repair or replace the defective products or components, without charge for either parts or labor, to whatever extent we deem necessary to restore the product to proper operating condition. Any replacement will consist of a new or re-manufactured functionally equivalent product of equal value, and will be offered solely at our discretion. This warranty will not apply if the product is modified, misused, tampered with, damaged by an act of God, or subjected to abnormal working conditions. The warranty does not cover the bundled or licensed software of other vendors. Defects which do not significantly affect the usability of the product will not be covered by the warranty. We reserve the right to revise the manual and online documentation and to make changes from time to time in the contents hereof without obligation to notify any person of such revision or changes.



EU Declaration of Conformity

Hereby, DrayTek Corporation declares that the equipment type VigorSwitch is in compliance with EU EMC Directive 2014/30/EU, Low Voltage Directive 2014/35/EU and RoHS 2011/65/EU.

The full text of the EU Declaration of Conformity is available at the following internet address:

<https://fw.draytek.com.tw/VigorSwitch%20Q2300x/Document/CE/>

- Product name: 24x2.5GbE + 6x10G SFP Ports Switch
- Model number: VigorSwitch Q2300x
- Manufacturer: DrayTek Corp.
- Address: No.26, Fushing Rd., Hukou, Hsinchu Industrial Park, Hsinchu 303, Taiwan



Declaration of Conformity

Hereby, DrayTek Corporation declares that the equipment type VigorSwitch is in compliance with The Electromagnetic Compatibility Regulations 2016 (SI 2016 No.1091), The Electrical Equipment (Safety) Regulations 2016 (SI 2016 No.1101), and The Restriction of the Use of Certain Hazardous Substances in Electrical and Electronic Equipment Regulations 2012 (SI 2012 No. 3032).

The full text of the UKCA Declaration of Conformity is available at the following internet address:

<https://fw.draytek.com.tw/VigorSwitch%20Q2300x/Document/CE/>

- Product name: 24x2.5GbE + 6x10G SFP Ports Switch
- Model number: VigorSwitch Q2300x
- Manufacturer: DrayTek Corp.
- Address: No.26, Fushing Rd., Hukou, Hsinchu Industrial Park, Hsinchu 303, Taiwan



EU Declaration of Conformity

Hereby, DrayTek Corporation declares that the equipment type VigorSwitch is in compliance with EU EMC Directive 2014/30/EU, Low Voltage Directive 2014/35/EU and RoHS 2011/65/EU.

The full text of the EU Declaration of Conformity is available at the following internet address:

<https://fw.draytek.com.tw/VigorSwitch%20PQ2300xb/Document/CE/>

- Product name: PoE 24x2.5GbE + 6x10G SFP Ports Switch
- Model number: VigorSwitch PQ2300xb
- Manufacturer: DrayTek Corp.
- Address: No.26, Fushing Rd., Hukou, Hsinchu Industrial Park, Hsinchu 303, Taiwan



Declaration of Conformity

Hereby, DrayTek Corporation declares that the equipment type VigorSwitch is in compliance with The Electromagnetic Compatibility Regulations 2016 (SI 2016 No.1091), The Electrical Equipment (Safety) Regulations 2016 (SI 2016 No.1101), and The Restriction of the Use of Certain Hazardous Substances in Electrical and Electronic Equipment Regulations 2012 (SI 2012 No. 3032).

The full text of the UKCA Declaration of Conformity is available at the following internet address:

<https://fw.draytek.com.tw/VigorSwitch%20PQ2300xb/Document/CE/>

- Product name: PoE 24x2.5GbE + 6x10G SFP Ports Switch
- Model number: VigorSwitch PQ2300xb
- Manufacturer: DrayTek Corp.
- Address: No.26, Fushing Rd., Hukou, Hsinchu Industrial Park, Hsinchu 303, Taiwan



UK PSTI STATEMENT OF COMPLIANCE

We, DrayTek Corp., office at No.26, Fushing Rd., Hukou, Hsinchu Industrial Park, Hsinchu 303, Taiwan, declare under our sole responsibility that the product

The full text of the PSTI Declaration of Conformity is available at the following internet address:
<https://fw.draytek.com.tw/UK/PSTI/>

- Product name: L2+ Management Switch
- Model number: VigorSwitch Q2300x, VigorSwitch PQ2300xb
- Manufacturer: DrayTek Corp.
- Address: No.26, Fushing Rd., Hukou, Hsinchu Industrial Park, Hsinchu 303, Taiwan

is in conformity with the relevant UK Statutory Instruments: The Product Security and Telecommunications Infrastructure (Security Requirements for Relevant Connectable Products) Regulations 2023 (“Security Requirements”).

Standard	Version
The Product Security and Telecommunications Infrastructure Regulations	2023 Schedule 1
Support Period	3 years after the EOL notification

Please note that this statement of compliance, including the Defined Support Period stated herein, is only applicable to products sold in the UK.

This Statement of Compliance is retained by DrayTek for 10 years after date of issue.

Hsinchu
(place)

25th April, 2024
(date)

Alan Wen
General Manager Office. VP
(Legal Signature)

Regulatory Information

Federal Communication Commission Interference Statement

This equipment has been tested and found to comply with the limits for a Class A digital device, pursuant to Part 15 of the FCC Rules. These limits are designed to provide reasonable protection against harmful interference in a residential installation. This equipment generates, uses and can radiate radio frequency energy and, if not installed and used in accordance with the instructions, may cause harmful interference to radio communications. However, there is no guarantee that interference will not occur in a particular installation. If this equipment does cause harmful interference to radio or television reception, which can be determined by turning the equipment off and on, the user is encouraged to try to correct the interference by one of the following measures:

- Reorient or relocate the receiving antenna.
- Increase the separation between the equipment and receiver.
- Connect the equipment into an outlet on a circuit different from that to which the receiver is connected.
- Consult the dealer or an experienced radio/TV technician for help.

This device complies with Part 15 of the FCC Rules. Operation is subject to the following two conditions:

- (1) This device may not cause harmful interference, and
- (2) This device may accept any interference received, including interference that may cause undesired operation.

Caution: Any changes or modifications not expressly approved by the party responsible for compliance could void the user's authority to operate the equipment.



More update, please visit www.draytek.com.

USA Local Representative	Company name	ABP International Inc.			
	Address	13988 Diplomat Drive Suite 180 Dallas TX 75234			
	ZIP Code	75234	E-mail	henry@abptech.com	
	Contact Person	Mr. Henry N Castillo	Tel.	(972)831-1600 140	

Be a Registered Owner

Web registration is preferred. You can register your Vigor switch via <https://myvigor.draytek.com>.

Firmware & Tools Updates

Due to the continuous evolution of DrayTek technology, all switches will be regularly upgraded. Please consult the DrayTek web site for more information on newest firmware, tools and documents. <https://www.draytek.com>

1. Package Content



VigorSwitch PQ2300xb (with PoE)



VigorSwitch Q2300x (without PoE)

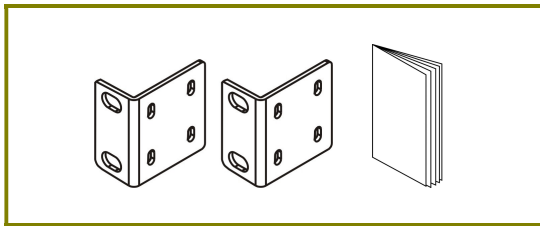

Rack Mount Kit (brackets) & Quick Start Guide

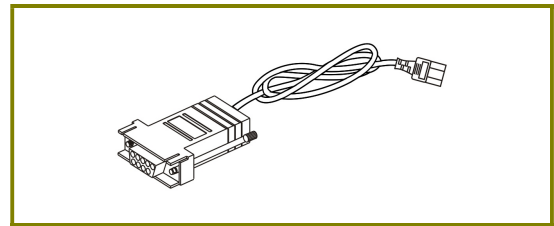

Console Cable

The type of the power cord depends on the country that the switch will be installed.

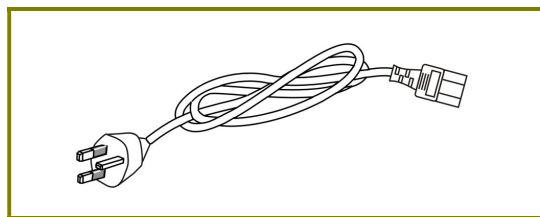

UK-type Power Cord

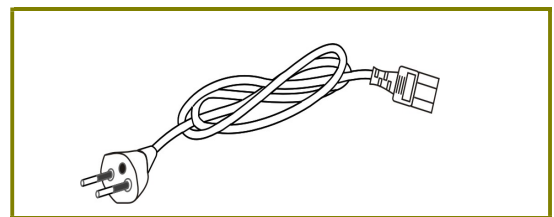

EU-type Power Cord

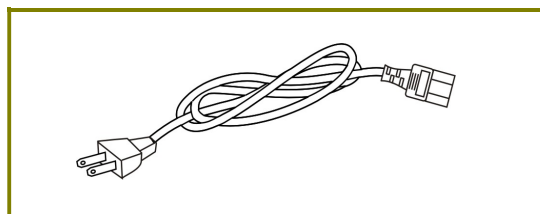

USA/Taiwan-type Power Cord

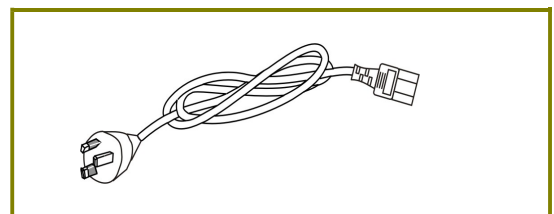

AU/NZ-type Power Cord

If any of these items is found missing or damaged, please contact your local supplier for replacement.

2. Panel Explanation

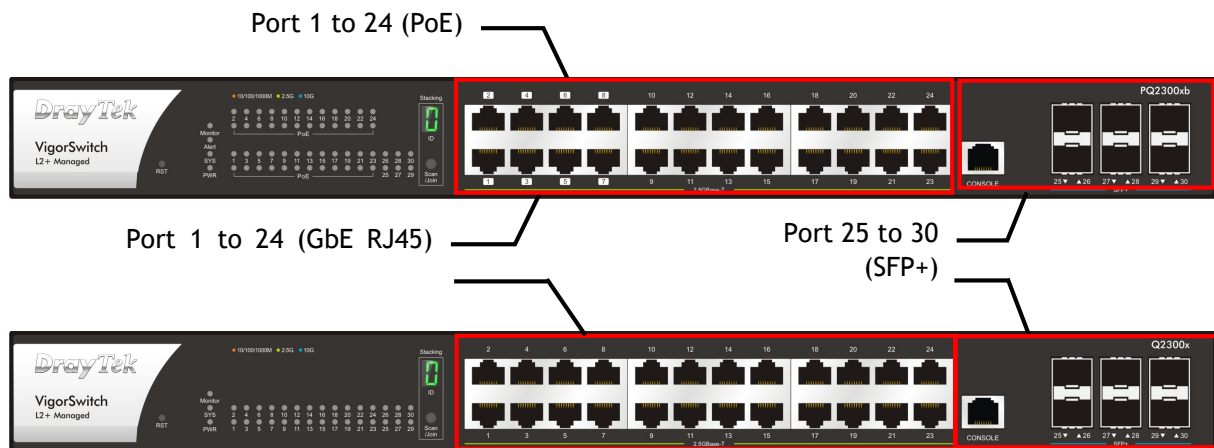

LED	Status	Explanation
Monitor	On (Red)	An alert for system failure due to overheating or wrong voltage.
	Off	The device is in normal condition and running normally.
Alert (for PQ2300xb)	Blinking (Green)	The power is over (>) 80% watts PoE power budget.
	Off	The power is under (<) 80% watts PoE power budget.
SYS	On (Green)	The switch finishes system booting and the system is ready.
	Blinking (Green)	The switch is powered on and starts system booting.
	Off	The power is off or the system is not ready / malfunctioning.
PWR	On (Green)	The device is powered on and running normally.
	Off	The device is not ready or is failed.
Port 1 ~ 24 (PoE, for PQ2300xb)	On (Green)	The port is supplied with PoE power.
	Off	No PoE power is supplied on the port.
Port 1 ~ 24 (GbE RJ45)	On (Green)	The device is connected with 2.5Gbps.
	On (Amber)	The device is connected with 1G/100M/10Mbps.
	Blinking	The system is sending or receiving data through the port.
	Off	The port is disconnected or the link is failed.
Port 25 ~30 (SFP+)	On (Amber)	The device is connected with 1Gbps.
	On (Blue)	The device is connected with 10Gbps.
	Blinking	The system is sending or receiving data through the port.

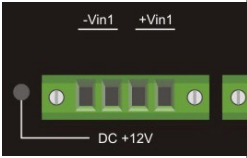
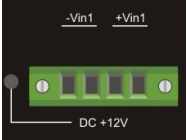
	Off	The port is disconnected or the link is failed.
	0	The switch is in the master mode of stacking.
	1	The switch is in slave mode or provided the highest priority. It serves more than 2 stacking members as the "Secondary Master".
	2 to F	The switch is in the slave mode of stacking.
	r	The switch does not join the stacking members or joins but over the number of members.
	Off	The device is in stand alone mode.
 DC Power In (PQ2300xb)	On (Green)	DC+12V (Vin1) - The power supply with +12VDC is good. DC+54V (Vin2) - The power supply with +54VDC is good.
	Off	The device is not ready or is failed.
 DC Power In (Q2300x)	On (Green)	DC+12V (Vin1) - The power supply with +12VDC is good.
	Off	The device is not ready or is failed.

Interface	Description
RST	Factory reset button. Press it to reboot the system. (<5 seconds) Press it to reset the system with factory default settings. (>5 seconds)
	Stacking scan button. Press the Scan/Join button to auto-scan the join stacking members.
Port 1 ~ 24 (2.5GbE RJ45)	Port 1 to Port 24 can be used for Ethernet connection and PoE connection, depending on the device connected.
Port 1 ~ 8 (PoE 802.3af/at/bt, for PQ2300xb)	
Port 9 ~ 24 (PoE 802.3af/at, for PQ2300xb)	
Port 25 ~ 30 (SFP+)	Port 25 to Port 30 are used for fiber connection.
Console	Used to perform telnet command control.

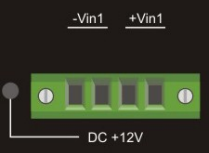
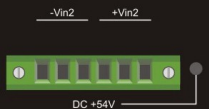

Interface	Description	
	Power inlet for AC input (100-240V/AC, 50/60Hz).	
	DC power in for power failover (System power)	Q2300x: +12VDC/5A (Vin) PQ2300xb: +12VDC/5A (Vin1)
	DC power in for power failover (PoE power)	PQ2300xb: +54VDC/7.41A (Vin2)



Note

The following limitation is suitable for VigorSwitch PQ2300xb
Power Output --

- IEEE 802.3af Max. 15.4W Output Supported
- IEEE 802.3at Max. 30W Output Supported
- IEEE 802.3bt Max. 90W Output Supported (for Port 1~8 only)

PoE Power Budget --

- 400 Watts (Max)

3. Hardware Installation

Before starting to configure the switch, you have to connect your devices correctly.

3.1 Network Connection

Allowance for connecting Non-PoE devices and PoE devices

- Use a Cat. 5e twisted-pair cable to connect a PoE device to the port (1~24) of this switch.
- The switch will supply power to PoE Device over the twisted-pair cable.
- Please note that Power Device must comply with IEEE 802.3af/at/bt.
- Other PCs, servers and network devices can be connected to the switch using a standard 'straight through' twisted pair cable.

Here, we take VigorSwitch PQ2300xb as an example.

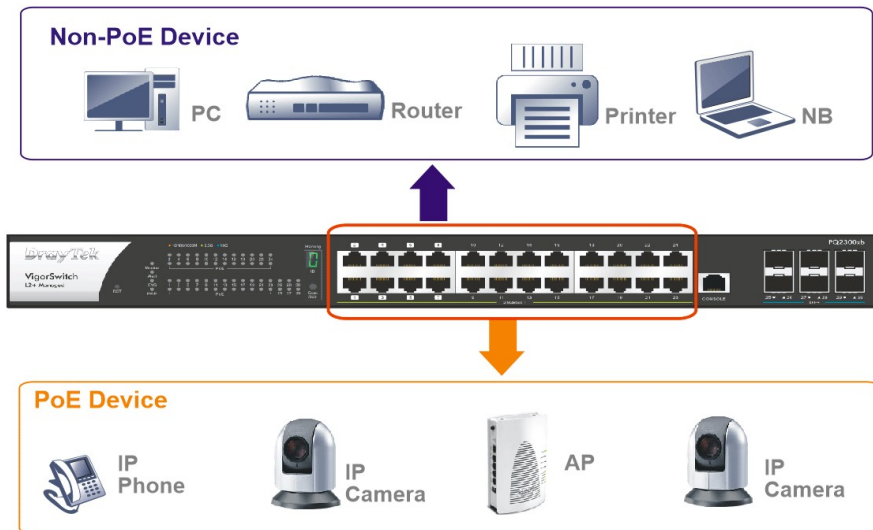

Allowance for connecting Non-PoE devices

- Use the Ethernet cable(s) to connect None-PoE devices to the Vigor switch.
- All device ports are in the same local area network.

Here, we take VigorSwitch Q2300x as an example.

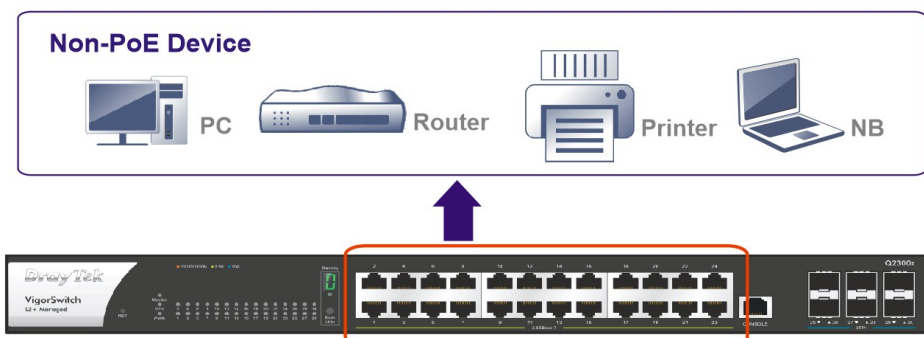

3.2 Rack-Mounted Installation

The switch can be installed easily by using **rack mount kit**.

1. Attach the brackets to the chassis of a 19-inch rack. The second bracket attaches the other side of the chassis as above procedure.

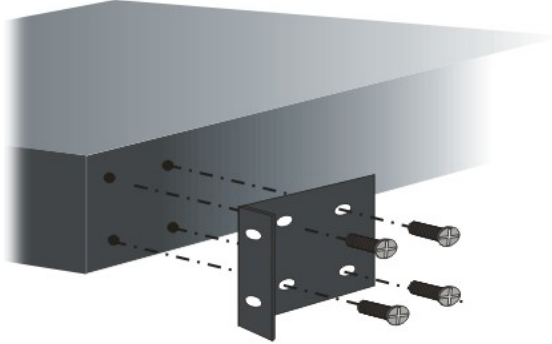

2. After the bracket installation, the VigorSwitch's chassis can be installed in a rack by using four screws for each side of the rack.

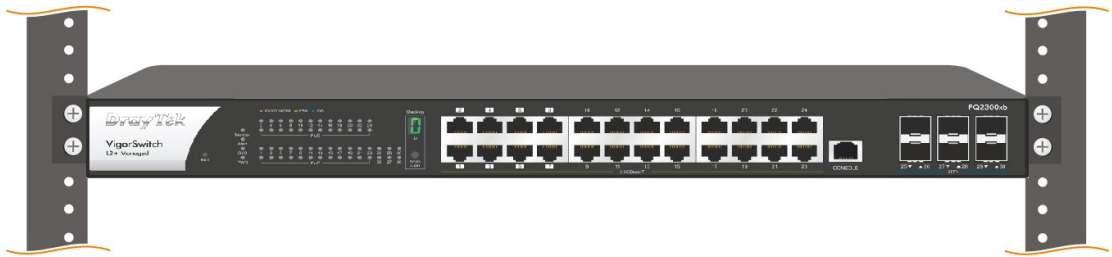

Here, we take VigorSwitch PQ2300xb as an example.

4. Software Configuration

In this section, we take VigorSwitch PQ2300xb as an example.

VigorSwitch, for example:
IP Address: 192.168.1.224
Subnet Mask: 255.255.255.0
Default Gateway: 192.168.1.254

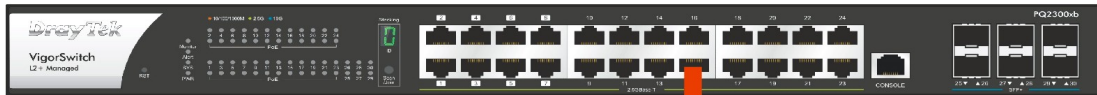

Assign a reasonable IP address, for example:
IP Address: 192.168.1.100
Subnet Mask: 255.255.255.0
Default Gateway: 192.168.1.254



Ethernet LAN

Before using the switch, perform the following steps:

1. Set up a physical path between the configured the switch and a PC by a qualified UTP Cat. 5e cable with RJ-45 connector.
2. If a PC directly connects to the switch, you have to setup the same subnet mask for PC and the switch. Default values of the managed switch are listed as follows:

IP Address	192.168.1.224
Subnet Mask	255.255.255.0
DHCP Client	Enabled (On)
Username	admin
Password	admin

3. After configuring correct IP address on your PC, open your web browser and access switch's IP address.
4. Please enter "admin/admin" as the Username/Password and click **Login**.

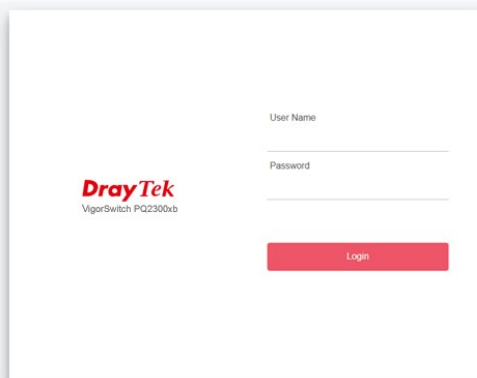

5. Next, a page will appear to guide you change the login password. You **MUST** change the login password before accessing the web user interface. Please click **OK**.

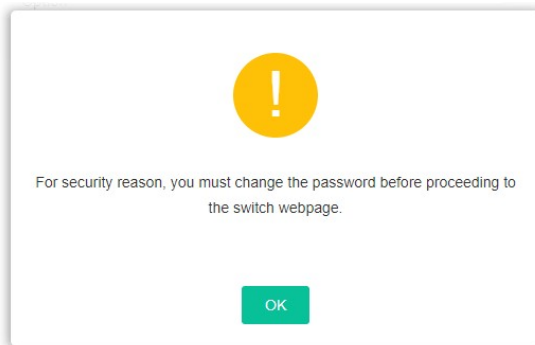

6. Please set a new password with the highest level of strength for network security.

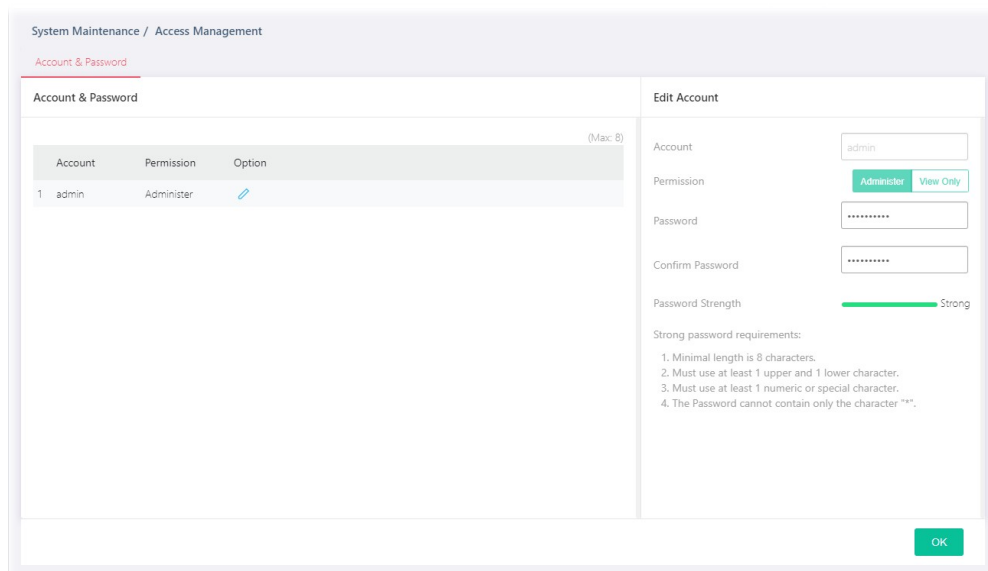

7. Click **OK**. Vigor system will guide you to login with the new password again. Enter the new Username/Password and click **Login**.

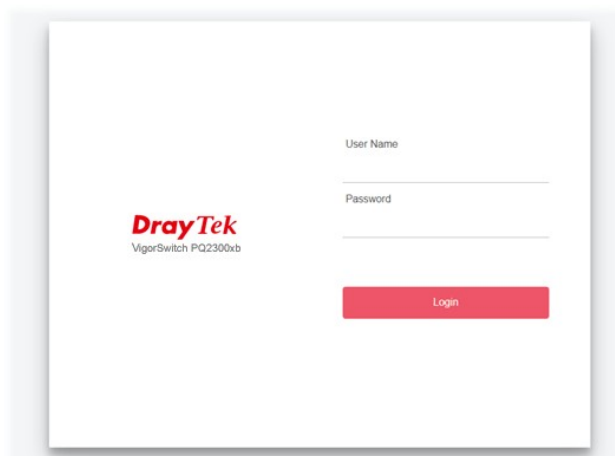

8. Later, the home page of VigorSwitch will be shown on the screen.

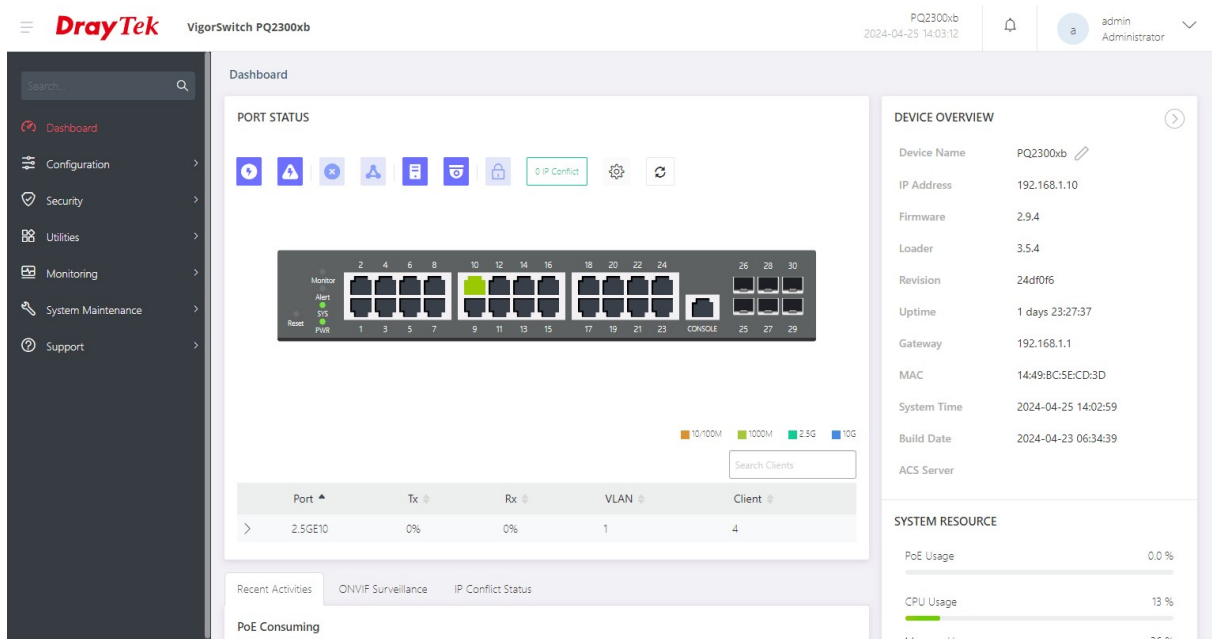

Customer Service

If the switch cannot work correctly after trying many efforts, please contact your dealer for further help right away. For any questions, please feel free to send e-mail to support@draytek.com.

GPL Notice

This DrayTek product uses software partially or completely licensed under the terms of the GNU GENERAL PUBLIC LICENSE. The author of the software does not provide any warranty. A Limited Warranty is offered on DrayTek products. This Limited Warranty does not cover any software applications or programs.

To download source codes please visit:

<http://gplsource.draytek.com>

GNU GENERAL PUBLIC LICENSE:

<https://gnu.org/licenses/gpl-2.0>

Version 2, June 1991

For any question, please feel free to contact DrayTek technical support at support@draytek.com for further information.