

---

## MR28 Installation Guide

The Cisco Meraki MR28 is a dual-band enterprise Wi-Fi 6 cloud-managed access point.

---

## Package Contents

The MR28 package contains the following:

- MR28 Cloud-Managed Access Point



- Mount plate

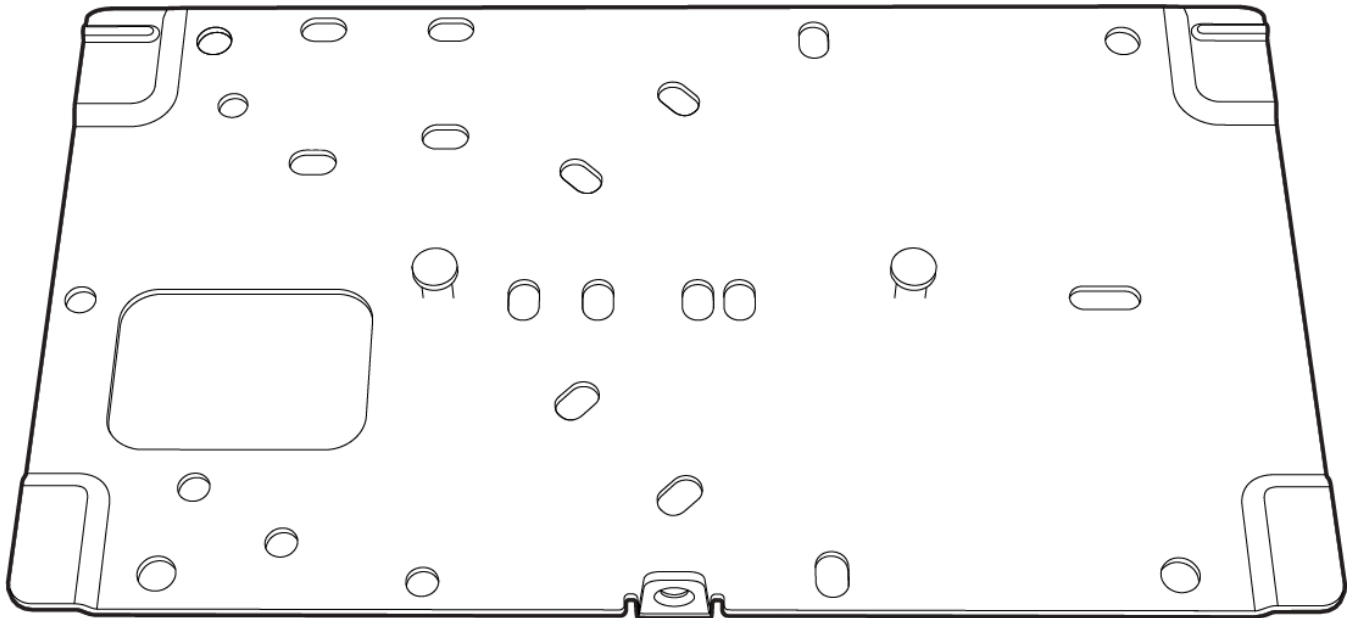

- Mount Kit
  - Wall screws, wall screw anchors, and security screws

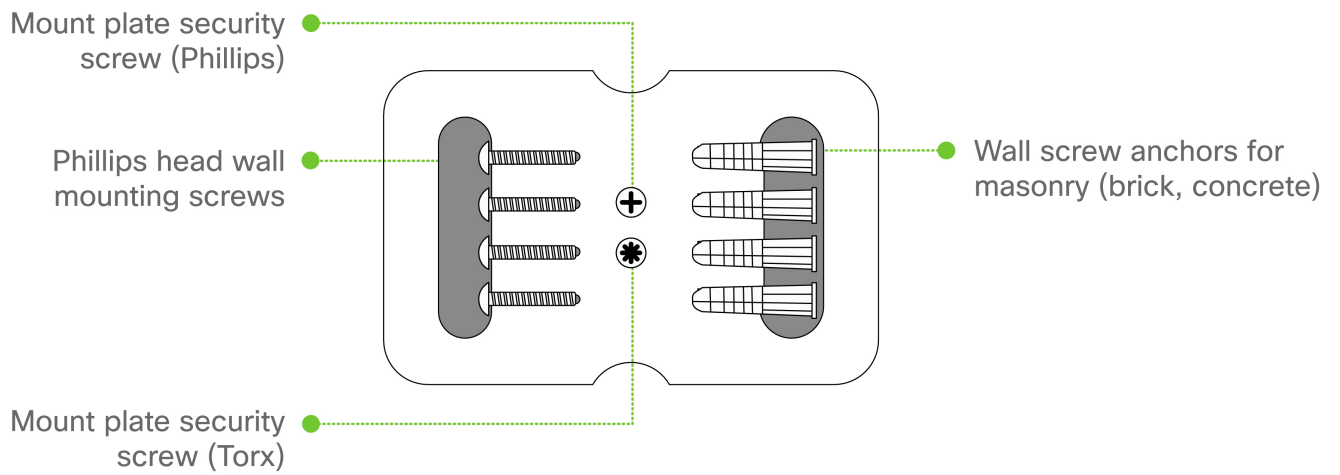

---

## Understanding the MR28

Your Meraki MR28 has the following features:

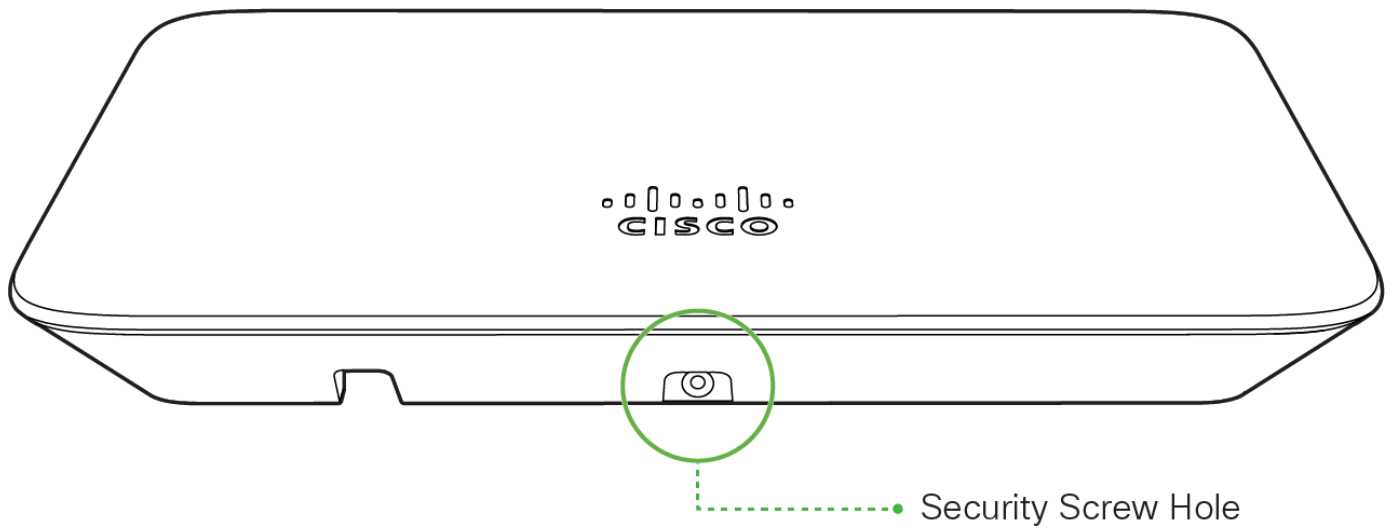

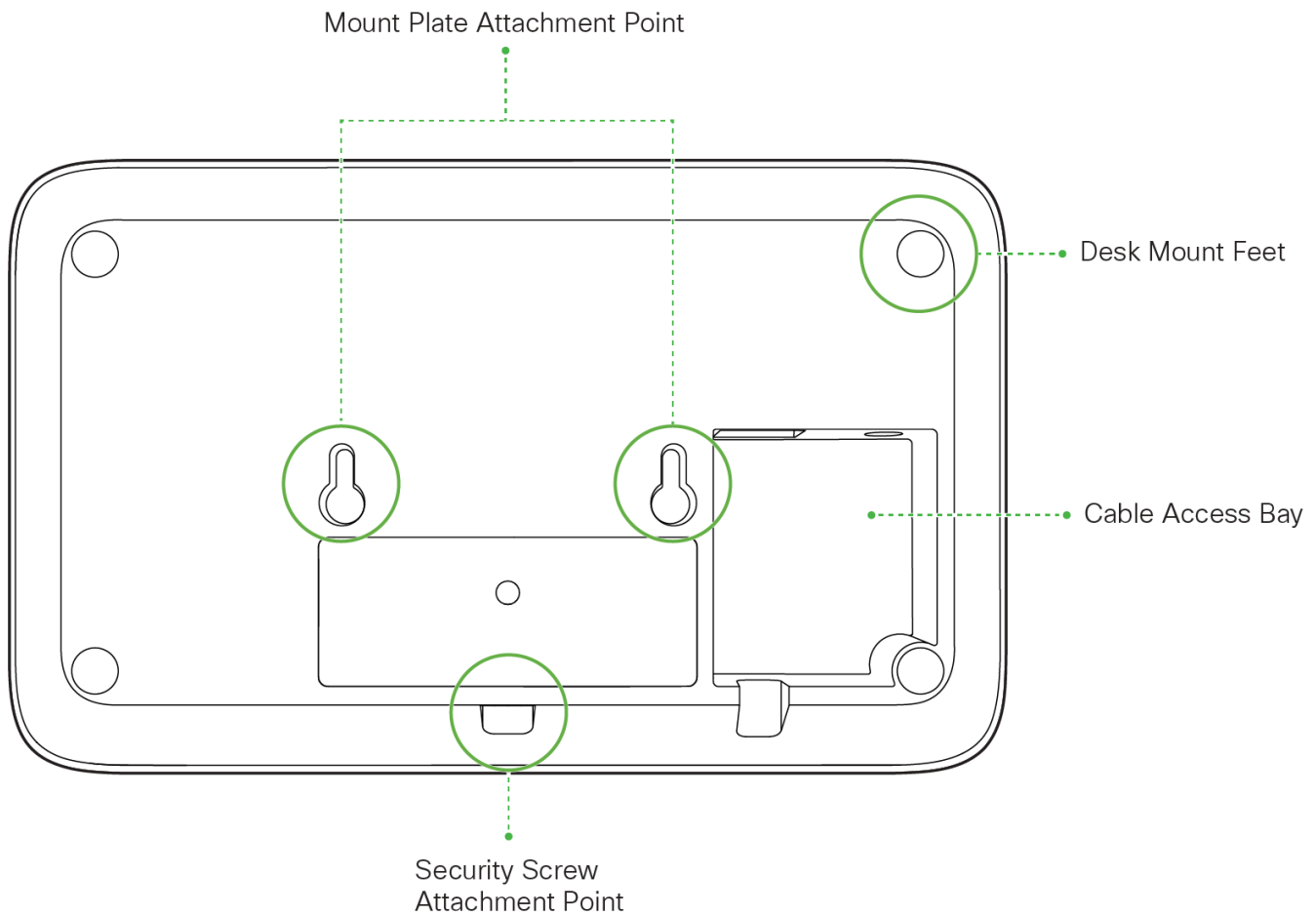

The mount plate has the following features:

---

## Security Features

The MR28 features multiple options for physically securing the access point after installation:

1. **Security screw** – The accessory kit includes screws that can be used to secure the access point to the mount cradle. Engaging the security screw prevents accidental dislodging and theft.

---

## Ethernet Ports

The MR28 features a Gigabit Ethernet RJ45 port that accepts 802.3at and 802.3af power (labeled “Eth0, PoE”). This port should be used for uplink to your WAN connection.

---

## Power Source Options

The MR28 access point can be powered using either the Meraki AC Adapter, PoE Injector (both sold separately), or a third-party PoE switch. The MR28 operates at full power with 802.3af PoE.

---

## Factory Reset Button

If the button is pressed and held for at least five seconds and then released, the MR28 will reboot and be restored to its original factory settings by deleting all configuration information stored on the unit.

---

## LED Indicators and Run Dark Mode

Your MR28 is equipped with a multi-color LED light on the front of the unit to convey information about system functionality and performance:

- Orange - AP is booting (permanent Orange suggests hardware issue)
- Rainbow - AP is initializing/scanning
- Blinking Blue - AP is upgrading
- Green - AP in Gateway mode with no clients
- Blue - AP in Gateway mode with clients
- Blinking Orange - AP can't find uplink

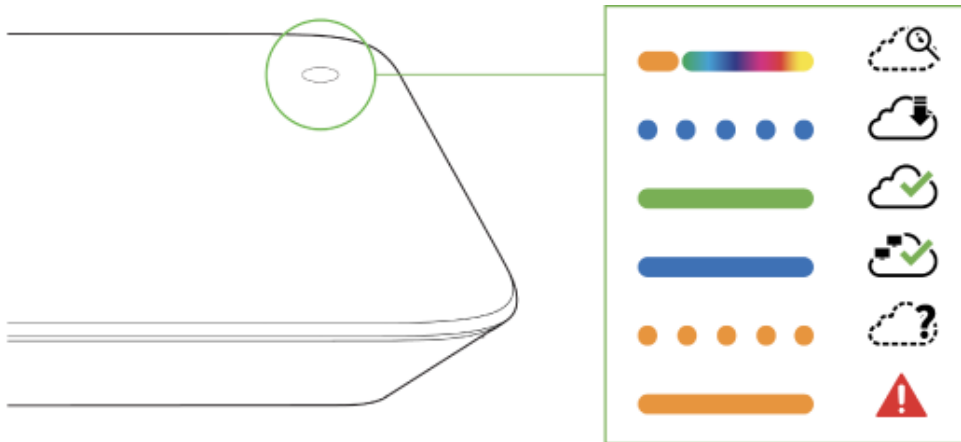

 [dashboard.meraki.com](https://dashboard.meraki.com)    [docs.meraki.com/mr](https://docs.meraki.com/mr)

The MR28 may be operated in "Run Dark" mode for additional security and to reduce the visibility of the access point. In this mode, the LED will not be illuminated. This mode may be enabled through Meraki dashboard.

 **NOTE:** Blinking Green LED indicates that the device is in site survey mode. Please see the Conducting Site Surveys with MR Access Points for more details.

---

## Pre-Install Preparation

You should complete the following steps before going on-site to perform an installation.

---

## Configure Your Network in Dashboard

The following is a brief overview only of the steps required to add an MR28 to your network. For detailed instructions about creating, configuring and managing Meraki wireless networks, refer to the online documentation ([documentation.meraki.com](http://documentation.meraki.com)).

1. Login to <http://dashboard.meraki.com>. If this is your first time, create a new account.
2. Find the network to which you plan to add your APs or create a new network.
3. Add your APs to your network. You will need your Meraki order number (found on your invoice) or the serial number of each AP, which looks like Qxxx-xxxx-xxxx, and is found on the bottom of the unit. You will also need your Enterprise license key, which you should have received via email.
4. Go to the map / floor plan view and place each AP on the map by clicking and dragging it to the location where you plan to mount it.

---

## Check and Upgrade Firmware

To ensure your MR28 performs optimally immediately following installation, it is recommended that you facilitate a firmware upgrade prior to mounting your MR28.

1. Attach your MR28 to power and a wired Internet connection. See the "Power the MR28" section for details.
2. The MR28 will turn on and the LED will glow solid orange. If the unit does not require a firmware upgrade, the LED will turn either green (no clients associated) or blue (clients associated) within thirty seconds.

\* If the unit requires an upgrade, the LED will begin blinking orange until the upgrade is complete, at which point the LED will turn solid green or blue. You should allow at least a few minutes for the firmware upgrade to complete, depending on the speed of your internet connection.

---

## Check and Configure Firewall Settings

If a firewall is in place, it must allow outgoing connections on particular ports to particular IP addresses. The most current list of outbound ports and IP addresses for your particular organization can be found [here](#).

---

## Assigning IP Addresses to MR28s

All gateway MR28s (MR28s with Ethernet connections to the LAN) must be assigned routable IP addresses. These IP addresses can be dynamically assigned via DHCP or statically assigned.

### Dynamic Assignment

When using DHCP, the DHCP server should be configured to assign a static IP address for each MAC address belonging to a Meraki AP. Other features of the wireless network, such as 802.1X authentication, may rely on the property that the APs have static IP addresses.

### Static Assignment

Static IPs are assigned using the local web server on each AP. The following procedure describes how to set the static IP:

1. Using a client machine (e.g., a laptop), connect to the AP wirelessly (by associating to any SSID broadcast by the AP) or over a wired connection.

2. If using a wired connection, connect the client machine to the MR28 either through a PoE switch or a PoE Injector. If using a PoE switch, plug an Ethernet cable into the MR28's Ethernet jack, and the other end into a PoE switch. Then connect the client machine over Ethernet cable to the PoE switch. If using a PoE Injector, connect the MR28 to the "PoE" port of the Injector, and the client machine to the "LAN" port.
3. Using a web browser on the client machine, access the AP's built-in web server by browsing to <http://my.meraki.com>. Alternatively, browse to <http://10.128.128.128>.
4. Click on the "Uplink Configuration" tab. Log in. The default login is the serial number (e.g. Qxxx-xxxx-xxxx), with no password (e.g., Q2DD-551C-ZYW3).
5. Configure the static IP address, net mask, gateway IP address and DNS servers that this AP will use on its wired connection.
6. If necessary, reconnect the AP to the LAN.

## Static IP via DHCP Reservations

Instead of associating to each Meraki AP individually to configure static IP addresses, an administrator can assign static IP addresses on the upstream DHCP server. Through "DHCP reservations," IP addresses are "reserved" for the MAC addresses of the Meraki APs. Please consult the documentation for the DHCP server to configure DHCP reservations.

---

## Collect Tools

You will need the following tools to perform an installation:



T8 Torx  
screwdriver



Phillips  
screwdriver



Hammer

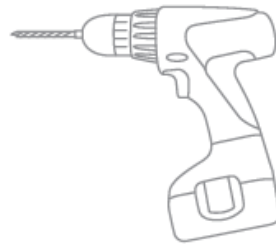

Drill with 1/4"  
(6.3mm) bits

---

## Collect Additional Hardware for Installation

You will need the following hardware to perform an installation:



802.3at PoE power source (either PoE switch or Meraki 802.3at PoE Injector)

or

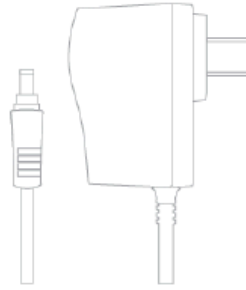

AC Adapter



Network cables with RJ45 connectors long enough for your particular mounting location

---

## Installation Instructions



**Warning:** Due to the heat dissipation in the back of APs during normal operation, please do not stack powered on APs on top of each other during pre-installation to avoid heat damage.

---

## Choose Your Mounting Location

A good mounting location is important to getting the best performance out of your MR28 access point. Keep the following in mind:

1. The device should have unobstructed line of sight to most coverage areas. For example, if installing in an office filled with workspaces divided by mid-height cubicle walls, installing on the ceiling or high on a wall would be ideal.
2. Power over Ethernet supports a maximum cable length of 300 ft (100 m).
3. If being used in a mesh deployment, the MR28 should have line of sight to at least two other Meraki devices. A Cisco Partner can help ensure that your AP placement is ideal.

---

## Power the MR28

If mounting to an electrical junction box, feed the Ethernet cable through the cable access hole in the mount cradle. If mounting to a wall or ceiling, the Ethernet cable will feed from behind the MR28. The "[Power Source Options](#)" section of this document lists the different powering options and their unique characteristics.

---

## Mount the MR28

---

### Attach the MR28 to the Mount Cradle

(This section applies to wall and/or solid ceiling, drop ceiling or electrical junction box mount where you have already installed the mount cradle.)

The MR28 attaches to the mount cradle with two tabs on the cradle that insert into the MR28, and is secured to the cradle using one screw.

To attach the MR28 to the mount cradle properly, line up the top edge of the AP with the top tab of the mount cradle. Since the cradle is already mounted to the wall, guide the MR28 towards the top tab and insert the top tab into the MR28's slot.

Then adjust the MR28 to guide the MR28's bottom slot into the cradle's bottom tab until it clicks into place. Once in place, the MR28 should be secured to the cradle by using one of the included screws in the cradle's bottom tab.

1

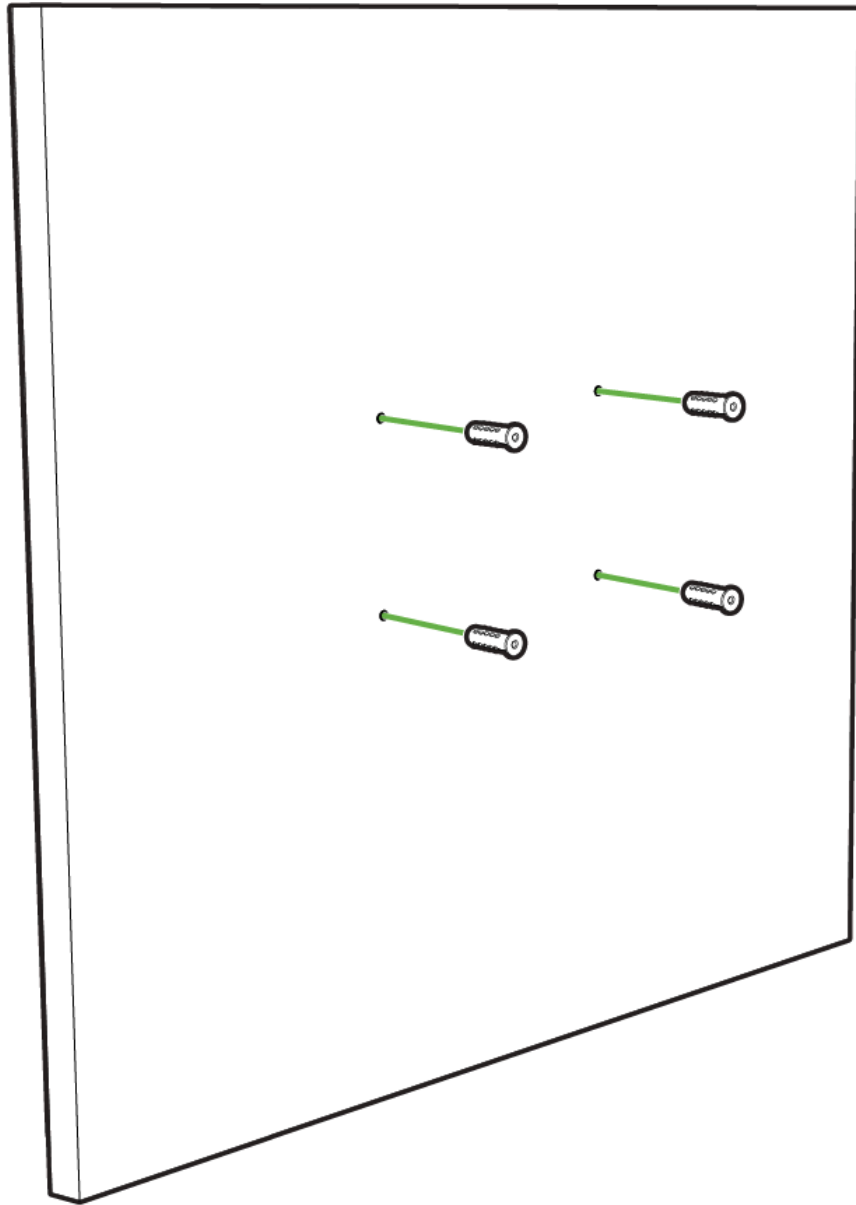

2

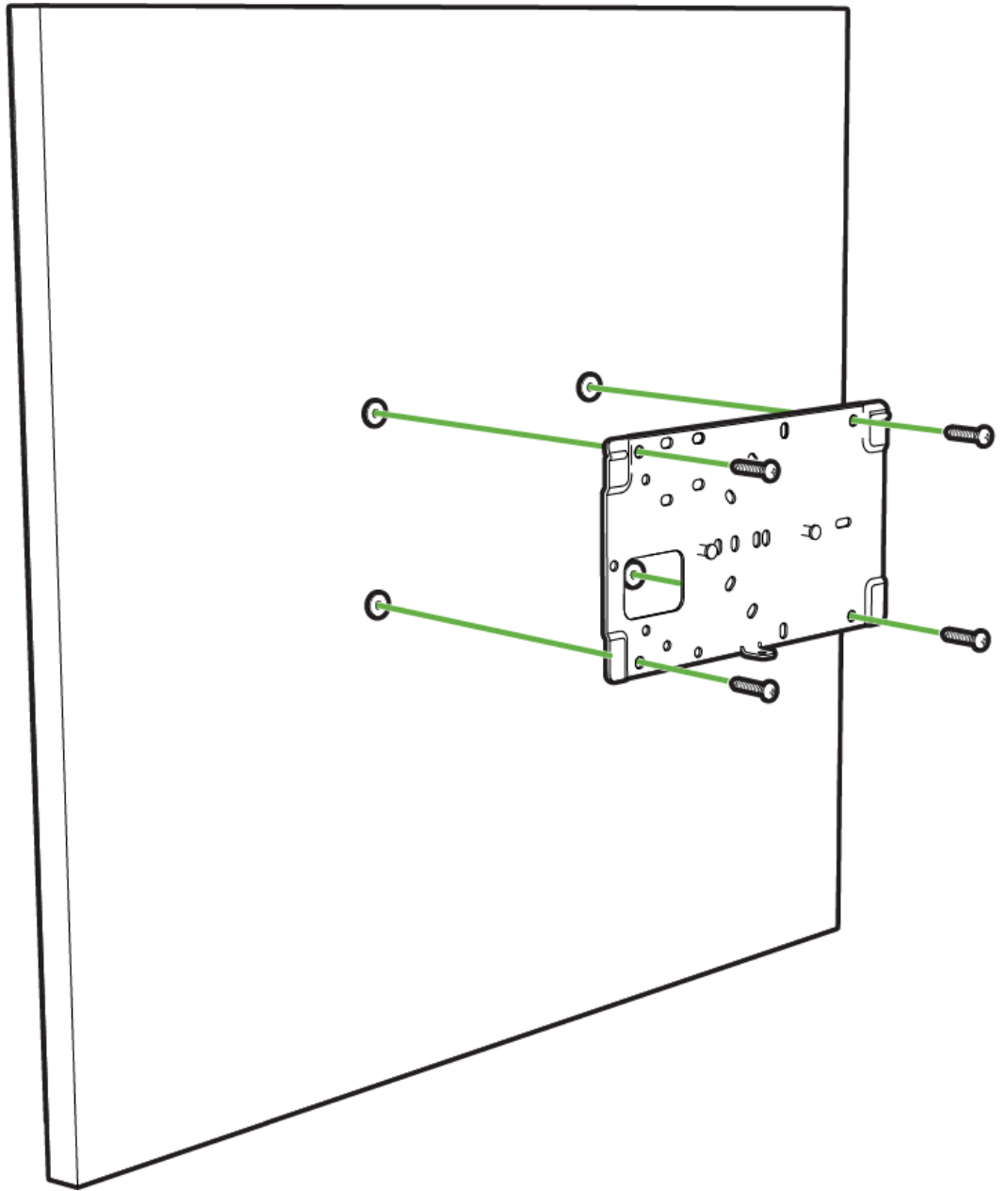

3

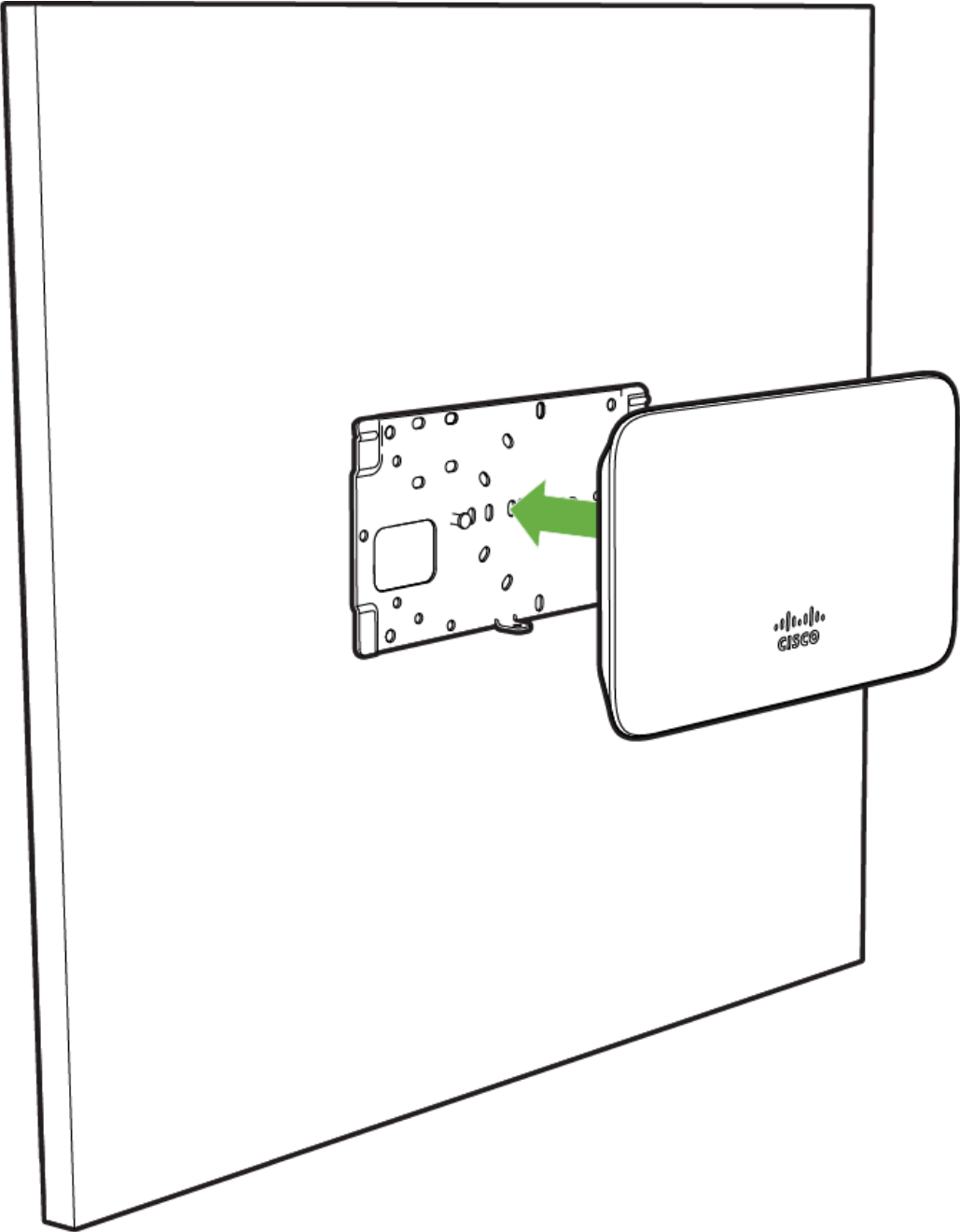

4

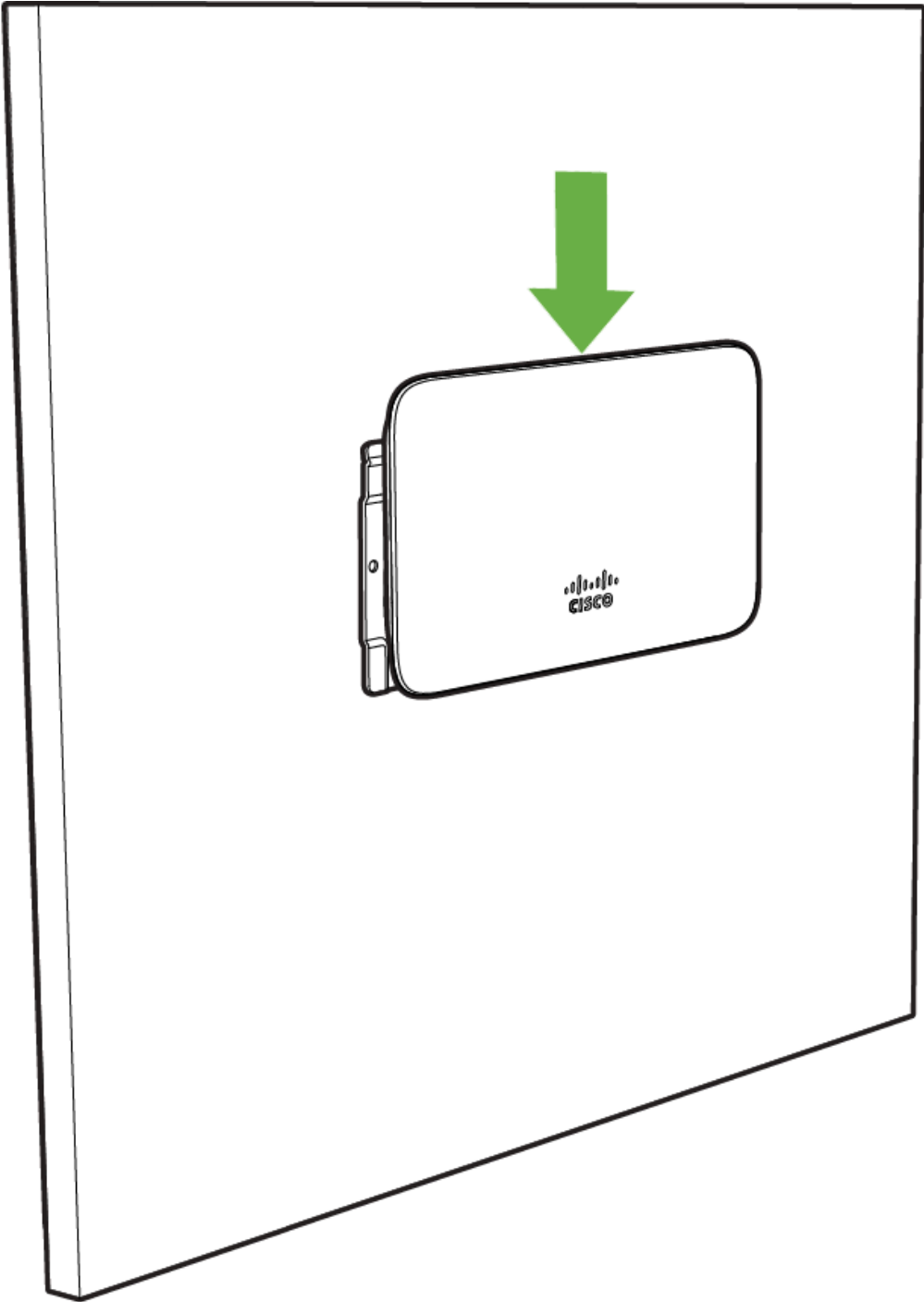

5

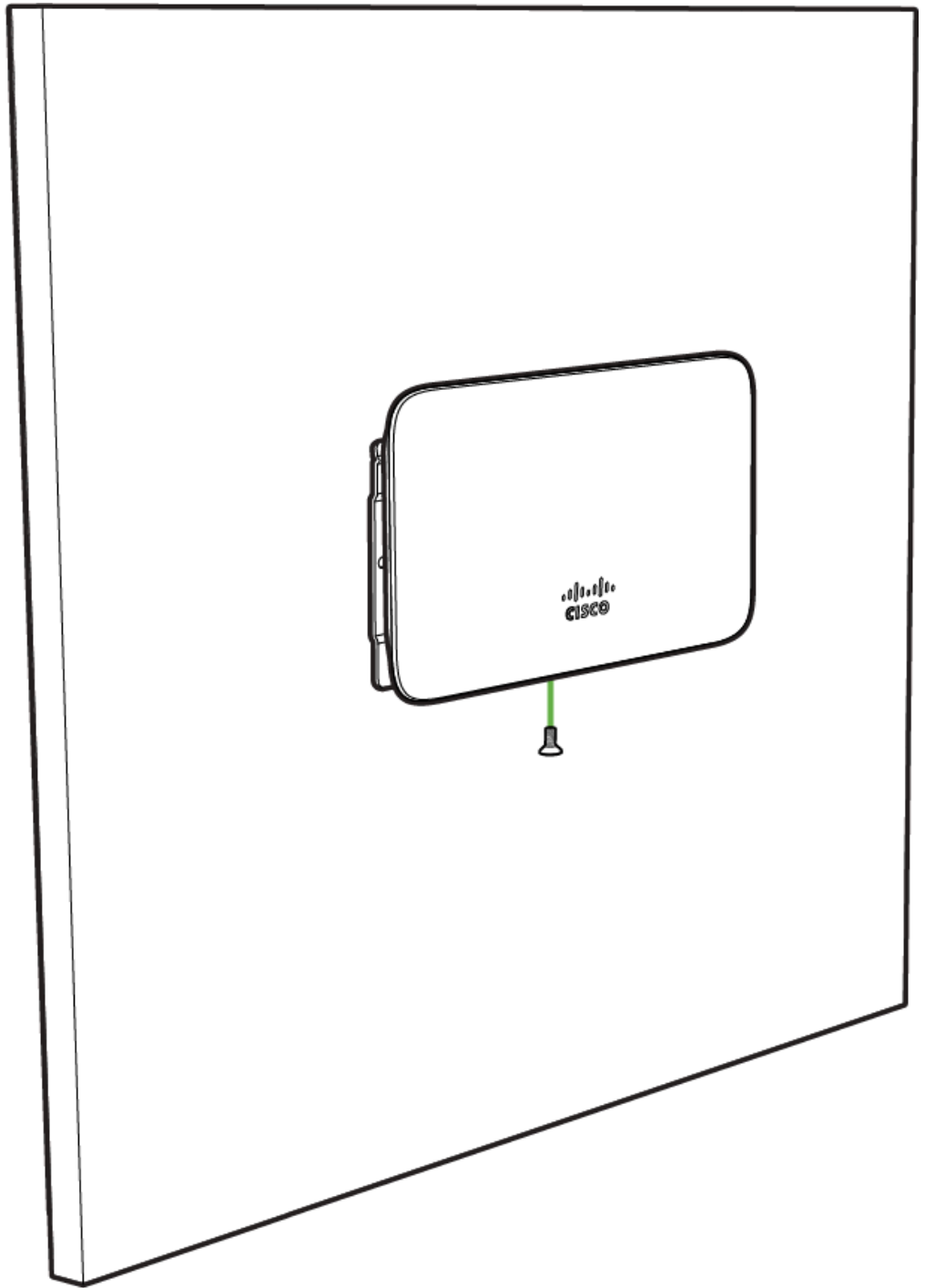

6

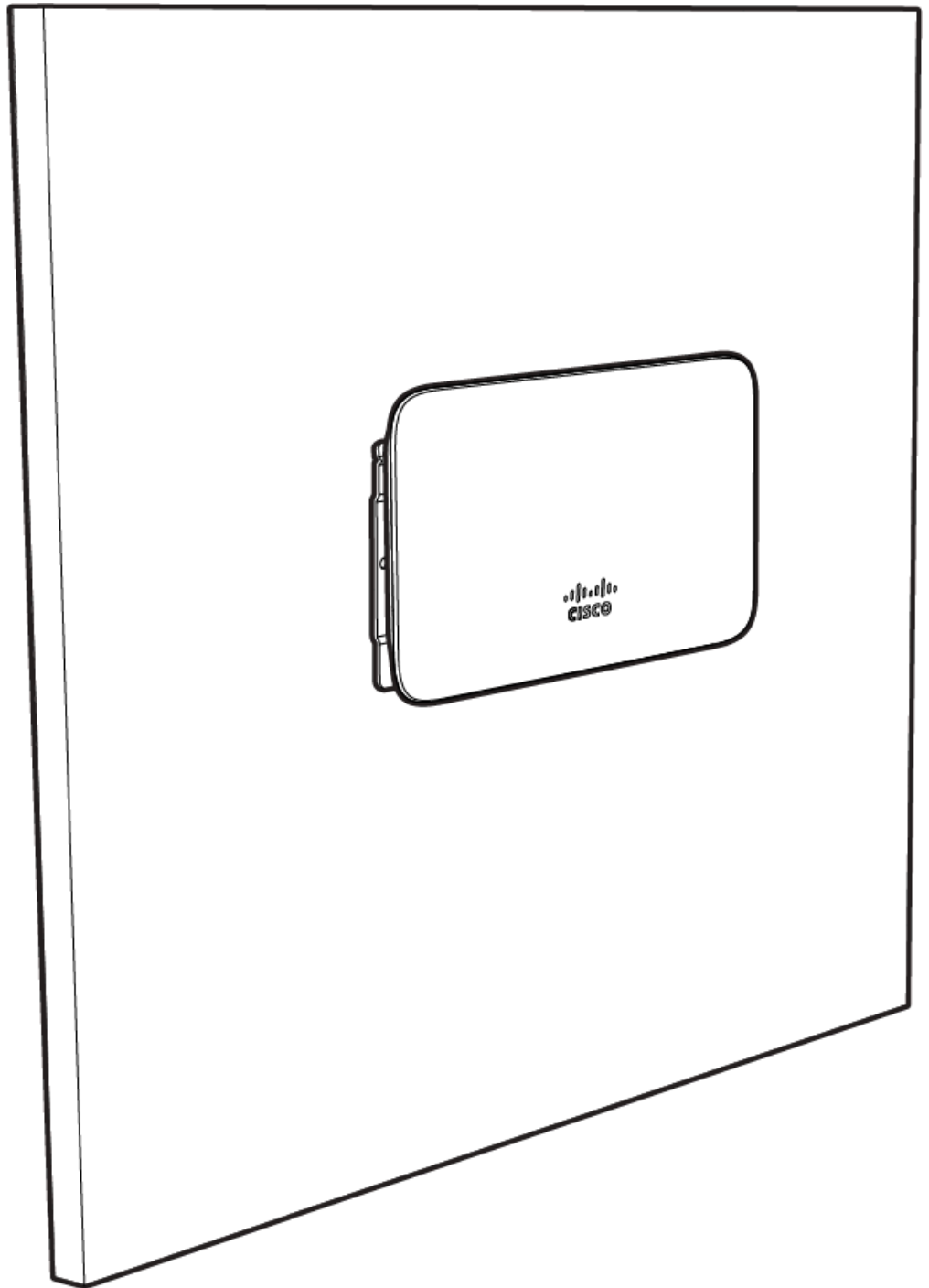

To release the MR28 from the mount cradle, first remove the security screw that secures the MR28 to the cradle's bottom tab. While holding the MR28 with one hand, press the cradle's bottom tab upwards, releasing the MR28 from the bottom of the cradle. Then remove the MR28 from the cradle's top tab.

## Desk or Shelf Mount

The MR28 can be placed on a desk or shelf resting on the non-scratch rubber feet. The mount cradle is not necessary for a desk or shelf installation.

---

## Secure the MR28

Depending on your mounting environment, you may want to secure the MR28 to its mount location. If the MR28 has been installed using the mount cradle, it should be secured via security screw (Torx security screws are included).

---

## Power the MR28

If mounting to an electrical junction box, feed the Ethernet cable through the cable access hole in the mount cradle. If mounting to a wall or ceiling, the Ethernet cable will feed from behind the MR28. The "[Power Source Options](#)" section of this document lists the different powering options and their unique characteristics.

---

## Verify Device Functionality and Test Network Coverage

1. Check LEDs
    - a. The Power LED should be solid green (or blue, if clients are connected). If it is flashing blue, the firmware is automatically upgrading and the LED should turn green when the upgrade is completed (normally within a few minutes). See the "[LED Indicators](#)" section for more details. .
    - b. Note: Your MR28 must have an active route to the Internet to check and upgrade its firmware.
  2. Verify access point connectivity
    - a. Use any 802.11 client device to connect to the MR28 and verify proper connectivity using the client's web browser.
  3. Check network coverage
  4. Confirm that you have good signal strength throughout your coverage area. You can use the signal strength meter on a laptop, smart phone, or other wireless device.
- 

## Troubleshooting

Reference the [MR Product Page](#) for additional information and troubleshooting tips.

---