



Poly TC10 User Guide 4.1.0

SUMMARY

This guide helps you understand how to use your Poly TC10 device.

Table of contents

1 Before You Begin	1
Audience, Purpose, and Required Skills.....	1
Product Terminology Used in This Guide	1
2 Getting Started	2
Poly Controller Overview.....	2
Poly TC10 in Poly Video Mode as a Room Controller	2
Poly TC10 in Zoom Rooms Mode.....	3
Zoom Rooms Mode as a Room Controller	3
Zoom Rooms Mode as a Room Scheduler.....	3
Poly TC10 in Microsoft Teams Controller Mode	4
Poly TC10 Hardware Overview.....	4
Poly TC10 Local Interface.....	5
Poly TC10 Status Bars.....	5
Home Screen in Poly Video Mode	6
Access the Poly Control Center	7
Waking the Poly TC10	7
Accessibility Features	7
Users Who Are Deaf or Hard of Hearing	7
Users Who Are Blind, Have Low Vision, or Have Limited Vision.....	8
Users with Limited Mobility	8
3 Using the Poly TC10 in Poly Video Mode	9
Calling	9
Placing Calls	9
Place a Call.....	9
Answer a Call.....	10
Ignore a Call	10
End a Call	10
Calling Contacts.....	10
Call a Contact	10
Call a Recent Contact.....	11
Calling Favorite Contacts.....	11
Favorite a Contact	11
Unfavorite a Contact.....	11
Call a Favorite Contact	11
Joining Meetings from the Calendar	11

Meeting Cards	11
View Meeting Cards	12
Join a Meeting from a Meeting Card	12
Join an Overbooked Meeting	12
Join a Password-Protected Meeting	12
Sharing Content	13
Minimize Content	13
Maximize Content	13
Take a Snapshot of Your Content	13
Delete Snapshots or Content	13
End a Call with Blackboard or Whiteboard Content	14
Cameras	14
Adjust an In-Room Camera	14
Adjust a Far-Site Camera	14
Turn Your Camera On or Off	15
Turn Camera Tracking On or Off	15
Selecting the Primary Camera	15
Camera Priority	15
Select the Primary Camera Using the Poly TC10	15
Using Camera Presets	16
Save a Camera Preset Using the Poly TC10	16
Select a Preset	16
Delete a Preset	16
Environment Controls	16
Control Room Elements Using the Poly TC10	17
Settings	17
Video Adjustments	17
Change the Participant Layout	17
Audio Adjustments	17
Mute Your Microphones	17
Unmute Your Microphones	18
Adjust the Volume	18
Poly TC10 LED Status Indicators as a Room Controller in Poly Video Mode	18
4 Using the Poly TC10 Touch Controller in Partner Modes	19
Switch Between Zoom Controller and Zoom Scheduler Mode	19
Using the Poly TC10 in Zoom Rooms Controller Mode	19
Start an Instant Meeting in Zoom Rooms	19
Start a Scheduled Meeting in Zoom Rooms	19
Call a Contact in Zoom Rooms	20
Sharing Content in Zoom Rooms from a Poly TC10	20
Sharing Content in Zoom Rooms Using a Sharing Key or Meeting ID	20
Poly TC10 LED Status Indicators in Zoom Rooms Controller Mode	20
Using the Poly TC10 in Zoom Rooms Scheduler Mode	21
Schedule a Meeting on the Zoom Rooms Scheduler	21
Delete a Meeting from the Zoom Rooms Scheduler	21

Disable Instant Room Reservation	22
Poly TC10 LED Status Indicators in Zoom Rooms Scheduler Mode	22
Using the Poly TC10 as a Microsoft Teams Controller	22
Start or Join a Meeting in Microsoft Teams Rooms	22
Call a Contact in Microsoft Teams Rooms.....	23
Manage a Meeting in Microsoft Teams Rooms	23
Poly TC10 LED Status Indicators in Microsoft Teams Rooms Controller Mode	23
5 Device Maintenance.....	24
Unpair the TC10 from a Video System	24
Restart the Poly TC10.....	24
6 Troubleshooting.....	25
View the Poly TC10 and Paired Video System Information	25
Zoom Rooms Pairing Error	25
7 Getting help	26

1 Before You Begin

This guide helps you understand how to set up, manage, and use your Poly TC10 device.

Audience, Purpose, and Required Skills

This guide is intended for beginning-to-intermediate users who participate in video-conferencing calls.

Product Terminology Used in This Guide

Use the following information to help you understand how this guide sometimes refers to Poly products.

Device

Refers to the Poly TC10 device.

Video system

Refers to the Poly G7500 and the Poly Studio X-Series.

System

Another way of referring to the Poly G7500 and the Poly Studio X-Series.

2 Getting Started

The Poly TC10 delivers room scheduling with Zoom Rooms Scheduler, room control with any Poly Partner app or lets you control supported Poly video conferencing systems.

Flexible deployment options provide a range of operating modes that meet different room requirements.

Poly Controller Overview

You can pair the Poly TC10 with a Poly video system. for example, a G7500 system, or use it as a standalone (unpaired) controller.

In paired mode, the Poly TC10:

- Pairs with a Poly video system.
- Supports all Poly partner modes

In standalone mode, the Poly TC10:

- Operates alone; you don't need to pair it with a Poly video system.
- Supports Zoom Rooms Mode, running either Zoom Room Controller or Zoom Rooms Scheduler.

The Poly TC10 works with the following devices in paired mode:

- Poly G7500
- Poly Studio X70
- Poly Studio X50
- Poly Studio X52
- Poly Studio X30

Poly TC10 in Poly Video Mode as a Room Controller

With the Poly TC10, you can control and manage aspects of a Poly video system.

The Poly TC10 must be paired with a video system to operate in Poly Video Mode.

The following features and capabilities are available in Poly Video Mode:

- Placing and joining video calls
- Viewing and joining scheduled calendar meetings
- Managing contacts, call lists, and directories
- Managing shared content
 - Taking snapshots
 - Maximizing, minimizing, and stopping content
- Adjusting camera pan, tilt, zoom and tracking settings
- Creating camera presets
- Adjusting display brightness
- Using multiple Poly TC10 controllers to control a single system
- Pairing with video systems over the network (wired LAN) for flexible room setups

Poly TC10 in Zoom Rooms Mode

Within Zoom Rooms, the Poly TC10 can run either as a Zoom Rooms Controller or a Zoom Rooms Scheduler.

- Zoom Rooms Controller: Positioned inside a conference room, use the Poly TC10 to start and manage meetings, share content, and more.
- Zoom Rooms Scheduler: Mounted outside a meeting room, the Poly TC10 displays the room status and upcoming scheduled meetings, and is used for room reservation.



NOTE: To use Zoom Rooms Controller and Scheduler, you need a Zoom Rooms account. To use all of the functionality of the Zoom Rooms Scheduler, log in to the scheduler with a Zoom Rooms admin account.

Zoom Rooms Mode as a Room Controller

Run Zoom Rooms Controller on the Poly TC10 in a meeting space to launch and manage Zoom meetings.

With Zoom Rooms Controller, you pair the Poly TC10 with a Zoom Room running on a Poly Studio X-Series, codec, or a desktop PC/Mac. The Zoom Room Controller controls the Zoom Room. You can join a scheduled meeting, start an unscheduled meeting, invite participants to a meeting, view upcoming meetings, share content, dial a phone number, and manage all aspects of a Zoom meeting.

Zoom Rooms Mode as a Room Scheduler

Run Zoom Rooms Scheduler on a Poly TC10 mounted outside a meeting room to manage the room. The Poly TC10 displays the current status of the room and any scheduled meetings.

Administrators can sync the following calendars to a Zoom Room:

- Google Calendar
- Office 365

- Microsoft Exchange

Once synced, the calendar meetings for that day appear on the display.

Users can perform the following tasks on a Poly TC10 running Zoom Rooms Scheduler:

- See the current status of the Zoom Room and any upcoming meetings
- Reserve a time slot in the Zoom Room calendar
- Reserve a time slot in another Zoom Room in an integrated floor plan
- Cancel a meeting that a user scheduled through the Zoom Rooms Scheduler

Poly TC10 in Microsoft Teams Controller Mode

In Microsoft Teams mode, the Poly TC10 acts as a touch screen Microsoft Teams controller.

The following features and capabilities are available in Microsoft Teams controller mode:

- Placing and joining video calls
- Viewing and joining scheduled calendar meetings
- Managing contacts, call lists, and directories
- Sharing content

Poly TC10 Hardware Overview

The following illustration and table outline the hardware features of the TC10.

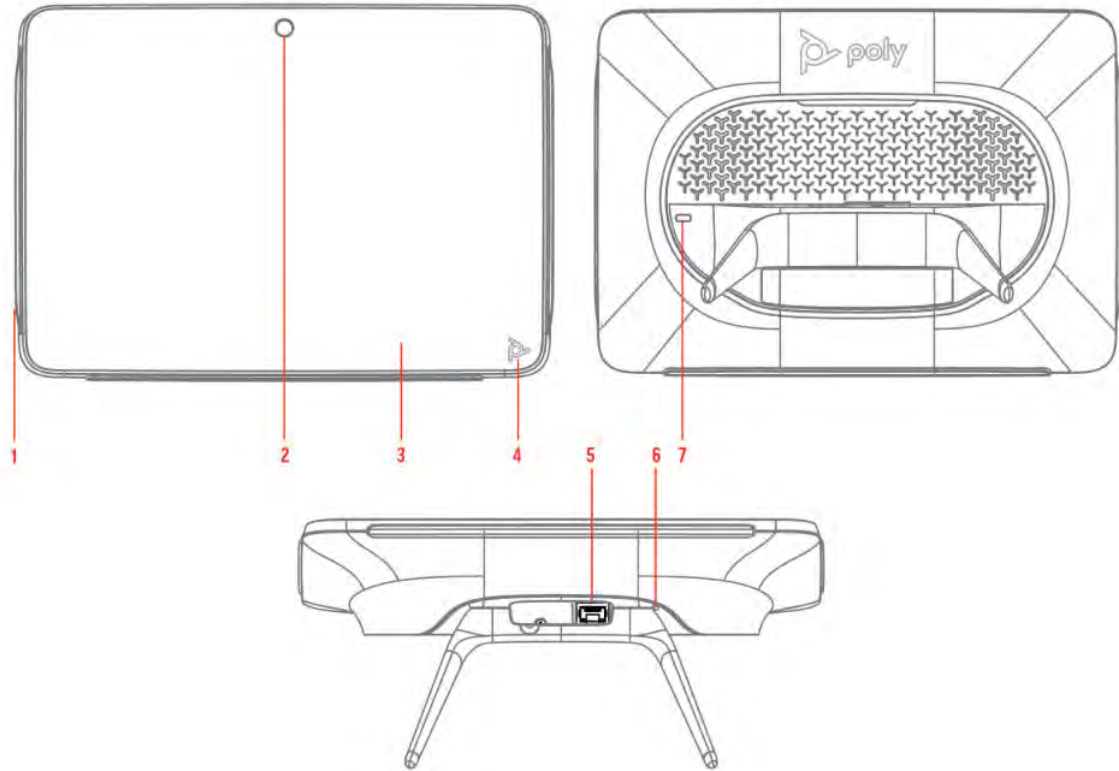

Table 2-1 Poly TC10 Hardware Features

Ref. Number	Description
1	LED bar
2	Motion sensor to wake up display
3	Touchscreen
4	Poly touch button to launch Poly control dock menu
5	LAN connection port
6	Factory restore pinhole
7	Security lock

Poly TC10 Local Interface

The Poly TC10 controller's local interface displays controls and settings available to you depending on the mode you're using.

Poly TC10 Status Bars

The Poly TC10 controller provides two LED bars on the right and left edges of the screen.

These LEDs help you understand the controller's behaviors.

Home Screen in Poly Video Mode

The Home screen is the first screen you encounter in Poly Video Mode. From this screen, you have quick access to many of the system functions.

 **NOTE:** Some elements of your screen may be different depending on the system configuration.



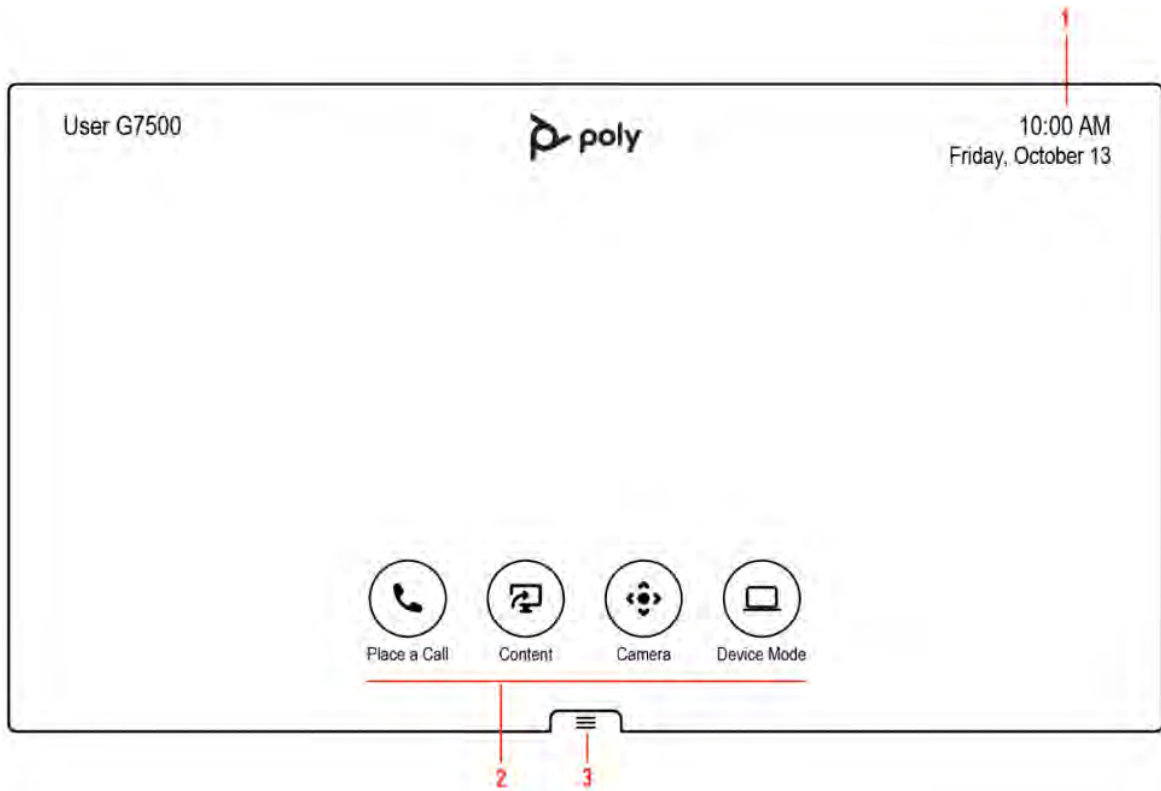

Home Screen



Ref. Number	Description
1	System information bar, which shows details such as date/time and system name.
2	Task buttons for placing calls, managing content, controlling cameras, or launching Poly Device Mode.
3	Menu for accessing other features.

Some of the following interactive and read-only elements might not display on your system depending on the system configuration.

Element	Description
Name	Descriptive name determined by the system administrator. Used when you want to connect to a system.
IP address	IP address, SIP, H.323, or secondary network configured for your system.

Element	Description
Current time	Local time zone.
Current date	Local time zone date.
Calendar or Favorites cards	View your calendar or favorites.
Place a Call 	Opens a call screen where you can dial a call, or you can select a card to dial numbers, access favorites, or view your calendar.
Content 	When content is available, the system displays a list of available content. Otherwise, this function opens a help screen that describes how to set up content sharing using HDMI, the Polycom Content App, or an AirPlay- or a Miracast-certified device.
Camera 	Opens the camera control screen.
Poly Device Mode 	Launches Poly Device Mode, which allows you to use the Poly Video system as an external camera, microphone, and speaker for your connected laptop.
Menu 	Opens new menu selections for calling, sharing content, camera control, and additional functions.

Access the Poly Control Center

If your system is using a conferencing application that isn't Poly, you can still access the TC10 device and paired video system settings in the Poly Control Center.

- On the right side of the device touchscreen, swipe left or touch the Poly touch button on the bottom right of your touch screen.

The Poly Control Center opens.

Waking the Poly TC10

After a period of no activity, the system enters sleep mode (if configured by your administrator). When the motion sensor over the touchscreen detects movement, it wakes up the display.

Accessibility Features

Poly products include a number of features to accommodate users with disabilities.

Users Who Are Deaf or Hard of Hearing

Your system includes accessibility features so that users who are deaf or hard of hearing can use the system.

The following table lists the accessibility features for users who are deaf or hard of hearing.

Table 2-2 Accessibility Features for Users Who Are Deaf or Hard of Hearing

Accessibility Feature	Description
Visual notifications	Status and icon indicators let you know when you have incoming, outgoing, active, or held calls. Indicators also alert you of the device's status and when features are enabled.
Status indicator lights	The system uses LEDs to indicate some statuses, including if your microphones are muted.

Table 2-2 Accessibility Features for Users Who Are Deaf or Hard of Hearing (continued)

Accessibility Feature	Description
Adjustable call volume	While in a call, you can raise or lower the volume of the device.
Auto-answering	You can enable the system to auto-answer calls.

Users Who Are Blind, Have Low Vision, or Have Limited Vision

Your system includes accessibility features so that users who are blind, have low vision, or have limited vision can use the system.

The following table lists the accessibility features for users who are blind, have low vision, or have limited vision.

Table 2-3 Accessibility Features for Users Who Are Blind, Have Low Vision, or Have Limited Vision

Accessibility Feature	Description
Auto-answering	You can enable the system to auto-answer calls.
Adjustable backlight settings	You can change the brightness of the screen by adjusting backlight intensity settings.
Visual notifications	Status and icon indicators let you know when you have incoming, outgoing, active, or held calls. Indicators also alert you of the device's status and when features are enabled.

Users with Limited Mobility

Your system includes accessibility features so that users with limited mobility can use various system features.

The following table lists the accessibility features for users with limited mobility.

Table 2-4 Accessibility Features for Users with Limited Mobility

Accessibility Feature	Description
Alternative control interface	This product provides an alternative control interface for the connected video conferencing system for people with disabilities that cause limited manipulation issues.
Auto-answering	You can enable the system to auto-answer calls.
Calling from a personal device	With administrator credentials, you can wirelessly access the system web interface from your own device to make calls and manage contacts and favorites.
Flexible mounting/display configurations	Product isn't stationary and can be mounted or displayed in various configurations. Touch controls require minimal strength to operate.

3 Using the Poly TC10 in Poly Video Mode

Pair the Poly TC10 with a video system and set the **Provider** to **Poly** in the system web interface to control and manage your Poly video system with the Poly TC10.



NOTE: Poly Video Mode isn't available if the Poly TC10 is in standalone mode.

Calling

There are several ways to initiate calls on the system. You can place a call by entering your contact's name or number, choosing a contact in the directory, calling a favorite or recent contact, or joining a scheduled meeting.

You can place calls using the following methods:

- Call using the dialpad
- Call a contact
- Call a frequently used number
- Call a recent contact
- Call a favorite
- Join a meeting from the calendar

Placing Calls





You can place audio calls, video calls, and call into meetings using the onscreen keyboard.

Use the following dialing formats when placing calls:

- IPv4 address: 192.0.2.0
- Host name: room.company.com
- SIP address: user@domain.com
- H.323 or SIP extension: 2555
- Phone number: 9782992285

Place a Call

You can place an audio or video call to a contact.

1. Go to **Place a Call**.
2. On the **Dialpad**  screen, move the slider to **Audio**  or **Video** .
3. Enter a number on the dialpad or select **Keyboard**  to enter characters.
4. Select **Call**.

Answer a Call

The way the system handles incoming calls depends on how your administrator configured it. The system either answers the call automatically or prompts you to answer manually.

- If you receive an incoming call notification, select **Answer**.

Ignore a Call

If the system doesn't answer incoming calls automatically, you can choose to ignore the call rather than answer it.

- If you receive an incoming call notification, select **Ignore**.

End a Call

When your call is complete, hang up the call. If you have content such as blackboards, whiteboards, or snapshots, the system asks if you want to keep them.

- Select **Menu**  > **Hang Up**.

Calling Contacts

You can access and call contacts, recent contacts, and frequent contacts on your system.

If configured by your administrator, contacts display on the *Place a Call* screen. Contact cards can display the following information:

- Contact name
- Contact number
- Contact email address
- Contact IP address

Call a Contact

To quickly dial a contact, you can search and select a contact card from the results. Contact cards display for frequent contacts, directory contacts, and favorites.

1. Using the controller or remote control, select **Place a Call** > **Contact**.
2. In the search field, use the onscreen keyboard to type characters or numbers and select **Search**.
3. Select a contact card to view contact details.
4. Select **Call**.

Call a Recent Contact

You can quickly call recent contacts from a list (organized by most to least recent).

1. Go to **Place a Call > Recent**.
2. Scroll through the list of recent contacts (sorted by date) and select one.

The call automatically dials.

Calling Favorite Contacts

To quickly access a short list of contacts you call most often, create favorites.

Favorites display on the *Favorites*, *Contacts*, or *Home* screens, depending on your system configuration. The system adds a star icon next to the contact's name, providing you an easy way to identify and call favorites.

Favorite a Contact

Create favorites to display contacts that you call the most often.

1. Go to **Place a Call > Contacts**.
2. Select a contact card, then select **Favorite**.

The contact receives a star icon and displays in the **Contacts** and **Favorites** lists.

Unfavorite a Contact

Unfavorite a contact to remove the contact from your **Favorites** list.

1. Go to **Place a Call > Favorites**.
2. Choose a favorite card, then select **Unfavorite**.

The contact is removed from the **Favorites** list.

Call a Favorite Contact

To quickly call a contact, select a favorite card.

1. Select a favorite card on the *Favorites*, *Contacts*, or *Home* screen.
2. Select **Call**.

Joining Meetings from the Calendar

On the *Home* screen, you can join meetings directly from your calendar using the meeting cards on the screen (if configured).



NOTE: If calendaring isn't configured for your system, the system doesn't display meeting cards. You must dial manually to join meetings.

Meeting Cards

If configured, meeting cards display on the *Home* screen. You can access meeting cards to view meeting details.

Meeting cards display the following scheduling information:

- All-day meetings display as the first meeting card.
- For meetings scheduled later in the day, a **Free until [time/day]** message displays, followed by upcoming meeting cards in the time and date order they're scheduled.
- For meetings scheduled later in the week, a **Free until [time/day]** message displays until the day of the next scheduled meeting.
- If there are no scheduled meetings for the current week, a **No Meetings** message displays.

View Meeting Cards

On the *Home* screen, you can view meeting cards that show your calendar event details. Meeting cards display meeting times, subjects, and organizers.



NOTE: Private meetings are labeled **Private Meeting**. Except for the time, meeting details are hidden.

- Do one of the following:
 - To view meeting information, choose a meeting card.
 - To view upcoming scheduled meetings, select a card and scroll to the right.

Join a Meeting from a Meeting Card

On the *Home* screen, you can select a meeting card for options to join a meeting.

The system supports automatic dialing if the meeting organizer added calling information to the calendar event and your administrator has configured calendaring.

- Do one of the following:
 - On a current meeting card, select **Join**.
 - If the meeting card doesn't include calling information, select to display the dialpad. Dial the number to join the meeting.

Join an Overbooked Meeting

If two or more meetings are scheduled at the same time, the meetings display as **Overbooked**. You can join one of the meetings using its individual meeting card.

1. Select an overbooked meeting card.
The individual meeting cards display.
2. Choose one of the meeting cards and select **Join** to connect to the meeting.

Join a Password-Protected Meeting

Some meetings may require a password to join.

Make sure that you have the password for password-protected meetings before you join. If you don't have a meeting password and a message prompts you for one, contact the meeting organizer for the password.



NOTE: Meeting cards don't indicate if a meeting is password protected.

1. Do one of the following:
 - Manually dial in to a meeting.
 - Join a meeting from a meeting card.
2. Enter the meeting password and select **Join**.

If you enter an incorrect password, the password prompt displays again.

Sharing Content

You can manage aspects of live content sharing from your device.

Minimize Content

You can minimize shared content to the content tray.

1. On the *Home* screen, select **Content**.
2. Select **Minimize** — next to the content you want to minimize.

The content is available in the content tray if you need it.

Maximize Content

You can expand content that's in the content tray.

1. On the *Home* screen, select **Content**.
2. From the content tray, select the content you want to display on the screen.

Take a Snapshot of Your Content

You can take a picture of your current content.

A limited number of snapshots are available. A prompt notifies you when you have reached the snapshot limit.

- With a board or content on the screen, select **Snapshot** .

The system captures the content and displays it as *Snapshot-1*. The system names additional snapshots with successive numbers.

Delete Snapshots or Content

You can delete snapshots or content that you no longer need.

1. Select a snapshot or piece of content in the content tray.
2. Select **Delete**  and confirm that you want to delete it.

 **NOTE:** This option isn't available for content shared from a far-site participant. To delete that content, you must end the call.

End a Call with Blackboard or Whiteboard Content

If there's an open blackboard or whiteboard in your call (including drawings, markup, snapshots, or even a blank board), you can keep that content session going after hanging up. (Markup doesn't include highlights.)

1. In a call with blackboard or whiteboard content, select **Hang Up** .

The call ends and the system prompts if you want to keep content.

2. Do one of the following:
 - Select **Yes, Keep Content**.
 - Select **No, End Session**.

If you keep content, the content session continues.

Cameras

Camera controls are available in and out of calls.

You can control cameras, depending upon the camera type, in the following ways:



- Adjust an in-room camera
- Turn camera tracking on or off

Adjust an In-Room Camera

To enhance the view of meeting participants, make adjustments to the in-room camera.

If camera tracking is on, camera control is unavailable. Turn tracking off to access camera controls.

With the Studio X50 and Studio X30 systems, you can't pan or tilt the camera if it's zoomed all the way out.

1. Select **Camera** .
2. On the *Camera Control* screen, select **Main** from the drop-down menu.
3. Press **+** to zoom in or **-** to zoom out. Press the arrows to tilt up and down or to pan left to right.
4. To exit the control screen, select **Back** .

Adjust a Far-Site Camera

To enhance your view of the other meeting participants during a call, you can adjust the far-site camera.

If camera tracking is on, camera control is unavailable. Turn tracking off to access camera controls.





NOTE: Contact your administrator for help setting up this feature.

1. Select **Camera** .
2. On the *Camera Control* screen, select **Main (Far)** from the drop-down menu.

3. Press **+** to zoom in or **-** to zoom out. Press the arrows to tilt up and down or to pan left to right.
4. To exit the control screen, select **Back** ← .

Turn Your Camera On or Off

You can turn your camera on to show local video or turn your camera off to hide your local video.

1. If you're out of a call, select **Menu** ≡ .
2. Select **On**  or **Off**  to show or hide your video.

Turn Camera Tracking On or Off

When camera tracking is on, the camera automatically frames the group of people in the room or the current speaker (depending on your camera and how your system is configured).

 **NOTE:** If you mute your local microphone, the system disables speaker tracking.

1. Select **Camera**  .
2. Toggle **Camera Tracking** on () or off ().

Selecting the Primary Camera

In Poly Video Mode, if you have more than one camera attached to the system, you can select the primary camera in or out of a call.

Camera Priority

When you connect or disconnect a camera, camera priority determines the primary or active camera.

The system observes the following camera type priority:

1. Embedded camera
2. HDCI camera
3. USB camera
4. HDMI source set to display as people

Select the Primary Camera Using the Poly TC10

When you attach multiple cameras to the system, you can select the primary camera from the TC10 *Camera Controls* screen.

1. Select **Camera**  .
2. From the camera drop-down menu, select a camera.
The selected camera becomes the primary camera.

Using Camera Presets

If your camera supports presets, you can save up to 10 camera positions. Camera presets are stored camera positions that let you quickly point a camera at predefined locations in a room.

Near camera presets are available in or out of a call. Far camera presets are only available during a call. If enabled, you can use them to control the far-site camera.

When you save a preset, the preset saves the selected camera and the camera position.



NOTE: If camera tracking is on, camera controls and presets are unavailable. Turn tracking off to access these features.

Save a Camera Preset Using the Poly TC10

Save the current camera position as a preset for later use.

Use saved presets to change the near camera position in or out of a call. Far camera presets are available only in a call.

1. Select **Camera**  .
2. Adjust the camera to the desired position.
3. Under **Presets**, do one of the following:
 - On an empty preset card, press the preset card.
 - To replace a preset, long press the preset card for 1 second.



Select a Preset

Using previously created camera presets, you can quickly move the camera to a desired position in a call.

1. Select **Camera**  .
2. Select the image of the preset you want.

Delete a Preset

You can delete a camera preset that you no longer need.

1. Select **Camera**  .
2. Select **Delete**  .

Environment Controls

Using the Poly TC10, you can control room elements that enable you to customize your meeting environment.

Control Room Elements Using the Poly TC10

You can control room elements such as electronic shades, smart lighting, monitors, and projectors using the Extron Room Control App on the Poly TC10.

The administrator must enable the **Environment** menu option and configure the room elements using an Extron processor.

1. Select **Environment**  .
2. Choose one of the following:
 - **Lights** - Adjust the lights in the room.
 - **Shades** - Adjust the electronic shades in the room.
 - **Display** - Control monitors and projectors in the room.

Settings

Before or during calls, you can adjust video and audio settings, including adjusting the volume and changing the video layout.

Video Adjustments

You can manage video and certain user interface settings.

Change the Participant Layout

During a call, you can change from the current layout to another layout better suited for the meeting. The layout frames include the near site and far site.

If you're sharing content on a single monitor, content displays in one of the frames.



1. In a call, go to **Layouts**.
2. Select one of the following layouts:
 - **Equal**: All participants are the same size.
 - **Gallery**: Participants display at the top of the screen and the speaker displays in the main frame.
 - **Fullscreen**: The active speaker displays in full screen.

Audio Adjustments

You can control several audio settings on the system.

Mute Your Microphones

To prevent distractions for the speaker and meeting participants, you can mute your microphones. You can mute your audio in or out of a call.



- Do one of the following:
 - Out of a call, select **Menu**  > **Mute**  .

- In a call, select **Mute**  .

A notification displays that the system muted your local microphones.

Unmute Your Microphones

When your audio is muted and you're ready to speak in a call, unmute your microphones.

- Do one of the following:
 - In a call, select **Unmute**  .
 - Out of a call, select **Menu**  > **Unmute**  .

Adjust the Volume

You can adjust the volume before or during a call.

1. Do one of the following:
 - In a call, select **Volume**.
 - Out of a call, select **Menu**  > **Volume**.
2. Use the volume slider to increase or decrease the speaker volume.

Poly TC10 LED Status Indicators as a Room Controller in Poly Video Mode

The following table lists each LED indicator and its related status while the Poly TC10 is operating in Poly Video Mode as a room controller.

Table 3-1 Poly TC10 Status Indicators as a Room Controller in Poly Video Mode

Status	LED Color	Animation Behavior
Boot initialization in progress	White	Breathing
Idle (not in a call)	White	Solid
Sleep	Amber	Solid
Incoming call	Green	Fluttering
Outgoing call	Green	Solid
Call in progress	Green	Solid
Muted microphone/Audio mute	Red	Solid
Firmware update in progress	Amber	Breathing

4 Using the Poly TC10 Touch Controller in Partner Modes

You can launch any Poly Partner app including Microsoft Teams and Zoom Rooms in paired mode. You can also launch Zoom Rooms in standalone mode.

When you launch Zoom Rooms, you can choose to run Zoom Rooms Controller or Zoom Rooms Scheduler.

Switch Between Zoom Controller and Zoom Scheduler Mode

You can switch between Zoom Rooms Controller and Zoom Rooms Scheduler in the Poly TC10 user interface settings.

1. On the Poly TC10, choose **Settings**.
2. Select **General**.
3. Scroll down and select **Switch to Controller** or **Switch to Scheduler**.

 **NOTE:** The option available depends on what mode that you're currently running.

Using the Poly TC10 in Zoom Rooms Controller Mode

The Poly TC10 in Controller mode controls the functionality of the Zoom Room (either Studio X-series or a PC), including any video/audio capabilities.

Start an Instant Meeting in Zoom Rooms

You can start an instant meeting from the Zoom Rooms home screen.

- On the Home screen, select **New Meeting**.

Start a Scheduled Meeting in Zoom Rooms

You can start a scheduled meeting in Zoom Rooms using the meeting's calendar card or meeting ID.

- To start a scheduled meeting in Zoom Rooms, do one of the following:
 - Select **Join**, enter the **Meeting ID**, and select **Join**.
 - On the Home screen, select the calendar card, and select **Start**.

Call a Contact in Zoom Rooms

You can call people or Zoom Rooms listed in your contacts list.

1. Select **Contacts**.
2. Select the contact you want to call.
3. Select **Meet**.
4. To end the call, select **End**.

Sharing Content in Zoom Rooms from a Poly TC10

You can share content from a connected desktop, iPhone, iPad, or camera in Zoom Rooms.

1. In the active meeting window, select **Share Content**.
2. Select the sharing method that you want to use:
 - Desktop - Uses a connected desktop to share content using the Zoom Rooms app or a web browser.
 - iPhone/iPad - Uses iOS screen mirroring to share content from an iPhone or iPad.
 - Camera - Shares content from a connected camera.
3. Follow the onscreen instructions to share your content.
4. Select **Stop Sharing** to end sharing.

Sharing Content in Zoom Rooms Using a Sharing Key or Meeting ID

You can share content to a Zoom Room by using a sharing key or a meeting ID.

1. In the active meeting window, select **Share Content**.
The **Share Content** dialog box, the sharing key and meeting ID display.
2. On the computer or device from which you want to share, do one of the following:
 - Open the Zoom app, click Share Content, enter the sharing key, and select **Share Screen**.
 - Go to www.zoom.us/share and enter the meeting ID. Select the screen or application that you want to share.
3. Select **Stop Sharing** to end sharing.

Poly TC10 LED Status Indicators in Zoom Rooms Controller Mode

The following table lists each LED indicator and its associated status while the Poly TC10 is operating in Zoom Rooms as a meeting controller.

Table 4-1 TC10 LED Status Indicators as a Meeting Controller in Zoom Rooms

Status	LED Color	Animation Behavior
Boot up in progress	White	Breathing

Table 4-1 TC10 LED Status Indicators as a Meeting Controller in Zoom Rooms (continued)

Status	LED Color	Animation Behavior
Idle (not in a call)	White	Solid
Outgoing call	Green	Solid
Call in progress	Green	Solid
Muted microphone / Audio mute	Red	Solid
Firmware update in progress	Amber	Breathing

Using the Poly TC10 in Zoom Rooms Scheduler Mode

Run Zoom Rooms Scheduler on a Poly TC10 mounted outside a meeting room to manage the room. The Poly TC10 displays the current status of the room and any scheduled meetings.

 **IMPORTANT:** To be able to reserve a Zoom Room directly on the Zoom Room Scheduler, an administrator must sync a calendar to the Zoom Room in the **Room Management** area in the Zoom Room web portal.

Schedule a Meeting on the Zoom Rooms Scheduler

You can schedule a meeting directly on the Zoom Room Scheduler to reserve a time slot for the Zoom Room.

1. On the Zoom Room Scheduler, select **Reserve**.
2. If you have a floor plan for your location configured in the Zoom web portal, you can reserve a different meeting space by selecting **Reserve Another Room**.
3. Enter a name for the meeting in the **New Meeting** field.
4. If required, toggle the options for **Require Meeting Passcode** and **Waiting Room**.
5. Add the email addresses of the participants, selecting the enter key on the keyboard to add each one to the list.
6. Drag and drop the two blue lines to set the start and end times of the meeting.
7. Select **Reserve**.

The new meeting adds to the calendar and participants receive an invite via email.

Delete a Meeting from the Zoom Rooms Scheduler

You can delete a scheduled meeting directly from the Zoom Rooms Scheduler.

You can only delete a meeting that was reserved on the Zoom Rooms Scheduler. For meetings scheduled using the synced calendar, only a **Close** option appears when you select it.

1. On the Zoom Room Scheduler, select the meeting you want to delete.
2. Select **Delete**.

The meeting no longer appears on the list of upcoming meetings on the Scheduler.

Disable Instant Room Reservation

Administrators can disable instant room reservation on the Zoom web portal.

1. Log into <https://zoom.us/profile> with an administrator login.
2. Select **Room Management > Zoom Room**.
3. Search for the Zoom Room you want to manage.
4. Select **Edit**.
5. Select **Scheduling Display**.
6. Disable **Instant Room Reservation** by switching the toggle to the left.

Poly TC10 LED Status Indicators in Zoom Rooms Scheduler Mode

The following table lists each LED indicator and its associated status while the device is in Zoom Rooms Scheduler Mode.

Table 4-2 TC10 LED Status Indicators in Zoom Rooms Scheduler Mode

Status	LED Color	Animation Behavior
Boot up in progress	White	Breathing
Room available	Green	Solid
Room occupied - meeting in progress	Red	Solid
Firmware update in progress	Amber	Breathing

Using the Poly TC10 as a Microsoft Teams Controller

Run the Microsoft Teams controller app on a Poly TC10 device to easily manage Microsoft Teams meetings.

When paired with a Microsoft Teams account, you can use Poly TC10 as a companion controller for Microsoft Teams Rooms. Use the Poly TC10 to start or join a meeting, share content, and manage all aspects of a Teams meeting.

Start or Join a Meeting in Microsoft Teams Rooms

You can start or join a meeting in Microsoft Teams Rooms directly from your Poly Controller.

You can join a scheduled or unscheduled meeting or start a new meeting.

- To join a scheduled meeting, on the meeting tile, select **Join**.
- To join a meeting that isn't on your calendar, select **Join with meeting ID**, and enter the meeting ID.
- To start a new meeting, select **Meet**.

Call a Contact in Microsoft Teams Rooms

You can call contacts from your contacts list.

To call a contact from your contacts list:

1. Select **Meet**.
2. Search for a contact under **Type Your Name**.
3. Select the contact you want to meet.

The contact will be called in an instant meeting.

Manage a Meeting in Microsoft Teams Rooms

You can manage various aspects of a Microsoft Teams Rooms meeting directly from your Poly Controller.

Manage your Microsoft Teams meeting using the icons available to you in the meeting controls.

- To add a participant, search for their name in the search bar, then select the participant.
- To toggle between different views, select **View**.
- To share content from a connected device or the Teams whiteboard, select **Share Content**.

Poly TC10 LED Status Indicators in Microsoft Teams Rooms Controller Mode

The following table lists each LED indicator and its associated status while the device is in Microsoft Teams Rooms Controller Mode.

Table 4-3 Poly TC10 LED Status Indicators in Microsoft Teams Rooms Controller Mode

Status	LED Color	Animation Behavior
Boot up in progress	White	Breathing
Boot complete	White	Solid
Call incoming	Green	Pulsing
Call in progress	Green	Solid
Mic muted	Red	Solid
Firmware update in progress	Amber	Breathing

5 Device Maintenance

You have several options to keep your device running properly.

Unpair the TC10 from a Video System

Unpair the TC10 if you no longer want to use it with a particular video system.

Don't unpair devices if you plan to use them with the same system. For example, if you move your video-conferencing equipment to another room, just disconnect and reconnect the devices in the new location.

1. In the system web interface, go to **General Settings > Device Management**.
2. Under **Connected Devices**, find the device by its MAC address (for example, **00e0db4cf0be**) and select **Unpair**.

The unpaired device moves from **Connected Devices** to **Available Devices** (which shows discovered devices you can pair with the system).

Restart the Poly TC10

If you have issues, you can try restarting the Poly TC10.

1. For a wall- or glass-mounted device, dismount it and remove any wall mounting brackets. For a desk-mounted device, remove the TC10 stand. For more information, see the relevant Quick Start Guide.
2. Disconnect the LAN cable from the Poly TC10 and reconnect it.

6 Troubleshooting

These troubleshooting tips can help when encountering issues with your TC10 device.

View the Poly TC10 and Paired Video System Information

You can see basic information about your TC10 and the paired video system in the device local interface.

Some of the Poly TC10 and video system details include:

- Device name
 - Name of paired-video system
 - Model
 - MAC address
 - IP address
 - Hardware version
 - Software version
 - Serial number
- In the device local interface, go to **Settings**  > **Information**.

Zoom Rooms Pairing Error

Symptom:

You get an error message when pairing a Poly TC10 to a Zoom Room that is already logged into a room.

Workaround:

Ignore the code and pair the device to the Zoom Room using the authorization code or enter the pairing code at zoom.us/pair

7 Getting help

Poly is now a part of HP. The joining of Poly and HP will pave the way for us to create the hybrid work experiences of the future.

During the merge of our two organizations, information about Poly products will transition from the [Poly Support](#) site to the [HP® Support](#) site.

The [Poly Documentation Library](#) will continue to host the installation, configuration, and administration guides for Poly products in HTML and PDF format. In addition, the Poly Documentation Library will provide Poly customers with up-to-date status information about the transition of Poly content from the [Poly Support](#) site to the [HP® Support](#) site.

■ HP Inc. addresses

HP US
HP Inc.
1501 Page Mill Road
Palo Alto 94304, U.S.A.
650-857-1501

HP Germany
HP Deutschland GmbH
HP HQ-TRE
71025 Boeblingen, Germany

HP UK
HP Inc UK Ltd
Regulatory Enquiries, Earley West
300 Thames Valley Park Drive
Reading, RG6 1PT
United Kingdom

■ Document information

Model ID: Poly TC10 (model: P030)

Document part number: 3725-13686-002A

Last update: August 2023

Email us at documentation.feedback@hp.com with queries or suggestions related to this document.