

# Yealink | 亿联网络



## W80 Multi-Cell System User Guide

# Contents

<b>Getting Started.....</b>	<b>7</b>
Hardware Overview.....	7
W80DM/W80B Hardware.....	7
W56H Hardware.....	8
W53H Hardware.....	10
W73H Hardware.....	12
W78H Hardware.....	13
W57R Hardware.....	15
W59R Hardware.....	16
CP930W Hardware.....	18
CP935W Hardware.....	20
DD Phone Hardware.....	21
W56H/W53H Power LED Indicator.....	24
CP930W Mute Touch Key LED Indicators.....	24
Menu on the W56H/W53H.....	25
Main Menu.....	25
Submenu.....	26
Returning to Idle Screen.....	27
Screen and Icons.....	27
Idle Screen.....	27
CP930W/DD Phone Calls Screen.....	29
Icons on the Idle Screen.....	29
W56H/W53H Line Status Screen.....	30
W56H/W53H Icons on the Calls Screen.....	30
W56H/W53H Icons on the Line Status Screen.....	31
Rechargeable Battery.....	31
Viewing the Power Status.....	31
Entering Characters.....	31
Setting the Input Modes.....	31
Entering Data on the W56H/W53H.....	32
Entering Data on the CP930W/DD Phone.....	32
<b>Registering the Handset.....</b>	<b>33</b>
Possible Reasons for Registration Failure.....	33
Registering Handsets at the DECT Manager.....	33
Selecting a System to Connect.....	34
<b>Call Features.....</b>	<b>34</b>
Placing Calls.....	34
Placing External Calls.....	35
Placing a Call from the Call History.....	35
Placing a Call from the Directory.....	35
Speed Dial on the W56H/W53H.....	36
Speed Dial on the DD Phone.....	37
Redial.....	37
Placing an Anonymous Call.....	38
Answering Calls.....	39

Answering a Call.....	39
Answering a Call When in a Call.....	39
Answering a Call Automatically.....	40
Disabling Call Waiting.....	40
Silencing or Rejecting Incoming Calls.....	40
Silencing a Call.....	40
Rejecting a Call Manually.....	40
Rejecting Anonymous Calls.....	41
Rejecting Calls with Do Not Disturb (DND).....	41
Ending Calls.....	41
Muting/Unmuting Audio.....	41
Holding and Resuming Calls.....	42
Holding a Call.....	42
Resuming a Held Call.....	42
Call Forward.....	42
Forwarding Incoming Calls.....	42
Transferring Calls.....	43
Performing a Blind Transfer.....	43
Performing a Semi-Attended/Attended Transfer.....	43
Conference Calls.....	43
Local Conference.....	44
Hybrid UC Meeting.....	45
Network Conference.....	46
Recording Using an SD Card.....	47
Recording a Call.....	48
Pausing/Resuming a Recording.....	48
Stopping a Recording.....	48
Managing the Recordings.....	48
Viewing the Available Recording Time.....	49
<b>Advanced Call Features.....</b>	<b>50</b>
Call Park and Call Retrieve.....	50
Parking or Retrieving a Call in the FAC Mode.....	50
Parking or Retrieving a Call in the Transfer Mode.....	51
Retrieving a Call with a Retrieve Key.....	51
Shared Call Appearance (SCA).....	52
W56H/W53H State Indicator of Shared Line.....	52
Placing Calls on a Shared Line.....	53
Answering Calls on a Shared Line.....	53
Placing a Call on Public Hold.....	53
Placing a Call on Private Hold.....	53
Retrieving a Held Call on a Shared Line.....	53
Barging in an Active Call on a Shared Line.....	54
Pulling a Shared Call on a Shared Line.....	54
Voice Mail.....	54
Setting the Voice Mail Code.....	54
Leaving Voice Mails.....	55
Listening to Voice Mails.....	55
<b>Directory.....</b>	<b>55</b>
Local Directory.....	55
Adding Contacts.....	55
Viewing Contacts.....	56
Editing Contacts.....	56

Deleting Contacts.....	56
Searching for Contacts.....	57
Shared Directory.....	57
Adding Shared Contacts.....	57
Editing Shared Contacts.....	57
Deleting a Shared Contact.....	58
Deleting All Shared Contacts.....	58
Searching for Shared Directory Contacts.....	58
Saving a Shared Contact to the Local Directory.....	58
Blocklist.....	59
Adding a Blocklist Contact.....	59
Viewing Blocklist Contacts.....	59
Editing a Blocklist Contact.....	59
Deleting Blocklist Contacts.....	60
Remote Phone Book.....	60
Searching for Remote Phone Book Contacts.....	61
Viewing Remote Phone Book Contacts.....	61
Saving a Remote Phone Book Contact to the Local Directory.....	61
<b>Call History.....</b>	<b>61</b>
Call History Icons.....	62
Viewing History Records.....	62
Saving a History Record to Local Directory.....	62
Saving a History Record to Blocklist.....	63
Deleting History Records.....	63
Deleting a Call Record.....	63
Deleting All Call Records.....	63
<b>Customizing Your Phone.....</b>	<b>64</b>
Turning Handset On.....	64
Turning Handset Off.....	64
Changing the Wallpaper.....	65
Setting the Screen Saver.....	65
Changing the W56H/W53H/CP930W Brightness.....	65
Changing the DD Phone Brightness.....	66
Setting the Keypad Light.....	66
Changing the Language.....	66
Time & Date.....	67
Setting the Time and Date Manually.....	67
Changing the Time and Date Format.....	67
Customizing the Soft Keys.....	67
Shortcuts.....	68
Supported Shortcuts.....	68
Customizing the Shortcuts.....	69
Locking Your W56H/W53H.....	69
Locking Handset Keypad.....	70
Unlocking Your Handset.....	70
Locking Your DD Phone.....	70
Setting the Phone Lock.....	70
Locking Your Phone Manually.....	71
Unlocking Your Phone.....	71
Changing Your Phone Unlock PIN.....	71
Silent Mode.....	71
Switching on Silent Mode.....	72

Switching off Silent Mode.....	72
<b>Audio Settings.....</b>	<b>72</b>
Adjusting the Volume.....	72
Setting the Ring Tone.....	72
Setting the Ring Tone for the External Calls.....	73
Silent Charging.....	73
Setting the Advisory Tone.....	73
Setting the Vibrator.....	74
Setting the Key Tone.....	74
Disabling the Noise Cancellation.....	74
<b>W59R/W78H Bluetooth.....</b>	<b>75</b>
Enabling/Disabling the Bluetooth.....	75
Searching and Pairing with a Bluetooth Headset.....	75
Managing Paired Headsets.....	75
Editing Device Name of Your Handset.....	76
<b>Connecting a Mobile Phone via Bluetooth.....</b>	<b>76</b>
Activating the Bluetooth Mode.....	76
Pairing and Connecting the Bluetooth-enabled Mobile Phone.....	77
Enabling the Phone Audio.....	77
Enabling the Phone Media.....	77
Handling a Mobile Phone Call on the Phone.....	78
Editing Device Name of Your Phone.....	78
Making the Phone Discoverable.....	78
Deleting the Paired Bluetooth Device.....	79
Disconnecting the Bluetooth Device.....	79
Deactivating the Bluetooth Mode.....	79
<b>Using Your CP930W with PC.....</b>	<b>80</b>
Connecting the PC to the Phone.....	80
Setting the Phone as PC Audio Device.....	80
Setting the Phone as PC Audio Device via Softphone.....	81
Setting the Phone as PC Audio Device via PC.....	81
Placing Calls via PC.....	81
Holding/Resuming the PC Audio.....	81
Muting/Unmuting the Microphone.....	82
<b>WH62/WH63 Headsets.....</b>	<b>82</b>
Switching Mode.....	82
Registering the Headset.....	83
Pairing the Headset with a Handset.....	83
Using the Headset to Manage Calls.....	84
<b>Maintaining Your Phone.....</b>	<b>85</b>
Investigating Warnings.....	85
Resetting the Handset.....	85
Rebooting the Handset.....	85

**Appendix..... 86**

- Appendix A- Menu Structure.....86
  - For W56H/W53H/W73H.....87
  - For W73H.....88
  - For W78H.....90
  - For W57R/W59R.....91
  - For CP930W..... 92
  - For CP935W..... 93
  - For DD Phone.....94
- Appendix B - Input Modes and Characters..... 94
- Appendix C - Bluetooth Headset Compatibility List..... 95

# Getting Started

---

Before you use your phone, take some time to get familiar with its features and user interface.



**Note:** This guide mainly takes W56H as an example. Due to different LCD specifications and parameters, the graphics displayed on other handsets may be different.

- [Hardware Overview](#)
- [Menu on the W56H/W53H](#)
- [Screen and Icons](#)
- [Rechargeable Battery](#)
- [Entering Characters](#)

## Hardware Overview

---

Understanding the phone hardware helps you easily use the phone's features.

- [W80DM/W80B Hardware](#)
- [W56H Hardware](#)
- [W53H Hardware](#)
- [W73H Hardware](#)
- [W78H Hardware](#)
- [W57R Hardware](#)
- [W59R Hardware](#)
- [CP930W Hardware](#)
- [CP935W Hardware](#)
- [DD Phone Hardware](#)
- [W56H/W53H Power LED Indicator](#)
- [CP930W Mute Touch Key LED Indicators](#)

### W80DM/W80B Hardware

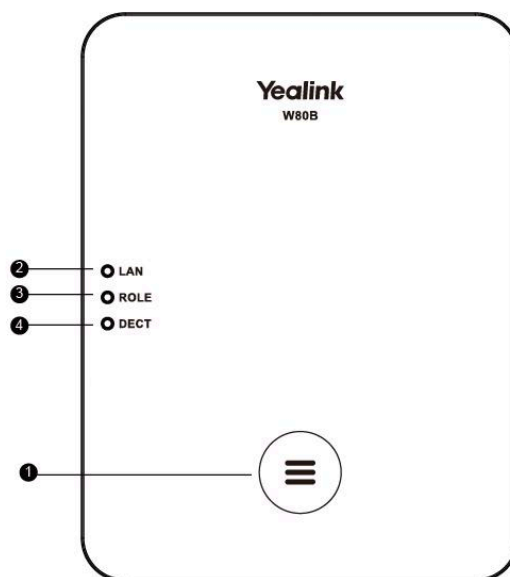

No.	Item	Description
1	Device Key	Long press for 20 seconds to reset the device to factory configurations.
2	LAN LED	<ul style="list-style-type: none"> <li>Indicates the power status.</li> <li>Indicates the LAN connection status.</li> </ul>
3	ROLE LED	Indicates the device role.
4	DECT LED	For W80B, indicates the connection status to the DECT manager (DM).

### W56H Hardware

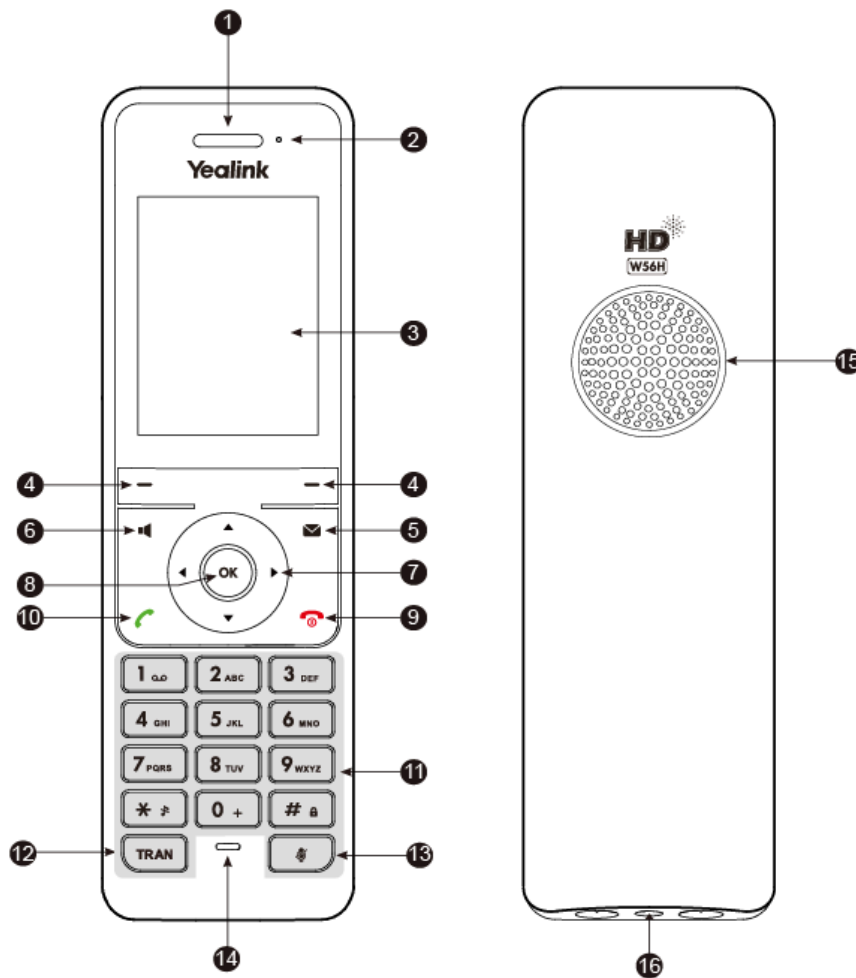

No.	Item	Description
1	Receiver	Receives audio in receiver mode.
2	Power LED Indicator	Indicates call status, message status, and charging status.
3	Phone Screen	Shows information.
4	Soft Keys	Access the function directly. It depends on the operating situation.

No.	Item	Description
5	Message Key	Accesses the voice mail or missed call.
6	Speakerphone Key	<ul style="list-style-type: none"> <li>• Switches among the receiver, headset, and handsfree modes.</li> <li>• Answers an incoming call.</li> <li>• Places a call in handsfree mode.</li> </ul>
7	Navigation Keys	Scroll through information or options on the screen.
8	OK Key	Confirms actions or enters the main menu.
9	On-hook Key/Power Key	<ul style="list-style-type: none"> <li>• Press briefly to return to the previous screen.</li> <li>• Long press to return to the idle screen.</li> <li>• Press to turn the handset on.</li> <li>• Long press on the idle screen to turn the handset off.</li> <li>• Cancels actions or ends a call.</li> <li>• Rejects an incoming call.</li> </ul>
10	Off-hook Key	<ul style="list-style-type: none"> <li>• Answers an incoming call.</li> <li>• Enters the redial calls list.</li> <li>• Places a call in receiver or headset mode.</li> </ul>
11	Keypad	Provides digits, letters, and special characters.
12	TRAN Key	Transfers a call to another party.
13	Mute Key	Toggles mute feature on or off.
14	Microphone	Picks up audio.
15	Speaker	Outputs audio in handsfree mode.
16	3.5mm Headset Jack	Connects a standard 3.5mm headset.

## W53H Hardware

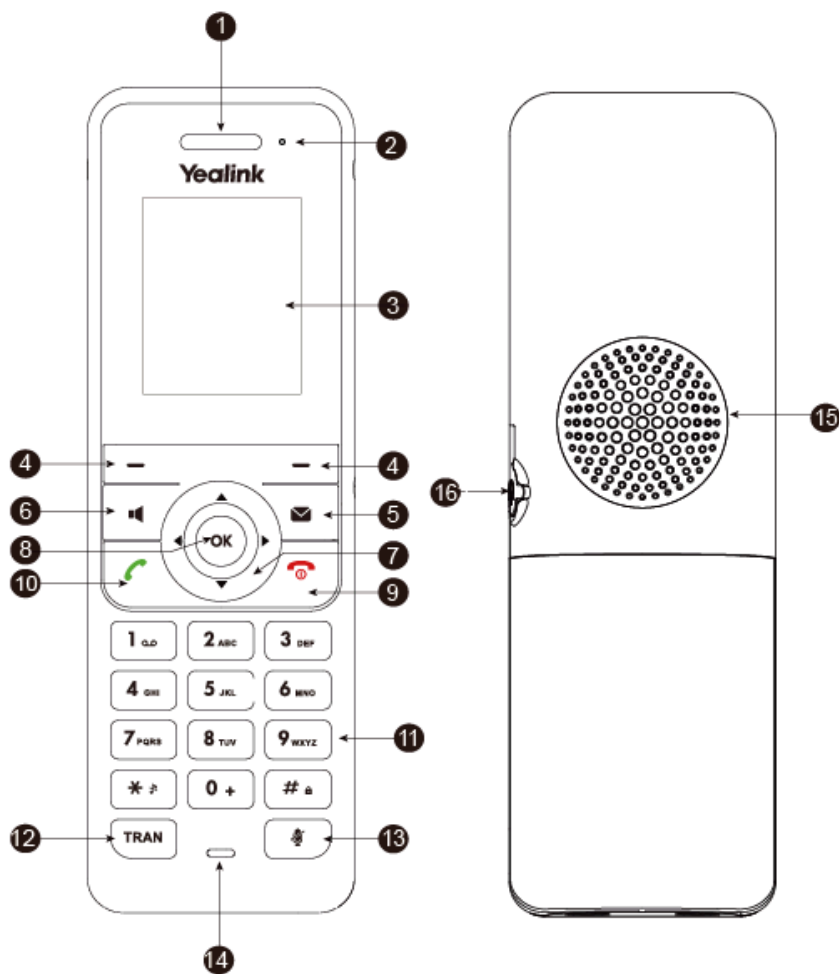

No.	Item	Description
1	Receiver	Receives audio in receiver mode.
2	Power LED Indicator	Indicates call status, message status, and charging status.
3	Phone Screen	Shows information.
4	Soft Keys	Access the function directly. It depends on the operating situation.
5	Message Key	Accesses the voice mail or missed call.
6	Speakerphone Key	<ul style="list-style-type: none"> <li>Switches among the receiver, headset, and handsfree modes.</li> <li>Answers an incoming call.</li> <li>Places a call in handsfree mode.</li> </ul>
7	Navigation Keys	Scroll through information or options on the screen.
8	OK Key	Confirms actions or enters the main menu.

No.	Item	Description
9	On-hook Key/Power Key	<ul style="list-style-type: none"> <li>• Press briefly to return to the previous screen.</li> <li>• Long press to return to the idle screen.</li> <li>• Press to turn the handset on.</li> <li>• Long press on the idle screen to turn the handset off.</li> <li>• Cancels actions or ends a call.</li> <li>• Rejects an incoming call.</li> </ul>
10	Off-hook Key	<ul style="list-style-type: none"> <li>• Answers an incoming call.</li> <li>• Enters the redial calls list.</li> <li>• Places a call in receiver or headset mode.</li> </ul>
11	Keypad	Provides digits, letters, and special characters.
12	TRAN Key	Transfers a call to another party.
13	Mute Key	Toggles mute feature on or off.
14	Microphone	Picks up audio.
15	Speaker	Outputs audio in handsfree mode.
16	3.5mm Headset Jack	Connects a standard 3.5mm headset.

## W73H Hardware

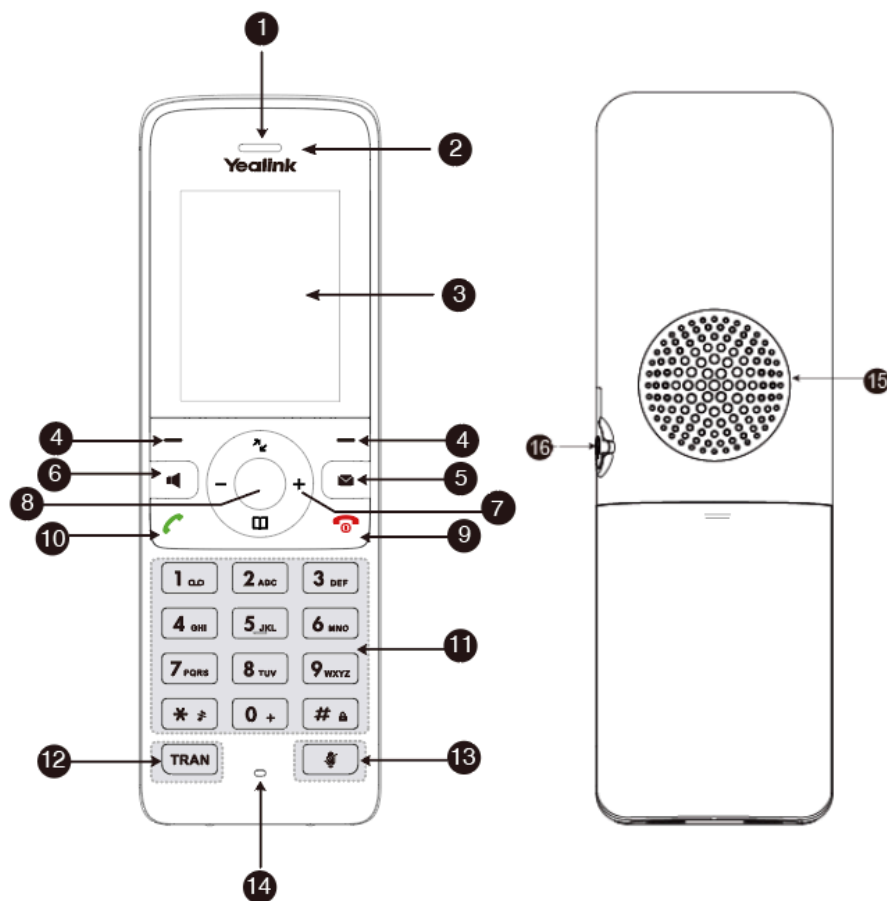

No.	Item	Description
1	Receiver	Receives audio in receiver mode.
2	Power LED Indicator	Indicates call status, message status, and charging status.
3	Phone Screen	Shows information.
4	Soft Keys	Access the function directly. It depends on the operating situation.
5	Message Key	Accesses the voice mail or missed call.
6	Speakerphone Key	<ul style="list-style-type: none"> <li>Switches among the receiver, headset, and handsfree modes.</li> <li>Answers an incoming call.</li> <li>Places a call in handsfree mode.</li> </ul>
7	Navigation Keys	Scroll through information or options on the screen.
8	OK Key	Confirms actions or enters the main menu.

No.	Item	Description
9	On-hook Key/Power Key	<ul style="list-style-type: none"> <li>Press briefly to return to the previous screen.</li> <li>Long press to return to the idle screen.</li> <li>Press to turn the handset on.</li> <li>Long press on the idle screen to turn the handset off.</li> <li>Cancels actions or ends a call.</li> <li>Rejects an incoming call.</li> </ul>
10	Off-hook Key	<ul style="list-style-type: none"> <li>Answers an incoming call.</li> <li>Enters the redial calls list.</li> <li>Places a call in receiver or headset mode.</li> </ul>
11	Keypad	Provides digits, letters, and special characters.
12	TRAN Key	Transfers a call to another party.
13	Mute Key	Toggles mute feature on or off.
14	Microphone	Picks up audio.
15	Speaker	Plays audio in handsfree mode.
16	3.5 mm Headset Jack	Connects a standard 3.5 mm headset.

### W78H Hardware

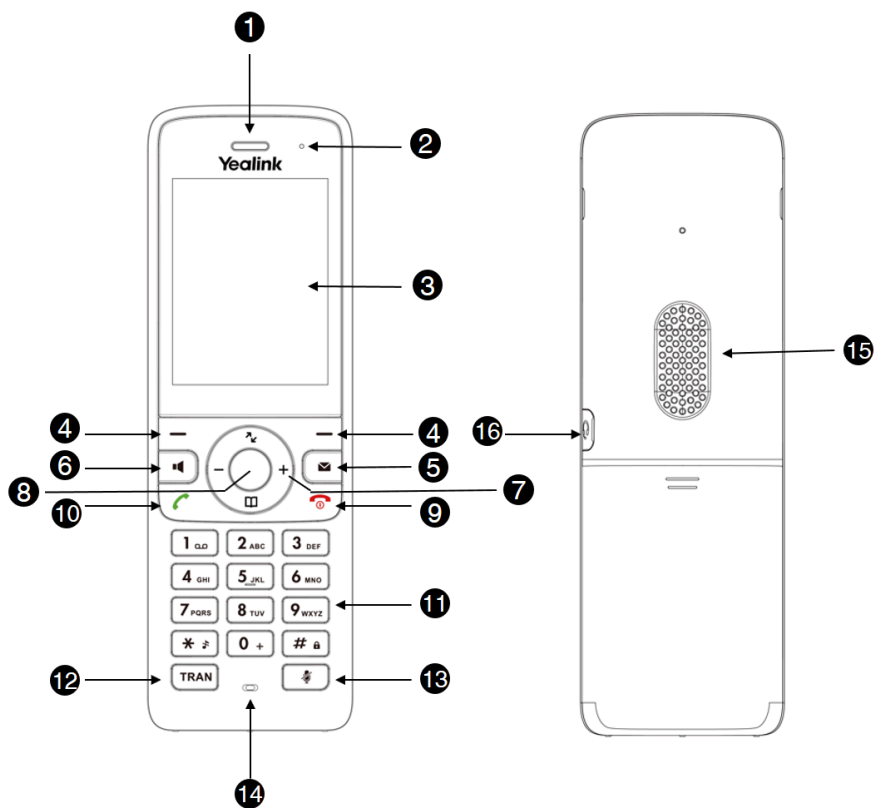

No.	Item	Description
1	Receiver	Receives audio in receiver mode.
2	Power LED Indicator	Indicates call status, message status, and charging status.
3	Phone Screen	Shows information.
4	Soft Keys	Access the function directly. It depends on the operating situation.
5	Message Key	Accesses the voice mail or missed call.
6	Speakerphone Key	<ul style="list-style-type: none"> <li>• Switches among the receiver, headset, and handsfree modes.</li> <li>• Answers an incoming call.</li> <li>• Places a call in handsfree mode.</li> </ul>
7	Navigation Keys	Scroll through information or options on the screen.
8	OK Key	Confirms actions or enters the main menu.
9	On-hook Key/Power Key	<ul style="list-style-type: none"> <li>• Press briefly to return to the previous screen.</li> <li>• Long press to return to the idle screen.</li> <li>• Press to turn the handset on.</li> <li>• Long press on the idle screen to turn the handset off.</li> <li>• Cancels actions or ends a call.</li> <li>• Rejects an incoming call.</li> </ul>
10	Off-hook Key	<ul style="list-style-type: none"> <li>• Answers an incoming call.</li> <li>• Enters the redial calls list.</li> <li>• Places a call in receiver or headset mode.</li> </ul>
11	Keypad	Provides digits, letters, and special characters.
12	TRAN Key	Transfers a call to another party.
13	Mute Key	Toggles mute feature on or off.
14	Microphone	Picks up audio.
15	Speaker	Plays audio in handsfree mode.
16	3.5 mm Headset Jack	Connects a standard 3.5 mm headset.

## W57R Hardware

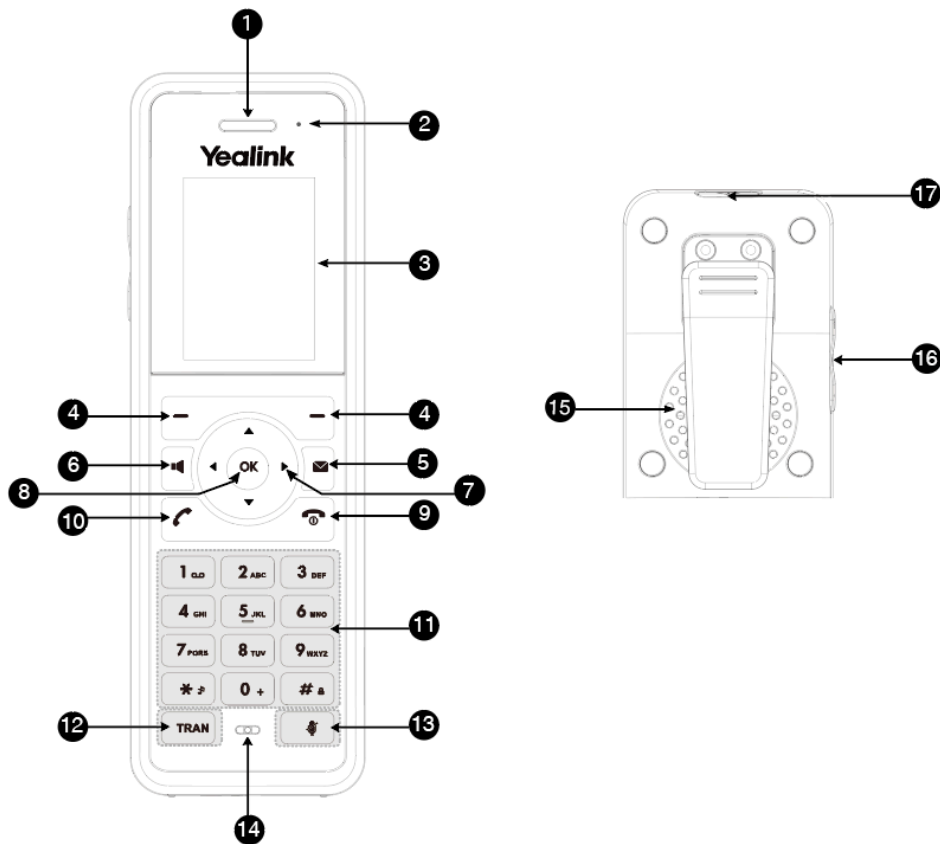

No.	Item	Description
1	Receiver	Receives audio in receiver mode.
2	Power LED Indicator	Indicates call status, message status, and charging status.
3	Phone Screen	Shows information.
4	Soft Keys	Access the function directly. It depends on the operating situation.
5	Message Key	Accesses the voice mail or missed call.
6	Speakerphone Key	<ul style="list-style-type: none"> <li>Switches among the receiver, headset, and handsfree modes.</li> <li>Answers an incoming call.</li> <li>Places a call in handsfree mode.</li> </ul>
7	Navigation Keys	Scroll through information or options on the screen.
8	OK Key	Confirms actions or enters the main menu.
9	On-hook Key/Power Key	<ul style="list-style-type: none"> <li>Press briefly to return to the previous screen.</li> <li>Long press to return to the idle screen.</li> <li>Press to turn the handset on.</li> <li>Long press on the idle screen to turn the handset off.</li> <li> Cancels actions or ends a call.</li> <li>Rejects an incoming call.</li> </ul>

No.	Item	Description
10	Off-hook Key	<ul style="list-style-type: none"> <li>Answers an incoming call.</li> <li>Enters the redial calls list.</li> <li>Places a call in receiver or headset mode.</li> </ul>
11	Keypad	Provides digits, letters, and special characters.
12	TRAN Key	Transfers a call to another party.
13	Mute Key	Toggles mute feature on or off.
14	Microphone	Picks up audio.
15	Speaker	Plays audio in handsfree mode.

### W59R Hardware

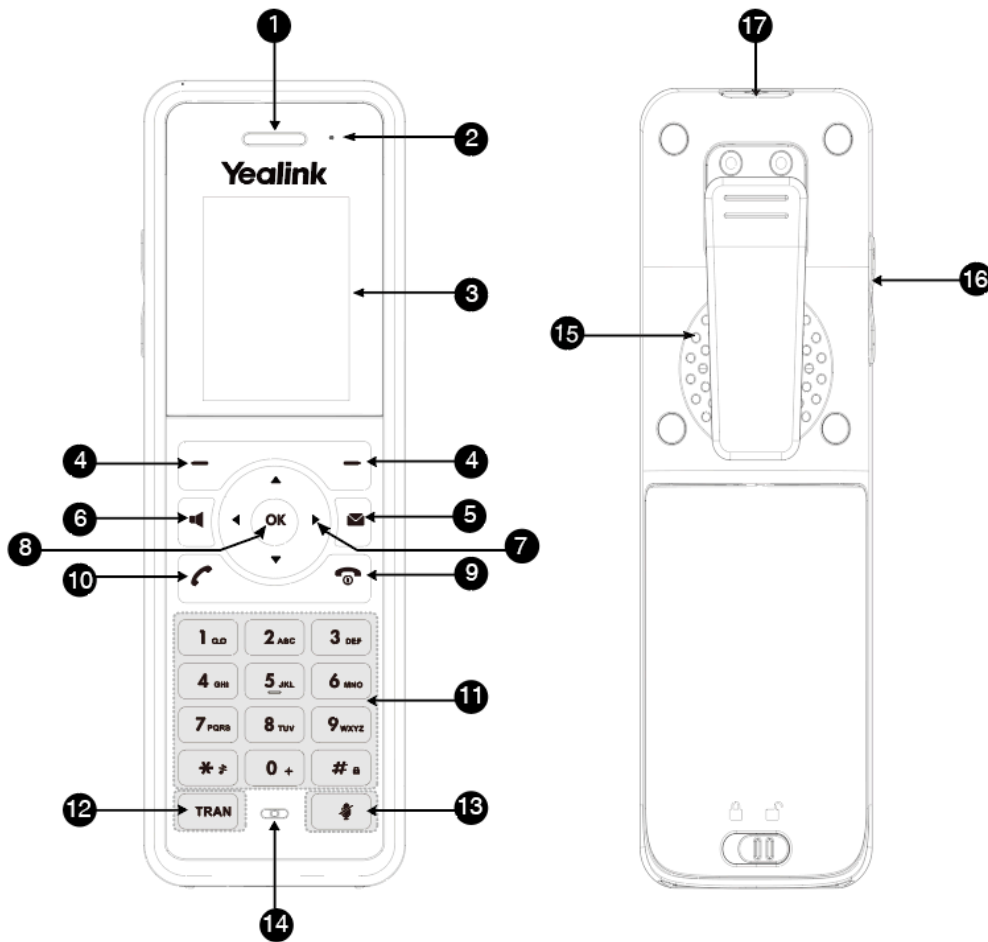



No.	Item	Description
1	Receiver	Receives audio in receiver mode.
2	Power LED Indicator	Indicates call status, message status, and charging status.
3	Phone Screen	Shows information.
4	Soft Keys	Access the function directly. It depends on the operating situation.

No.	Item	Description
5	Message Key	Accesses the voice mail or missed call.
6	Speakerphone Key	<ul style="list-style-type: none"> <li>• Switches among the receiver, headset, and handsfree modes.</li> <li>• Answers an incoming call.</li> <li>• Places a call in handsfree mode.</li> </ul>
7	Navigation Keys	Scroll through information or options on the screen.
8	OK Key	Confirms actions or enters the main menu.
9	On-hook Key/Power Key	<ul style="list-style-type: none"> <li>• Press briefly to return to the previous screen.</li> <li>• Long press to return to the idle screen.</li> <li>• Press to turn the handset on.</li> <li>• Long press on the idle screen to turn the handset off.</li> <li>• Cancels actions or ends a call.</li> <li>• Rejects an incoming call.</li> </ul>
10	Off-hook Key	<ul style="list-style-type: none"> <li>• Answers an incoming call.</li> <li>• Enters the redial calls list.</li> <li>• Places a call in receiver or headset mode.</li> </ul>
11	Keypad	Provides digits, letters, and special characters.
12	TRAN Key	Transfers a call to another party.
13	Mute Key	Toggles mute feature on or off.
14	Microphone	Picks up audio.
15	Speaker	Plays audio in handsfree mode.

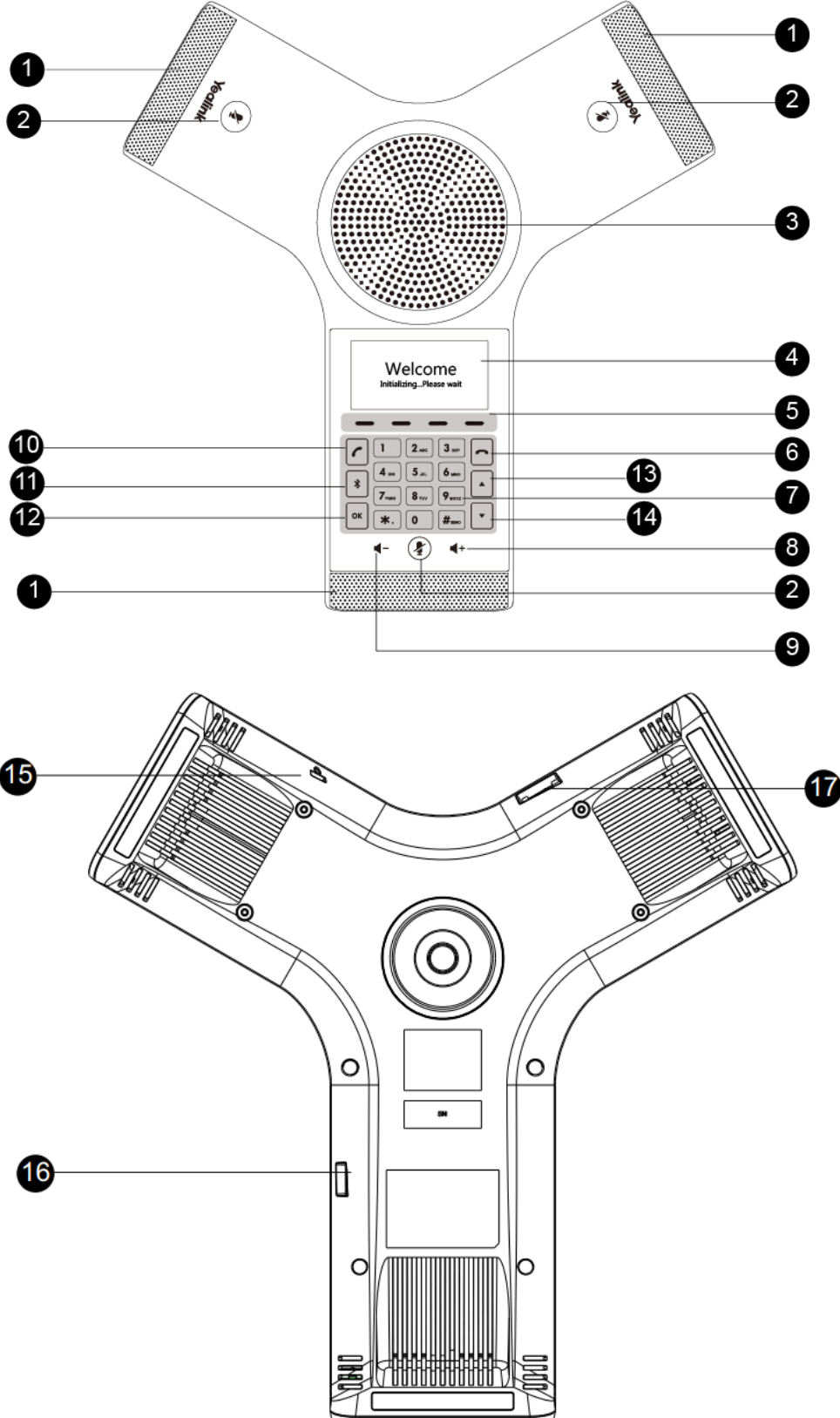
### CP930W Hardware



No.	Item	Description
1	Three Internal Microphones	Provide 20-feet (6 meters) and 360-degree sound pickup.
2	Mute Touch Key	<ul style="list-style-type: none"> <li>• Toggles mute feature.</li> <li>• Indicates phone and call status.</li> </ul>
3	Speaker	Provides speakerphone audio output.
4	LCD Screen	Shows information about calls, messages, soft keys, time, date and other relevant data.
5	Soft Keys	Labeled automatically to identify their context-sensitive features.
6	On-hook Key	Ends a call, returns to the idle screen or turns off the phone.
7	Touch Keypad	Provides the digits, letters, and special characters in context-sensitive applications. It is possible to open a menu option directly by tapping the number button that corresponds to the position of the option in the menu.
8	Volume Key(+)	Increases the volume of the speaker, ringer, or media.
9	Volume Key(-)	Decreases the volume of the speaker, ringer, or media.
10	Off-hook Key	Enters the dialing screen, places a call or answers a call.
11	Bluetooth Key	Enters the Bluetooth setting screen.
12		Confirms actions or answers incoming calls.
13		Scrolls through the displayed information upwards.
14		<ul style="list-style-type: none"> <li>• Scrolls through the displayed information downwards.</li> <li>• Views the Directory list when the phone is idle.</li> </ul>
15	Security Slot	Allows you to connect a universal security cable to your phone so you can lock down your phone. The phone will not be removed after locked.
16	Micro USB Port	Allows you to connect a PC and turn your phone into an external speaker and microphone for your PC.
17	Micro SD Slot	Allows you to connect an SD card to record calls and play recordings on the phone.

### CP935W Hardware

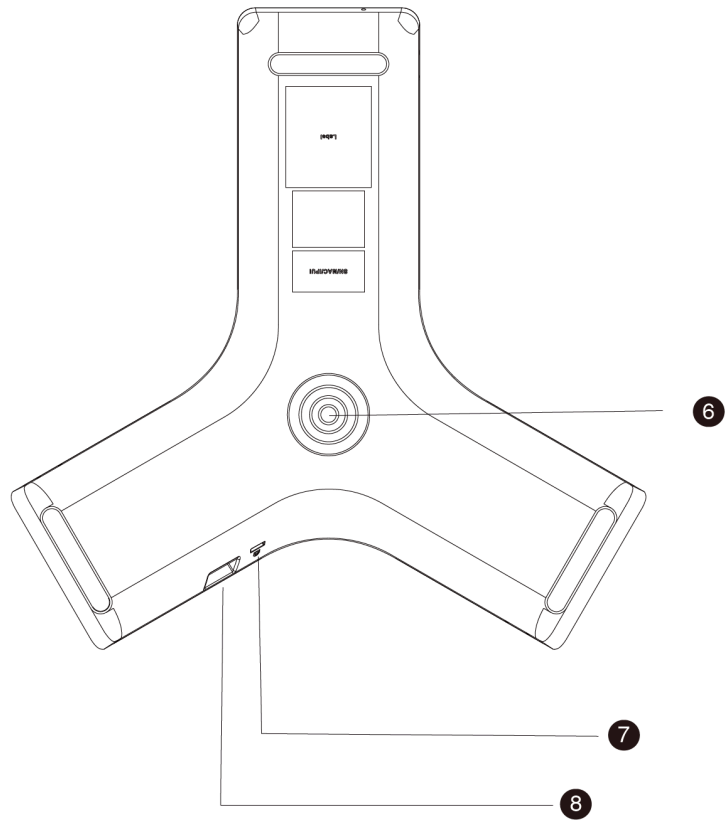
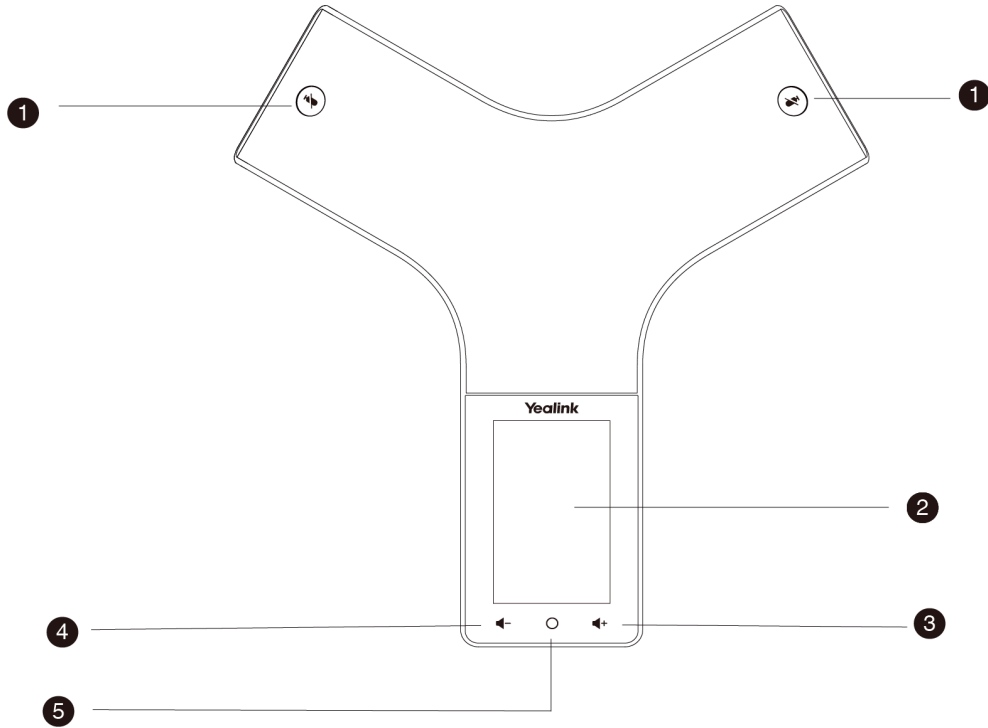

No.	Item	Description
1	Mute Key	<ul style="list-style-type: none"> <li>Toggles mute feature.</li> <li>Indicates phone and call status.</li> </ul>
2	Touch Screen	Shows information about calls, soft keys, time, date, and other relevant data.
3	Volume Key(+)	Increases the volume of the speaker, ringer, or media.
4	Volume Key(-)	Decreases the volume of the speaker, ringer, or media.
5	Home Touch Key	Returns to the idle screen.
6	Contact Charging Port	Connects the charging cradle to charge the phone.
7	Security Slot	Allows you to connect a universal security cable to your phone so you can lock down your phone. The phone will not be removed after locked.
8	USB Type-C Port	<ul style="list-style-type: none"> <li>Allows you to connect a USB flash drive (optional) to your phone so you can record calls/conferences and play back recorded files.</li> <li>Allows you to charge the Bluetooth Wireless Microphone CPW25.</li> </ul>

### DD Phone Hardware

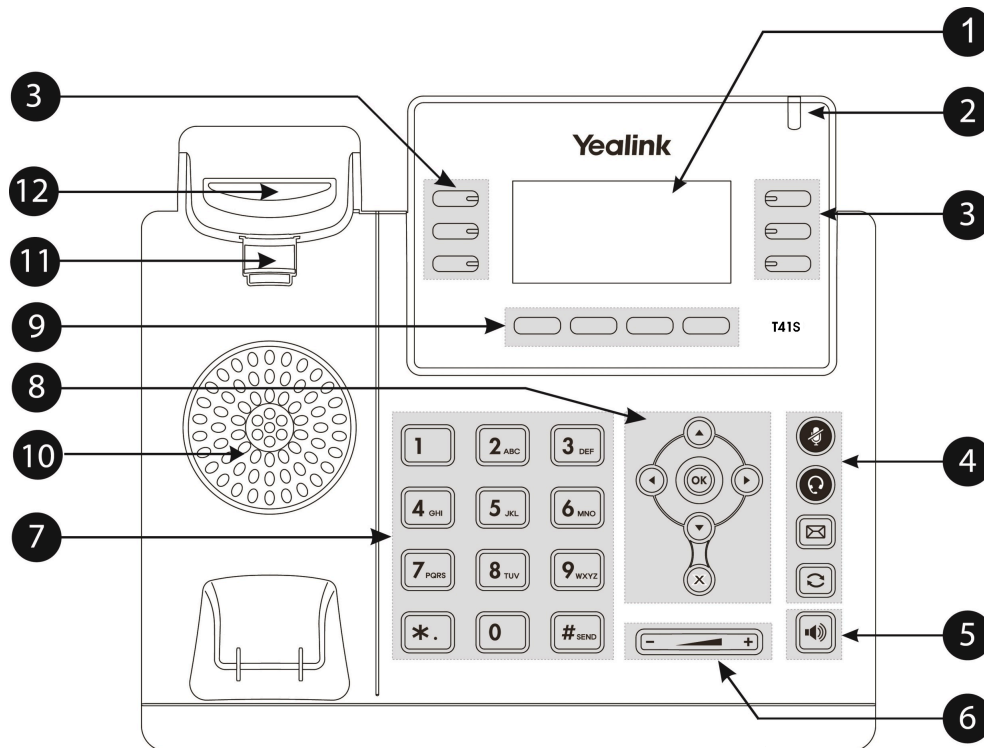

NO.	Item	Description
1	Phone Screen	Shows a screen with backlight that enables you to view menus and data.
2	Power LED Indicator	Indicates call status, message status, and system status.

NO.	Item	Description
3	Line Keys	Access your phone outgoing lines and features.
4	MUTE Key	Toggles the microphone on or off. The LED indicator glows red when the mute feature is activated.
	HEADSET Key	Toggles the headset on or off. The LED indicator glows green when the headset is activated.
	MESSAGE Key	Accesses your voice messages.
	REDIAL Key	Redials a previously dialed number.
5	Speakerphone Key	Toggles the speakerphone (hands-free) mode on or off. The LED indicator glows green when the speakerphone is activated.
6	Volume Key	Adjusts the volume of the handset, headset, and speaker.
7	Keypad Keys	Allow you to enter numbers, letters, and special characters. If a menu item has an index number, you can use the keypad keys to select the item.
8	Navigation Keys	<ul style="list-style-type: none"> <li>• Scroll through information or options displayed on the screen.</li> <li>• Access History and Directory respectively.</li> </ul>
	OK Key	Confirms actions or answers incoming calls.
	Cancel Key	Cancels actions or rejects incoming calls.
9	Soft Keys	Access the function displayed on the screen above the soft keys. The soft keys change depending on what you are doing at the time.
10	Speaker	Provides ringer and speakerphone audio output.
11	Reversible Tab	Secures the handset in the handset cradle when the phone is mounted vertically. For more information on how to adjust the reversible tab, refer to <a href="#">Yealink Wall Mount Quick Installation Guide for Yealink IP Phones</a> .
12	Hookswitch	Connects or disconnects the phone from the phone line. The hookswitch is automatically activated when a user lifts the handset from the cradle to get a dial tone.

DD Phone (Color Screen):

It is only applicable to W90/W80 multi-cell system.

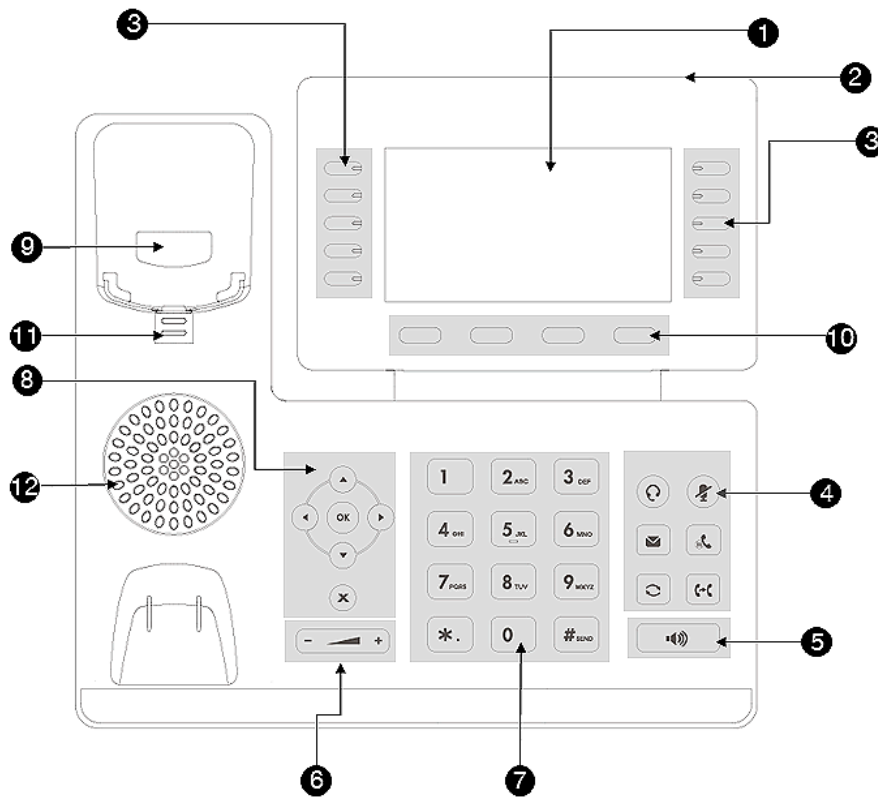

NO.	Item	Description
1	Phone Screen	Shows a screen with backlight that enables you to view menus and data.
2	Power LED Indicator	Indicates call status, message status, and system status.
3	Line Keys	Access your phone outgoing lines and features.
4	HEADSET Key	Toggles the headset on or off. The LED indicator glows green when the headset is activated.
	MUTE Key	Toggles the microphone on or off. The LED indicator glows red when the mute feature is activated.
	MESSAGE Key	Accesses your voice messages.
	HOLD Key	Places an active call on hold or resume the call.
	REDIAL Key	Redials a previously dialed number.
	FORWARD Key	Forward incoming calls of the line to another party.
5	Speakerphone Key	Toggles the speakerphone (hands-free) mode on or off. The LED indicator glows green when the speakerphone is activated.
6	Volume Key	Adjusts the volume of the handset, headset, and speaker.

NO.	Item	Description
7	Keypad Keys	Allow you to enter numbers, letters, and special characters. If a menu item has an index number, you can use the keypad keys to select the item.
8	Navigation Keys	<ul style="list-style-type: none"> <li>• Scroll through information or options displayed on the screen.</li> <li>• Access History and Directory respectively.</li> </ul>
	OK Key	Confirms actions or answers incoming calls.
	Cancel Key	Cancels actions or rejects incoming calls.
9	Hookswitch	Connects or disconnects the phone from the phone line. The hookswitch is automatically activated when a user lifts the handset from the cradle to get a dial tone.
10	Soft Keys	Access the function displayed on the screen above the soft keys. The soft keys change depending on what you are doing at the time.
11	Reversible Tab	Secures the handset in the handset cradle when the phone is mounted vertically. For more information on how to adjust the reversible tab, refer to <a href="#">Yealink Wall Mount Quick Installation Guide for Yealink IP Phones</a> .
12	Speaker	Provides ringer and speakerphone audio output.

### W56H/W53H Power LED Indicator

LED Status	Description
Solid red	The handset is charging.
Fast flashing red (300ms)	The handset is ringing.
Slowly flashing red (1s)	The handset receives a voice mail or has a missed call.
Off	<p>The handset is powered off.</p> <p>The handset is idle.</p> <p>The handset is fully charged.</p>

### CP930W Mute Touch Key LED Indicators

The Mute touch key LED indicators indicate the call and phone status.

LED Status	Description
Solid red	<p>The phone is initializing.</p> <p>The phone is muted.</p>
Flashing red	The phone is ringing.
Solid green	<p>The phone is placing a call.</p> <p>There is an active call on the phone.</p> <p>The call is placed on hold or is held (It is only applicable to the CP935W).</p>

LED Status	Description
Flashing orange	The phone prompts low battery or is charging.
Off	The phone is powered off. The phone is idle.

## Menu on the W56H/W53H





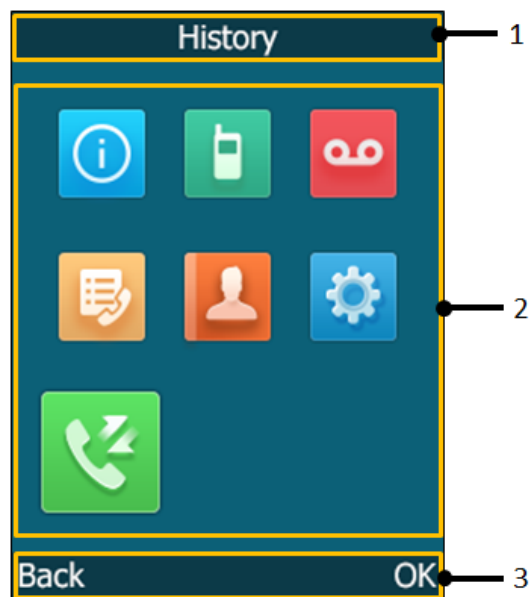

The handset provides a variety of features that are grouped into the menu.

- [Main Menu](#)
- [Submenu](#)
- [Returning to Idle Screen](#)

### Main Menu



No.	Description
1	Menu item you selected.

No.	Description
2	Menu icon:  : <b>Status</b> —To view the status information of DM, handset, and line.  : <b>Intercom</b> —Not available in the multi-cell system.  : <b>Voice Mail</b> —To set and view voice mail(s).  : <b>Call Features</b> —To access the features of <b>Call Forward</b> , <b>Do Not Disturb</b> , <b>Call Waiting</b> , <b>Anon.Call Rejection</b> , and <b>Anonymous Call</b> .  : <b>Directory</b> —To access the directory and manage the contacts.  : <b>Settings</b> —To personalize the setting of your handset.  : <b>History</b> —To access the call history list.
3	Soft key label.

- [Entering the Main Menu](#)
- [Accessing the Main Menu Feature](#)

### Entering the Main Menu

You can enter the main menu to view the features.

#### Procedure

Press the OK key when the handset is idle.

*The main menus are displayed on the screen as icons.*

### Accessing the Main Menu Feature

After entering the main menu, you can use the navigation keys to access the desired menu.

#### Procedure

1. Press the OK key when the handset is idle.  
*The main menus are displayed on the screen as icons.*
2. Press the navigation keys to select a different menu icon.  
*The name of the associated menu appears on the top of the screen.*
3. Press **OK** to open the selected menu.



**Note:** You can only access **Status** and **Settings** if the handset is not registered to a base station.

### Submenu

The functions in the submenus are displayed as lists. You can open the submenu to access a function.

For example, if you select the **Settings** menu, the submenu is displayed below:

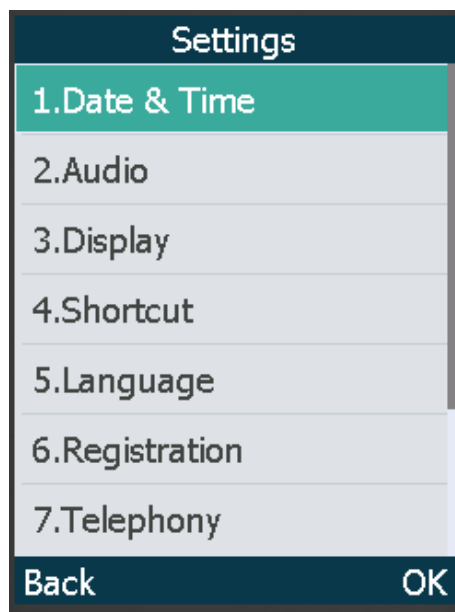

- [Accessing a Submenu Feature](#)

#### **Accessing a Submenu Feature**

After entering a certain menu, you can use the navigation keys to access the desired submenu.

#### **Procedure**

1. Press the up and down navigation keys to highlight the desired submenu.
2. Press **OK** to open the submenu.
3. Press the On-hook key or **Back** to return to the previous screen.

## **Returning to Idle Screen**

#### **Procedure**

Long press the On-hook key to quickly exit the menu and return to the idle screen.

## **Screen and Icons**

---

The user screens and icon indicators can help you navigate and understand the important information on the phone's status.

- [Idle Screen](#)
- [CP930W/DD Phone Calls Screen](#)
- [Icons on the Idle Screen](#)
- [W56H/W53H Line Status Screen](#)
- [W56H/W53H Icons on the Calls Screen](#)
- [W56H/W53H Icons on the Line Status Screen](#)

### **Idle Screen**

The idle screen is made up of the signal strength, battery status, status bar, handset name, and soft keys. The time & date is displayed in the middle of the screen.

On the CP930W/DD phone, the default account also displays on the idle screen.

**W56H/W53H:**

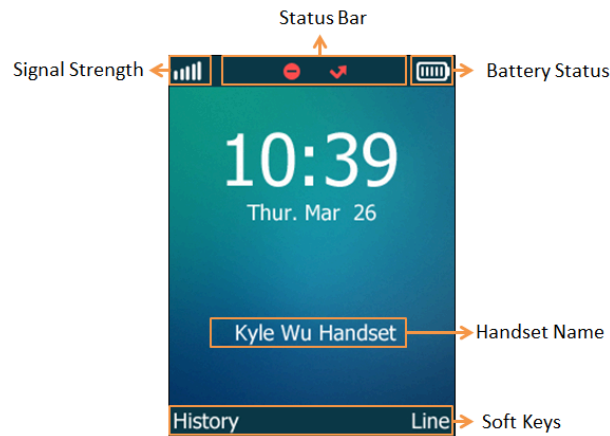

**CP930W:**



**DD Phone (Black-and-White Screen):**

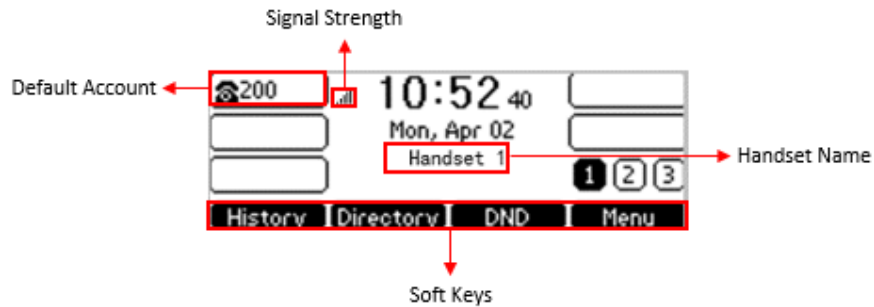

- **Default Account:** Indicates the local name or number.
- **Signal Strength:**

Weak to strong: [Signal strength icons] (W56H/W53H), [Signal strength icons] (CP930W), [Signal strength icons] (DD phone)

No reception: [No reception icons] (W56H/W53H), [No reception icons] (CP930W), [No reception icons] (DD phone)

- **Battery Status:**

Low to full: [Battery icons] (W56H/W53H), [Battery icons] (CP930W)

Need Charging: [Need charging icons] (W56H/W53H), [Need charging icons] (CP930W)

- **Status Bar:** Displays the feature status icons. The status icons are displayed when features are activated.

- **Handset Name:** Displays the registered handset name.
- **Soft Keys:** The soft key labels on the screen directly above the soft keys show the functions available at that particular moment.

### CP930W/DD Phone Calls Screen

All of your active and held calls are displayed on the calls screen.

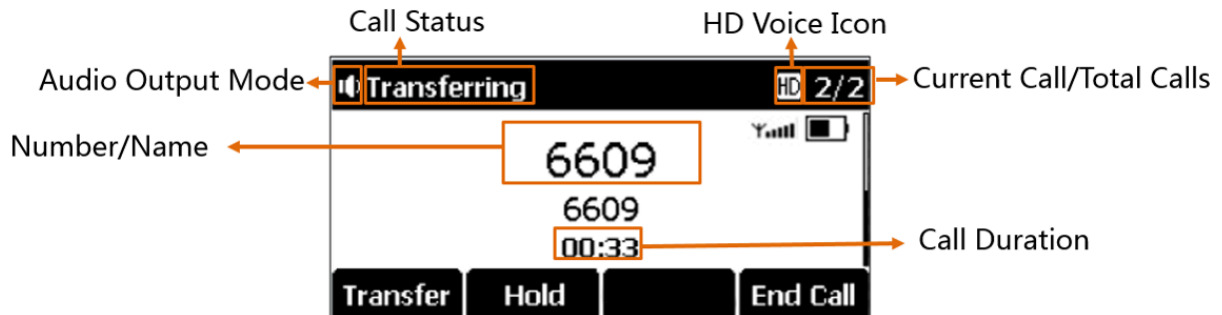

### Icons on the Idle Screen



By viewing the icons on the idle screen, you can easily get the current phone status, such as message status.

#### W56H/W53H:











Icons	Description	Icons	Description
	The ringer volume is 0 and the phone is in the silent mode.		The phone has new voice mails.
	The phone has enabled the Call Forward feature.		The phone has enabled the Do Not Disturb (DND) feature.
	The keypad is locked.		

#### CP930W:

Icons	Description	Icons	Description
	The ringer volume is 0 and the phone is in the silent mode.		The phone has enabled the Do Not Disturb (DND) feature.
	The phone has enabled the Call Forward feature.		The phone has new voice mails.
	The keypad is locked.		The phone failed to register to a base station.
	The phone is in the Speakerphone (hands-free) mode.		The Bluetooth-enabled mobile phone is paired and connected to the phone.
	The phone has registered to a base station successfully.		The SD card is connected to the phone.
	The phone has enabled the Bluetooth feature.		The battery is not inserted into the phone.

Icons	Description	Icons	Description
	The phone is recording a call or a conference.		The phone has missed calls.
	The recording is paused.		

#### DD Phone:

Icons	Description	Icons	Description
	The ringer volume is 0 and the phone is in the silent mode.	<b>DND</b>	The phone has enabled the Do Not Disturb (DND) feature.
	The phone has enabled the Call Forward feature.		The phone has new voice mails.
	The phone is in the handset mode.		The phone has missed calls.
	The phone is in the headset mode.		The phone is locked.
	The phone is in the Speakerphone (hands-free) mode.		The private line registers successfully.
	The shared line registers successfully.		

## W56H/W53H Line Status Screen

The line status screen is made up of the line and line status.



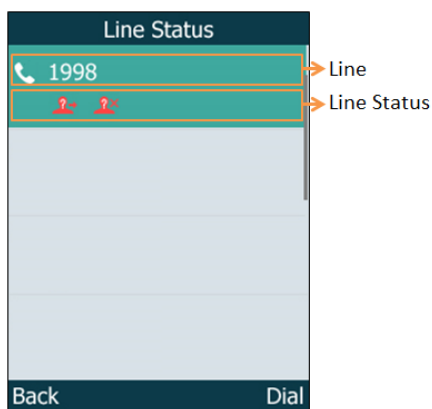



When the handset is idle, you can press **Line** to enter the line status screen. The line status screen is displayed below:



- **Line:** Display the corresponding line (display user name by default).
- **Line Status:** Display the icon of line status. The icon indicates the corresponding feature assigned to the line.





## W56H/W53H Icons on the Calls Screen

By viewing the icons in the calls screen, you can easily get the current call status, such as audio output mode status.

Icons	Description	Icons	Description
	Receiver Mode On		Headset Mode On
	Handsfree Mode On		Contact
	Call Hold		Call Mute
	Conference Call		

## W56H/W53H Icons on the Line Status Screen

Each icon in the line status screen indicates the corresponding feature assigned to the line.

Icons	Description	Icons	Description
	Call Forward		Do Not Disturb (DND)
	Anonymous call rejection is enabled		Anonymous call is enabled

## Rechargeable Battery

---

The CP930Wphone comes with a charged battery, but it may need recharging to full capacity depending on how long it has been in storage.

A fully-charged battery provides talk time of about 24 hours or 15 days of standby time.

- [Viewing the Power Status](#)

### Viewing the Power Status

When the phone is idle, you can check the battery's remaining capacity.

#### Procedure

Go to **Menu > Status > Power Status**.

The screen shows the remaining talk time and standby time.

## Entering Characters

---

You can enter and edit data in the corresponding field using the keypad.

- [Setting the Input Modes](#)
- [Entering Data on the W56H/W53H](#)
- [Entering Data on the CP930W/DD Phone](#)

### Setting the Input Modes

The handset provides you with 12 input modes, and different input mode provides different characters. The default input modes are Abc, 123, ABC and abc. You can enable the input modes used frequently.

**About this task**

It is not applicable to DD phones.

**Procedure**

1. Go to **OK > Settings > Display > Input Method**.

On the CP930W, go to **Menu > Settings > Basic Settings > Display > Input Method**.

2. Select the desired input mode and then select **Change**.

**Related information**

[Appendix B - Input Modes and Characters](#)

**Entering Data on the W56H/W53H**



The following table describes how to enter different characters using the keypad keys:

Task	Action
Switch among input modes.	Press <b>[#*]</b> to switch among input modes. The current input mode is displayed at the right bottom of the phone screen.
Enter letters.	Press a key one or more times (depending on what input mode you're in) to enter the possible characters that are displayed on the keypad key.
Enter special characters.	Press <b>[*#]</b> to enter the space character or the following special characters: _ ' " = / \ ^ ; : , . - + * # \$ % & @ ? ! ; i ( ) { } [ ] < > ¥ £ \$   ~ □ Press <b>[0+]</b> : <ul style="list-style-type: none"> <li>• If it is in the uppercase (ABC), uppercase and lowercase (Abc) or lowercase (abc) input modes, it will provide space character and the following special characters: . , ? ! 0</li> <li>• If it is in the numeric (123) input mode, it will only provide the digit 0.</li> <li>• Long press the key to enter the character +.</li> </ul>
Delete the text.	Press <b>[←]</b> or <b>[→]</b> to position the cursor to the right of the text you want to delete, and then press <b>Delete</b> to delete one character at a time or long press to delete all characters.

**Entering Data on the CP930W/DD Phone**

The following table describes how to enter different characters using the keypad keys.

Task	Action
Switch input modes	Press the <b>ABC</b> , <b>abc</b> , <b>Abc</b> , <b>2aB</b> , or <b>123</b> soft key to switch the input modes.
Enter letters	Select <b>ABC</b> , <b>abc</b> , <b>2aB</b> , or <b>Abc</b> mode. On the DD phones, press the keys labeled with letters until your desired letter appears. On the CP930W, press a keypad key repeatedly to view the character options and stop when the letter you want to enter is displayed in the field. Wait one second, and then enter the next letter.
Enter numbers	Select <b>123</b> mode and press the corresponding keys.

Task	Action
Enter special characters	<p>Select <b>ABC</b>, <b>abc</b>, <b>2aB</b>, or <b>Abc</b> mode, press * key or # key one or more times to enter one of the following special characters:</p> <p>* key (DD phone): *,'?! \-() @/:_+&amp;%=&lt;&gt; £ \$ ¥ ¢ [] {} ~ ^ ¡ ¢ \$ # "  </p> <p>* key (CP930W): *,'?! \-() @/:_+&amp;%=&lt;&gt; \$ [] {} ~</p> <p># key: #</p> <p>On the DD phone, in <b>123</b> mode, you can press the * key to choose the following special characters: .*/@[].</p>
Insert space	Select <b>ABC</b> , <b>abc</b> , <b>2aB</b> , or <b>Abc</b> mode, press the <b>0</b> key.
Move cursor	On the DD phone, press  or  to position the cursor.
Delete one or more characters	<p>On the DD phone, position the cursor to the right of the character, and select the <b>Delete</b> soft key.</p> <p>On the CP930W, press the <b>Delete</b> soft key.</p>



**Note:** 2aB is only applicable to the DD phone.

## Registering the Handset

---

You need to register your handset to the DECT manager (DM) if you want to use the basic functions of the DECT multi-cell system.

- [Possible Reasons for Registration Failure](#)
- [Registering Handsets at the DECT Manager](#)
- [Selecting a System to Connect](#)

### Possible Reasons for Registration Failure

---

Some scenarios may cause registration failure.

- Incorrect base PIN (check with your system administrator).
- Base station is out of range.
- Base station is not in registration mode.



**Note:** If registration was not successful, the handset screen will prompt you that the registration is failed.

### Registering Handsets at the DECT Manager

---

After your system administrator has set the DM to the registration mode, you can register handsets to the DM.

#### Procedure

Do one of the following:

- Press the **Reg** soft key on the handset to register quickly.
- Press **OK > Register Handset** and then select the desired base to register the handset.
- Go to **OK > Settings > Registration > Register Handset** and then select the desired base to register the handset.

*After registration, the handset prompts “Handset Subscribed”.*



**Note:** The default base PIN is 0000.

## Selecting a System to Connect

---

You can connect the handset to a desired system manually, or allow the handset to connect the registered system with the greatest signal strength automatically.

### About this task

It is only applicable to W56H/W53H.

### Procedure

1. Go to **OK > Settings > Registration > Select Base**.  
The phone screen displays all systems that the handset is registered to and the **BestBase** option.
2. Select the desired system or **BestBase**, and then press **Select**.

## Call Features

---

You can use the phone to place and answer calls, ignore incoming calls, transfer a call to someone else, conduct a conference call and perform other basic call features.

- [Placing Calls](#)
- [Answering Calls](#)
- [Disabling Call Waiting](#)
- [Silencing or Rejecting Incoming Calls](#)
- [Ending Calls](#)
- [Muting/Unmuting Audio](#)
- [Holding and Resuming Calls](#)
- [Call Forward](#)
- [Transferring Calls](#)
- [Conference Calls](#)
- [Recording Using an SD Card](#)

## Placing Calls

---

After the handset is registered successfully, you can use your handset to place an external call.

The handset can keep 2 calls at one time at almost, one (associated with the audio) active and the other one on hold.

- [Placing External Calls](#)
- [Placing a Call from the Call History](#)
- [Placing a Call from the Directory](#)

- [Speed Dial on the W56H/W53H](#)
- [Speed Dial on the DD Phone](#)
- [Redial](#)
- [Placing an Anonymous Call](#)

## Placing External Calls

You can place external calls on the handset. External calls based on the public telephone network require the SIP lines.

- [Placing an External Call](#)
- [Placing Multiple External Calls](#)

### Placing an External Call

#### Procedure

1. Enter the desired number using the keypad.
2. Press the **OK** key to dial out.

### Placing Multiple External Calls

When you are in a call, you can hold your current call and place a new call.

#### Procedure

1. Select **New Call**.

On the CP930W/DD phone, select **Hold > New Call**.

2. Enter the contact number and press the **OK** key.



**Note:** You can select **Options > Directory** to select a contact from the directory to dial out. On the CP930W/DD phone, select **Hold > New Call > Directory**.

## Placing a Call from the Call History

You can place calls to contacts from the History list, which contains the calls that were recently placed, answered, or missed.

#### Procedure

1. Press **History**.
2. Select the desired call list.
3. Highlight a contact and press the **Off-hook** key.

## Placing a Call from the Directory

You can place a call to a contact directly from your directory.

#### Procedure

1. Go to **OK > Directory**.

On the CP930W/DD phone, select **Directory** or **Menu > Directory**.

2. Select the desired directory.
3. Highlight the desired contact and press the **Off-hook** key or **Send**.

If the selected contact has multiple numbers, highlight the desired number, and select **OK**.

## Speed Dial on the W56H/W53H

You can quickly dial a number by using a speed dial key without entering the directory.

- [Assigning a Speed Dial Number](#)
- [Changing a Speed Dial Number](#)
- [Deleting a Speed Dial Number](#)
- [Calling a Contact Using a Speed Dial Key](#)

### Assigning a Speed Dial Number

You can assign a contact number as a speed dial number to the digit key. A maximum of 8 speed dial numbers are allowed.

#### Before you begin

The assigned number should exist in the directory.

#### Procedure

1. Go to **OK > Settings > Telephony > Speed Dial**.  
The phone screen displays all available speed dial keys (2-9).
2. Highlight the desired digit key, and then press **Assign**.
3. Select the desired contact from the directory.
4. Press **OK** to assign the number to the selected Speed Dial key.  
If the selected contact has multiple numbers, select the desired number, select **OK**.

### Changing a Speed Dial Number

You can change the current speed dial number to a new desired one.

#### Before you begin

The assigned number should exist in the directory.

#### Procedure

1. Go to **OK > Settings > Telephony > Speed Dial**.
2. Highlight an assigned Speed Dial key.
3. Select **Options > Change**.
4. Select a contact number from the directory.
5. Press **OK** to change the assigned speed dial number.

### Deleting a Speed Dial Number

When you no longer use the speed dial number, you can delete it.

#### Procedure

1. Go to **OK > Settings > Telephony > Speed Dial**.
2. Highlight the desired Speed Dial key.
3. Select **Options > Clear Key**.

### Calling a Contact Using a Speed Dial Key

After you have assigned the speed dial number, you can place a call to a contact directly by pressing it.

#### Procedure

Long press the Speed Dial key when the handset is idle.

The number assigned to this Speed Dial key is dialed out.

#### Related tasks

[Assigning a Speed Dial Number](#)

## Speed Dial on the DD Phone

You can quickly dial a number by using a speed dial key without entering the directory.

- [Configuring a Speed Dial Key](#)

### Configuring a Speed Dial Key

You can set a line key as a Speed Dial key for a contact number.

#### Procedure

1. Go to **Menu > Features > Dsskey**.
2. Select the desired line key.
3. Select the **SpeedDial** from the **Type** field.
4. Optional: Enter the string that will appear on the LCD screen in the **Label** field.
5. Enter the number you want to dial out in the **Value** field.
6. Confirm the action.

## Redial

You can redial a call from the redial list.

For W56H/W53H, the redial list stores the last twenty dialed phone numbers. For DD phone, the redial list stores the last eighteen dialed phone numbers. When the memory of the redial list is full, the handset will automatically erase the oldest one when a new number is dialed.

It is not applicable to CP930W/CP935W.

- [Redialing a Number](#)
- [Redialing the Last Dialed Number](#)
- [Adding a Dialed Number to Local Directory](#)
- [Deleting a Redial Record](#)
- [Deleting All Redial Records](#)

### Redialing a Number

The handset keeps a record of all the placed calls. You can call the recently dialed phone number.

#### Procedure

1. Press  when the handset is idle to access the redial list.

On the DD phone, press  when the phone is idle to access the redial number list.

2. Select a record to dial out.



**Note:** Before placing an external call on W56H/W53H, you can select **Options > Edit Before Call** to edit the phone number.

### Redialing the Last Dialed Number

#### Procedure

Press  twice when the handset is idle.

On the DD phone, press  twice.

*A call to your last dialed number is attempted.*

### Adding a Dialed Number to Local Directory

You can add a dialed external call number to the Local Directory or update the number for an existing contact.

#### About this task

It is only applicable to W56H/W53H.

#### Procedure

1. Press  when the handset is idle to access the redial list.
2. Highlight the desired record.
3. Press **Options**, and then select **Add To Local > New Entry**.
4. Select the type you want to add the number to.
5. Edit the corresponding fields.
6. Confirm the action.



**Note:** You can select **Add To Local > Update Existing** to add the number to an existing contact or update the existing contact information.

### Deleting a Redial Record

You can delete any record from the redial list.

#### Procedure

1. Press  when the handset is idle to access the redial list.

On the DD phone, press  when the phone is idle to access the redial number list.

2. Highlight the desired record.
3. Press **Options** and select **Delete**.

On the DD phone, select **Delete**.

### Deleting All Redial Records

You can delete all redial records at once.

#### Procedure

1. Press  when the handset is idle to access the redial list.

On the DD phone, press  when the phone is idle to access the redial number list.

2. Select **Options > Delete All**, and select **Yes** to confirm.

On the DD phone, select **Delete All**.

## Placing an Anonymous Call

You can hide your name and number when you place a call. As a result, the callee receives an anonymous call without caller identity.

**Before you begin**

Contact your system administrator to find out if this feature is available on your phone.

**Procedure**

1. Go to **OK > Call Features > Anonymous Call**.  
On the CP930W/DD phone, go to **Menu > Features > Anonymous Call**.

2. Enable local anonymous.

3. Confirm the action.

4. Place a call.

The callee is prompted with an incoming call from anonymity.

If the callee enables anonymous rejection feature, you may be prompted that the callee does not accept calls from an anonymous number.

## Answering Calls

---

When you receive a call, you can choose to answer it manually or automatically.



- [Answering a Call](#)
- [Answering a Call When in a Call](#)
- [Answering a Call Automatically](#)

### Answering a Call

When you receive an incoming call, the phone rings and the screen displays the information of the incoming call.

**Procedure**

Do one of the following:

- Press , or press **Accept** or **Answer**.
- Press the Speakerphone key.
- If a headset is connected, press **Accept** or the HEADSET key .

### Answering a Call When in a Call

You can answer a call when there is already an active call on your phone.

When you are in an active call and an incoming call arrives on the phone, a call waiting tone beeps, and the incoming call information is displayed.

**Procedure**

1. On the W56H/W53H, press the down navigation key to select the incoming call.
2. Select **Accept** or **Answer**.

**Results**

The active call is placed on hold, and the incoming call becomes active.



**Note:** You can disable the call waiting feature to reject the incoming call automatically during a call.

**Related tasks**

[Disabling Call Waiting](#)

## Answering a Call Automatically

When the handset is placed in the charger, you can simply answer the incoming calls by picking up the handset from the charger without pressing the Off-hook key.

### About this task

It is only applicable to W56H/W53H.

### Procedure

1. Go to **OK > Settings > Telephony > Auto Answer**.
2. Press **Change** to select the **Auto Answer** check box (the default status is checked).

## Disabling Call Waiting

---

If the call waiting feature is disabled, when there is already a call, the new incoming call will be rejected automatically.

### Procedure

1. Go to **OK > Call Features > Call Waiting**.  
On the CP930W/DD phone, go to **Menu > Features > Call Waiting**.
2. Disable call waiting.
3. Confirm the action.

## Silencing or Rejecting Incoming Calls

---

When you receive an incoming call, you can choose to silence or reject the call instead of answering.

- [Silencing a Call](#)
- [Rejecting a Call Manually](#)
- [Rejecting Anonymous Calls](#)
- [Rejecting Calls with Do Not Disturb \(DND\)](#)

### Silencing a Call

You can silence a call to stop your phone from ringing. Even if you silence the call, the incoming call notification continues to be displayed on your phone.

### Procedure

Select **Silence**.

### Rejecting a Call Manually

You can reject a call manually, and the call may be sent to voice mail. The rejected calls are displayed in the Received Calls list in your History list.

### Procedure

Press  or **Reject**.

## Rejecting Anonymous Calls

You can reject incoming calls from the callers who have hidden their identities. As a result, your phone will not ring and you will not be notified of an attempted call.

### Procedure

1. Go to **OK > Call Features > Anon.Call Rejection**.  
On the CP930W, go to **Menu > Features > Anon.Call Rejection**.  
On the DD phone, go to **Menu > Features > Anonymous Call**.
2. Enable local anonymous rejection.
3. Confirm the action.

## Rejecting Calls with Do Not Disturb (DND)

You can enable DND to reject all incoming calls automatically when you do not want to be interrupted.

### Before you begin

Check with your system administrator to find out if the DND feature is available on your phone.

### Procedure

1. Go to **OK > Call Features > Do Not Disturb**.  
On the CP930W/DD phone, go to **Menu > Features > DND**.
2. Enable DND.
3. Confirm the action.  
The status bar displays the DND icon.



**Note:** On the CP930W/DD phone, to activate or deactivate DND quickly, select **DND** when the phone is idle.

## Ending Calls

---

You can end the current call at any time.

### Procedure

Press  or **End Call**.

## Muting/Unmuting Audio

---

You can mute the microphone during an active call so that the other party cannot hear your discussion with your colleagues.

### Procedure

1. Press the mute key during a call to mute the microphone.  
The mute icon appears on the phone screen. On the CP930W/CP935W, the mute touch key LEDs change from green to red.

2. Press the mute key again to unmute.  
The mute icon disappears from the phone screen. On the CP930W/CP935W, the mute touch key LEDs change from red to green.

## Holding and Resuming Calls

---

You can place an active call on hold and resume the call when you are ready. When you place a call on hold, the held party may hear the music played by its sever.

- [Holding a Call](#)
- [Resuming a Held Call](#)

### Holding a Call

You can place an active call on hold on your phone.

#### Procedure

During a call, select **Options** > **Hold**.

On the CP930W/DD phone, select **Hold**.



**Note:** When you have multiple calls on the phone and the current call is held, you can press the up or down navigation key to swap to the active call.

### Resuming a Held Call

You can view and resume a held call on the phone.

#### Procedure

Select **Resume**.

If multiple calls are placed on hold, select the desired call first.



**Note:** When you have multiple calls on the phone and the current call is active, you can press the up or down navigation key to swap to the held call.

## Call Forward

---

The handset will forward incoming calls to another party according to the forwarding type.

There are three forwarding types:

- **Always Forward:** Incoming calls are immediately forwarded. There is no prompt on the phone screen when the line receives an incoming call.
- **Busy Forward:** Incoming calls are forwarded when the line is busy.
- **No Answer Forward:** Incoming calls are forwarded if not answered after a period of time.
- [Forwarding Incoming Calls](#)

### Forwarding Incoming Calls

When you are not available to handle calls, you can forward incoming calls to a specific contact.

**Procedure**

1. Go to **OK > Call Features > Call Forward**.  
On the CP930W/DD phone, go to **Menu > Features > Call Forward**.
2. Select the desired forwarding type and enable it.
3. Enter the destination number in the **Target** or **Forward to** field.
4. If you select the **No Answer (No Answer Forward)**, select the desired ring time to wait before forwarding from the **After Ring Time** field.
5. Confirm the action.

## Transferring Calls

---

During a call, you can transfer the call to another contact.

You can use one of three ways:

- **Blind Transfer:** Transfer a call directly to the third party without consulting.
- **Semi-Attended Transfer:** Transfer a call when receiving ringback.
- **Attended Transfer (Consultative Transfer):** Transfer a call with prior consulting.
- [Performing a Blind Transfer](#)
- [Performing a Semi-Attended/Attended Transfer](#)

### Performing a Blind Transfer

You can transfer a call to another contact immediately without consulting with her/him first.

**Procedure**

1. Select **Options > (Call) Transfer**, or press the TRAN key during a call.  
On the CP930W/DD phone, select **Transfer**.
2. Enter the number you want to transfer the call to or select **Directory** to choose a contact.
3. Press TRAN or **Transfer** to complete the transfer.  
On the CP930W/DD phone, select **B Trans**.

### Performing a Semi-Attended/Attended Transfer

You can transfer a call to another contact immediately when receiving ringback or after consulting with her/him first.

**Procedure**

1. Select **Options > (Call) Transfer**, or press the TRAN key during a call.  
On the CP930W/DD phone, select **Transfer**.
2. Enter the number you want to transfer to and dial out.

## Conference Calls

---

The phone supports creating a conference with other two external parties and multi-way network conference.

During the conference, follow these tips:

- Mute your microphone when you are not speaking, especially in noisy environments.
- Avoid tapping or rustling papers near the microphone.
- Speak in your normal voice without shouting.
- [Local Conference](#)
- [Hybrid UC Meeting](#)
- [Network Conference](#)

## Local Conference

You can initiate a three-way (including yourself) conference calls with your contacts on the phone.

- [Setting Up a Local Conference Call](#)
- [Merging Two Calls into a Conference](#)
- [Splitting a Conference Call](#)
- [Muting/Unmuting a Conference Call](#)
- [Ending a Conference Call](#)

### Setting Up a Local Conference Call

You can set up a local conference call with up to two contacts.

#### Procedure

1. Place a call to the first party.
2. When the first party answers the call, select **Options > Conference**.

On the CP930W/DD phone, select **Conference**.

*The active call is placed on hold.*

3. Dial the second party's number.
4. When the second party answers the call, select **Conf.** to invite two parties to join the conference.

On the DD phone, select **Conference**.

### Merging Two Calls into a Conference

You can invite a held call into a conference call with the active call.

#### Procedure

1. Place two calls on the phone.
2. Select **Options > Conference**.

On the CP930W/DD phone, select **Conf.**

### Splitting a Conference Call

You can split a conference call. After you split a conference, you end the conference call and place the other calls on hold.

#### About this task

It is only applicable to CP935W and CP930W.

#### Procedure

1. Place a conference call.

2. On the CP935W, select **☰** > **Split**.

On the CP930W, select **Manage** > **Split All**.

### Muting/Unmuting a Conference Call

When you mute the local microphone during a conference call, other participants can hear each other except you.

#### Procedure

1. Press the MUTE key to mute the conference.
2. Press the MUTE key again to unmute the conference.

### Ending a Conference Call

You can end the current conference call at any time.

#### Procedure

Press  or **End (End Call)**.

## Hybrid UC Meeting

You can create a hybrid UC meeting on the CP930W by different ways.

- [Creating a Hybrid UC Meeting with Mobile Phone](#)
- [Creating a Hybrid UC Meeting with PC](#)
- [Creating a Hybrid UC Meeting with Mobile Phone and PC](#)

### Creating a Hybrid UC Meeting with Mobile Phone

When you are talking on your mobile phone and want to invite colleagues, you can create a hybrid UC meeting on the phone.

#### Procedure

1. During the mobile call, active the Bluetooth feature on your mobile phone.
2. Connect and pair the phone on your mobile phone.
3. Switch the audio input mode to Bluetooth on your mobile phone.
4. Select **Conf**, then enter the desired number to dial out or press **Directory** to select a contact.
5. After the second party answers the call, select **Conf**.
6. Repeat steps 4-5 to invite more parties (up to 4 parties).

### Creating a Hybrid UC Meeting with PC

When you are talking with your contact on the PC and want to invite colleagues, you can create a hybrid UC meeting on the phone.



#### Procedure

1. Connect the phone to a PC using a micro USB cable.
2. Select **Hold** > **New Call**.
3. Enter the desired number to dial out or press **Directory** to select a contact.
4. After the second party answers the call, select **Conf**.
5. Repeat steps 2-4 to invite more parties (up to 4 parties).

### Creating a Hybrid UC Meeting with Mobile Phone and PC

You can create a hybrid UC meeting on the phone with mobile phone and PC simultaneously.

#### Procedure

1. Connect and pair the phone on your mobile phone.
2. Connect the PC to your phone by using the micro USB cable.
3. Place a call using the softphone on the PC.
4. Do the following to place a mobile call over Bluetooth on the phone.
  - a) Select **Hold > New Call**.
  - b) Select **Switch** to choose the **Mobile Account**.
  - c) Enter the desired number.
  - d) Select **Send** or .
5. Do the following to place a SIP call on the phone.
  - a) Select **Conf**.
  - b) Enter the desired number.
  - c) Select **Send** or .
6. Repeat the step 5 to invite more parties (up to 4 parties).
7. Select **Conf**.

### Network Conference

If your system administrator has set a network conference feature on your phone, you can initiate a conference with two or more contacts.

- [Setting Up a Network Conference](#)
- [Inviting another Party into an Active Conference Call](#)
- [Holding/Resuming a Conference Call](#)
- [Ending a Conference Call](#)

#### Setting Up a Network Conference

You can set up a network conference with two or more contacts.

#### Procedure

1. Place a call to the first party.
2. Select **Options > Conference**.  
On the CP930W/DD phone, select **Conf**.  
*The active call is placed on hold.*
3. Dial the second party's number.
4. When the second party answers the call, select to add the second party to the conference.
5. Select to place a new call.  
*The conference call is placed on hold.*
6. Enter the number of the new party, and then press the OK key.
7. When the new party answers the call, select **Conf**. to add the new party to the conference.

8. Repeat steps 5 to 7 until you add all parties.



**Note:** The procedures for setting up a network conference call on specific servers may be different. Contact your system administrator for more information.

### Inviting another Party into an Active Conference Call

Any party in the conference call can invite other party into an active conference call.

#### Procedure

1. Select **New Call**.

On the CP930W/DD phone, select **Conf.** or **Hold > New Call**.

2. Enter the desired number and dial out.

3. When the new party answers the call, select **Options > Conference**.

On the CP930W/DD phone, select **Conf.**.

*The new party is joined the conference call.*

### Holding/Resuming a Conference Call

Any party in the conference call can place himself/herself on hold, but other parties can continue the conference call normally.

#### About this task



**Note:** The conference call will only be held when all parties in the conference call place themselves on hold.

#### Procedure

1. Select **Options > Hold**.

On the CP930W/DD phone, select **Hold**.

2. Select **Resume** to resume the held conference call.

### Ending a Conference Call

You can end the current conference call at any time.

#### Procedure

Press  or **End (End Call)**.

## Recording Using an SD Card

---

By default, you can record your calls into an SD card so that you can listen to them later.

For more information on how to attach an SD card, please refer to the Quick Start Guide for your phone on [Yealink Support](#).



**Note:** It is only applicable to CP930W.

- [Recording a Call](#)
- [Pausing/Resuming a Recording](#)
- [Stopping a Recording](#)
- [Managing the Recordings](#)
- [Viewing the Available Recording Time](#)

## Recording a Call

You can record the important parts during an active call.

### About this task

 **Note:** Before call recording, especially those involving PSTN, it is necessary to know about the rules and restrictions of call recording in the country where you are.

It is also very important to inform all the call parties that you are recording and ask for their consent before recording the conversation.

### Procedure

During a call, select **More > StartREC**.

*The phone screen displays a recording icon and recording duration.*

## Pausing/Resuming a Recording

When you do not want the current sensitive information to be recorded, you can pause the recording. After pausing, you can resume it at any time and the recording continues and will be saved in the same file.

### Procedure

1. Select **PauseREC** to pause a recording.

*The pause recording icon appears on the phone screen and the duration stops counting.*

2. Select **Re REC** to resume a recording.

 **Note:** If you hold the call during the recording, none of the parties will be recorded until you resume the call.

## Stopping a Recording

You can stop recording a call before the call ends. The recording also stops when the active call ends. The recording will be saved as a "\*.aac" file on the SD card automatically.

### Procedure

Do one of the following:

- Select **StopREC**.

The recording icon and recording duration disappears. The screen prompts a message that the call is recorded successfully.

- Select **End Call**.

The recording icon and recording duration disappears, and the phone returns to the idle screen. The screen prompts a message that the call is recorded successfully.

## Managing the Recordings

After stopping recording, you can manage the recordings on your phone. Make sure the is still inserted in the phone.

- [Listening to a Recording](#)
- [Pausing/Resuming a Playback](#)
- [Fast Forwarding/Rewinding a Playback](#)
- [Deleting a Recorded Call](#)

## Listening to a Recording

You can browse and play back the recordings on your phone.

### About this task



**Note:** You can also play back the recordings on a PC using an application capable of playing the "\*.aac" file.

### Procedure

1. Go to **Menu > Record > Browse Audio**.

*The phone screen shows all recorded files (filename and file size). The filename consists of the recording time & date, the other party's number/name (or the first person's number/name you called).*

2. Highlight the desired file and select **Play**.

*The length of the recording and a progress bar are displayed as the recording plays.*

## Pausing/Resuming a Playback

When you are playing a recording, you can pause it manually to take note.

### Procedure

1. Select **Pause** to pause the playback.
2. Select **Play** to restart the playback.

## Fast Forwarding/Rewinding a Playback

While a recording plays, you can fast forward or rewind the playback at any time.

### Procedure

Do the following:

- Select **▶▶** to skip forward the playback. Tap once to skip forward 1 minute.
- Select **◀◀** to rewind the playback. Tap once to rewind 1 minute.

## Deleting a Recorded Call

You can delete the recordings when you need additional space on your SD card or the recordings are useless.

### Procedure

1. Go to **Menu > Record > Browse Audio**.
2. Highlight the desired recording and select **Delete**.

*The phone prompts you whether to delete the audio.*

3. Confirm the action.

## Viewing the Available Recording Time

To avoid the recording failed due to timeout, you can view the storage space of the SD card, and check the available recording time before recording.

### Procedure

Go to **Menu > Record > Storage Space**.

## Advanced Call Features

---

By using the advanced features, your handset would perform more functions that make your work more efficiently.

If you require additional information or assistance with your new phone, contact your system administrator.

- [Call Park and Call Retrieve](#)
- [Shared Call Appearance \(SCA\)](#)
- [Voice Mail](#)

### Call Park and Call Retrieve

---

You can park a call, and then retrieve the call either from your phone or another phone. After parked, the call is placed on hold, you can continue the conversation after retrieving it.



**Note:** Call park is not available on all servers. Check with your system administrator to find out if it is available on your phone.

- [Parking or Retrieving a Call in the FAC Mode](#)
- [Parking or Retrieving a Call in the Transfer Mode](#)
- [Retrieving a Call with a Retrieve Key](#)

#### Parking or Retrieving a Call in the FAC Mode

You can park the call to the local extension or the desired extension through dialing the park code.

- [Parking a Call in the FAC Mode](#)
- [Retrieving a Parked Call in the FAC Mode](#)

##### Parking a Call in the FAC Mode

You can park a call in the FAC mode directly. When you park a call to the local extension or the desired extension, the call is held in the same network on your phone.

##### Before you begin

Your system administrator has set call park in the FAC mode.

##### Procedure

1. During a call, select **Options > Call Park**.

On the CP930W/DD phone, select **Call Park (Park)**.

*The phone will dial the call park code which is pre-configured.*

2. Do one of the following:

- If you want to park the call against the local extension, press the # key.
- If you want to park the call against the desired extension, enter the extension (for example, 4606) where you want to park the call and press the # key.

*If the call is parked successfully, you will hear a voice prompt that the call is parked.*

##### Retrieving a Parked Call in the FAC Mode

You can retrieve a parked call in the FAC mode from any phone within your network.

**Before you begin**

Your system administrator has set call park in the FAC mode. There is a call parked on the extension. Get the park retrieve code from your system administrator.

**Procedure**

1. Dial the park retrieve code.

On the CP930W/DD phone, you can also select **Retrieve** on the dialing screen.

2. Follow the voice prompt to retrieve:

- Press the # key on the phone where the call is parked.
- Enter the desired extension followed by # (for example, 4606#) on any phone.

**Parking or Retrieving a Call in the Transfer Mode**

You can park the call to the shared parking lot through a blind transfer.

For some servers, the system will return a specific retrieve park number (park retrieve code) after parking successfully.

- [Parking a Call in the Transfer Mode](#)
- [Retrieving a Parked Call in the Transfer Mode](#)

**Parking a Call in the Transfer Mode**

You can park a call in the transfer mode directly. When you park a call to the shared parking lot, the call is held on your phone.

**Before you begin**

Your system administrator has set call park in the Transfer mode.

**Procedure**

During a call, select **Options > Call Park**.

On the CP930W/DD phone, select **Call Park (Park)**.

*The call will be directly transferred to the shared parking lot.*

**Retrieving a Parked Call in the Transfer Mode**

You can retrieve a parked call in the transfer mode from any phone in the same network.

**Before you begin**

Your system administrator has set call park in the Transfer mode. There is a call parked on the shared parking lot.

**Procedure**

Dial the park retrieve code.

*The phone will retrieve the parked call from the shared parking lot.*



**Note:** When the W56H/W53H/DD phone is idle, you can use a **Retrieve** key to retrieve a parked call directly.

**Related tasks**

[Retrieving a Call with a Retrieve Key](#)

**Retrieving a Call with a Retrieve Key**

You can easily use a retrieve key to retrieve a parked call quickly.

**Before you begin**

Check with your system administrator if the FAC or Transfer mode is set on your phone, and if the call park feature has set for your phone. It is only applicable to W56H/W53H/DD phone.

**Procedure**

1. Go to **OK > Settings > Shortcut**.
2. Highlight the desired shortcut key and press **Change**.
3. Select **Retrieve**.

 **Note:** On the DD phone, go to **Menu > Features > DSS Keys** to configure a Retrieve Park key.

When there is a call parked on the extension or the shared parking lot, you can press the Retrieve key on the idle screen, and the handset will dial the configured park retrieve code.

## Shared Call Appearance (SCA)

---

Yealink phone supports using Shared Call Appearance (SCA) to share a line. So that this line can be registered on more than one phone at the same time. Your system administrator can set your phone to use the shared line.



- [W56H/W53H State Indicator of Shared Line](#)
- [Placing Calls on a Shared Line](#)
- [Answering Calls on a Shared Line](#)
- [Placing a Call on Public Hold](#)
- [Placing a Call on Private Hold](#)
- [Retrieving a Held Call on a Shared Line](#)
- [Barging in an Active Call on a Shared Line](#)
- [Pulling a Shared Call on a Shared Line](#)

### W56H/W53H State Indicator of Shared Line

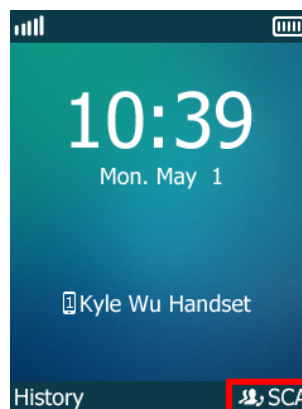
If your system administrator assigns the shared line to your handset, the SCA with an icon is displayed on the right soft key.



The following table shows the icon associated with the shared line:

Icons	Description
	The shared line is idle.
	The shared line is dialing, in conversation or placed on private hold.

Icons	Description
 (Flashing)	The shared line receives an incoming call or is placed on public hold.

## Placing Calls on a Shared Line

You can place one or multiple calls on a shared line.

### Related information

[Placing Calls](#)

## Answering Calls on a Shared Line

You can answer one or two calls on the shared line.

When an incoming call arrives on the shared line, all the registered phones will ring simultaneously, and the call can be answered on any one of the phones.

### Related information

[Answering Calls](#)

## Placing a Call on Public Hold

You can place a call on public hold that any shared line phone can retrieve the held call.

### Procedure

During a call, select **Options > Hold**.

On the CP930W/DD phone, select **Hold**.

## Placing a Call on Private Hold

You can place a call on private hold that only you on shared line can retrieve the held call.

### Procedure

During a call, select **Options > Private Hold**.

On the CP930W/DD phone, select **More > PriHold**.

*Then the call is held on your phone, and the other phones registered with shared line show the call is in the busy state. Other users on the shared line cannot resume your held call.*

## Retrieving a Held Call on a Shared Line

If you place a call on hold on a shared line, you can resume this call at any time. When the shared line key shows a call that is in a held state, you can resume the held call remotely from other user's phone.

### Before you begin

There is at least one call placed on public hold on the shared line.

### Procedure

1. On the W56H/W53H, select **SCA**, and then select the held call.
2. Select **Resume**.

## Barging in an Active Call on a Shared Line

In the SCA scenario, you can barge into an active call on the shared line. After you barge into a call, the call turns into a three-party conference.

### Before you begin

There is at least one active call on the shared line. Only one user can barge into an active call on the shared line at a time.

### About this task

It is not applicable to CP930W.

### Procedure

1. Select **SCA** and then select an active call.
2. Select **BargeIn (Barge In)** to interrupt the active call.

## Pulling a Shared Call on a Shared Line

In the SCA scenario, both you and other users can pull an existing call from another shared phone that is active or held.

### Before you begin

There is an active or held call on the shared line. Contact your system administrator for the call pull feature access code.

It is not applicable to CP930W.

### Procedure

1. Enter the call pull feature access code (for example, \*11).
2. Press the OK key to dial out.

## Voice Mail

---

Voice Mail feature allows you to leave voice mails for someone or listen to your voice mail messages on your IP phones. This feature is set up on the server-side and not all servers support this feature.

- [Setting the Voice Mail Code](#)
- [Leaving Voice Mails](#)
- [Listening to Voice Mails](#)

### Setting the Voice Mail Code

If you want to connect to the message center, you need to set the voice mail code on your phone.

#### Procedure

1. Go to **OK > Voice Mail > Set Voice Mail**.  
On the CP930W, go to **Menu > Message > Set Voice Mail Code**.  
On the DD phone, go to **Menu > Message > Voice Mail > Set Voice Mail Code**.
2. On the W56H/W53H/CP930W, select **Enabled** from the **Status** field.
3. Enter the voice mail code.
4. Confirm the action.

## Leaving Voice Mails

You can leave a voice mail to someone who is busy or inconvenient to answer the call.

### Procedure

1. Follow the voice prompts to leave a voice mail.
2. Hang up to complete the voice mail.

## Listening to Voice Mails

You can listen to your voice mails on the handset directly.

### Before you begin

You need to set the voice mail code in advance.

### Procedure

1. Go to **OK > Voice Mail > Play Message** or press the Message key.  
 On the CP930W, go to **Menu > Message > Play Message**.  
 On the DD phone, go to **Menu > Message > Voice Mail > View Voice Mail**.
2. Follow the voice prompt from the system server to listen to your voice mails.

# Directory

---

The phone provides several types of phone directories, which can be customized by your system administrator.

- [Local Directory](#)
- [Shared Directory](#)
- [Blocklist](#)
- [Remote Phone Book](#)

## Local Directory

---

You can store up to 100 contacts in the handset's Local Directory, as well as add, edit and delete a contact.

- [Adding Contacts](#)
- [Viewing Contacts](#)
- [Editing Contacts](#)
- [Deleting Contacts](#)
- [Searching for Contacts](#)

## Adding Contacts

When you add a contact to your Local Directory, you can choose how much information you want to enter for your contact. You are required to enter a contact name at least for each new contact.

### Procedure

1. Go to **OK > Directory** or **OK > Directory > Local Directory**.  
 On the CP930W/DD phone, select **Directory** or go to **Directory > Local Directory**.

## 2. Select **Options > New Contact**.

On the CP930W/DD phone, select **Add**.

3. Enter the contact's information.
4. Confirm the action.

## Viewing Contacts

You can view the local contacts from the Local Directory on your phone.

### Procedure

1. Go to **OK > Directory** or **OK > Directory > Local Directory**.

On the CP930W/DD phone, select **Directory** or go to **Directory > Local Directory**.

2. Use the navigation keys to look through the contacts.

*The contact names are displayed in alphabetical order.*

## Editing Contacts

You can modify or add more information to your contacts.

### Procedure

1. Go to **OK > Directory** or **OK > Directory > Local Directory**.

On the CP930W/DD phone, select **Directory** or go to **Directory > Local Directory**.

2. Highlight the desired contact and select **Options > Edit**.

On the CP930W/DD phone, select **Options (Option) > Detail**.

3. Edit the contact information.
4. Confirm the action.

## Deleting Contacts

You can delete one or all contacts from the Local Directory.

- [Deleting a Contact](#)
- [Deleting All Contacts](#)

### Deleting a Contact

You can delete any contact from the Local Directory.

### Procedure

1. Go to **OK > Directory** or **OK > Directory > Local Directory**.

On the CP930W/DD phone, select **Directory** or go to **Directory > Local Directory**.

2. Highlight the desired contact and select **Options (Option) > Delete**.

*The phone prompts you whether to delete this contact.*

3. Confirm the action.

### Deleting All Contacts

You can delete all contacts from the Local Directory.

**Procedure**

1. Go to **OK > Directory** or **OK > Directory > Local Directory**.

On the CP930W/DD phone, select **Directory** or go to **Directory > Local Directory**.

2. Highlight the desired contact and select **Options (Option) > Delete All**.

*The phone prompts you whether to delete all contacts.*

3. Confirm the action.

**Searching for Contacts**

In the Local Directory, you can enter search criteria to find your desired contact quickly.

**Procedure**

1. Go to **OK > Directory** or **OK > Directory > Local Directory**.

On the CP930W/DD phone, select **Directory** or go to **Directory > Local Directory**.

2. Enter your search criteria in the search field.

On the CP930W, enter your search criteria directly by tapping the keypad.

**Shared Directory**

---

All handsets that are registered on the same DM can share the contacts with each other. You can store up to contacts in your phone's Shared Directory.

It is not applicable to DD phones.



**Note:** Check with your system administrator to find out if this feature is available on your phone.

- [Adding Shared Contacts](#)
- [Editing Shared Contacts](#)
- [Deleting a Shared Contact](#)
- [Deleting All Shared Contacts](#)
- [Searching for Shared Directory Contacts](#)
- [Saving a Shared Contact to the Local Directory](#)

**Adding Shared Contacts**

When you add a contact to your Shared Directory, you can choose how much information you want to enter for your contact. You are required to enter a contact name at least for each new contact.

**Procedure**

1. Go to **OK > Directory > Shared Directory**.

On the CP930W, go to **Directory > Shared Directory**.

2. Select **Options > New Contact**.

On the CP930W, select **Add**.

3. Enter the contact's information.
4. Confirm the action.

**Editing Shared Contacts**

You can modify or add more information to your contacts.

**Procedure**

1. Go to **OK > Directory > Shared Directory**.  
On the CP930W, go to **Directory > Shared Directory**.
2. Highlight the desired contact and select **Options > Edit**.  
On the CP930W, select **Options > Detail**.
3. Edit the contact information.
4. Confirm the action.

**Deleting a Shared Contact**

You can delete any contact from the Shared Directory.

**Procedure**

1. Go to **OK > Directory > Shared Directory**.  
On the CP930W, go to **Directory > Shared Directory**.
2. Highlight a contact and select **Options > Delete**.  
*The phone prompts you whether to delete this contact.*
3. Confirm the action.

**Deleting All Shared Contacts**

You can delete all contacts from the Directory.

**Procedure**

1. Go to **OK > Directory > Shared Directory**.  
On the CP930W, go to **Directory > Shared Directory**.
2. Highlight a contact and select **Options > Delete All**.  
*The phone prompts you whether to delete all contacts.*
3. Confirm the action.

**Searching for Shared Directory Contacts**

In the Shared Directory, you can enter search criteria to find your desired contact quickly.

**Procedure**

1. Go to **OK > Directory > Shared Directory**.  
On the CP930W, go to **Directory > Shared Directory**.
2. Enter your search criteria in the search field.  
On the CP930W, enter your search criteria directly by tapping the keypad.

**Saving a Shared Contact to the Local Directory**

You can move a shared contact to the Local Directory. The shared contacts added to the Local Directory will not disappear, even after your system administrator disables the Shared Directory feature.

**Procedure**

1. Go to **OK > Directory > Shared Directory**.

On the CP930W, go to **Directory > Shared Directory**.

2. Highlight a contact and select **Options > Add To Local > New Entry**.
3. Edit the contact information.
4. Confirm the action.



**Tip:** You can select **Add To Local > Update Existing** to update the existing contact information.

## Blocklist

---

Incoming calls from the Blocklist are rejected automatically. You can store up to 30 contacts in the blocklist to block unwanted callers.

- [Adding a Blocklist Contact](#)
- [Viewing Blocklist Contacts](#)
- [Editing a Blocklist Contact](#)
- [Deleting Blocklist Contacts](#)

### Adding a Blocklist Contact

You can add a blocklist contact on the phone to prevent someone from calling you.

**Procedure**

1. Go to **OK > Settings > Telephony > Blocklist**.

On the DD phone, go to **Menu > Directory > Blocklist**.

On the CP930W, go to **Menu > Settings > Basic Settings > Blocklist**.

2. Select **New Entry** or **Options > New Entry**.

On the CP930W/DD phone, select **Add**.

3. Enter the contact's information.
4. Confirm the action.

### Viewing Blocklist Contacts

You can view the blocklist contacts from the blocklist on your phone.

**Procedure**

1. Go to **OK > Settings > Telephony > Blocklist**.

On the DD phone, go to **Menu > Directory > Blocklist**.

On the CP930W, go to **Menu > Settings > Basic Settings > Blocklist**.

2. Use the navigation keys to look through the blocklist contacts.

### Editing a Blocklist Contact

You can update your blocklist contacts' information.

**Procedure**

1. Go to **OK > Settings > Telephony > Blocklist**.  
 On the DD phone, go to **Menu > Directory > Blocklist**.  
 On the CP930W, go to **Menu > Settings > Basic Settings > Blocklist**.
2. Highlight the desired blocklist contact and select **Options > Edit**.  
 On the CP930W/DD phone, select **Options (Option) > Detail**.
3. Edit the contact information.
4. Confirm the action.

**Deleting Blocklist Contacts**

You can delete one or all blocklist contacts. If a contact is removed from the blocklist, you can answer the call from the contact normally.

- [Deleting a Blocklist Contact](#)
- [Deleting All Blocklist Contacts](#)

**Deleting a Blocklist Contact**

If you want to answer a call from a specific contact, you need to remove it from the blocklist.

**Procedure**

1. Go to **OK > Settings > Telephony > Blocklist**.  
 On the DD phone, go to **Menu > Directory > Blocklist**.  
 On the CP930W, go to **Menu > Settings > Basic Settings > Blocklist**.
2. Highlight the desired blocklist contact and select **Options > Delete**.
3. Confirm the action.

**Deleting All Blocklist Contacts**

You can delete all contacts from the Blocklist when you are ready to answer calls from them again.

**Procedure**

1. Go to **OK > Settings > Telephony > Blocklist**.  
 On the DD phone, go to **Menu > Directory > Blocklist**.  
 On the CP930W, go to **Menu > Settings > Basic Settings > Blocklist**.
2. Highlight the desired blocklist contact and select **Options (Option) > Delete All**.  
*The phone prompts you whether to delete all contacts.*
3. Confirm the action.

**Remote Phone Book**

---

If the Remote Phone Book feature has been enabled by your system administrator, you can access your corporate directory directly from your phone.

- [Searching for Remote Phone Book Contacts](#)
- [Viewing Remote Phone Book Contacts](#)
- [Saving a Remote Phone Book Contact to the Local Directory](#)

## Searching for Remote Phone Book Contacts

In the Remote Phone Book, you can enter search criteria to find your desired contact quickly.

### Procedure

1. Go to **OK > Directory**.

On the CP930W/DD phone, go to **Directory > Remote Phone Book**.

2. Select the desired remote phone book.
3. Enter your search criteria in the search field.

On the CP930W, enter your search criteria directly by tapping the keypad.

## Viewing Remote Phone Book Contacts

You can view the contact list of the Remote Phone Book on your phone.

### Procedure

1. Go to **OK > Directory**.

On the CP930W/DD phone, go to **Directory > Remote Phone Book**.

2. Select the desired remote phone book.
3. Use the navigation keys to look through the contacts.

## Saving a Remote Phone Book Contact to the Local Directory

You can save any remote phone book contact to the Local Directory, to conveniently call this contact when you cannot access the Remote Phone Book.

### Procedure

1. Go to **OK > Directory**.

On the CP930W/DD phone, go to **Directory > Remote Phone Book**.

2. Select the desired remote phone book.
3. Highlight the desired contact and select **Options > Add To Local > New Entry**.

On the DD phone, select **Option > Add to Contact**.

4. Edit the contact information.
5. Confirm the action.



**Tip:** You can select **Add To Local > Update Existing** to update the existing contact information.

## Call History

---

The call history list includes Missed Calls, Placed Calls and Received Calls, and each list holds 100 entries.

- [Call History Icons](#)
- [Viewing History Records](#)
- [Saving a History Record to Local Directory](#)
- [Saving a History Record to Blocklist](#)



- [Deleting History Records](#)

## Call History Icons



---

The call history icon in the Call History indicates the corresponding call history types.

### W56H/W53H:

Icon	Description
	Received Calls
	Missed Calls
	Placed Calls

### CP930W/DD phone:

Icon	Description
	Received Calls
	Missed Calls
	Placed Calls

## Viewing History Records

---

The history record saves the call information such as the caller's name and number, local line and call duration.

### Procedure

1. Press **History**.
2. Select the desired list.
3. Highlight the desired entry and select **Options(Option) > Detail**.

## Saving a History Record to Local Directory

---

To identify someone's call the next time, you can save a history record to the Local Directory.

### Procedure

1. Press **History**.
2. Select the desired list.
3. Highlight the desired entry and select **Options > Add To Local > New Entry**.  
On the DD phone, select **Option > Add to Contacts**.
4. Edit the contact information.

5. Confirm the action.



**Tip:** You can select **Add To Local > Update Existing** to update the existing contact information.

## Saving a History Record to Blocklist

---

You can prevent someone from calling you again by saving a history record to the blocklist.

It is not applicable to DD phones.

### Procedure

1. Press **History**.
2. Select the desired list.
3. Highlight the desired entry and select **Options > Add To Blocklist**.

*The phone prompts you whether to add it or not.*

*Select the phone number you want to block and tap **Done**.*

4. Confirm the action.

## Deleting History Records

---

You can delete one or all call records from the call history list.

- [Deleting a Call Record](#)
- [Deleting All Call Records](#)

### Deleting a Call Record

You can delete any call record from the call history list.

#### Procedure

1. Press **History**.
2. Select the desired list.
3. Highlight the desired entry and select **Options > Delete**.

On the DD phone, highlight the desired entry and select **Delete**.

*The selected entry is deleted successfully.*

### Deleting All Call Records

You can delete all call records from the call history list.

#### Procedure

1. Press **History**.
2. Select the desired list.
3. Select **Options (Option) > Delete All**.

*The phone prompts you whether to delete all records.*

4. Confirm the action.

# Customizing Your Phone

---

You can make your phone more personalized by customizing various settings.

- [Turning Handset On](#)
- [Turning Handset Off](#)
- [Changing the Wallpaper](#)
- [Setting the Screen Saver](#)
- [Changing the W56H/W53H/CP930W Brightness](#)
- [Changing the DD Phone Brightness](#)
- [Setting the Keypad Light](#)
- [Changing the Language](#)
- [Time & Date](#)
- [Customizing the Soft Keys](#)
- [Shortcuts](#)
- [Locking Your W56H/W53H](#)
- [Locking Your DD Phone](#)
- [Silent Mode](#)

## Turning Handset On

---

The W56H/W53H will be turned on automatically when the battery is inserted into the handset. The CP930W will be turned on automatically when the phone is placed in the charging cradle. You can also turn the handset on manually.

### About this task

It is only applicable to W56H/W53H/CP930W.

### Procedure

Do one of the following:

- Press the On-hook key. The handset screen lights up.  
On the CP930W, long press the On-hook key. The mute touch key glows red and then the handset screen lights up.
- Place the handset to the charging cradle.

## Turning Handset Off

---

The handset will be turned off automatically when the battery runs out. You can also turn the handset off manually.

### About this task

It is only applicable to W56H/W53H/CP930W

.

### Procedure

Long press the On-hook key when the handset is idle.

On the CP930W, a message prompts whether to power off the device.



**Note:** You cannot turn the CP930W off when the phone is charging.

## Changing the Wallpaper

---

You can change the wallpaper that is displayed on the idle screen.

### About this task

It is only applicable to W56H/W53H.

### Procedure

1. Go to **OK > Settings > Display > Wallpaper**.  
On the DD phone, go to **Menu > Basic Settings > Display > Wallpaper**.
2. Press the navigation keys to select the desired image.
3. Confirm the action.

## Setting the Screen Saver

---

The screen saver is designed to protect your phone screen. When the screen saver is enabled, an analog clock will be activated and appear on the phone screen if the handset is idle for approximately 10 seconds.

### About this task

It is only applicable to W56H/W53H.

### Procedure

1. Go to **OK > Settings > Display > Screen Saver**.
2. Press **Change** to select the **Screen Saver** check box (the default status is checked).

## Changing the W56H/W53H/CP930W Brightness

---

For W56H/W53H, the handset backlight in charger or out of charger can be configured independently.

When in charger/out of charger is enabled, the backlight will be turned off after the handset is idle for about 30 minutes when the handset is or is not in the charging cradle. When an incoming call arrives, a key is pressed or the handset status changes, the backlight is automatically turned on.

For CP930W, the backlight automatically turns off, when the phone is charging and inactive for a specified time.



**Note:** When the CP930W is not in charging, its backlight will be turned off after the phone is inactive for about 30 seconds.

### Procedure

1. Go to **OK > Settings > Display > Display Backlight**.  
On the CP930W, go to **Menu > Settings > Basic Settings > Display > Display Backlight**.
2. Select the desired value from the **Active Level** field.

3. Select the desired value from the **In Charger** or **Out Of Charger** field.  
On the CP930W, select the desired value from the **Time in Charger** field.
4. Confirm the action.

## Changing the DD Phone Brightness

---

You can configure the backlight to adjust the brightness of the phone screen. Backlight status on the phone screen can be configured from the following options:

- **Always On:** Backlight is on permanently.
- **Always Off:** Backlight is off permanently.
- **15s, 30s, 1min, 2min, 5min, 10min, or 30min:** Backlight is turned off when the phone is inactive after the designated time (in seconds).

### Procedure

1. Go to **Menu > Settings > Basic Settings > Display > Backlight**.
2. Select the desired time from the **Backlight Time** field.
3. Confirm the action.

## Setting the Keypad Light

---

You can enable the keypad light to illuminate the keypad keys when any key is pressed.

### About this task

It is only applicable to W56H/W53H.

### Procedure

1. Go to **OK > Settings > Display > Keypad LED**.
2. Press **Change** to select the **Keypad LED** check box (the default status is checked).

## Changing the Language

---

Your phone supports several languages that you can choose to use on the phone.

### Before you begin

Contact your system administrator to find out exactly which languages are supported on your phone.

### Procedure

1. Go to **OK > Settings > Language**.  
On the CP930W/DD phone, go to **Menu > Settings > Basic Settings > Language**.
2. Select the desired language.

*The phone prompts you whether to change the language.*

3. Confirm the action.

*The phone language is changed to the selected one.*

## Time & Date

---

You can set the time and date manually. The time and date formats are also variable.

- [Setting the Time and Date Manually](#)
- [Changing the Time and Date Format](#)

### Setting the Time and Date Manually

If your phone cannot obtain the time and date automatically, you can set it manually.

#### Procedure

1. Go to **OK > Settings > Date & Time**.

On the CP930W, go to **Menu > Settings > Basic Settings > Time & Date**.

On the DD phone, go to **Menu > Settings > Basic Settings > Time & Date > Manual Settings**.

2. Edit the date and time.
3. Confirm the action.

*The time and date set on the handset will be changed accordingly.*

### Changing the Time and Date Format

You can set the phone to display the time in 12-hour or 24-hour format. You can also change the date format, including the options to display the day (D), month (M), and year (Y).

#### Procedure

1. Go to **OK > Settings > Display > Time Format** or **Date Format**.

On the DD phone, go to **Menu > Settings > Basic Settings > Time & Date > Time & Date Format**.

On the CP930W, go to **Menu > Settings > Basic Settings > Display > Time Format** or **Date Format**.

2. Select the desired time format or date format.
3. Confirm the action.

## Customizing the Soft Keys

---

You can customize the function of the soft keys displayed on the bottom of the idle screen. The soft keys are typically used to access frequently used functions, and to create menu shortcuts to access frequently used phone settings.

#### About this task

It is only applicable to the CP930W/DD phone.

#### Procedure

1. Go to **Menu > Settings > Advanced Settings (default PIN: 0000) > Softkey Label**.
2. Select the desired soft key.
3. Select the desired key type from the **Type** field.

#### 4. Confirm the action.



**Note:** If you replace another key of the **Menu** soft key on CP930W, you can access the phone settings by pressing the **OK** key. For DD phone, we recommend that you keep a **Menu** soft key; otherwise, you may not access the phone settings.

## Shortcuts

---

Shortcuts allow you to quickly access the feature without scrolling through the menu when the phone is idle. You can configure six shortcuts on the phone in total.





It is only applicable to W56H/W53H.

- [Supported Shortcuts](#)
- [Customizing the Shortcuts](#)

## Supported Shortcuts

By default, the handset provides a certain access feature for a certain shortcut, you can change it to make your phone more personalized.

The following table lists the default access feature of the desired shortcut, and the available access features for all shortcuts:

Shortcut	Default Access Feature	Available Access Features
Left Softkey	History	History
Right Softkey	Line Status	Missed
	Intercom (not available in the multi-cell system)	Received Redial
	Directory	Speed Dial
	Volume-	Menu
	Volume+	Line Status Default Line Call Forward Do Not Disturb Directory Local Directory Remote Directory LDAP Volume- Volume+ Paging Retrieve Shared Directory Status XML Browser XML Dir

## Customizing the Shortcuts

You can customize the function of the shortcuts to make your handset more personalized.

### Procedure

1. Go to **OK > Settings > Shortcut**.
2. Select the desired shortcut and select **Change**.

*The feature currently assigned to the selected key is highlighted and followed by a left arrow.*

3. Select the desired feature.

### Related information

[Supported Shortcuts](#)

## Locking Your W56H/W53H

To prevent accidental use of the handset, the keypad can be locked manually. When the keypad is locked, incoming calls will still ring on your phone, but only the emergency numbers can be dialed out.

- [Locking Handset Keypad](#)
- [Unlocking Your Handset](#)

## Locking Handset Keypad

When you temporarily do not use your handset, you can lock it manually.

### Procedure

Long press the # key when the handset is idle until the phone prompts you the handset is locked.

*The lock icon appears in the status bar.*

## Unlocking Your Handset

When you need to use the locked handset, you can unlock it manually.

### Procedure

Long press the # key when the locked handset is idle until the phone prompts you the handset is unlocked.

*The lock icon disappears from the status bar.*

## Locking Your DD Phone

---

Phone lock helps you protect your phone from unauthorized use.

- [Setting the Phone Lock](#)
- [Locking Your Phone Manually](#)
- [Unlocking Your Phone](#)
- [Changing Your Phone Unlock PIN](#)

## Setting the Phone Lock

You can manually lock the phone or wait a specified time to automatically lock the phone.

### About this task

What unauthorized users can do depends on the settings of the phone lock type.

The phone supports the following phone lock types:

- **Menu key:** it prevents unauthorized users from accessing the menu, changing the personal settings for your phone.
- **Function key:** it only allows users to use the keypad for placing a call, answering or rejecting an incoming call and ending a call, and it prevents unauthorized users from other operations.
- **All keys:** it only allows users to use the keypad for dialing an emergency number or authorized numbers that set up by your system administrator, answering or rejecting an incoming call and ending a call, and it prevents unauthorized users from other operations. The phones only support All Keys type of phone lock.



**Note:** The Volume key always available when you lock the phone.

### Procedure

1. Go to **Menu > Settings > Basic Settings > Phone Lock**.
2. Enter the desired PIN (default PIN: 123) in the **Unlock PIN** field and confirm the action.
3. Select **Enabled** from the **Lock Enable** field.

4. Select the desired type from the **Lock type** field.
5. Enter the desired interval (0 - 3600 seconds) in the **Lock Time Out** field.  
If the value is set to 0, the phone will not be automatically locked.
6. Confirm the action.

## Locking Your Phone Manually

You can lock the phone manually before the phone is automatically locked.

### Before you begin

Make sure that the phone lock is set.

### Procedure

Long press # key when the phone is idle.

*The lock icon appears on the phone screen.*

## Unlocking Your Phone

You can use an unlock PIN to unlock the phone.

### About this task

If you forget the unlock PIN, you can enter the administrator password to unlock your phone, and then automatically access the PIN change screen.

### Procedure

1. Press any locked key, the phone prompts you to enter an unlock PIN.
2. Enter the desired PIN (default: 123) in the **Unlock PIN** field.
3. Confirm the action.

*The lock icon disappears from the phone screen.*

## Changing Your Phone Unlock PIN

The default unlock PIN is "123". For security reasons, you should change the default unlock PIN as soon as possible.

### Procedure

1. Go to **Menu > Settings > Basic Settings > Change PIN**.
2. Enter your old and new unlock PIN respectively.  
The unlock PIN length must be within 15 digits.
3. Confirm the action.

## Silent Mode

---

You can enable the silent mode if you do not want to be disturbed. The handset will not ring when receiving an incoming call, but it will still display the incoming call information.

It is only applicable to W56H/W53H.

- [Switching on Silent Mode](#)

- [Switching off Silent Mode](#)

## Switching on Silent Mode

You can silence an incoming call by switching on silence mode to stop your phone from ringing.

### Procedure

Long press the \* key until the phone prompts “All Ring Tones Off”.

The silent icon  appears in the status bar.

## Switching off Silent Mode

If you want to resume the incoming ring, you can switch off silent mode.

### Procedure

Long press the \* key until the phone prompts “All Ring Tones On”.

The silent icon  disappears from the status bar.

# Audio Settings

---

You can change the basic audio settings on your phone.

- [Adjusting the Volume](#)
- [Setting the Ring Tone](#)
- [Silent Charging](#)
- [Setting the Advisory Tone](#)
- [Setting the Vibrator](#)
- [Setting the Key Tone](#)
- [Disabling the Noise Cancellation](#)

## Adjusting the Volume

---

You can adjust the volume of the ringer, media, and audio during a call.

### Procedure

Do one of the following:

- Press the left or right navigation key when the handset is idle.
- Go to **OK > Settings > Audio > Ring Tones > Volume** and press the left or right navigation key.

On the CP930W/CP935W, press the Volume touch key.

On the DD phone, press the Volume key .

## Setting the Ring Tone

---

Ring tones are used to indicate the incoming calls.

- [Setting the Ring Tone for the External Calls](#)

## Setting the Ring Tone for the External Calls

You can select a unique ring tone for the external calls so that you can identify callers when the phone rings.

### Procedure

1. Go to **OK > Settings > Audio > Ring Tones > Melodies**.

On the CP930W, go to **Menu > Settings > Basic Settings > Sound > Ring Tones**.

On the DD phone, go to **Menu > Settings > Basic Settings > Sound > Ring Tones > Common**.

2. Select the desired ring tone.

*The ring tone is played automatically.*

3. Confirm the action.

## Silent Charging

---

With the silent mode, you can silence your phones when charging but still get messages. When you finish charging, the phone will be unmuted automatically. It is not applicable to DD phones/CP935W.

### Procedure

1. Go to **OK > Settings > Audio**.

On the CP930W, go to **Menu > Settings > Basic Settings > Sound**.

2. Press **Change** to select the **Silent Charging** check box.

## Setting the Advisory Tone

---

Advisory tones are the acoustic signals of your handset, which inform you of different actions and states. It is not applicable to DD phones.

### About this task

You can configure the following advisory tones independently:

- **Keypad Tone:** plays when you press any key on the keypad.
- **Touch Tone:** plays when you tap the keys (except the touch keypad). It is only applicable to CP930W.
- **Confirmation:** plays when a setting is changed or the handset is placed in the charger cradle.
- **Low Battery:** plays when the battery's remaining capacity is low and the handset needs charging.



**Note:** If the silent mode is activated, the advisory tones will not play, but you can still see the alert of low battery on the phone screen.

### Procedure

1. Go to **OK > Settings > Audio > Advisory Tones**.

On the CP930W, go to **Menu > Settings > Basic Settings > Sound > Advisory Tones**.

2. Select the desired value from the **Keypad Tone** field.
3. On the CP930W, select the desired value from the **Touch Tone** field.
4. Select the desired value from the **Confirmation** field.
5. Select the desired value from the **Low Battery** field.

6. Confirm the action.

## Setting the Vibrator

---

By default, the phone simultaneously vibrates and rings when receiving an incoming call.

### About this task

It is only applicable to W57R/W59R/W78H.

The following vibration settings are available for the incoming call:

- **Vibrate and Ring:** The handset will simultaneously ring and vibrate.
- **Vibrate:** The handset will vibrate only.
- **Vibrate then Ring:** The handset will vibrate four times and then start ringing.
- **Off**



**Note:** If the silent mode is activated, the handset will not vibrate and ring.

### Procedure

1. Go to **OK > Settings > Audio > Vibrator**.
2. Select the desired method.

## Setting the Key Tone

---

If you enable the key tone, the phone will produce a sound when you press the keypad. It is only applicable to DD phone.

### Procedure

1. Go to **Menu > Settings > Basic Settings > Sound > Key Tone**.
2. Select the desired value from the **Key Tone** field.
3. Confirm the action.

## Disabling the Noise Cancellation

---

Noise cancellation helps improve intelligibility of speech in noisy environments. You can disable it.

### About this task

It is only applicable to W57R/W59R/W73H/W78H.

### Procedure

1. Go to **OK > Settings > Audio > Noise Cancellation**.
2. Disable the noise cancellation.
3. Confirm the action.

## W59R/W78H Bluetooth

---

You can use a Bluetooth headset with the W59R/W78H handset. By default, the Bluetooth feature is disabled. To be able to use Bluetooth, it must be enabled.

- [Enabling/Disabling the Bluetooth](#)
- [Searching and Pairing with a Bluetooth Headset](#)
- [Managing Paired Headsets](#)
- [Editing Device Name of Your Handset](#)

### Enabling/Disabling the Bluetooth

---

#### Procedure

1. Go to **OK > Settings > Bluetooth**.
2. Select **Enabled/Disabled** from the **Bluetooth** field.
3. Confirm the action.

### Searching and Pairing with a Bluetooth Headset

---

#### Before you begin

Make sure that the Bluetooth mode is activated.

#### Procedure

1. Go to **OK > Settings > Bluetooth**.
2. Select **Scan Devices**.  
*The search result list displays up to 20 Bluetooth devices.*
3. Put the Bluetooth headset into pairing mode.  
*For more information, please refer to the headset's user guide.*
4. If the W59R/W78H has detected more than one headset, select yours from the list and press **Pair**.  
When pairing is successful, you will see the message "Connect Success".

### Managing Paired Headsets

---

#### Procedure

1. Go to **OK > Settings > Bluetooth**.
2. Select **Paired Devices**.
3. Select the device and press **Discon.** or **Connect** to unpair or connect to the device.
4. Select **Options** and you can do the following:
  - Select **Delete** to delete the selected handset from the list.
  - Select **Delete All** to delete all handsets from the list.
  - Select **Info** to view the handset name and Bluetooth MAC or change the name of the handset.

## Editing Device Name of Your Handset

---

You can edit the name of the W59R/W78H, so it can be easily recognized.

### Before you begin

Make sure that Bluetooth is enabled.

### Procedure

1. Go to **OK > Settings > Bluetooth > My Devices**.

*The phone screen displays the device name.*

2. Enter the desired name in the **Device Name** field.
3. Confirm the action.

## Connecting a Mobile Phone via Bluetooth

---

Bluetooth enables low-bandwidth wireless connections within a range of 10 meters (32 feet). The best performance is in the range of 1 to 2 meters (3 to 6 feet).

You can pair and connect the Bluetooth-enabled mobile phone with your phone. After connection, you can do the following:

- Make and receive mobile calls on the phone
- Use the phone as a Bluetooth speaker for your mobile phone to play music.
- Merge the calls on your phones, the PC and connected mobile phone into a hybrid UC conference

It is only applicable to CP930W.

- [Activating the Bluetooth Mode](#)
- [Pairing and Connecting the Bluetooth-enabled Mobile Phone](#)
- [Enabling the Phone Audio](#)
- [Enabling the Phone Media](#)
- [Handling a Mobile Phone Call on the Phone](#)
- [Editing Device Name of Your Phone](#)
- [Making the Phone Discoverable](#)
- [Deleting the Paired Bluetooth Device](#)
- [Disconnecting the Bluetooth Device](#)
- [Deactivating the Bluetooth Mode](#)

### Related tasks

[Creating a Hybrid UC Meeting with Mobile Phone and PC](#)

## Activating the Bluetooth Mode

---

You should activate the Bluetooth mode first when you need to connect the Bluetooth device to your phone.

### Procedure

1. Tap  or go to **Menu > Settings > Basic Settings > Bluetooth**.
2. Select **On** from the **Bluetooth** field.

3. Confirm the action.

## Pairing and Connecting the Bluetooth-enabled Mobile Phone

---

The phone cannot scan the Bluetooth devices, so you have to pair and connect the phone from your Bluetooth-enabled mobile phone.

### Before you begin

Make sure you have activated the Bluetooth mode and made the phone discoverable.

### Procedure

1. Scan and pair the phone from the Bluetooth-enabled mobile phone (the default device name of your phone is "Yealink-CP930W"/"").
2. Select **OK** when the phone prompts the connection passkey.

### Related tasks

[Activating the Bluetooth Mode](#)

[Making the Phone Discoverable](#)

## Enabling the Phone Audio

---

When you enable the phone audio, the phone can act as a speaker and microphone for your connected mobile phone.

The call is made through your mobile phone, but the audio is present on the phone and the call is also controlled by the phone.

### Procedure

1. Select  > **Paired Bluetooth Device** or go to **Menu** > **Settings** > **Basic Settings** > **Bluetooth** > **Paired Bluetooth Device**.
2. Select **Options** > **Detail** > **Channel Control**.
3. Select **Enabled** from the **Phone Audio** field.
4. Confirm the action.

## Enabling the Phone Media

---

You can enable the media audio feature to use the phone as a Bluetooth speaker for your mobile phone/PC to play music.

### Procedure

1. Select  > **Paired Bluetooth Device** or go to **Menu** > **Settings** > **Basic Settings** > **Bluetooth** > **Paired Bluetooth Device**.
2. Select **Options** > **Detail** > **Channel Control**.
3. Select **Enabled** from the **Media Audio** field.

#### 4. Confirm the action.



**Note:** When your device first connects to CP930W, you will be asked whether to open the media channel after connecting successfully.

## Handling a Mobile Phone Call on the Phone

---

You can handle a mobile phone call on your phone, the phone acts as a speaker and microphone for your mobile phone.

### Before you begin

1. Make sure that the Bluetooth-enabled mobile phone is paired and connected to your phone.
2. You have enabled the phone audio.

### Procedure

Do the following on the phone:

- Place a call. Tap , and then tap **Switch** to switch to the Bluetooth channel. Place a call or multiple calls to the mobile contact.
- Answer a call. An incoming call to your mobile phone is also shown on the phone, you can answer the call on the phone.
- During the call, you can hold/resume, mute/unmute or end the call on the phone.

## Editing Device Name of Your Phone

---

You can edit the device name of your phone for easily recognizable.

### Before you begin

Make sure that the Bluetooth mode is activated.

### Procedure

1. Select  > **Edit My Device Information** or go to **Menu** > **Settings** > **Basic Settings** > **Bluetooth** > **Edit My Device Information**.

*The phone screen displays the device name.*

2. Enter the desired name in the **Device Name** field.
3. Confirm the action.

### Related tasks

[Activating the Bluetooth Mode](#)

## Making the Phone Discoverable

---

If you make your phone discoverable to other Bluetooth devices, other Bluetooth devices can scan and find your IP phone.

### Before you begin

Make sure that the Bluetooth mode is activated.

**Procedure**

1. Select  > **Edit My Device Information** or go to **Menu > Settings > Basic Settings > Bluetooth > Edit My Device Information**.
2. Select **On** from the **Open Discover** field.
3. Confirm the action.

**Related tasks**

[Activating the Bluetooth Mode](#)

## Deleting the Paired Bluetooth Device

---

You can delete the Bluetooth device paired from your phone, the next time you activate the Bluetooth mode, the phone will not automatically connect to this device.

**Procedure**

1. Select  > **Paired Bluetooth Device** or go to **Menu > Settings > Basic Settings > Bluetooth > Paired Bluetooth Device**.
2. Select **Options > Delete**.

*The phone prompts you whether to delete the device.*

3. Confirm the action.

## Disconnecting the Bluetooth Device

---

You can disconnect your Bluetooth device from your phone. When you disconnect a Bluetooth device, it remains paired and you can reconnect it to your phone.

**Procedure**

1. Select  > **Paired Bluetooth Device** or go to **Menu > Settings > Basic Settings > Bluetooth > Paired Bluetooth Device**.
2. Highlight the connected Bluetooth device and select **Disconnect**.

## Deactivating the Bluetooth Mode

---

After you deactivate the Bluetooth mode, the Bluetooth device will disconnect from your phone, but it remains paired and you can reconnect it to your phone.

**Procedure**

1. Tap  or go to **Menu > Settings > Basic Settings > Bluetooth**.
2. Select **Off** from the **Bluetooth** field.
3. Confirm the action.

## Using Your CP930W with PC

---

When connected to the PC, the phone acts as a speaker and microphone during calls.

From your phone, you can do the following:

- Manage the audio from calls or media played on your PC.
- Merge phone calls, the PC and connected mobile phone into a hybrid UC conference.
- Answer calls from the softphone.

 **Note:** You can install a softphone (for example, Yealink VC Desktop) on PC to make calls.

It is only applicable to CP930W.

- [Connecting the PC to the Phone](#)
- [Setting the Phone as PC Audio Device](#)
- [Setting the Phone as PC Audio Device via Softphone](#)
- [Setting the Phone as PC Audio Device via PC](#)
- [Placing Calls via PC](#)
- [Holding/Resuming the PC Audio](#)
- [Muting/Unmuting the Microphone](#)

### Related tasks

[Creating a Hybrid UC Meeting with Mobile Phone and PC](#)

## Connecting the PC to the Phone

---

You can connect the PC to the phone to play the PC audio.

### Procedure

Connect the phone to a PC using a micro USB cable.

- When your phone is idle, the phone screen is shown below:

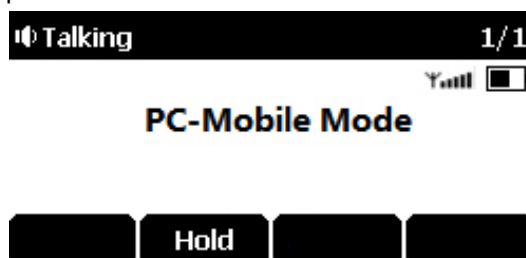

- When there is a call or conference call on your phone, the original call or conference call is placed on hold.
- When you are placing a call, the dialing is canceled.

 **Note:** When you connect the PC to the phone, the phone is also charged at the same time.

## Setting the Phone as PC Audio Device

---

By default, the PC automatically selects the connected phone as the audio device. If not, you may have to set the phone as a PC audio device via softphone or PC.

## Setting the Phone as PC Audio Device via Softphone

---

When your PC is connected to the phone, you can set the phone as a PC audio input and an output device via the softphone, for example, Yealink VC Desktop.

### Procedure

1. In the top-left corner of the window, click the avatar icon to enter the settings window.
2. Click **Device**.
3. Select your phone from the **Speaker** drop-down menu.
4. Select your phone from the **Microphone** drop-down menu.
5. Optional: Click **Test** to test the microphone or the speaker.

## Setting the Phone as PC Audio Device via PC

---

When your PC is connected to the phone, you can set the phone as the PC default audio device via PC.

### Procedure

1. Click **Start > Control Panel > Sound**.
2. Click **Echo Cancelling Speakerphone (Yealink CP930W Speakerphone)** and click **Set as Default Device**.
3. Click **Microphone (Yealink CP930W Speakerphone)** and click **Set as Default Device**.
4. Confirm the action.

## Placing Calls via PC

---

If you have installed a softphone (for example, Yealink VC Desktop) on PC, you can place calls and the phone acts as a microphone and a speaker.

### Before you begin

Make sure you have set your phone as the PC audio device.

### Procedure

1. Make the call (or answer an incoming call) using the installed softphone on PC.

*The microphone is automatically activated on your phone.*

2. End the call on the softphone.

*The phone now only functions as a speaker for the PC.*

## Holding/Resuming the PC Audio

---

When you place the PC audio on hold, you cannot hear any audio on your phone.

### Procedure

1. Select **Hold** to hold the call.
2. Select **Resume** to resume the call.

## Muting/Unmuting the Microphone

---

When you mute the microphone during a call, the other party cannot hear you but you can hear other parties.

### Procedure

1. Tap the Mute touch key.

*The mute touch key LED indicators glow red.*

2. Tap the Mute touch key again to unmute the microphone.

## WH62/WH63 Headsets

---

You can register the WH62/WH63 headsets to the DM to answer the incoming calls or pair them with the handsets. This chapter will take WH62 as an example.

- [Switching Mode](#)
- [Registering the Headset](#)
- [Pairing the Headset with a Handset](#)
- [Using the Headset to Manage Calls](#)

## Switching Mode

---

The WH62/WH63 have two modes: Multi-Cell mode and Normal headset mode. Under the Multi-Cell mode, the Voice button will turn solid white; under the normal headset mode, the PC button will turn solid white.

### About this task

Please ensure the headsets are in the Multi-Cell mode to enable this function.

### Procedure

Hold the Voice button and Phone button of the headset base for 5 seconds. The LED on the headset base will flash four times, and at last, the Voice button will turn solid white.

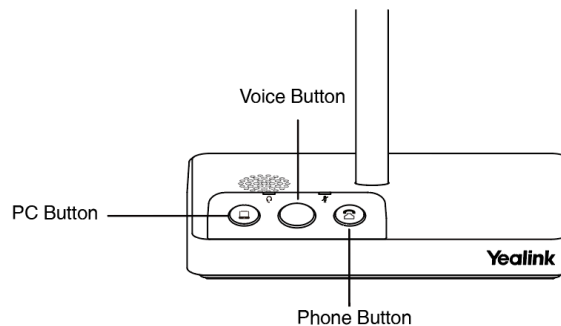

After you switching the headset mode to multi-cell mode, you can register it on the DM.



**Note:** If you purchase WHM621 with Charging Cable/WHD622 with Charging Cable/WHM631 with Charging Cable (coming soon), the package does not contain a base, and you can register directly without switching mode.

## Registering the Headset

### Procedure

1. On the web user interface, go to **Handset & Account > Handset Registration**.
2. Click **Add Handset**.
3. Click **Start Register Handset** to set the DM to the registration mode.
4. Reboot the headset, undock the headset from the base and hold the Call Control button for 3 seconds to power off and hold the Call Control button for 3 seconds again to power on.

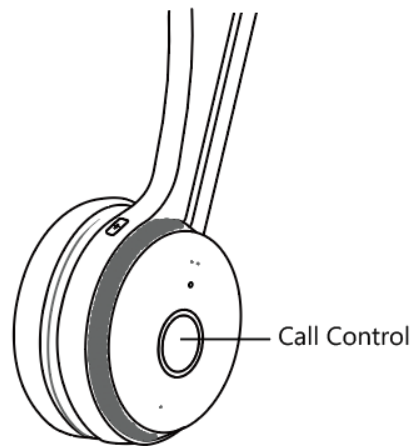

5. Hold the Call Control button for 5 seconds to put the headset into registration mode, as indicated by orange flashes and the voice prompt announcing "pairing mode". After opening the registration mode, the headset will automatically register to the DM.



**Note:** If you do not register within 2 minutes, the headset will shut down due to a timeout and you will need to reboot again.

6. You can check the registration status on the **Handset Registration**.

The screenshot shows the "Handset Registration" page in the Yealink W80DM web interface. The page displays a table of registered handsets. The first row is highlighted with a red border, indicating a registered handset.

#	IPUI	HS Status	Paired Status	SIP Account	Account Status	HS Type	Operation
1	0291CF43A	Registered	NA	6262	Registered	WH62	[Icons]
2	0291EEFC49	Registered	-	5757	Registered	W57R	[Icons]

Summary: Registered Handsets: 2 | 250, Registering Handset: N/A, Handsets With SIP Account: 2. Total: 2, Page: 10, Go to: 1.

7. After you register the headset in the system, you can use it to answer the incoming calls.

## Pairing the Headset with a Handset

You can also pair the headset with a handset registered on the DM. The headset will get the same extension number as the handset.

## About this task

Please ensure that you have registered the headset and handset to the DM. For more information about registering handsets, please refer to [Registering the Handset](#).

## Procedure

1. On the web user interface, go to **Handset & Account > Handset Registration**.
2. Select the handset you want to pair with the headset, go to **Edit > Paired Terminal**, and select the corresponding headset from the drop-down menu.

Handset 3 & Account 3

**Handset**

Handset Name

IPUI

Paired Terminal

**Account**

Register status

Line Active

Label

Display Name

Register Name

Username

Password

3. Click **OK**. The headset is now registered with the same extension number as the handset.

## Using the Headset to Manage Calls

After you pair the headset with a handset, you can use it to manage calls, for example, push calls, retrieve calls and redial.

### Procedure

1. **Push:** When receiving an incoming call, both the headset and handset will ring. If you answer the call in the handset, go to **Options > Push** on the handset, you can push the call to the headset.
2. **Retrieve:** If you answer the call in the headset, hold the **TRAN** key on the headset, you can retrieve the call to the handset.
3. **Redial:** Double tap the **Call Control** button on the headset. You can directly call the last call record.

# Maintaining Your Phone

---

When your phone cannot operate properly, you need to investigate or troubleshoot issues along with other tasks that your administrator may ask you to perform.

- [Investigating Warnings](#)
- [Resetting the Handset](#)
- [Rebooting the Handset](#)

## Investigating Warnings

---

When the default password is used on the phone, you can view the warning details about the issue from Status screen.

### Procedure

Go to **OK > Status > DM**.

On the CP930W/DD phone, go to **Menu > Status > DM (DM Status)**.

*The warning detail is displayed in the **Warning (Warnings)** field.*

## Resetting the Handset

---

You can reset individual settings that you have configured on the handset.

Except the settings of directory, call history, voice mail, and the handset registration, the handset will reset all customized settings to factory after the resetting.

### Procedure

1. Go to **OK > Settings > System Settings > Handset Reset**.

On the CP930W, go to **Menu > Settings > Advanced Settings (default PIN: 0000) > Handset Reset**.

On the DD phone, go to **Menu > Settings > Advanced Settings (default PIN: 0000) > Reset Config > Reset Handset Settings**.

*The phone prompts you whether to reset the handset.*

2. Confirm the action.

## Rebooting the Handset

---

The improper operation may cause malfunction. If the malfunction occurs, your system administrator may ask you to reboot your phone.

### About this task

It is only applicable to CP930W/DD phone.

### Procedure

1. Go to **Menu > Settings > Advanced Settings (default PIN: 0000) > Handset Reboot.**

On the DD phone, go to **Menu > Settings > Advanced Settings (default PIN: 0000) > Reboot Config > Handset Reboot.**

*The phone prompts whether to reboot the phone.*

2. Confirm the action.

## Appendix

---

- [Appendix A- Menu Structure](#)
- [Appendix B - Input Modes and Characters](#)
- [Appendix C - Bluetooth Headset Compatibility List](#)

### Appendix A- Menu Structure

---

- [For W56H/W53H/W73H](#)
- [For W73H](#)
- [For W78H](#)
- [For W57R/W59R](#)
- [For CP930W](#)
- [For CP935W](#)
- [For DD Phone](#)

# For W56H/W53H/W73H

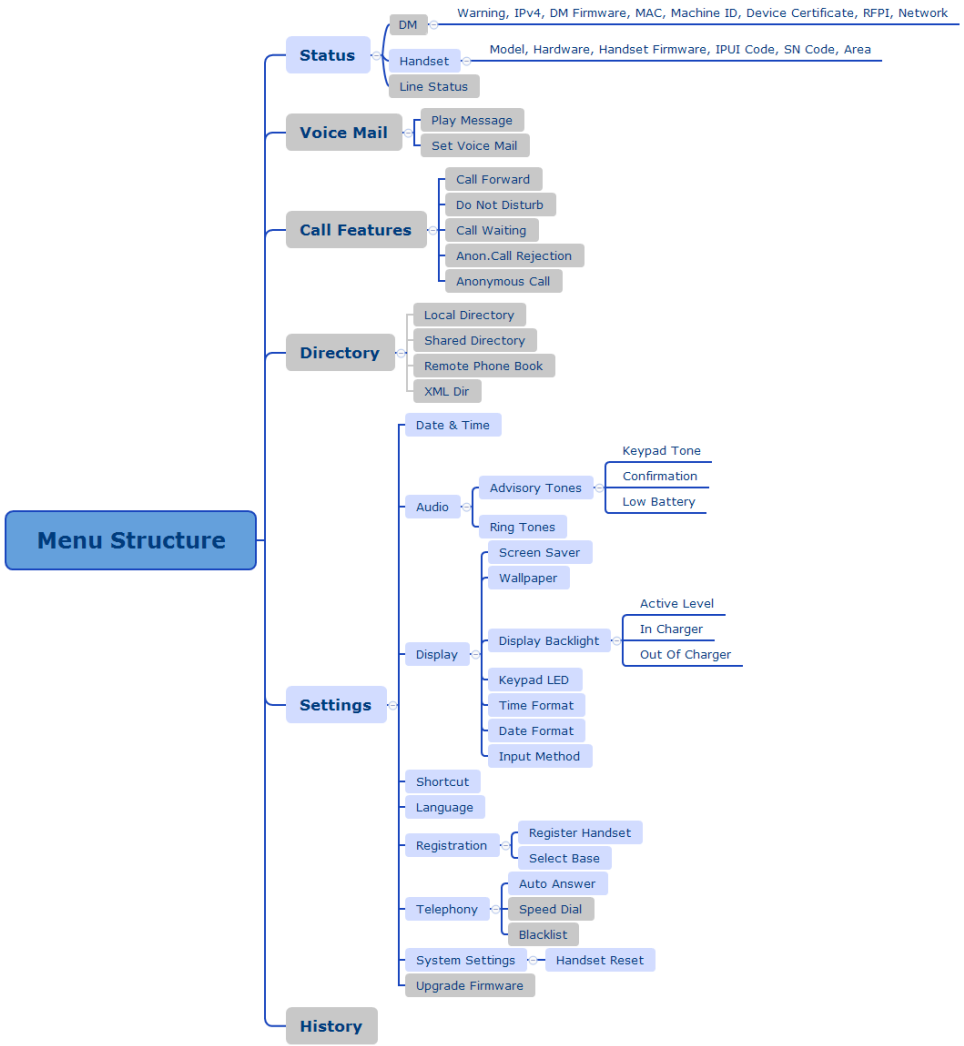

 **Note:** The menus in the gray box are not available when the handset is not registered to a base station.

# For W73H

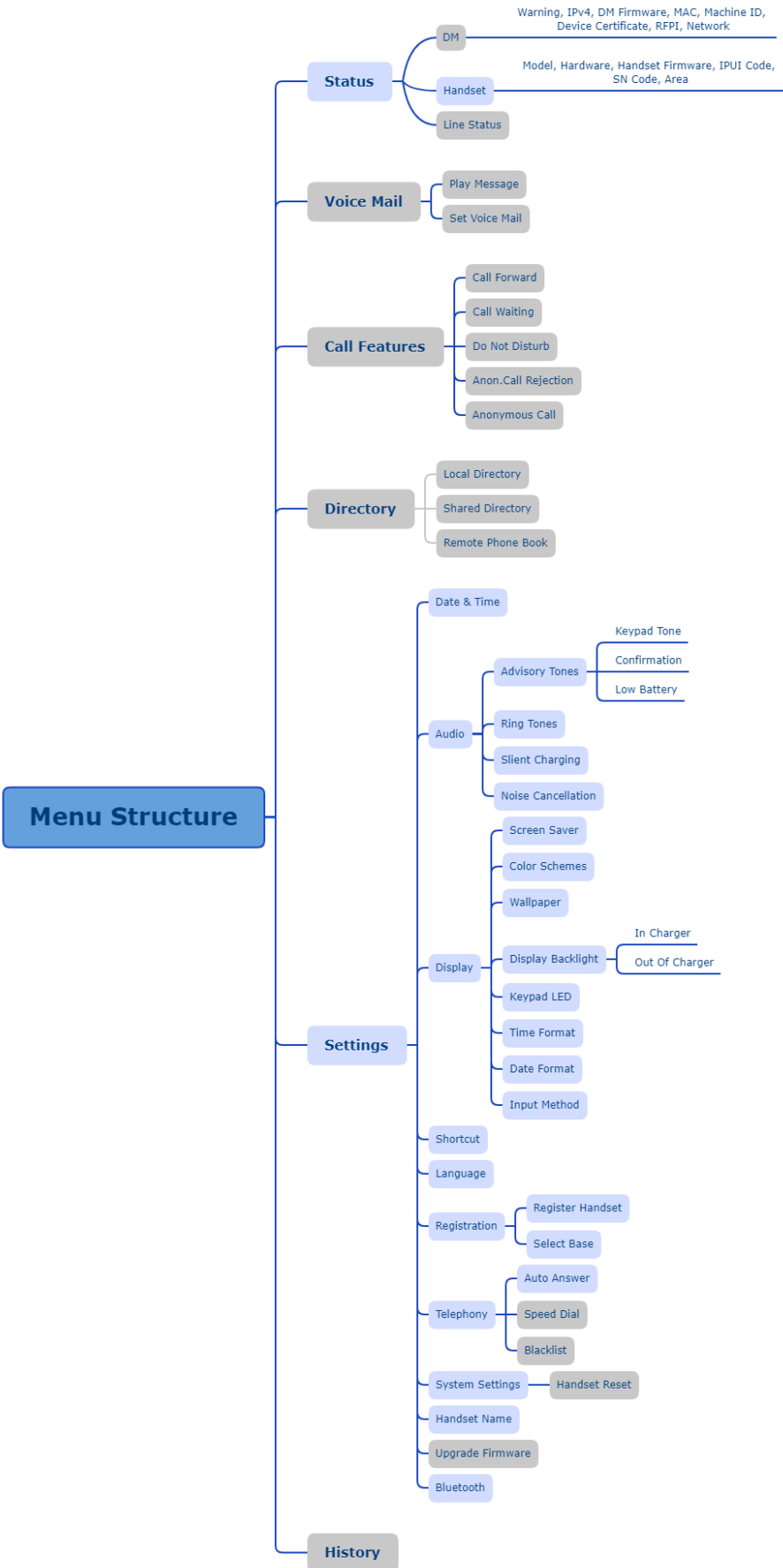



**Note:** The menus in the gray box are not available when the handset is not registered to a base station.

For W78H

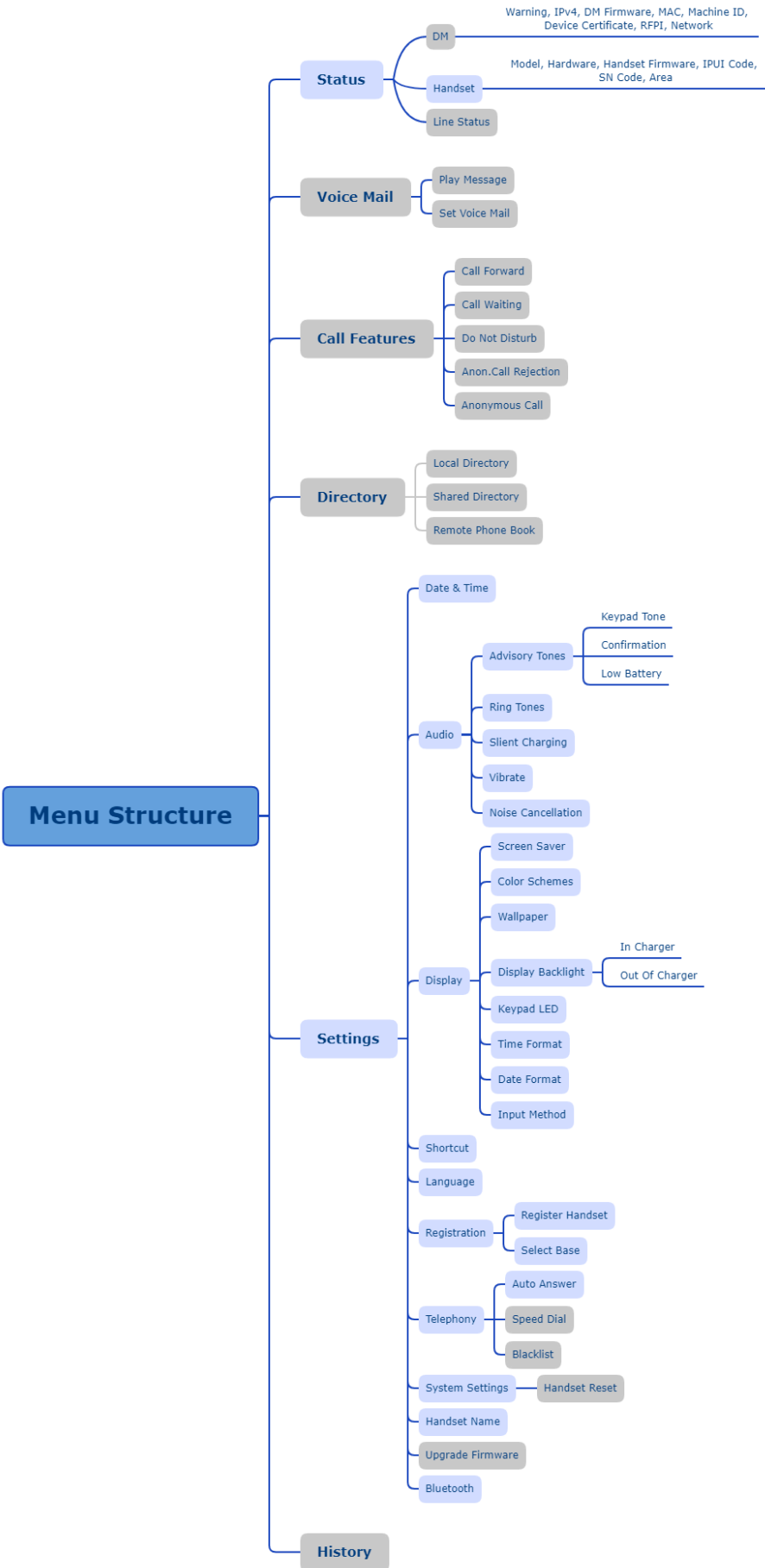



**Note:** The menus in the gray box are not available when the handset is not registered to a base station.

### For W57R/W59R

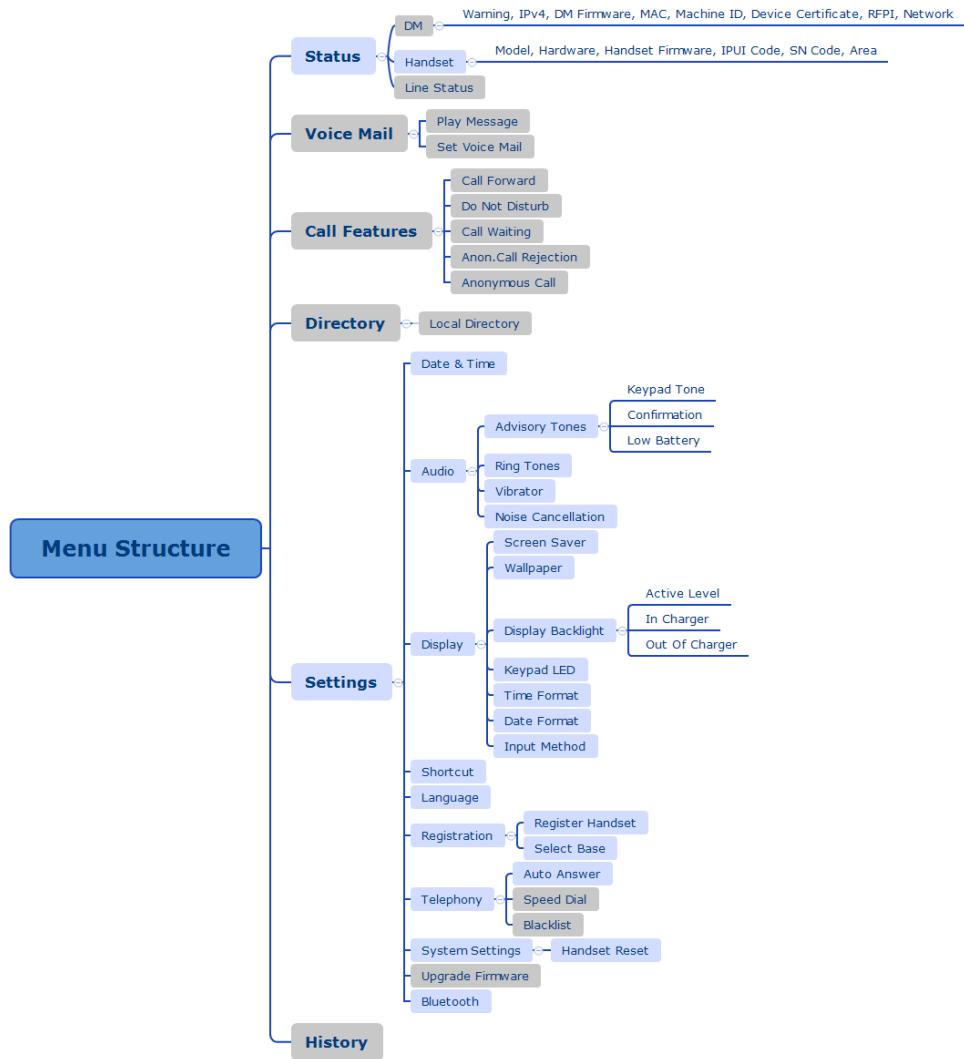

**Note:** The menus in the gray box are not available when the handset is not registered to a base station.

# For CP930W

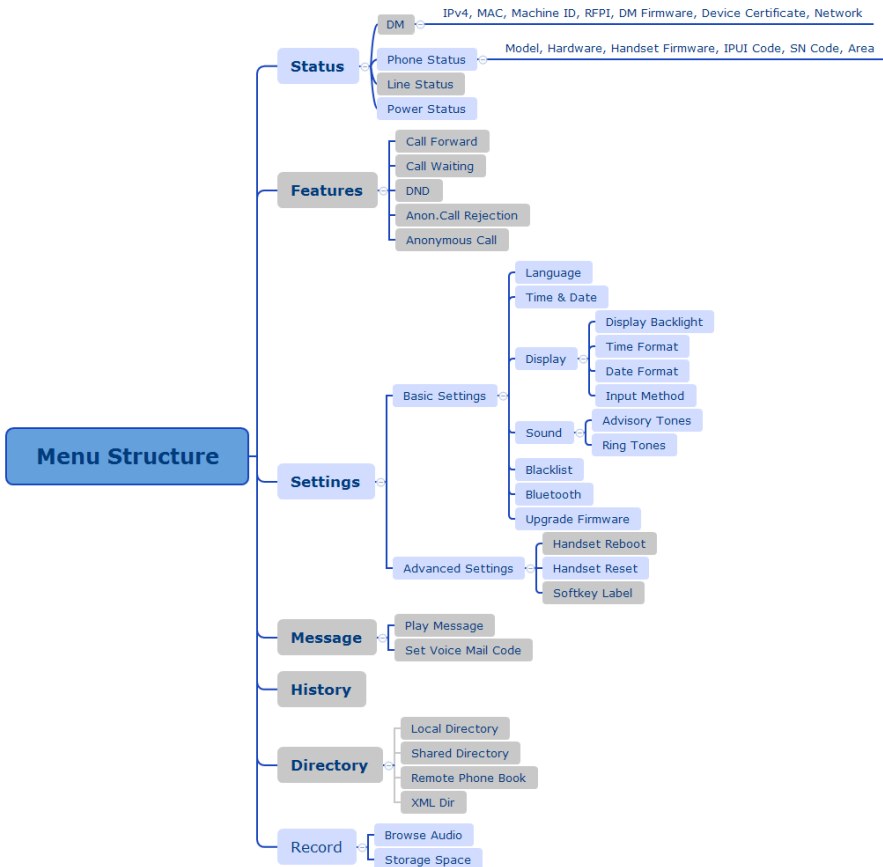

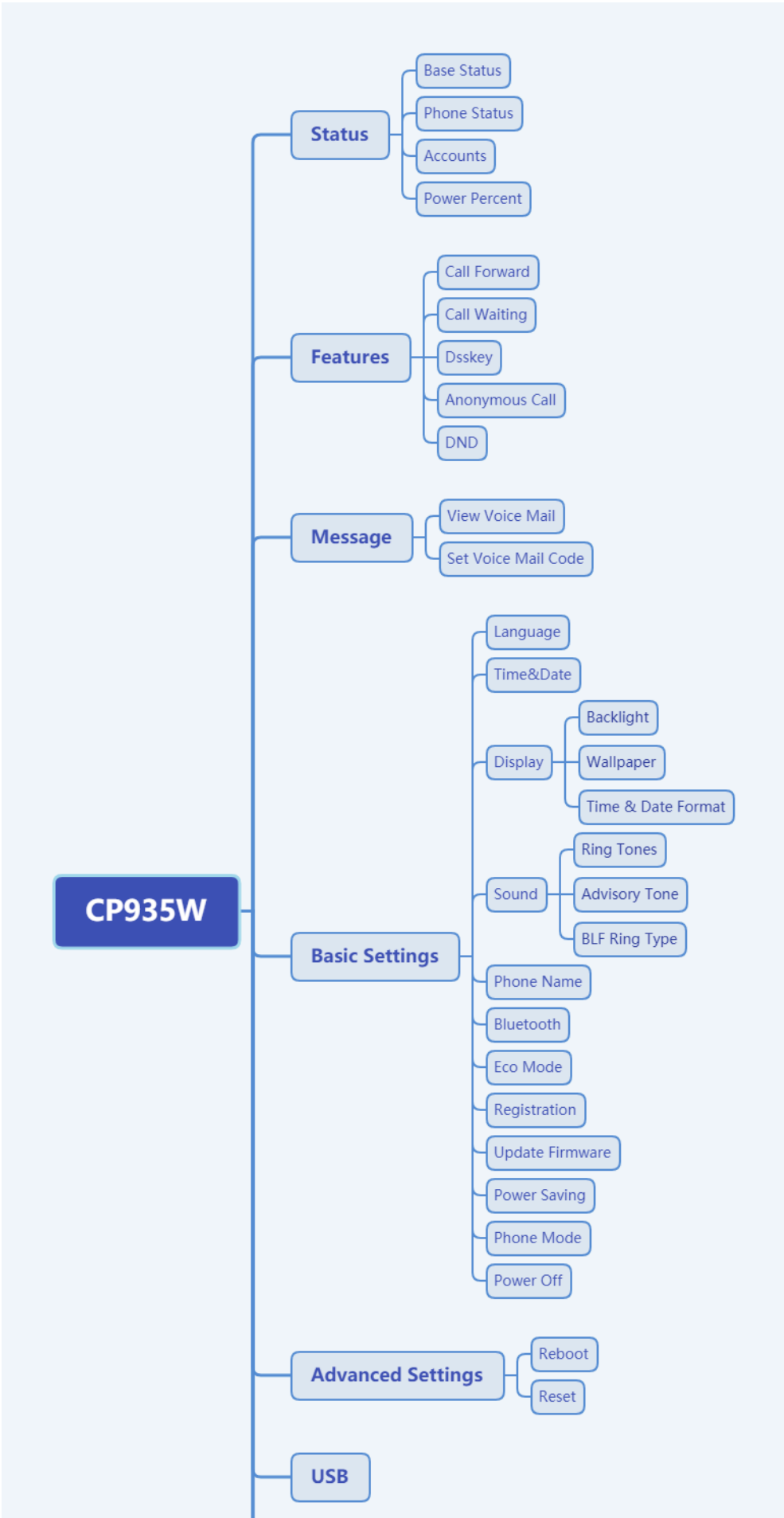

**Note:** The menus in the gray box are not available when the handset is not registered to a base station.

For CP935W

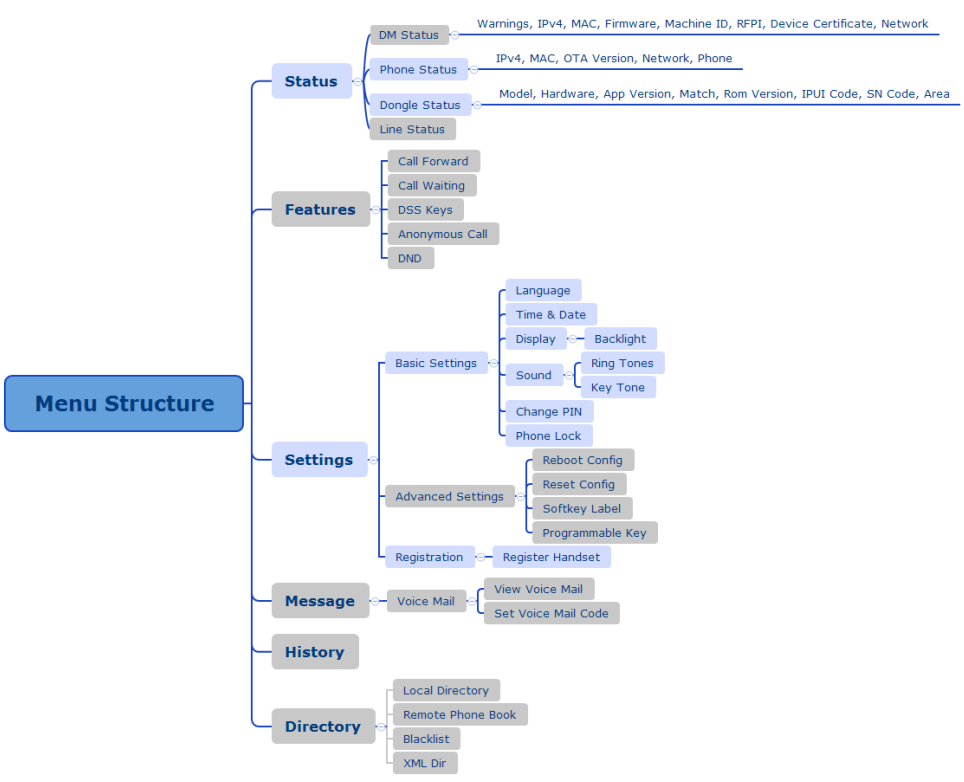

### For DD Phone



 **Note:** The menus in the gray box are not available when the handset is not registered to a base station.

### Appendix B - Input Modes and Characters

	Abc (initials in capitals)	123	ABC	abc	ΑΒΓ	ÄÅ	äå	Šš	šš	абв	АБВ	אבג
1	1	1	1	1	1	1	1	1	1	1	1	1
2	ABCabc2	2	ABC2	abc2	ΑΒΓ2	ÄÄÄÄÄÄ ÅÅÅÅÅÅ	äääääää åååååå	ŠŠŠŠŠŠ šššššš	šššššš šššššš	АБВГ2	абвг2	אבג2
3	DEFdef3	3	DEF3	def3	ΔΕΖ3	DEÉÉÉÉ ËËËËËË	deèèèè ëëëëëë	DĎĎĎĎĎ ĎĎĎĎĎĎ	dd'ee ëëf3	ДЕЖЗ3	дежз3	אבג
4	GHIghi4	4	GHI4	ghi4	ΗΘΙ4	GǦHIÍÍ ÏÏÏÏÏÏ	gǧhiíí ïïïïïï	GHIÍ4	ghií4	ИЙКЛ4	ийкл4	מסנך
5	JKLjkl5	5	JKL5	Jkl5	ΚΛΜ5	JKL5	jkl5	JKLĹĹĹĹ ĹĹĹĹĹĹ	jkĺĺĺĺ ĺĺĺĺĺĺ	МНОП5	мноп5	יכךל
6	MNO mno6	6	MNO6	mno6	ΝΞΟ6	MNŃŃŃŃ ÓÓÓÓÓÓ	mnñoòò óóóóóó	MNŃŃŃŃ ÓÓÓÓÓÓ	mnńńńń óóóóóó	РСТУ6	рсту6	טזח

	Abc (initials in capitals)	123	ABC	abc	ΑΒΓ	ÄÅ	ää	Šš	šš	абв	АБВ	אבג
7	PQRS pqrs7	7	PQRS7	pqrs7	ΠΡΣ7	PQRSSß7	pqrssß7	PQRŘŘ ŠŠŠ7	pqrřř ššš7	ФХЦЧ7	фхцч7	רשת
8	TUVtuv8	8	TUV8	tuv8	ΤΥΦ8	TUÛÚÛ ÜÛV8	tuûúû üûv8	TŤUÚÛ ŮÛV8	tt'uuü úûv8	ШЩ ЪЫ8	шщъы8	קצק
9	WXYZ wxyz9	9	WXYZ9	wxyz9	ΧΨΩΥ9	WŴX ŶŸZ9	wŵx yÿz9	WXYŸŸ ZŹZŹ9	wxyÿÿ zÿzÿ9	БЭЮЯ9	бэюя9	סעפך
0	space.,?! 0	0	0.,?! space	0.,?! space	space 0	space 0	space 0	space 0	space 0	0 ГЄІŸ	0гєіÿ	space 0
*	space = / \ ^ ; : . , - + * # \$ % @ ? ! ı i ( ) { } [ ] < > ¥ \$ £   ~ ª	space ' " = / \ ^ ; : . , - + * # \$ % @ ? ! ı i ( ) { } [ ] < > ¥ \$ £   ~ ª	space ' " = / \ ^ ; : . , - + * # \$ % @ ? ! ı i ( ) { } [ ] < > ¥ \$ £   ~ ª	space ' " = / \ ^ ; : . , - + * # \$ % @ ? ! ı i ( ) { } [ ] < > ¥ \$ £   ~ ª	space ' " = / \ ^ ; : . , - + * # \$ % @ ? ! ı i ( ) { } [ ] < > ¥ \$ £   ~ ª	space ' " = / \ ^ ; : . , - + * # \$ % @ ? ! ı i ( ) { } [ ] < > ¥ \$ £   ~ ª	space ' " = / \ ^ ; : . , - + * # \$ % @ ? ! ı i ( ) { } [ ] < > ¥ \$ £   ~ ª	space ' " = / \ ^ ; : . , - + * # \$ % @ ? ! ı i ( ) { } [ ] < > ¥ \$ £   ~ ª	space ' " = / \ ^ ; : . , - + * # \$ % @ ? ! ı i ( ) { } [ ] < > ¥ \$ £   ~ ª	space ' " = / \ ^ ; : . , - + * # \$ % @ ? ! ı i ( ) { } [ ] < > ¥ \$ £   ~ ª	space ' " = / \ ^ ; : . , - + * # \$ % @ ? ! ı i ( ) { } [ ] < > ¥ \$ £   ~ ª	space ' " = / \ ^ ; : . , - + * # \$ % @ ? ! ı i ( ) { } [ ] < > ¥ \$ £   ~ ª

### Appendix C - Bluetooth Headset Compatibility List

Brands	Type	Model
Jabra	Bluetooth	Evolve 75
		Evolve 65
		pro9470
		MOTION UC
		STEALTH
		style
		Talk 2
		EASYGo
		Supreme
		Storm
Sennheiser	Bluetooth	PRESENCE UC
		MB Pro 1

Brands	Type	Model
		MB Pro 2
		EZX 60
		MB660 UC
Plantronics	Bluetooth	VOYAGER 4210 UC
		ML20
		ML25
		M165
		Edge
		B825(Focus)
Iphone	Bluetooth	Apple AirPods