

HDMI MULTIVIEWER

MV-H2-0401-10

4K60 MultiView & KVM Switch with
AVoIP Integration

Seamless MultiView & KVM Control
in One Powerful Device



NETVIO

PRODUCT **INTRO**

MV-H2-0401-10

4K60 MultiView & KVM Switch with AVoIP Integration

Seamless MultiView & KVM Control in One Powerful Device

The Netvio MV-H2-0401-10 is a versatile 4K60 MultiView processor and KVM switch, designed for both standalone operation and seamless integration with Netvio JP4 AVoIP systems.

In standalone mode, it connects up to four PCs to a single display, allowing unified keyboard/mouse control and instant switching via hotkeys, IR remote, or OSD menus.

When paired with JP4 AVoIP encoders, it unlocks advanced MultiView layouts (PiP, PBP, Quad) on a single UHD display. Fully compatible with NetvioGo AppBuilder, Crestron, and Q-Sys drivers, it offers ultimate flexibility for control and integration.

With support for 4K@60Hz (4:4:4), 18Gbps HDMI bandwidth, and high-definition audio formats, the MV-H2-0401-10 delivers professional-grade performance for control rooms, conference spaces, and AV environments.

NETVIO

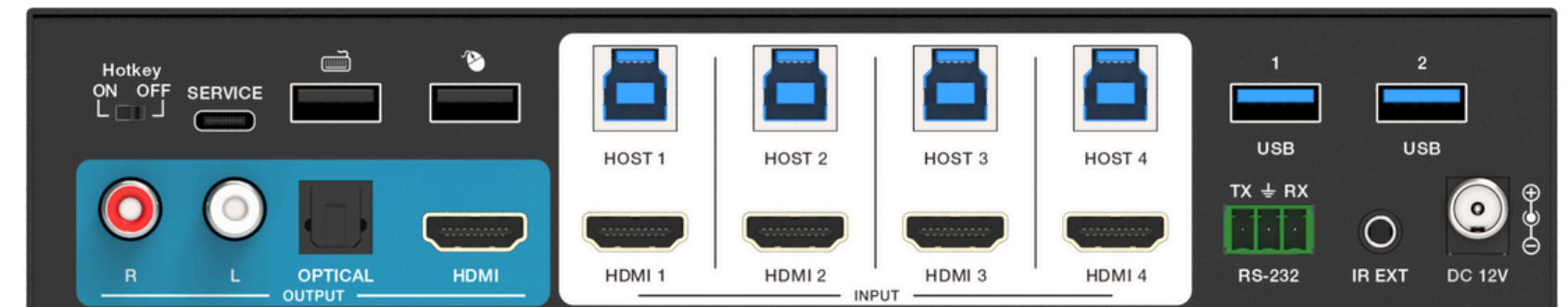

PRODUCT **INFO**

MV-H2-0401-10

4K60 MultiView & KVM Switch with AVoIP Integration

Seamless MultiView & KVM Control in One Powerful Device

Features

- Fully compliant with HDMI 2.0b, HDCP 2.2, and HDCP 1.x
- Supports 18Gbps video bandwidth for uncompressed 4K content
- Resolutions up to 4K@60Hz (4:4:4) supported on both input and output
- Compatible with LPCM, AC3, DD+, DTS, DTS-HD – up to 7.1 channels of high-definition audio
- Seamless input switching with multi-image display on a single UHD monitor
- One Keyboard user controlling up to 4 PCs Offers 8 versatile display modes
- Seamless switching in single-screen mode; fast switching in multiview mode
- On-screen display (OSD) menu for advanced configuration
- Comprehensive EDID management for device compatibility
- Multiple control options:
 - Front panel buttons
 - IR remote
 - OSD menu
 - RS-232 commands
 - NetvioGo (as part of a JP4 Series AVoIP solution)
 - Crestron & Q-Sys Drivers
- Built-In USB3.1 Gen1 Hub for peripherals connection.
- Supports wired and wireless keyboard/mouse array
- Comes with 19" 1U adaptor brackets.

Mechanical

- **Weights & Dimensions (each device)**
 - H:220mm | W:100mm | D: 44mm
 - 443g
- **Power Supply**
 - Input: AC100 - 240V 50/60Hz Output: 12V 2.5A (US/EU, CE/FCC/UL/C-TICK approvals)
- **Power Consumption**
 - 18.48W (max)
- **Operating Temperature**
 - 32 - 104°F / 0 - 40°C
- **Storage Temperature**
 - -4 - 140°F / -20 - 60°C
- **Relative Humidity**
 - 20 - 90% RH (no condensation)
- **Product Certifications**
 - CE, UKCA, FCC

NETVIO

What's in the box

- H2 MultiView Unit
- 1 IR Remote (CR2025 not included)
- 3Pin RS-232 Connectors (cable required)
- IR receiving cable.
- Wall mounted brackets
- 19" Rack mount kit
- USB to 3Pin RS-232 Cable
- 4x USB3.0 cables (PC to Multiview)
- 12V/2.5A Locking Power Supply

MultiView & KVM Solution

Control up to four PCs on a single 4K UHD screen, seamlessly switching with hotkeys, IR remote, or third-party drivers. Ideal for conference rooms, control centers, and professional AV setups.

Standalone or AVoIP

Use as a standalone 4x1 KVM switch or integrate with Netvio JP4 AVoIP for advanced MultiView layouts. Flexible control via NetvioGo, Crestron, Q-Sys, or RS-232 commands.

Professional-Grade Video

Enjoy uncompressed 4K@60Hz (4:4:4), HDMI 2.0b, HDCP 2.2, and 18Gbps bandwidth with full multi-channel audio support. Perfect for mission-critical AV environments needing premium quality and reliability.

Installer-Friendly

Quick to deploy with included wall brackets, rack kit, USB cables, IR extension, and power supply. Supports wired or wireless keyboards and mice for easy, flexible installations anywhere.

REAR PANEL

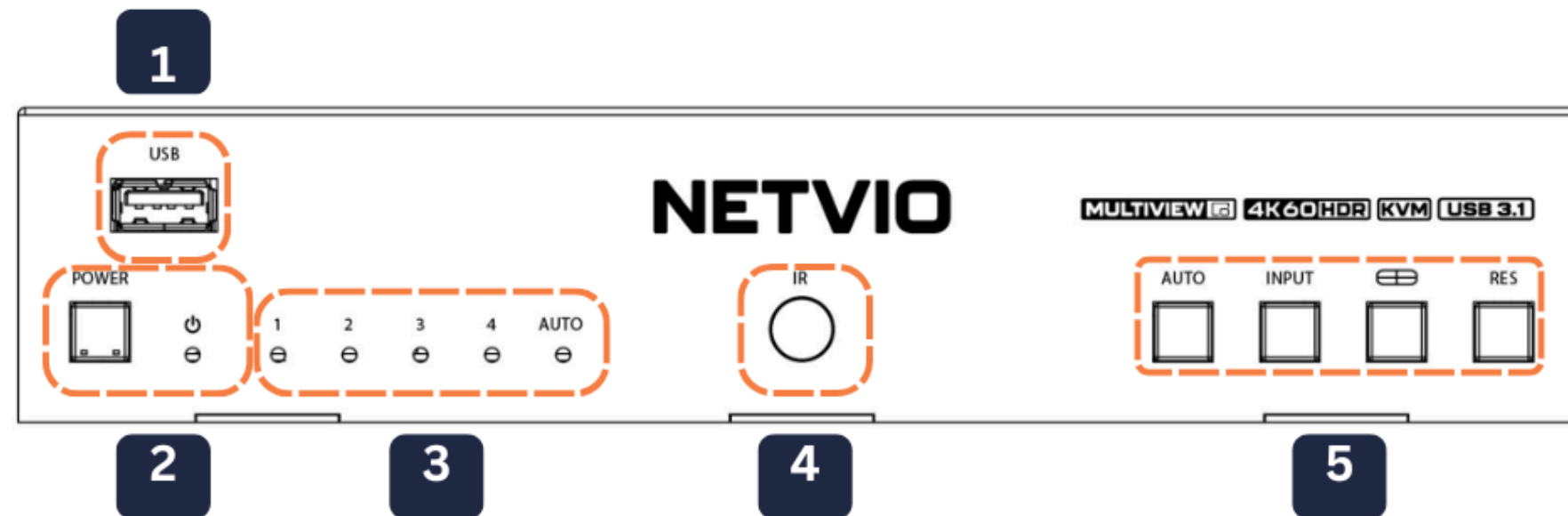

1 USB3.0 Device Input

2 Power button & Status Light | RED Standby | GREEN On

3 Single Screen Output Status. Auto will select last input connected.

4 IR Receiving Window

5 **AUTO** | last Input Detect (Single Screen Mode Only)

INPUT | Sequencing between inputs (Single Screen Mode Only)

MULTIVIEW | Sequencing between different multi-view screen formats.

RESOLUTION | SHORT PRESS: Displays current resolution: LONG PRESS: Changes resolution, for example 1280x782 60Hz

REAR PANEL

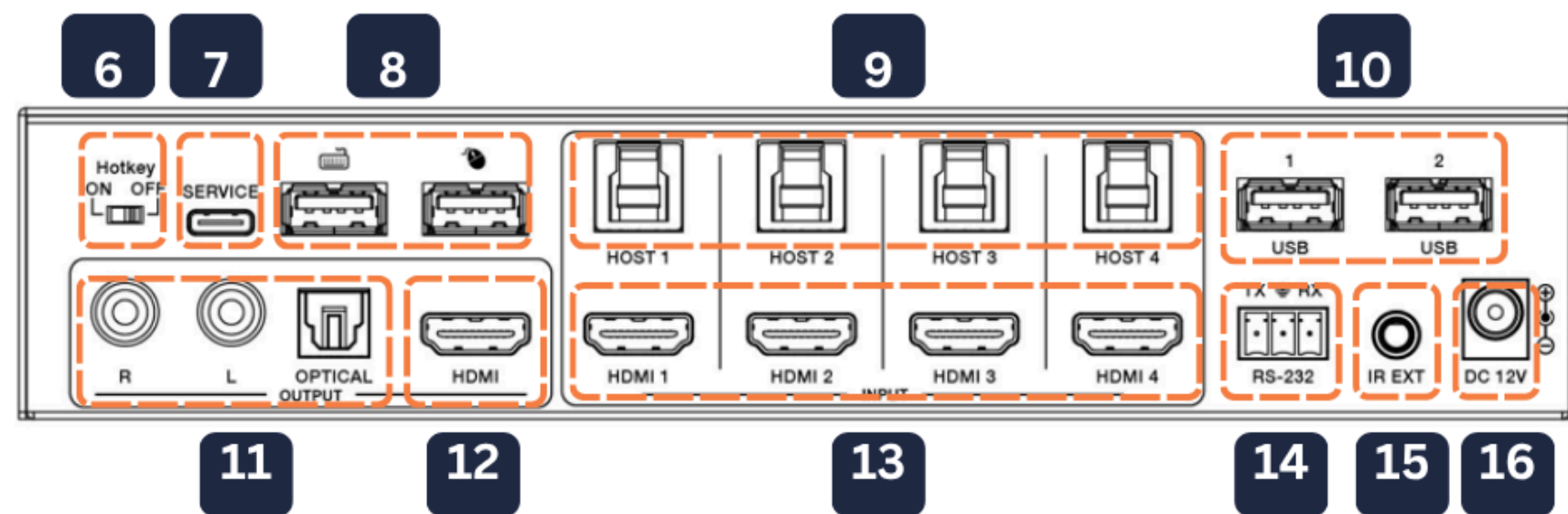

6 HOT KEY FUNCTION On/Off

7 Service Upgrade

8 USB2.0 Keyboard & Mouse Connection

9 USB3.0 Host ports. Requires additional connection of corresponding HDMI

10 USB3.1 Gen1 devices for memory, cameras, printers

11 Analog & Digital outputs for Single screen & Input 1, when if multiview mode.

12 HDMI Output (to display).

13 HDMI Input upto 18Gb 4K60. Correspondence with host ports above.

14 RS-232 port, required for software control (provided) or 3rd party control.

15 Connection for IR Extension cable (provided).

16 Locking PSU connection (12V/2.5A)

MULTIVIEW AVOIP

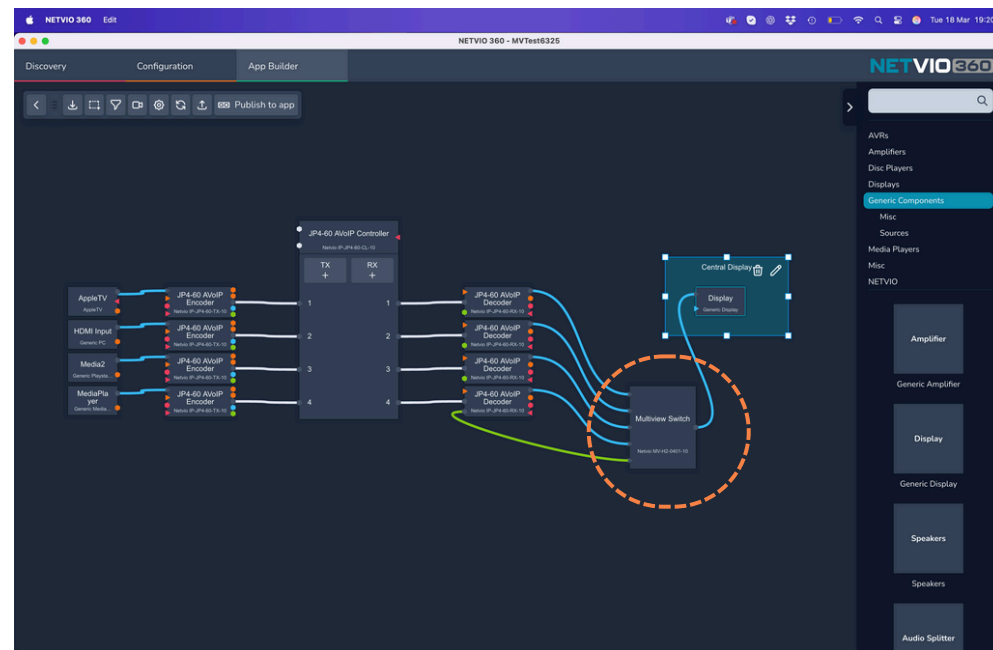

APP BUILDER

Use Netvio's AppBuilder to add the MV-H2-0404-10 to your NetvioGo AVoIP user-interface.

Simply drag the device and connect the lines and Netvio will do the rest.

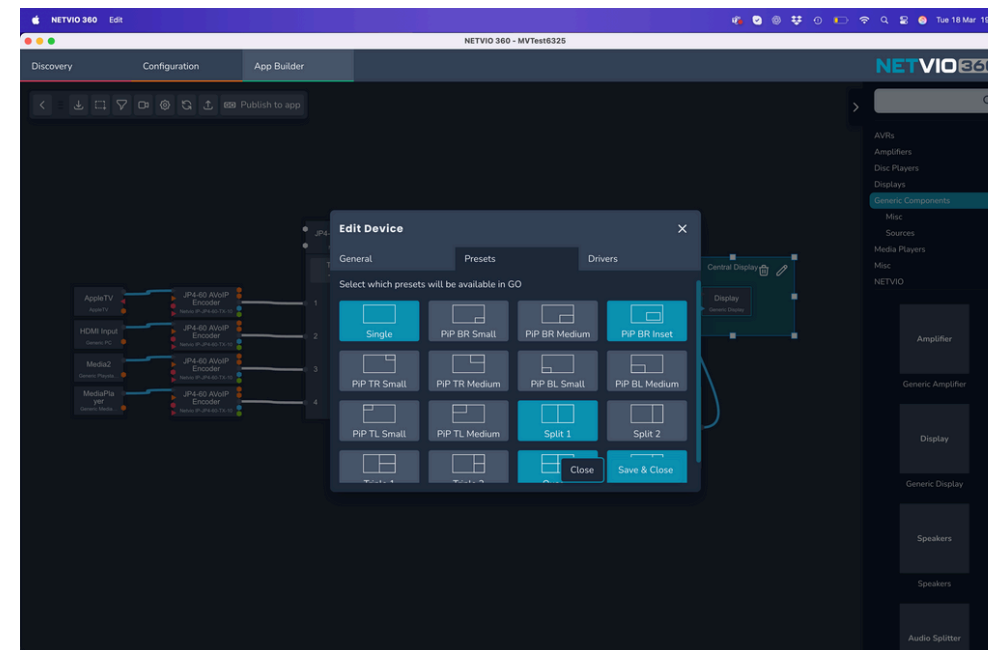

CHOOSE PRESETS

Choose from a array of pre-set MultiView screen formats and make them available within the NetvioGo app user-interface.

Users can quickly recall presets for fast switching and user control.

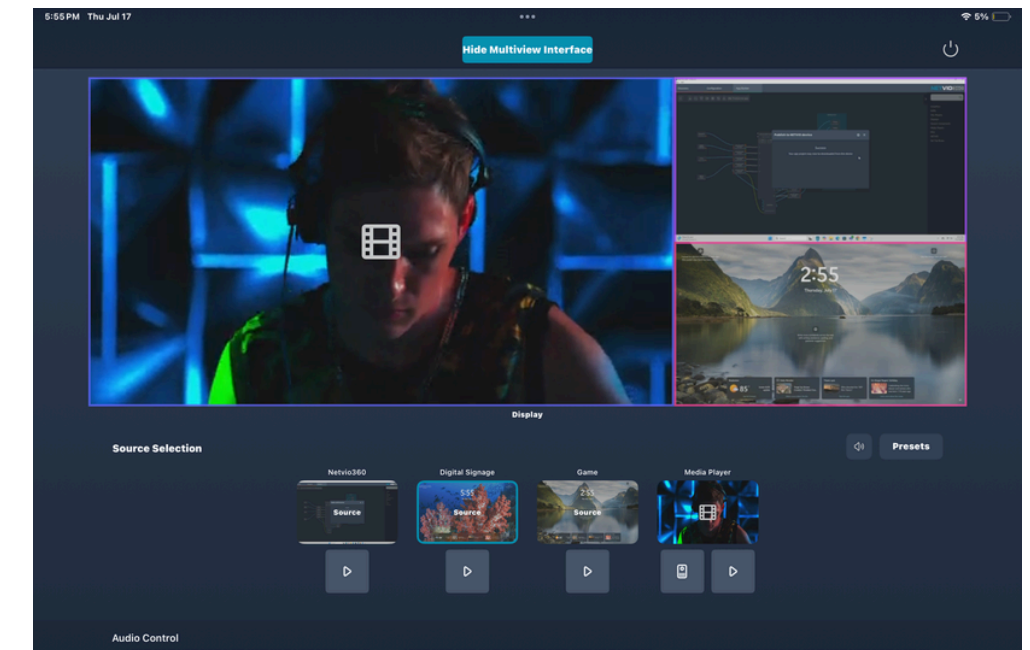

NETVIO GO

Handover an intuitive and easy-to-use application compatible with Apple and Android devices.

Use stunning full motion previews to ensure the correct sources are assigned to any preset.

KVM MODE

SINGLE PIP PBP (1) PBP (2) Triple (1) Triple (2) Quad (1) Quad (2)

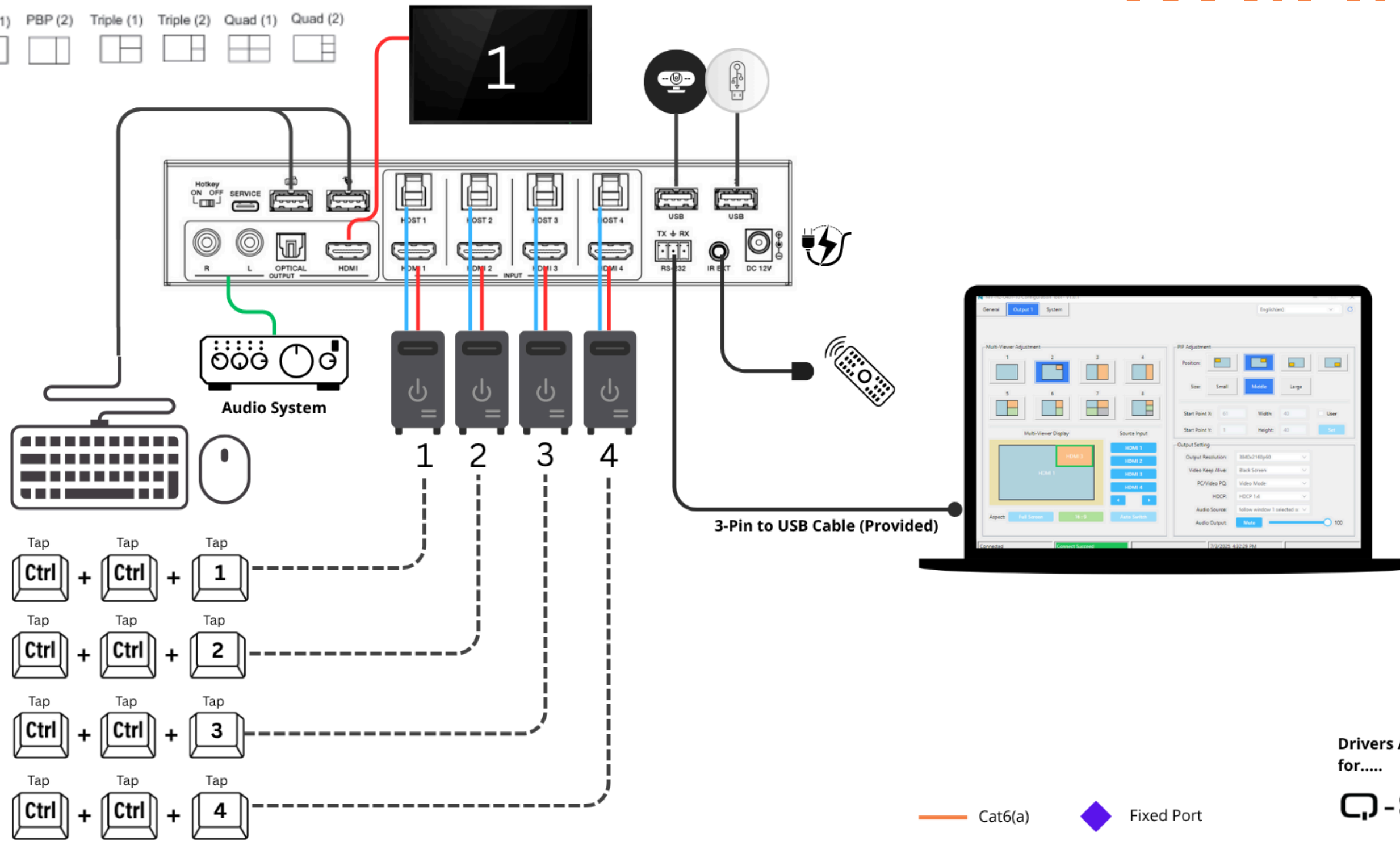

— Cat6(a) ◆ Fixed Port
— RS-232 — HDMI2.0

Drivers Available for.....

Q-SYS

CRESTRON

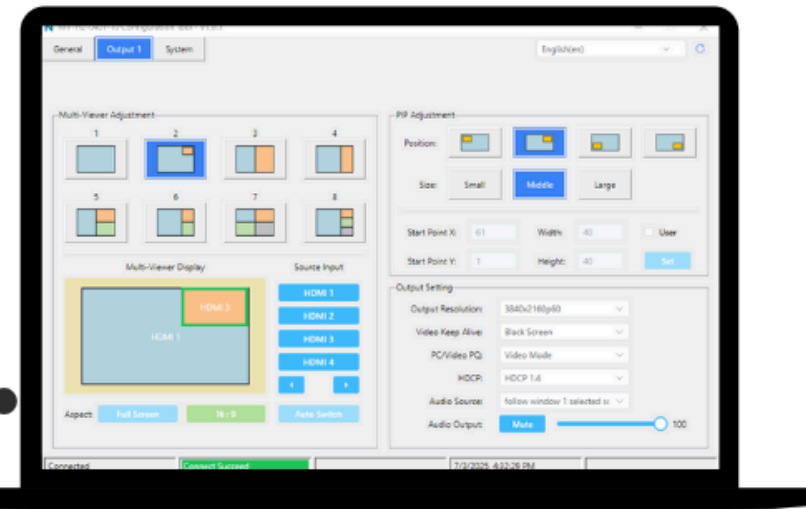

AVOIP MODE

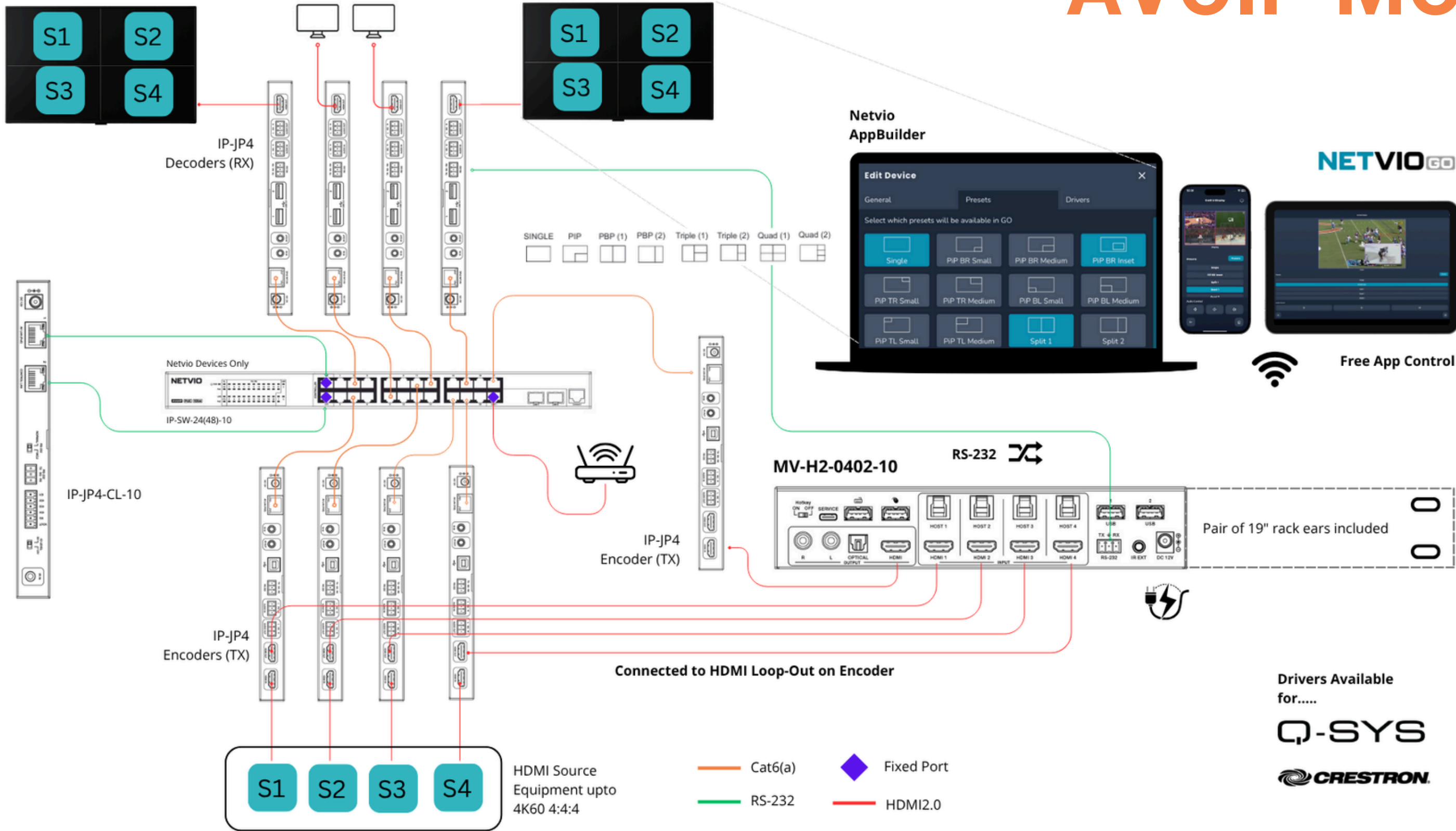

ADVANCED AVOIP MODE

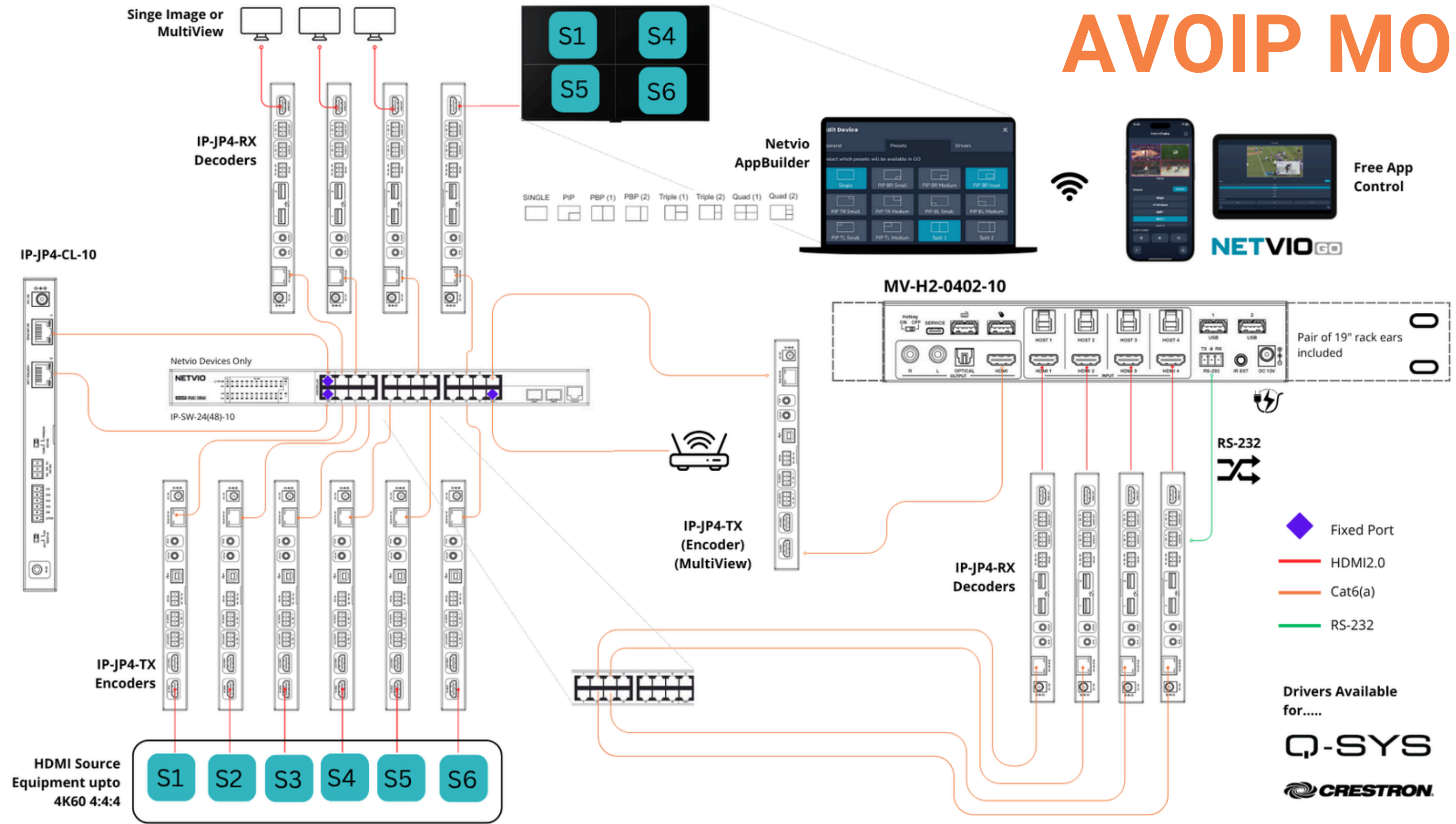

ARCHITECTS

ENGINEERS

NETVIO

MV-H2-0401-10

4K60 MultiView & KVM Switch with AVoIP Integration

Seamless MultiView & KVM Control in One Powerful Device

The unit shall be a 4x1 MultiView processor and KVM switch capable of displaying up to four simultaneous 4K60 (4:4:4) sources on a single UHD display. It shall operate in standalone mode or integrate seamlessly with a Netvio JP4 AVoIP platform for networked source selection.

The device shall support HDMI 2.0b, HDCP 2.2/1.x, and provide an 18Gbps video bandwidth for uncompressed content. Supported resolutions shall include up to 3840x2160 @ 60Hz, with full multi-channel audio compatibility including LPCM, Dolby Digital, DTS, and DTS-HD Master Audio.

The unit shall provide eight MultiView layout modes, including full screen, Picture-in-Picture (PiP), Picture-by-Picture (PBP), 3-window, and Quad View. Seamless input switching shall be available in single-screen mode, while fast switching shall be available in MultiView mode.

Control options shall include front panel buttons, IR remote control, RS-232 commands, on-screen display (OSD), and hotkeys via a connected USB keyboard. When used with Netvio JP4 encoders/decoders, the device shall also be controllable via NetvioGo AppBuilder. Third-party control integration shall be supported via Crestron and Q-Sys drivers.

The unit shall include a built-in USB 3.1 Gen1 hub, supporting wired or wireless keyboards and mice, including models with a single USB receiver. Four USB 3.0 Type-B host ports shall provide keyboard/mouse control for each connected PC.

For professional installation, the device shall include 19" 1U rack-mount brackets, wall-mount brackets, IR extension receiver, and all required RS-232/USB cables. The power supply shall be a locking 12V DC, 2.5A adapter with universal AC 100-240V input and CE/FCC/UL approvals.

Environmental specifications shall include an operating temperature range of 0°C to 40°C (32°F to 104°F), storage temperature -20°C to 60°C (-4°F to 140°F), and 20-90% relative humidity, non-condensing. The unit shall have overall dimensions of 220mm (W) x 100mm (D) x 44mm (H) and a net weight not exceeding 443g.

The product shall be CE, UKCA, and FCC compliant, conforming to RoHS and WEEE environmental directives. It shall be covered by a standard 5-year manufacturer's warranty.

The product shall be the Netvio MV-H2-0401-10 or approved equal.