



# Surface Mount

**Elegantly integrate iPad® onto any surface.**

iPad is everywhere - in businesses and in homes. There are thousands of smart devices available that help make your life better. All these devices come to life on your iPad screen where you can control them as you desire. We believe there

should be an easy way to place your iPad onto any surface, keeping it charged and always available. Turn your iPad into a smart touch panel with Surface Mount, the elegant frame that allows you to integrate iPad onto any surface.

## BEZELS



### For iPad mini 3 | 2 | 1

- Precision machined aluminum bezel
- Easily mounts on any surface
- Security lock

SKU - #70700 (black)  
SKU - #70701 (silver)  
SKU - #70702 (white)



### For iPad mini 4

- Precision machined aluminum bezel
- Easily mounts on any surface
- Security lock

SKU - #70722 (black)  
SKU - #70723 (silver)  
SKU - #70724 (white)



### For iPad Air 2 | 1

- Precision machined aluminum bezel
- Easily mounts on any surface
- Security lock

SKU - #70703 (black)  
SKU - #70704 (silver)  
SKU - #70705 (white)



### For iPad Pro 12.9"

- Precision machined aluminum bezel
- Easily mounts on any surface
- Security lock

SKU - #70743 (black)  
SKU - #70744 (silver)  
SKU - #70745 (white)

Learn more at [iportproducts.com/SurfaceMount](http://iportproducts.com/SurfaceMount)

## POWER OPTIONS



### PoE Splitter (sold separately)

The PoE splitter is designed to provide the necessary power to the iPad's Lightning Connector from a PoE or direct 24V power source.

SKU - #70718



### PoE Injector (sold separately)

The PoE injector is designed to provide power via PoE IEEE 802.3af and is required if there is no other PoE or 24V power source.

SKU - #70719

### PoE Switch



### 24V

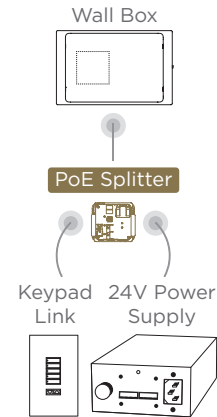

### Receptacle

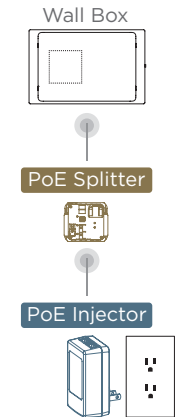

Power iPad via PoE (Power over Ethernet), low voltage (24V DC) or from a wall receptacle.

Power Options	PoE Splitter	PoE Injector
PoE Switch	●	
24V	●	
Receptacle	●	●

## SKU KITS

### A La Carte

MODEL	COLOR	SKU
Bezel mini 3   2   1	Black	70700
Bezel mini 3   2   1	Silver	70701
Bezel mini 3   2   1	White	70702
Bezel mini 4	Black	70722
Bezel mini 4	Silver	70723
Bezel mini 4	White	70724
Bezel Air 2   1	Black	70703
Bezel Air 2   1	Silver	70704
Bezel Air 2   1	White	70705
Bezel Pro 12.9"	Black	70743
Bezel Pro 12.9"	Silver	70744
Bezel Pro 12.9"	White	70745
PoE Splitter	-	70718
PoE Injector	-	70719
Glass Mounting Kit	-	70720

### Bundle Kits

MODEL	COLOR	SKU
Bezel mini 3   2   1 + Splitter + Injector	Black	70725
Bezel mini 3   2   1 + Splitter + Injector	Silver	70726
Bezel mini 3   2   1 + Splitter + Injector	White	70727
Bezel mini 4 + Splitter + Injector	Black	70731
Bezel mini 4 + Splitter + Injector	Silver	70732
Bezel mini 4 + Splitter + Injector	White	70733
Bezel Air 2   1 + Splitter + Injector	Black	70728
Bezel Air 2   1 + Splitter + Injector	Silver	70729
Bezel Air 2   1 + Splitter + Injector	White	70730
Bezel Pro 12.9" + Splitter + Injector	Black	70749
Bezel Pro 12.9" + Splitter + Injector	Silver	70750
Bezel Pro 12.9" + Splitter + Injector	White	70751
Bezel mini 3   2   1 + Splitter	Black	70734
Bezel mini 3   2   1 + Splitter	Silver	70735
Bezel mini 3   2   1 + Splitter	White	70736
Bezel mini 4 + Splitter	Black	70740
Bezel mini 4 + Splitter	Silver	70741
Bezel mini 4 + Splitter	White	70742
Bezel Air 2   1 + Splitter	Black	70737
Bezel Air 2   1 + Splitter	Silver	70738
Bezel Air 2   1 + Splitter	White	70739
Bezel Pro 12.9" + Splitter	Black	70746
Bezel Pro 12.9" + Splitter	Silver	70747
Bezel Pro 12.9" + Splitter	White	70748

## SURFACE MOUNT SPECIFICATIONS

### Bezel Pro 12.9"

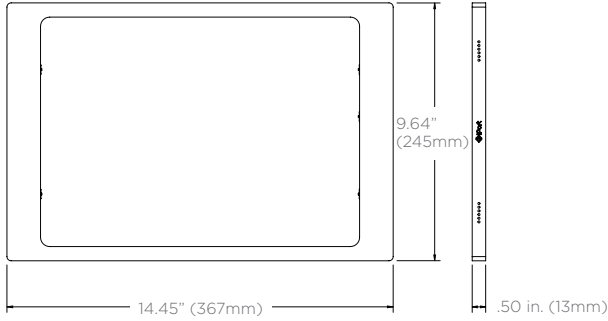

#### Dimensions

Weight: 2.41 lbs  
(Bezel & mounting plate)  
Height: 9.64"  
Width: 14.45"  
Depth: .50"

#### Compatibility

- Works with iPad Pro 12.9"

#### What's in the Box

- Bezel & mounting

#### SKU (Black)

#70743 (Bezel only)

#### SKU (Silver)

#70744 (Bezel only)

#### SKU (White)

#70745 (Bezel only)

### Bezel Air 2 | 1

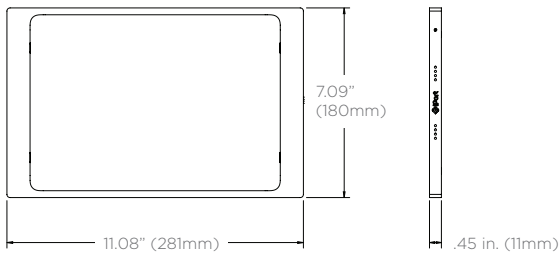

#### Dimensions

Weight: 0.96 lbs  
(Bezel & mounting plate)  
Height: 7.09"  
Width: 11.08"  
Depth: 0.45"

#### Compatibility

- Works with iPad Air 2 | 1

#### What's in the Box

- Bezel & mounting

#### SKU (Black)

#70703 (Bezel only)

#### SKU (Silver)

#70704 (Bezel only)

#### SKU (White)

#70705 (Bezel only)

### Bezel mini 4 | 3 | 2 | 1

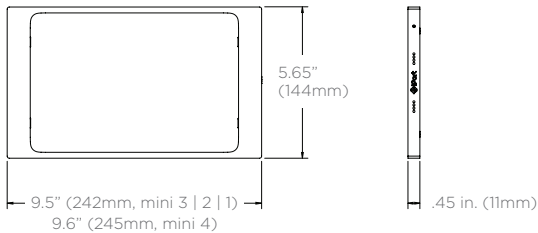

#### Dimensions

Weight: 0.69 lbs  
(Bezel & mounting plate)  
Height: 5.65"  
Width: 9.5"  
(Surface Mount iPad 3, 2, 1)  
Width: 9.6"  
(Surface Mount iPad 4)  
Depth: 0.45"

#### Compatibility

- Works with iPad mini 4 | 3 | 2 | 1

#### What's in the Box

- Bezel & mounting hardware
- Quickstart Guide
- Manual

#### SKU (Black mini 4)

#70722 (Bezel only)

#### SKU (Silver mini 4)

#7072 (Bezel only)

#### SKU (White mini 4)

#70724 (Bezel only)

#### SKU (Black mini 3 | 2 | 1)

#70700 (Bezel only)

#### SKU (Silver mini 3 | 2 | 1)

#70701 (Bezel only)

#### SKU (White mini 3 | 2 | 1)

#70702 (Bezel only)

### PoE Splitter

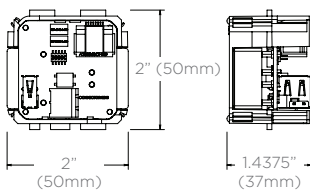

#### Dimensions

Weight: 0.14 lbs  
Height: 2"  
Width: 2"  
Depth: 1.4375"

#### Power

- Input: IEEE 802.3af
- Output: USB 5V up to 12W
- AUX Input: 18V to 24V

SKU - #70718

### PoE Injector

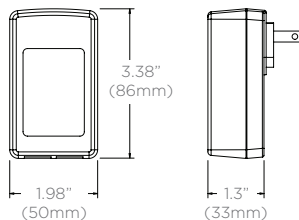

#### Dimensions

Weight: (Injector only)  
0.21 lbs  
Height: 3.38"  
Width: 1.98"  
Depth: 1.3"

#### Power

- Input: AC110-240V ~50/60Hz 0.5A
- Output: PoE IEEE 802.3af

SKU - #70719

