

BASS AMPLIFIER

Hartke Systems

*2000/3500*

Introduction 3

Features 4

Guided Tour 5

Model 2000 Front Panel 5

Model 2000 Rear Panel 7

Model 3500 Front Panel 9

Model 3500 Rear Panel 11

Setting Up and Using the Model 2000/3500 13

About Equalization 15

About Compression 17

Appendix A: Impedance vs. Expected Power 18

Appendix B: Block Diagram 19

Appendix C:

Changing the Model 2000/3500 Voltage 20

Specifications 21

---

# Introduction

Congratulations on purchasing the Hartke Systems Model 2000/3500 Bass Amplifier! Although these units are designed for easy operation, we suggest you first take some time to go through these pages so you can fully understand how we've implemented a number of unique features.

The two models covered by this manual differ in the following ways:

- The Model 2000 provides 200 watts of power (into 4 ohms), while the Model 3500 provides 350 watts of power (into 4 ohms).
- The Model 3500 offers a number of additional advanced features, including front-panel compression and graphic equalizer LED indicators, effects send and return jacks, an effects send/return balance knob, and a direct output with ground lift and pre or post EQ selection.

Both models are optimized for use with electric bass instruments, and the front panel controls in both models are virtually identical. You'll find either to be an excellent bass amplifier for live performance use in small and medium-size venues; in addition, the Model 3500's advanced features makes it ideal for use in recording environments.

In these pages, you'll find a detailed description of the many features of the Model 2000/3500 Bass Amplifiers, as well as a guided tour through their front and rear panels, step-by-step instructions for setting up and using each product, detailed discussions about equalization and compression, and full specifications. You'll also find a warranty card enclosed—please don't forget to fill it out and mail it so that you can receive online technical support and so we can send you updated information about these and other Hartke and Samson products in the future.

**SPECIAL NOTE:** Should your unit ever require servicing, a *Return Authorization* number (RA) is necessary. Without this number, the unit will not be accepted. Please call Samson Technologies at (516) 932-1062 for a Return Authorization number prior to shipping your unit. Please retain the original packing material and, if possible, return the unit in its original carton and packing materials.

The Hartke Systems Model 2000/3500 Bass Amplifiers offer all the newest concepts in bass amplification. Here are some of their main features:

- Power to spare—in the case of the Model 2000, 200 watts into 4 ohms, and, in the case of the Model 3500, a full 350 watts into 4 ohms.
- Our unique Transient Attack® circuitry which ensures that every nuance of your bass performance is reproduced faithfully.
- Two Pre-Amp input knobs, allowing custom blending of tube and solid state sounds.
- Ten bands of high-quality graphic equalization, allowing you to create a broad range of tonal colors for your bass instrument. A dedicated in/out button allows you to preset an equalization curve.
- Two fully adjustable contour knobs (high pass and low pass), which provide further control over shaping your bass sound.
- A built-in compressor which not only adds real “punch” to your bass sound, but also allows you to smooth out volume differences between notes.
- Two independent inputs that accommodate both passive and active bass guitars.
- Protection relay circuitry that protects connected speakers from dangerous overloading and also prevents “thumps” when powering on or off.
- Effect loop send and return jacks that allow you to connect to professional outboard effects processors.
- In the Model 3500, an effect Balance knob which enables you to adjust the relative amount of Send (“dry”) versus Return (“wet”) effect signal being routed to the speaker outputs.
- In the Model 3500, an electronically balanced direct output that provides a means of routing signal to professional mixing consoles in both live performance and recording environments. A ground loop switch helps prevent hum or buzz from entering the signal, and a pre/post switch allows the direct signal to be derived either before or after the amp EQ section.
- In the Model 3500, LEDs that show you the settings of the graphic equalizer in low-light environments as well as a two-color LED that continuously shows the status of the compression circuitry in response to your playing.
- In the Model 2000, a high pass filter on/off switch that enables connected speakers to be protected from subsonic frequency input.
- Rugged construction makes both the Model 2000 and Model 3500 eminently road-worthy.

# Guided Tour - Model 2000 Front Panel

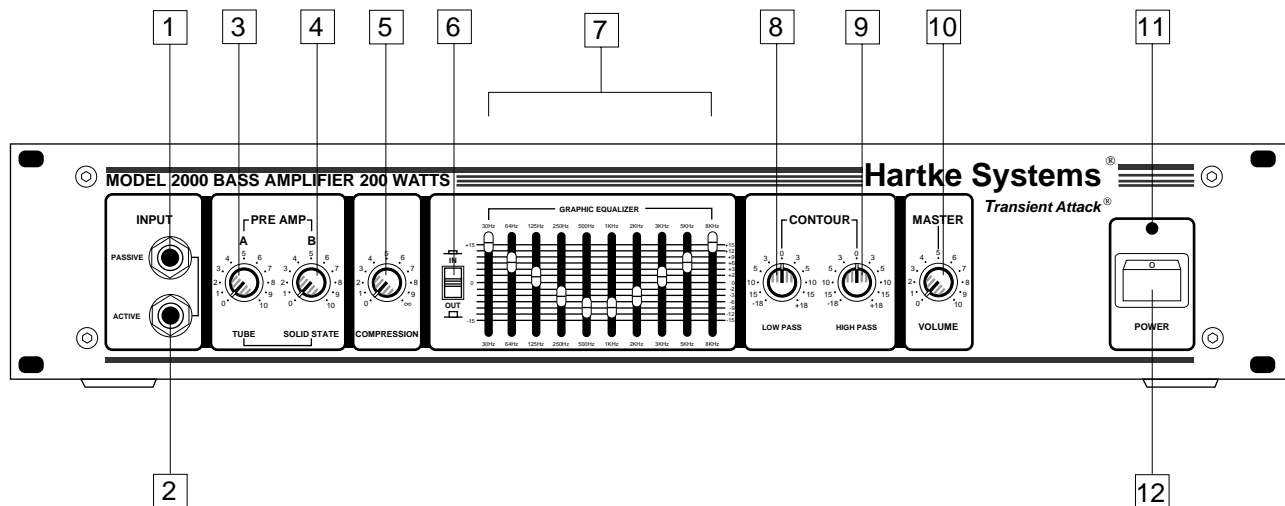

**1. Passive Input jack** - If your bass guitar has passive circuitry, connect it to the Model 2000 here. This standard 1/4" unbalanced jack provides a high impedance (100 k Ohms) input sensitivity of 20 millivolts.

**2. Active Input jack** - If your bass guitar has active circuitry,\* connect it to the Model 2000 here. This standard 1/4" unbalanced jack provides a high impedance (100 k Ohms) input sensitivity of 60 millivolts.

**3. Pre-Amp A (Tube) control** - This determines the amount of preamplification being provided by special circuitry which simulates the sound of a classic tube amplifier (this circuitry actually includes a real tube!). Note that when both Pre-Amp knobs are used at equal settings, the amplifier will be twice as loud as when only one is used. Avoid setting both Pre-Amp knobs on maximum ("10"), since the result will almost always be undesirable distortion.

**4. Pre-Amp B (Solid State) control** - This determines the amount of preamplification being provided by special circuitry which simulates the sound of a solid state amplifier. Note that when both Pre-Amp knobs are used at equal settings, the amplifier will be twice as loud as when only one is used. Avoid setting both Pre-Amp knobs on maximum ("10"), since the result will almost always be undesirable distortion.

\* Bass guitars that have active circuitry normally require a battery for the circuitry to be functional.

---

# Guided Tour - Model 2000 Front Panel

**5. Compression control** - This determines the amount of compression (peak signal reduction) by simultaneously adjusting both threshold and compression ratio (which ranges from 2:1 to infinity [limiting]). At the fully counterclockwise "Off" position, the circuitry is bypassed and no compression is applied (the knob clicks when set to the "Off" position). As the knob is raised clockwise (at settings from "1" to "∞") increasing amounts of compression are applied. For more information, see the "About Compression" section on page 15 of this manual.

**6. Graphic Equalizer In/Out switch** - When pressed in (the "In" position), the Model 2000's graphic equalizer circuitry (as described in #7 below) is operational. When pressed out (the "Out" position), it is bypassed. The provision of this switch allows you to set up a custom equalization curve (an equalization "preset") with the graphic EQ sliders, which can then be activated with the press of a single button.

**7. Graphic Equalizer** - These sliders allow you to "draw" the tonal response of the system by adding 15 dB of boost or attenuation to ten different narrow-band frequency areas (30 Hz, 64 Hz, 125 Hz, 250 Hz, 500 Hz, 1 kHz, 2 kHz, 3 kHz, 5 kHz, and 8 kHz), affecting the main output signal of the Model 2000. When a slider is at its center detented ("0") position, the selected frequency area is unaffected (it is said to be *flat*). When a slider is moved up (above the "0" position, towards the "+15" position), the selected frequency area is boosted, and when it is moved down (below the "0" position, towards the "-15" position), the selected frequency area is attenuated. For more information, see the "About Equalization" section on pages 13 - 14 of this manual.

**8. Contour Low Pass control** - This acts as a broad-band low frequency equalizer, providing 18 dB of boost or attenuation at 100 Hz. You should generally adjust this control (and the Contour High Pass control, described in #9 below) prior to "fine-tuning" the system with the graphic equalizer (as described in #7 above). For more information, see the "About Equalization" section on pages 13 - 14 of this manual.

**9. Contour High Pass control** - This acts as a broad-band high frequency equalizer, providing 18 dB of boost or attenuation at 10 kHz. You should generally adjust this control (and the Contour Low Pass control, described in #8 above) prior to "fine-tuning" the system with the graphic equalizer (as described in #7 above). For more information, see the "About Equalization" section on pages 13 - 14 of this manual.

**10. Master Volume control** - This is the overall volume control. For best signal-to-noise ratio, keep the output of your bass at or near maximum and adjust the amp's Master Volume to the desired level.

**11. Power LED** - Lights whenever the Model 2000 is powered on.

**12. Power switch** - Use this to power the Model 2000 on or off.

# Guided Tour - Model 2000 Rear Panel

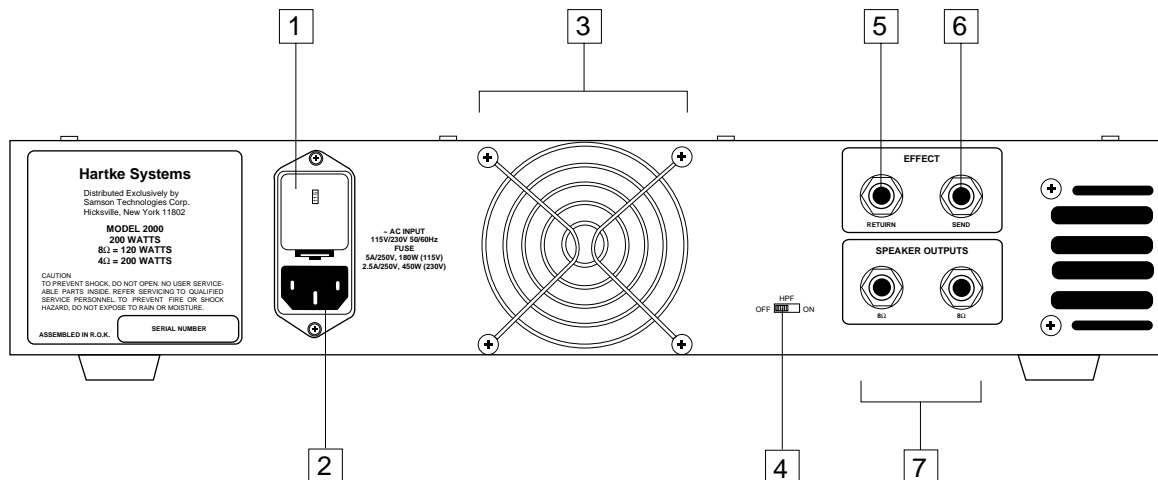

**1. Fuse sled** - This contains a fuse holder and shows the currently selected voltage rating for your Model 2000. **Make sure the voltage rating is correctly set before powering up the amplifier!** Fuse ratings are 5 amp for 115 VAC and 2.5 amp for 230 VAC. For information on how to change the voltage rating, see Appendix C on page 18.

**2. AC input** - Connect the supplied standard 3-pin “EEC” plug here.

**3. Fan** - The fan provides vital cooling to your Model 2000. Make sure that it is kept free of all obstructions and that cool, fresh air is accessible at all times. Also, try to ensure that the Model 2000 is used in a dust-free environment.

**4. HPF Off/On switch** - When on, the very lowest (subsonic) frequencies output by your Model 2000 are filtered (removed), providing protection to connected speakers. As a result, speaker movement (excursion) will be reduced, thus significantly extending the life of your speakers.

**We recommend that you keep the HPF Off/On switch at the “On” position at all times unless you are specifically using the Model 2000 with speakers specifically designed for ultra-low frequency reproduction (i.e. subwoofers). Speaker damage (to Hartke transducers) will not be covered by warranty if it is determined to have been caused by over-excursion.**

---

# Guided Tour - Model 2000 Rear Panel

**5. Effect Return jack** - Use this 1/4" unbalanced jack to return low impedance (600 ohm) signal to the Model 2000 from a professional outboard effects processor such as a reverb, echo, chorus, flanger, or harmonizer device.\*

**6. Effect Send jack** - Use this 1/4" unbalanced jack to send low impedance (600 ohm) signal from the Model 2000 to a professional outboard effects processor such as a reverb, echo, chorus, flanger, or harmonizer device.\* Output level is approximately 0 dB to +4 dB and is post-EQ and post-compression but unaffected by the setting of the Master Volume control. You can also use the Effect Send jack to route signal to an external mixing console or amplifier with an input sensitivity of +4 dB.

**7. Speaker outputs** - Connect any 4, 8, or 16 ohm bass cabinet(s) to these standard unbalanced 1/4" jacks. **WARNING: Because of the high power levels and low frequency content of the signal generated by the Model 2000, use only appropriately rated speaker cabinets (at least 250 watts at 4 ohms) that are specifically designed for bass instruments.** We recommend that Hartke amplifiers be used with Hartke bass cabinets, although other brands of speakers can be used.

*\* In-line effects (such as footpedals) intended for low signal levels should be placed between the bass and the amplifier Input and not connected with the Effect Send and Return jacks.*



# Guided Tour - Model 3500 Front Panel

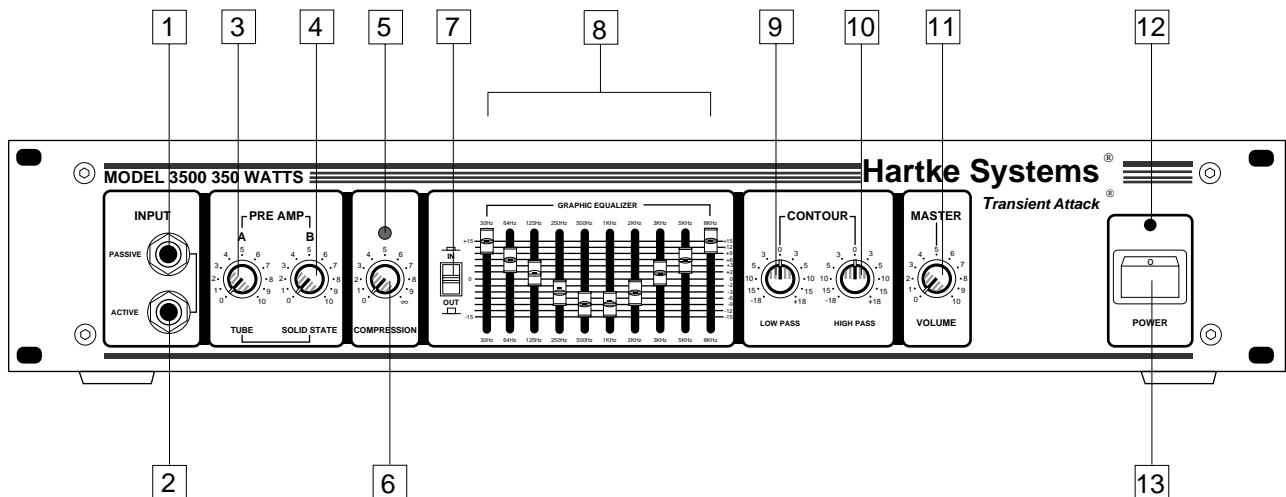

**1. Passive Input jack** - If your bass guitar has passive circuitry, connect it to the Model 3500 here. This standard 1/4" unbalanced jack provides a high impedance (100 k Ohms) input sensitivity of 20 millivolts.

**2. Active Input jack** - If your bass guitar has active circuitry,\* connect it to the Model 3500 here. This standard 1/4" unbalanced jack provides a high impedance (100 k Ohms) input sensitivity of 60 millivolts.

**3. Pre-Amp A (Tube) control** - This determines the amount of preamplification being provided by special circuitry which simulates the sound of a classic tube amplifier (this circuitry actually includes a real tube!). Note that when both Pre-Amp knobs are used at equal settings, the amplifier will be twice as loud as when only one is used. Avoid setting both Pre-Amp knobs on maximum ("10"), since the result will almost always be undesirable distortion.

**4. Pre-Amp B (Solid State) control** - This determines the amount of preamplification being provided by special circuitry which simulates the sound of a solid state amplifier. Note that when both Pre-Amp knobs are used at equal settings, the amplifier will be twice as loud as when only one is used. Avoid setting both Pre-Amp knobs on maximum ("10"), since the result will almost always be undesirable distortion.

**5. Compression LED** - Provides a visual indicator of the status of the compression circuitry. When lit steadily green (for example, when the Compression knob [see #6 on the next page] is set to "Off"), no compression is being applied. When unlit, compression is being applied to the incoming signal at a ratio of approximately 2:1. When flashing red, the compression ratio is approaching infinity (limiting is being applied to peak signals). When lit steadily red, the entire signal is being limited. This LED "follows" the incoming signal, changing continuously as different amounts of compression and/or limiting are being applied. For more information, see the "About Compression" section on page 15 of this manual.

\* *Bass guitars that have active circuitry normally require a battery for the circuitry to be functional.*

---

# Guided Tour - Model 3500 Front Panel

**6. Compression control** - This determines the amount of compression (peak signal reduction) by simultaneously adjusting both threshold and compression ratio (which ranges from 2:1 to infinity [limiting]). At the fully counterclockwise "Off" position, the circuitry is bypassed and no compression is applied (the knob clicks when set to the "Off" position). As the knob is raised clockwise (at settings from "1" to "∞") increasing amounts of compression are applied. For more information, see the "About Compression" section on page 15 of this manual.

**7. Graphic Equalizer In/Out switch** - When pressed in (the "In" position), the Model 3500's graphic equalizer circuitry (as described in #8 below) is operational. When pressed out (the "Out" position), it is bypassed. The provision of this switch allows you to set up a custom equalization curve (an equalization "preset") with the graphic EQ sliders, which can then be activated with the press of a single button.

**8. Graphic Equalizer** - These sliders allow you to "draw" the tonal response of the system by adding 15 dB of boost or attenuation to ten different narrow-band frequency areas (30 Hz, 64 Hz, 125 Hz, 250 Hz, 500 Hz, 1 kHz, 2 kHz, 3 kHz, 5 kHz, and 8 kHz), affecting the main output signal of the Model 3500. When a slider is at its center detented ("0") position, the selected frequency area is unaffected (it is said to be *flat*). When a slider is moved up (above the "0" position, towards the "+15" position), the selected frequency area is boosted, and when it is moved down (below the "0" position, towards the "-15" position), the selected frequency area is attenuated. For more information, see the "About Equalization" section on pages 13 - 14 of this manual.

**9. Contour Low Pass control** - This acts as a broad-band low frequency equalizer, providing 18 dB of boost or attenuation at 100 Hz. You should generally adjust this control (and the Contour High Pass control, described in #10 below) prior to "fine-tuning" the system with the graphic equalizer (as described in #8 above). For more information, see the "About Equalization" section on pages 13 - 14 of this manual.

**10. Contour High Pass control** - This acts as a broad-band high frequency equalizer, providing 18 dB of boost or attenuation at 10 kHz. You should generally adjust this control (and the Contour Low Pass control, described in #9 above) prior to "fine-tuning" the system with the graphic equalizer (as described in #8 above). For more information, see the "About Equalization" section on pages 13 - 14 of this manual.

**11. Master Volume control** - This is the overall volume control. For best signal-to-noise ratio, keep the output of your bass at or near maximum and adjust the amp's Master Volume to the desired level.

**12. Power LED** - Lights whenever the Model 3500 is powered on.

**13. Power switch** - Use this to power the Model 3500 on or off.

# Guided Tour - Model 3500 Rear Panel

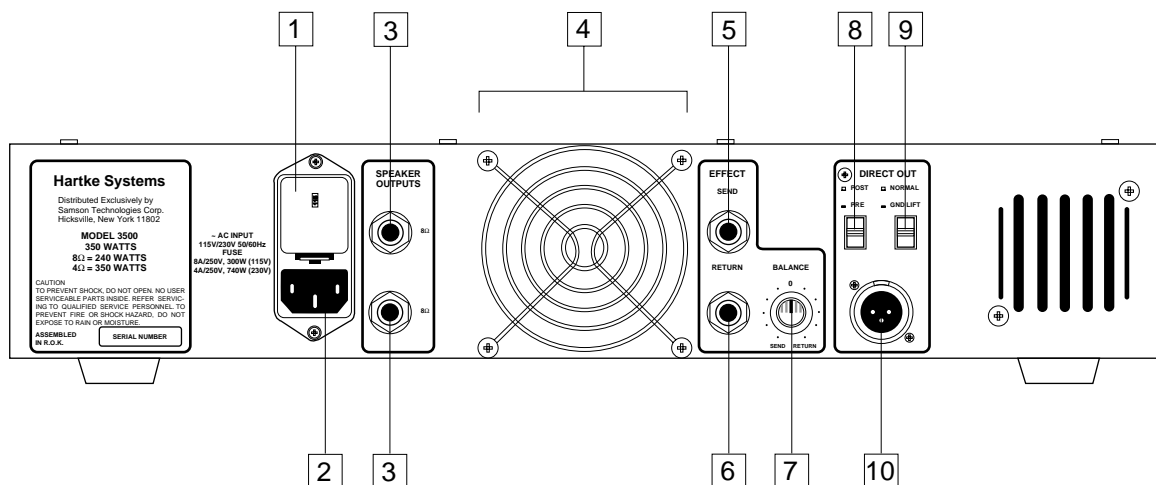

**1. Fuse sled** - This contains a fuse holder and shows the currently selected voltage rating for your Model 3500. **Make sure the voltage rating is correctly set before powering up the amplifier!** Fuse ratings are 8 amp for 115 vac and 4 amp for 230 vac. For information on how to change the voltage rating, see Appendix C on page 18.

**2. AC input** - Connect the supplied standard 3-pin "EEC" plug here.

**3. Speaker outputs** - Connect any 4, 8, or 16 ohm bass cabinet(s) to these standard unbalanced 1/4" jacks. **WARNING: Because of the high power levels and low frequency content of the signal generated by the Model 3500, use only appropriately rated speaker cabinets (at least 400 watts at 4 ohms) that are specifically designed for bass instruments.** We recommend that Hartke amplifiers be used with Hartke bass cabinets, although other brands of speakers can be used.

**4. Fan** - The fan provides vital cooling to your Model 3500. Make sure that it is kept free of all obstructions and that cool, fresh air is accessible at all times. Also, try to ensure that the Model 3500 is used in a dust-free environment.

---

# Guided Tour - Model 3500 Rear Panel

**5. Effect Send jack** - Use this 1/4" unbalanced jack to send low impedance (600 ohm) signal from the Model 3500 to a professional outboard effects processor such as a reverb, echo, chorus, flanger, or harmonizer device.\* Output level is approximately 0 dB to +4 dB and is post-EQ and post-compression but unaffected by the setting of the Master Volume control. You can also use the Effect Send jack to route signal to an external mixing console or amplifier with an input sensitivity of +4 dB.

**6. Effect Return jack** - Use this 1/4" unbalanced jack to return low impedance (600 ohm) signal to the Model 3500 from a professional outboard effects processor.\*

**7. Balance control** - Use this to adjust the relative amount of Effect Send (dry) versus Effect Return (wet) signal being routed to the Model 3500 speaker outputs. At the center-detented "0" position, equal amounts of Send and Return signal are routed. At its fully counterclockwise ("Send") position, no signal from a connected effects processor(s) is added to the main output. At its fully clockwise ("Return") position, the only signal you hear is that coming from a connected outboard effects processor(s). If your outboard effects processor has an adjustable wet/dry control, we recommend that you set the Balance knob to its fully clockwise ("Return") position and use the effects processor's wet/dry control to adjust the relative mix. Alternatively, you can set the effects processor to output fully "wet" signal and use the Model 3500 Balance knob to adjust the relative mix of dry vs. wet signal

**8. Direct Out Post/Pre switch** - When pressed in (the "Pre" position), signal is routed to the Direct Out jack prior to the Model 3500 ten-band graphic equalizer (but after the compression circuitry and Contour controls). When out (the "Post" position), signal is routed to the Direct Out jack after all compression and EQ circuitry (both ten-band graphic and Contour).\*\* Use the "Pre" position when you want the console engineer to have control over equalizing your bass signal; use the "Post" position when you want to use the front panel ten-band graphic equalizer to equalize your bass signal before sending it to the console.

**9. Direct Out Normal/Ground Lift switch** - When pressed in (the "Gnd. Lift" position), pin 1 is removed from the chassis. This should be used only when a ground loop hum or buzz is heard; otherwise, leave it in the out ("Normal") position.

**10. Direct Out jack** - Use this electronically balanced XLR jack to route signal from the Model 3500 to a professional mixing console or as a tap to a main PA system via a mic input on the console. The signal output from this jack is low impedance (600 ohm) with an output level of approximately -30 to -20 dB. You can also use the Direct Out jack to route signal to an external amplifier with a -10 dB input sensitivity.

*\* In-line effects (such as footpedals) intended for low signal levels should be placed between the bass and the amplifier Input and not connected with the Effect Send and Return jacks.*

*\*\* Note that the settings of the ten-band graphic equalizer will affect a "Post" Direct Out signal regardless of the position of the front panel In/Out switch.*

# Setting Up and Using the Model 2000/3500

Setting up your Hartke Systems 2000/3500 Bass Amplifier is a simple procedure which takes only a few minutes:

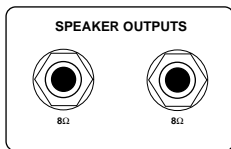
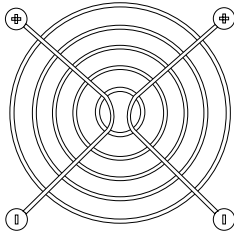

1. Remove all packing materials (save them in case of need for future service) and decide where the amplifier is to be physically placed. To avoid potential overheating problems, be sure that the rear panel is unobstructed and that there is good ventilation around the entire unit, particularly behind the rear-panel fan.

2. Begin by hooking up your bass cabinet or cabinets, using the 1/4" unbalanced Speaker output connectors on the rear panel; it is never a good idea to power up any amplifier that is not connected to loudspeakers. We recommend the use of a single 4 ohm cabinet or two 8 ohm cabinets. Hartke amps are optimized for use with Hartke bass cabinets, although other brands of speakers can be substituted. Any appropriately rated bass cabinet with a minimum impedance of 4 ohms (that is, 4 ohms or greater) can be used. In order to ensure correct phase correlation, the tip of the Model 2000/3500 speaker jack should be connected to the "+" (hot) input of your loudspeaker, and the sleeve of the Model 2000/3500 speaker jack should be connected to the "-" (ground) input of your loudspeaker.

**WARNING: Hartke amplifiers can deliver very high power levels. Driven to full power, they can damage connected loudspeakers, regardless of brand, size, or configuration. Care should be taken not to strain connected loudspeakers as this can cause permanent damage and will degrade the performance of the entire system. If you see connected loudspeakers moving excessively, turn your system down immediately or use the equalization and/or compression controls to reduce the amount of subharmonic (extremely low frequency) signal.**

3. Next, connect the 3-pin AC plug into any grounded AC socket. Don't turn the amplifier on just yet, though.

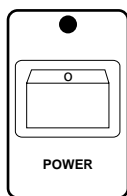
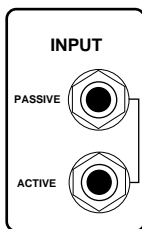

4. Use a standard music instrument cable to connect your bass to the appropriate Input jack on the front panel (if your bass has active circuitry,\* connect it to the "Active" input; if not, connect it to the "Passive" input). On the front panel of the Model 2000/3500, set the Master volume control to "0" (fully counterclockwise) and set both Pre-Amp A (Tube) and B (Solid State) knobs to "5" (the twelve o'clock position). Set the Compression knob to its "Off" position (fully counterclockwise—you'll hear a click) and set both Contour knobs to their center detented "0" position. Finally, set the graphic equalizer In/Out switch to its "Out" position.

5. Press the front panel Power switch in order to turn on the amplifier. After approximately three seconds, you'll hear a click, indicating that the relay protection circuitry has completed cycling and that power to the system has been provided.

6. Set the output of your bass to maximum and then, while playing, slowly turn the Master volume control up until the desired level is achieved. If you hear distortion even at low amplifier Master volume settings, back off the output of your bass (or check for a faulty cable).

\* Bass guitars that have active circuitry normally require a battery for the circuitry to be functional.

# Setting Up and Using The Model 2000/3500

7. Experiment with altering the balance of the two Pre-Amp knobs, listening to the effect each has on the overall sound. Depending upon the specific instrument you are using and your personal taste, you may prefer the sound of one over the other, or you may prefer a particular blend of the two. Note that, when both are used at equal settings, the amplifier will be twice as loud as when only one is used. In step #4 on the previous page, we recommended that you begin with both knobs at their midway “5” setting, but the two Pre-Amp knobs can in fact be set to any blend you like. However, you will usually want to avoid setting both to their maximum “10” position since this setting will almost always result in undesirable distortion.

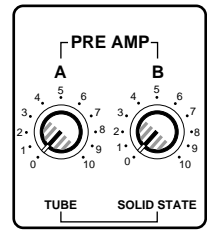

8. When you have settled on a Pre-Amp balance, the next step is to adjust the two Contour (bass and treble equalizer) controls to taste. For more information, see the “About Equalization” section on page 13 of this manual. When you get a great setting that complements your instrument and playing style, it’s a good idea to write it down for future use.

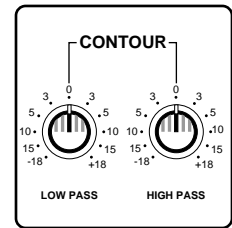

9. Next, experiment with the Model 2000/3500 graphic equalizer. Begin by setting each of the ten sliders to their flat “0” center detented position. Then press in the In/Out switch (to its “In” position) so that the graphic equalizer is activated. Finally, move each slider in turn as you play your bass. For more information, see the “About Equalization” section on page 13 of this manual. Again, when you get a graphic equalization setting that complements your instrument and playing style, it’s a good idea to write it down for future use.

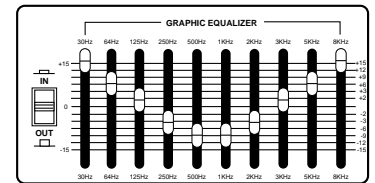

10. Now try out the Model 2000/3500 compression circuitry. Activate it by turning the Compression knob clockwise from its “Off” position (you’ll hear a click when it is activated). As you turn the knob clockwise, the input signal from your bass becomes more and more severely compressed—you’ll hear peak signals (such as string slaps and pulls) begin to sound increasingly “squashed,” relative to the lower-level signals produced by standard playing. The result will be a decreased dynamic range but an overall leveling of signal throughout the full pitch range of your instrument. For more information, see the “About Compression” section on page 15. In the Model 3500, the Compression LED will light steadily green when no compression is being applied, will go out whenever small amounts of compression are being applied and will flash or light steadily red when limiting (severe compression) is being applied.

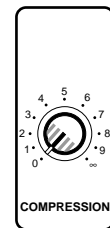

11. If you’re using an external signal processor, turn your Hartke amplifier off momentarily and then connect a standard audio cable between the Effect Send jack and your effects processor input and another standard audio cable between the Effect Return jack and your effects processor output (if required, multiple effects processors can be daisy-chained together, output to input). If you are using a Hartke 3500, start with the effect Balance knob at its center detented “0” position, so that you hear equal amounts of both the send and return signal.\* Then turn the amp back on and play your bass while adjusting the controls of your outboard effects processor(s). For best results, set both the input and output gain of all connected effects processor(s) to 0 dB (unity gain), so that there is no increase or decrease in level whether the effects are switched in or out.

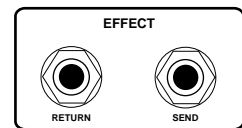

Model 2000 Effect Send/Return jacks

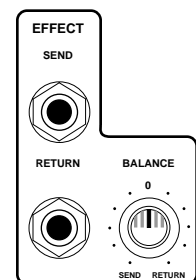

Model 3500 Effect Send/Return jacks and Balance control

If you have followed all the steps above and are still experiencing difficulties, call Samson Technical Support (516-932-1062) between 9 AM and 5 PM EST.

\* For more information on the use of the Hartke 3500 effect Balance control, see page 10 in this manual.

# About Equalization

The Hartke Systems Model 2000/3500 Bass Amplifier gives you enormous control over shaping the sound of your bass, using a process called *equalization*. To understand how this works, it's important to know that every naturally occurring sound consists of a broad range of pitches, or *frequencies*, combined together in a unique way. This blend is what gives every sound its distinctive tonal color. EQ controls allow you to alter a sound by boosting or attenuating specific frequency areas—they operate much like the bass and treble controls on your hi-fi amp, but with much greater precision. The Model 2000/3500 provides you with two different means for equalizing your bass sound:

- Low Pass and High Pass Contour controls provide 18 dB of cut or boost in two broad frequency bands.
- A Graphic Equalizer provides 15 dB of cut or boost in ten narrow frequency bands.

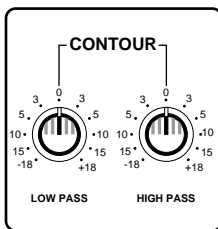

Contour controls

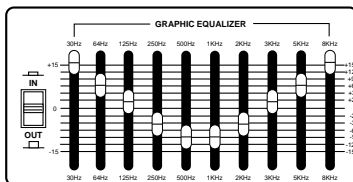

Graphic equalizer

Normally, you will adjust the two Contour controls before “fine-tuning” your EQ with the Graphic Equalizer. The Low Pass Contour control affects a broad band of frequencies with 100 Hz as the center point; similarly, the High Pass Contour control affects a broad band of frequencies with 10 kHz as the center point. When either is in its center detented position (“0”), it is having no effect. When it is moved right of center, the particular frequency area is being boosted; when it is moved left of center, the frequency area is being cut (“attenuated”). Because there is very little bass guitar energy at 10 kHz, the High Pass Contour control should be thought of as your overall “noise” control—turning it down (to the left of the “0” position) will help to eradicate hiss and buzz while having very little effect on the bass guitar signal. Similarly, the Low Pass Contour control, when set left of 0, can be used to eliminate rumble and “woofiness.”

The ten-band graphic equalizer provides ten sliders, each corresponding to a single narrow frequency band (at 30 Hz, 64 Hz, 125 Hz, 250 Hz, 500 Hz, 1 kHz, 2 kHz, 3 kHz, 5 kHz, and 8 kHz). This allows you to “draw” the desired tonal response of your system. When a slider is in its center detented position (“0”), it is having no effect. When it is moved above center (towards “+15”), the particular frequency area is being boosted; when it is moved below center (towards “-15”), the frequency area is being attenuated. We carefully selected these frequency areas because they have maximum impact on bass signals. For example, the lowest slider (30 Hz) affects the very lowest audible frequencies (in fact, most humans cannot hear below 20 Hz), while the highest four sliders (2, 3, 5, and 8 kHz) affects the “twang” of a bass string.

**WARNING: Use caution when raising the 30 Hz slider above 0 if you are operating at high volume levels (especially if Compression is not being used) since this can place undue stress on connected loudspeakers.**

# About Equalization

To find out how each graphic equalizer slider affects the sound of your particular bass, start with all ten bands flat (that is, all ten sliders at their detented “0” center position). Then, one by one, raise and lower each slider, listening carefully to the effect of each. If you don’t specifically need to utilize the ten-band graphic equalizer, bypass it by setting the In/Out switch to its “Out” position. Alternatively, you can preset a custom graphic equalization curve (for example, for a feature solo) and activate it simply by pressing the switch when needed. Note that turning all EQ controls up the same amount will have virtually the same effect as simply turning up the Master Volume; conversely, turning them all down the same amount will have virtually the same effect as turning down the Master Volume. Both approaches are pointless (after all, that’s why we gave you a Master Volume control!)

In many instances, the best way to deal with equalization is to think in terms of which frequency areas you need to attenuate, as opposed to which ones you need to boost. Be aware that boosting a frequency area also has the effect of boosting the overall signal; specifically, too much low frequency EQ boost can actually cause overload distortion or even harm a connected speaker, though the Model 2000/3500’s compression circuitry—if on—will act to some extent to prevent this from occurring. In general, if you’re going to apply a fair amount of low frequency EQ boost, it’s a good idea to keep Compression on, if only to protect your speakers from potential damage.

The specific EQ you will apply to your bass signal is very much dependent upon your particular instrument and personal taste and playing style. However, here are a few general suggestions:

- For that super-deep reggae or Motown sound, boost low frequencies slightly while attenuating the highest ones (leave mid-range frequencies flat or slightly attenuated), as shown in the illustration on the right.
- To remove boxiness and make your instrument sound more “hi-fi,” try attenuating mid-range frequencies while leaving low and high frequency settings flat, as shown in the illustration on the right.
- For a twangy, cutting sound, try boosting the high and high mid-range frequencies, as shown in the illustration on the right (putting new roundwound strings on your bass will help a lot also!)
- Whenever you get a really good EQ setting for a particular instrument or song, write it down (you’d be amazed how easy it is to forget these things!).

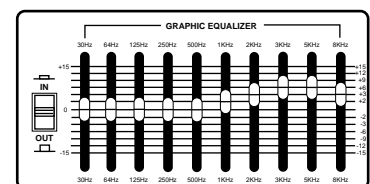
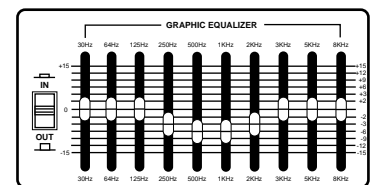
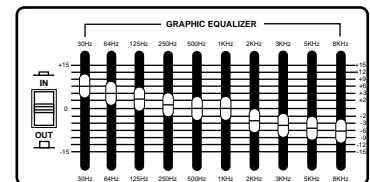

Finally, as you experiment with the EQ controls of the Model 2000/3500, don’t forget that your bass also provides EQ controls in the form of its tonal settings—this can be particularly effective in instruments that have active circuitry. Also, try various EQ settings with different Pre-Amp blends and with and without Compression. For more information, see the “About Compression” section on the following page.



---

# About Compression

The *dynamic range* of a sound is the difference between its loudest and softest points. For example, as you play your bass, you'll probably find that some notes (for example, notes played on the upper frets of the lowest string) are considerably louder than others. The function of the Compression circuitry in the Model 2000/3500 Bass Amplifier is to reduce overall dynamic range by automatically reducing the level of the loudest sounds you play so that they are closer in level to softer ones—the end result is that the sound “evens out” and all notes played have pretty much the same level.

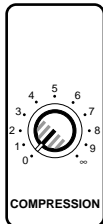

Model 2000  
Compression control

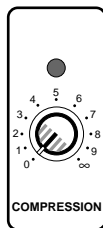

Model 3500  
Compression control  
and LED

The front-panel Compression control determines the amount of compression (peak signal reduction) by simultaneously adjusting both threshold and compression ratio (which ranges from 2:1 to infinity [limiting]). At the fully counter-clockwise “Off” position, the circuitry is bypassed and no compression is applied (the knob clicks when set to the “Off” position). As the knob is raised clockwise (at settings from “1” to “∞”) increasing amounts of compression is applied. At the highest settings, loud sounds will not just be compressed, but *limited*, where the output remains virtually constant regardless of input.

The Model 3500 provides a front-panel Compression LED which acts as a useful visual indicator of the continuous activity of the compression circuitry. When lit steadily green (for example, when the Compression knob is set to “Off”), no compression is being applied. When unlit, compression is being applied to the incoming signal at a ratio of approximately 2:1. When flashing red, the compression ratio is approaching infinity (limiting is being applied). When lit steadily red, the signal is being limited. This LED “follows” the incoming signal, changing continuously as different amounts of compression and/or limiting are being applied.

Compression has three main uses. First, as just described, it “evens” out the notes played by your bass so that they all appear at virtually equal level. Second, it adds “punch” to a sound; since all levels are nearly the same, you can play with greater force without worrying about the loudest notes distorting. Finally, it serves to protect your loudspeakers from damage as a result of brief (*transient*) high output levels, as might be caused by finger-popping or other performance techniques.

Whether or not you need to use compression with your Model 2000/3500 will be a matter of personal taste and playing style—experiment and see if you like the effect. If you usually play at low volume levels, you’ll find that, even with the Compression knob turned up, the compression circuitry may have no audible effect, so it might as well be off. In general, if you don’t need compression, leave it off.

---

# Appendix A: Impedance vs. Expected Power

(NOTE: Measurements taken at 1 kHz, Solid State in, and at 3 kHz, Tube in, with 20 Hz - 30 kHz bandpass filter, to give less than 1% THD)

Model	Speaker Impedance	Expected Power
2000	4 ohms	200 W
2000	8 ohms	120 W
2000	16 ohms	80 W
3500	4 ohms	350 W
3500	8 ohms	240 W
3500	16 ohms	145 W

# Appendix B: Block Diagram

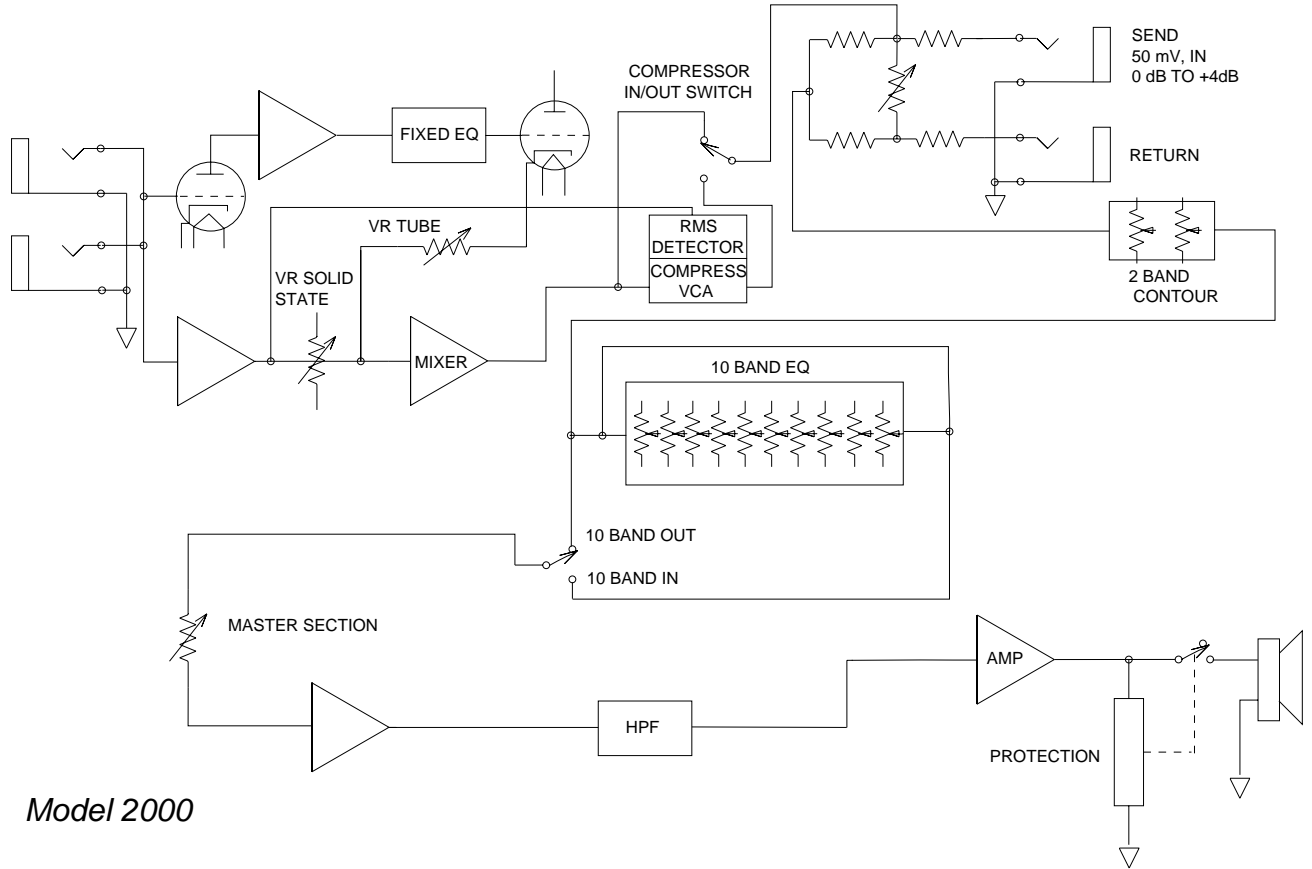

Model 2000

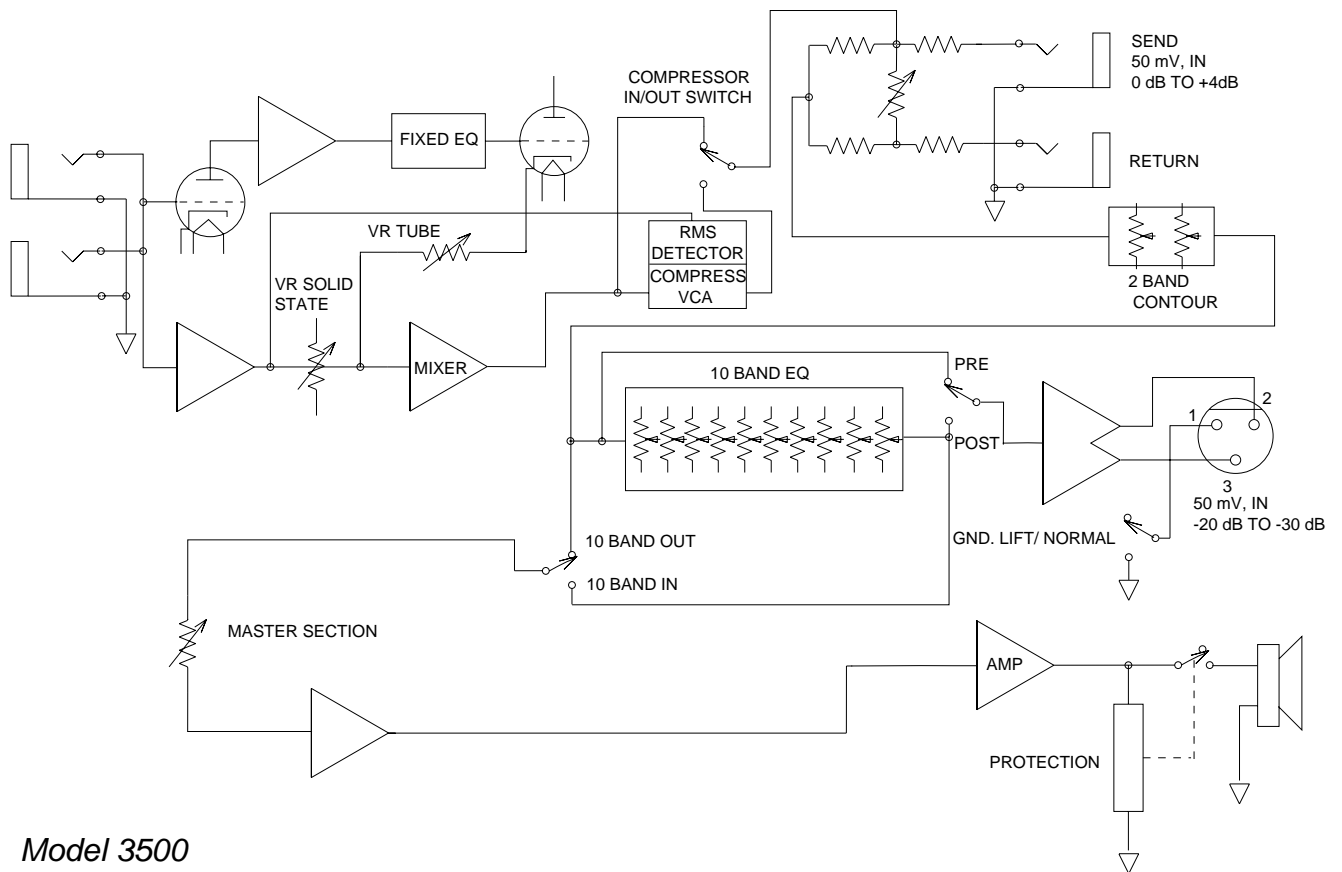

Model 3500

# Appendix C: Changing the Model 2000/3500 Voltage

Following are step-by-step instructions for changing the mains voltage of the Model 2000/3500.

**WARNING: Before carrying out this operation, remove the power cord!**

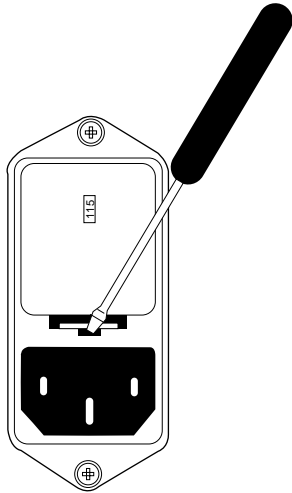

**1:** Insert a small screwdriver into the slot beneath the fuse sled and gently press in and up. The fuse sled will pop out approximately 3/8" inch.

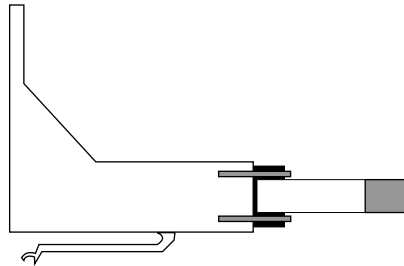

**2:** Remove fuse sled.

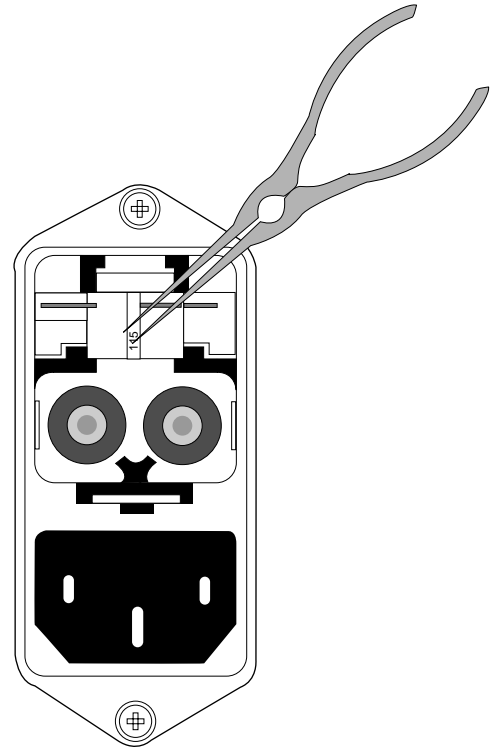

**3:** Use a small pair of needlenose pliers to gently pull out the mains jumper.

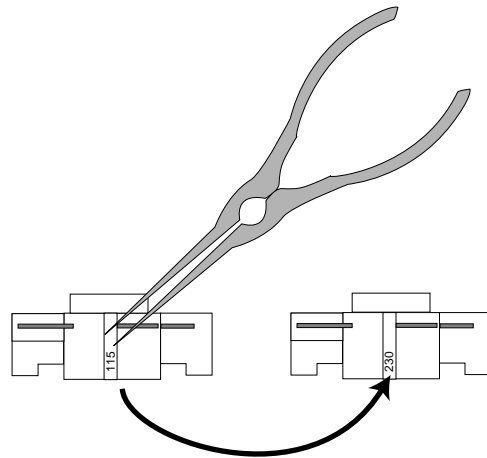
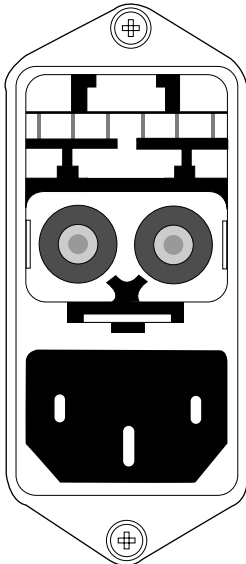

**4:** Use the needlenose pliers to reverse the mains jumper so that the other voltage value is facing outwards, then reinsert the mains jumper. Finally, reinsert the fuse sled by gently pushing it back in until you hear a click.

Note that the fuse sled carries two fuses—one for 115 volt operation (actually 105 - 120 volts) and another for 230 volt operation (actually 220 - 240 volts). **The position of the two fuses in the sled as well as the fuse ratings must be maintained for adequate protection.** Fuse ratings for the Model 2000 are: 5 amp for 115 VAC and 2.5 amp for 230 VAC. Fuse ratings for the Model 3500 are: 8 amp for 115 VAC and 4 amp for 230 VAC.

---

# Specifications

<b>1. Input Sensitivity</b>	
Passive Input	100 k Ohms 20 mv.
Active Input	100 k Ohms 60 mv.
<b>2. Rated Output Power</b>	
Model 2000	200 watts @ 4 ohms 120 watts @ 8 ohms
Model 3500	350 watts @ 4 ohms 240 watts @ 8 ohms
<b>3. Total Harmonic Distortion</b>	
Model 2000	less than 1%
Model 3500	less than .5%
<b>4. Signal To Noise Ratio</b>	
Model 2000	approx. 70 dBm
Model 3500	approx. 78 dBm
<b>6. Equalizer</b>	
Contour Low Pass	±18 dB @ 100 Hz
Contour High Pass	±18 dB @ 10 kHz
Ten-Band Graphic	±15 dB, center detented @ 30 Hz, 64 Hz, 125 Hz, 250 Hz, 500 Hz, 1 kHz, 2 kHz, 3 kHz, 5 kHz, 8 kHz
<b>7. Compression Ratio</b>	2:1 to infinity
<b>8. Send Output Level</b>	0 dBm
<b>9. Return Input Level</b>	0 dBm