



PC7 (clean – reply version)

Blue Highlight – further reply changes

Appendix 1: District Plan Administration

Purpose

This chapter contains matters necessary for administering and implementing the District Plan and Council’s assessment and determination of resource consent applications. These matters are:

- 1.1 Definitions and Terms
 - 1.1.1 Acronyms Used in the District Plan
 - 1.1.2 Definitions Used in the District Plan
- 1.2 Information Requirements
- 1.3 Assessment Criteria
 - 1.3.1 Guide to Using the Criteria
 - 1.3.2 Controlled Activities – Matters of Control
 - 1.3.3 Restricted Discretionary, Discretionary and Non-Complying Assessment Criteria
- 1.4 Design Guides

This chapter also identifies other methods of implementation (1.5) relevant to the issues raised in the District Plan.

1.1 Definitions and Terms

1.1.1 Acronyms Used in the District Plan

AEE	Assessment of Environmental Effects
CDP	Comprehensive Development Plan
cds/m ²	Candelas per square metre
CPTED	Crime Prevention through Environmental Design
FTE	Full-Time Equivalent
GFA	Gross Floor Area
GLFA	Gross Leasable Floor Area
ICMP	Integrated Catchment Management Plan
ITA	Integrated Transport Assessment
LIUDD	Low-Impact Urban Design and Development
LAP	Local Area Plan
LTP	Long-Term Plan
m ²	Square metres
m ³	Cubic metres
NIMTR	North Island Main Trunk Railway
NMP	Noise Management Plan
PFA	Public Floor Area
RPS	Regional Policy Statement
VPD	Vehicles Per Day

1.1.2 Definitions Used in the District Plan

Unless specified otherwise the definitions below apply in this District Plan. Where any term used in the District Plan is not defined below or elsewhere in the District Plan (including by reference) then the following hierarchy of definition sources applies as appropriate and relevant to the context:

- a) The Resource Management Act 1991 and its regulations.
- b) Any relevant National Policy Statement or National Environmental Standard.
- c) Any other relevant New Zealand legislation and their regulations.
- d) The Oxford Concise English Dictionary.

Accessible: Means able to be accessed by all users including those with sight and mobility impairment.

Accessibility: Means the ease with which activities, either economic or social, can be reached or accessed by people.

Accessibility modelling: Means the measurement of how easy it is for an individual to participate in desired activities, based on a set of factors, including mode and destination choice.

Accessible parking spaces: Means parking spaces designed specifically for vehicle users with mobility impairments.

Accessory building: Means a building, which is clearly incidental to the principal building or primary land use on a site. Accessory buildings include garages, carports, sleep-outs, rumpus rooms, garden sheds, and storage sheds. Such a building will not meet all of the primary living requirements of the occupants, and the occupants remain members of the principal household. An accessory building used as a sleep-out must contain no more than two bedrooms and must not contain any kitchen facilities or laundry facilities. Solar panels and solar water-heating devices not attached to a building are included in the definition of an accessory building. Accessory buildings can be either attached to or detached from another building on the site.

Access strip: Means a strip of land created by the registration of an easement in accordance with Section 237B of the Resource Management Act for the purpose of allowing public access to or along any river, or lake, or the coast, or to any esplanade reserve, esplanade strip, other reserve, or land owned by the local authority or by the Crown (but excluding all land held for a public work except that held, administered, or managed under the Conservation Act 1987 and the Acts named in the First Schedule to that Act).

Access way: As defined in s315(1) of the Local Government Act 1974.

Acoustic Design Certificate: Means a certificate provided by an acoustic engineer, architect or other person(s) experienced in the field of acoustic design.

Act: Means the Resource Management Act 1991 and any amendments.

Active frontage: Means a façade of a building that includes windows and preferably an entrance to encourage activity and allow passive surveillance of the street, carpark or area of public space.

Active modes of transport: Means those methods of transportation that involve physical effort such as walking and cycling.

Adjacent: Means lying near to, but not necessarily contiguous to.

Adjoining: Means next to and joined with or is contiguous to.

Allotment: Means:

- a) Any parcel of land under the Land Transfer Act 1952 that is a continuous area and whose boundaries are shown separately on a survey plan, whether or not:
 - i. The subdivision shown on the survey plan has been allowed, or subdivision approval has been granted by Council.
 - ii. A subdivision consent for the subdivision shown on the survey plan has been granted under the Act.
- b) Any parcel of land or building or part of a building that is shown or identified separately:
 - i. On a survey plan.
 - ii. On a licence within the meaning of Part 7A of the Land Transfer Act 1952.
- c) Any unit on a unit plan.
- d) Any parcel of land not subject to the Land Transfer Act 1952.

Alterations and additions: Means any work to existing buildings or structures which involves the addition, change, removal or replacement of walls, windows or features which results in an external appearance different to its existing appearance, but excludes activities identified in the definition for 'Minor Works (in Business 1-7, Central City, Industrial, Ruakura Logistics and Ruakura Industrial Park Zones)'. It may result in increasing or decreasing floor space through change of the external walls.

Amateur radio: Means a radio-communication service for the purpose of self-training, intercommunication and technical investigations carried out by amateurs, that is, by duly authorised persons interested in radio technique solely with a personal aim and without pecuniary interest.

Amateur radio configuration: Means the antennas, aerials (including rods, wires and tubes) and associated supporting structures which are owned and used by licensed amateur radio operators.

Amenity Protection Area: Means an area within an Industrial Zone adjacent to the boundary with residential sites or other sensitive areas. The extent of Amenity Protection Areas is indicated on the Planning Maps. Amenity Protection Areas provide greater control with respect to building height, site coverage, hazardous facilities, landscaping and screening within the Industrial area in order to minimise adverse effects on the amenity of residential sites, or other sensitive areas, adjacent to land zoned Industrial.

Amenity values: means those natural or physical qualities and characteristics of an area that contribute to people's appreciation of its pleasantness, aesthetic coherence, and cultural and recreational attributes.

Ancillary: Means an activity or structure which is subordinate or subsidiary to the principal activity on the site.

Ancillary residential structure: Means a structure associated with the day-to-day running of a household that does not meet the definition of a 'building'. This includes letterboxes, clothes lines, swimming pools and accessories, ornamental pools, fences and walls not exceeding 2.5m in height, steps, terraces and patios (not roofed or enclosed, and not exceeding 1m in height).

Ancillary residential unit: Means a self-contained residential unit held in common ownership with the primary activity on the site. To be self-contained the ancillary residential unit must have a kitchen, bathroom, bedroom(s), living room and laundry facilities. The ancillary residential unit can be attached to the principal building, or be a detached stand-alone structure. In the Industrial and Ruakura Logistics Zone it means any residential unit ancillary to any activity undertaken on site, e.g. a caretaker's residence, live-in employees or security staff accommodation.

Ancillary retailing and offices: Means any retail or office activity on the same site as the principal activity, and whose use is ancillary to that principal activity (e.g. a retail showroom attached to a manufacturing premises) and forms an integral part of the business occupying the site.

Annual Average Daily Traffic (AADT): Refer to NZS6806: 2010 Acoustics – Road traffic noise – New and altered roads.

Annual Exceedance Probability (AEP): Means the probability, expressed as a percentage, that a flood of a given magnitude will be equalled or exceeded in any one year. For example, a 1% AEP means an event that has a 1% probability of occurring or being exceeded in any one year.

Antenna (defined in the National Environmental Standard for Telecommunications Facilities 2008): Means a device that:

- a) Receives or transmits radio-communication or telecommunication signals.
- b) Is operated by a network operator.
- c) Includes the mount, if there is one, for the device.
- d) Includes the shroud, if there is one, for the device.

Any activity specified in the Hamilton City Public Places Bylaw 2009 or Public Places Policy 2009: Means outdoor dining, signs in public places, markets, stalls, merchandise displays and mobile shops, busking, hawking and charitable collection.

Apartment building: Means a residential building comprising three or more attached residential units. For the avoidance of doubt, residential units physically connected by one or more accessory buildings, such as garages, will also be deemed to be attached.

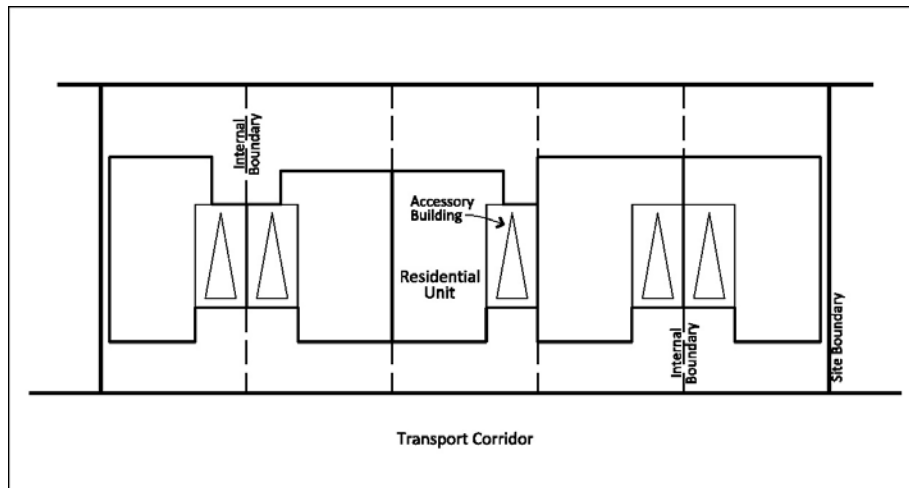

Archaeological Site (as stated in the Heritage New Zealand Pouhere Taonga Act 2014):
Means any place in New Zealand that:

- i. Was associated with human activity that occurred before 1900 or,
 - ii. Is the site of the wreck of any vessel where that wreck occurred before 1900.
- b) Is or may be able, through investigation by archaeological methods, to provide evidence relating to the history of New Zealand.

Arterial transport corridor: Means any major or minor arterial transport corridor.

Artificial watercourse: A watercourse that contains no natural portions from its confluence with a river or stream to its headwaters and includes irrigation canals, water supply races, canals for the supply of water for electricity power generation and farm drainage canals.

Assessment Period: Means the time over which traffic conditions for the expected environment should be considered as part of a simple or broad Integrated Transport Assessment as described in Appendix 15-2. This should include traffic growth, planned infrastructure and changes in nearby land use and access characteristics.

Automotive and/or marine suppliers: Means a business primarily engaged in selling automotive vehicles and/or marine craft, accessories to and parts for such vehicles and craft.

Includes:

- boats and boating accessories
- trucks, cars and motorcycles
- auto parts and accessories
- trailers and caravans
- tyres and batteries
- mobility scooters.

Average Net Site Area: means the area of the site, including any internal vehicle access or private way, but excluding any entrance strip or private way to a rear site from any transport corridor, divided by the number of residential units.

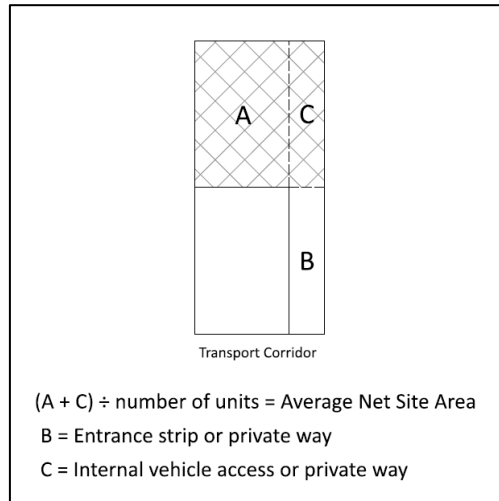

Bank: Means a financial establishment that receives money on current or deposit account, provides a transactional deposit and withdrawal service, provides credit/makes loans at interest and exchanges currency. This excludes offices of banks without a transactional service element or where such transactions are limited to electronic funds transfer at point of sale (EFTPOS machines).

- a) In relation to any river:
 - i. For the purposes of esplanade reserves, esplanade strips, and subdivision, the space of land which the waters of the river cover at its annual fullest flow without overtopping its banks.
 - ii. In all other cases, the space of land which the waters of the river cover at its fullest flow without overtopping its banks.
- b) In relation to any lake, except a lake controlled by artificial means:
 - i. For the purposes of esplanade reserves, esplanade strips, and subdivision, the space of land which the waters of the lake cover at its annual highest level without exceeding its margin.
 - ii. In all other cases, the space of land which the waters of the lake cover at its highest level without exceeding its margin.
- c) In relation to any lake controlled by artificial means, the space of land which the waters of the lake cover at its maximum permitted operating level.

Bioaccumulation: Means accumulation of a substance within the tissues of living organisms.

Block: Means accumulation of allotments bounded on all sides by public roads.

Boarding kennels and catteries: means any land, structures or buildings used for the purpose of accommodating dogs or cats on a commercial basis, but does not include the keeping of dogs or cats as an ancillary activity for domestic purposes, or the keeping of dogs to assist in the management of a farm or other rural activity.

BOD₅: Means the biochemical oxygen demand (measured at 20°C over a 5-day period), which is the amount of dissolved oxygen in a body of water required for the breakdown of organic matter in the water. When discharged to surface water or groundwater, these substances have the potential to deplete oxygen as a result of microbial decomposition of organic material (e.g. milk or other foodstuffs). In the context of a hazardous substance a high BOD₅ is >10,000 mg/l.

Boundary Adjustment: Means an alteration of boundaries between two or more allotments (whether or not the allotments are held within the same Computer Freehold Registers) which will result in each of the allotments having substantially the same boundaries, area, shape and access as before.

Buffer Strip: Means a planting strip of a permeable nature with planting consisting of shrubs which can grow to a mature growth height of at least 2 metres, planted at a maximum of 1.5 metres apart, and including at least 1 tree for every 10m of boundary length.

Building: Means any structure of any kind, whether temporary or permanent, moveable or immovable, and includes:

- a) Any fence or wall over 2.5m in height.
- b) Any retaining wall over 1.5m in height and load bearing.
- c) Any scaffolding or falsework erected temporarily for maintenance or construction purposes.
- d) Any vehicle, trailer, tent, caravan or boat, whether fixed or moveable, used as a place of accommodation, business or storage.
- e) Any swimming pool with walls more than 1.2m above the ground level at any point.
- f) Any deck more than 1m above the ground level at any point.
- g) A mast pole or a telecommunication aerial that is on, or forms part of, a building and that is more than 7m in height above the point of its attachment or base support (except a dish aerial that is less than 2m wide).

A building does not include:

- h) Except for the purposes of the Electricity Transmission Corridor Rules in Table 25.7.4:
 - (i) Pergolas, not roofed or enclosed, and not exceeding 3m in height; and
 - (ii) Lych-gates not exceeding 3m in height.
- i) Steps, terraces and patios, not roofed or enclosed, and not exceeding 1m in height.
- j) Public art, floodlights, goal posts, park furniture.

Buildings housing network utility equipment: Means structures needed for housing pumps, weather stations, recording stations, etc, containing network utility structures.

Building improvement centre: Means premises used for the storage, display and sale of goods and materials used in the construction, repair, alteration and renovation of buildings and includes nurseries and garden centres.

Building line: Refer to **building line restriction**, **front building line** or **rear building line** as relevant.

Building line restriction: Means a restriction imposed on a site to ensure that when new buildings are erected, or existing buildings re-erected, altered or substantially rebuilt, no part of any such building shall stand within the area between the building line and the adjacent site boundary.

Bulk and location provisions: Means density, site coverage, permeable surfacing, height in relation to boundary, building setback, separation, outdoor living area and service area related provisions.

Bulk power supply: Means greater than 20kW generation.

Business activities: Means activities carried out on a site principally for commercial gain.

Business activities associated with the racing industry: Means businesses which are associated with horse-racing activities, such as those undertaken at Te Rapa Racecourse. This includes administration services for the racing industry, authorised betting agencies, offices for businesses involved in bloodstock and/or breeding and/or training and/or racing of horses, businesses providing veterinary and/or research services, and retail and/or manufacturing activities which predominantly handle equine-related products.

Cabinet (defined in the National Environmental Standard for Telecommunication Facilities, 2008): Means a casing around equipment that is necessary to operate a telecommunication network.

Central City transport corridor: Means any transport corridor identified as a Central City transport corridor in Appendix 15, Figure 15-4e, the function and form of which is defined in Volume 2, Appendix 15-4.

Centre Viability Assessment Report: Means an analysis to determine whether the scale and trading format of the activity is appropriate for the location, having regard to the hierarchy of business centres, maintaining the primacy of the Central City and the opportunity for development within higher order centres.

Childcare facilities: Means premises where children are cared for or given basic tuition and includes a crèche, day or after-school care, pre-school, kindergarten, kohanga reo or play centre. This term excludes a school.

Clean fill: Includes soil, clay, sand, gravel, silt, rock and other inert materials such as broken concrete and brick, or mixtures of any of the above, but excludes materials:

- a) Containing hazardous substances.
- b) Contaminated with hazardous substances or pathogens.
- c) Derived from hazardous waste treatment, hazardous waste stabilisation or hazardous waste disposal practices.
- d) Medical and veterinary waste, asbestos, or radioactive substances that may present a risk to human health.
- e) Likely to create leachate by biological or chemical breakdown.
- f) Containing organic content of 5% or more of the total volume.
- g) Having a particle size of 200mm or more.

Clubrooms: Means premises which are set aside for the use, convenience and enjoyment of a recreational or community organisation which may be licensed under the Sale and Supply of Alcohol Act.

Collector transport corridor: Means any transport corridor identified in Appendix 15, Figure 15-4b to 15-4f as Collector or Proposed Collector, the function and form of which is defined in Appendix 15-4.

Commercial activities on the surface of water: Means any activity undertaken on the surface of water for commercial gain. This includes motorised and non-motorised commercial activities such as jet-boats, cruise boats and kayak tours.

Commercialisation of research and innovation activities (Precincts A and B – Knowledge Zone): Means activities directly related to permitted research and innovation activity including prototype development and maintenance, initial run product development, manufacturing method development and logistics method development.

Communal open space: Means a quantity of landscaped land freely available to all residents on the site, exclusive of driveways, buildings, and private outdoor space of individual residential units.

Community garden: Means a garden operated by a group or collective on public land for the purpose of growing plants, vegetables or fruit. Not for commercial gain.

Community Centre: Means premises designed to act as a meeting place for people of all ages in the local community. It provides for a range of functions such as playgroups for children, before- and after-school care, crafts, education courses/seminars, spiritual, cultural, recreational, health and wellbeing purposes. It also acts as a base for social support and possibly delivers some social services. They can also include ancillary offices, temporary fundraising activities and one small retail activity for the purpose of providing fundraising or a social service (such as an opportunity shop). Such centres are owned/administered by local or central government authorities, and voluntary /charitable organisations providing voluntary/not-for-profit services.

Community scale energy generation (produces less than 20kW): Means renewable energy generation for the purpose of using electricity on a particular site, supplying an immediate community, or connecting into the distribution network (but excludes solar panels supplying electricity for the site on which they are located).

Company lease: Has the same meaning as the Act.

Conference facilities: Includes seminar rooms.

Construction work: Means any work in connection with the construction, erection, installation, carrying out, repair, maintenance, cleaning, painting, renewal, removal, alteration, dismantling, or demolition of:

- a) Any building, erection, edifice, structure, wall, fence or chimney, whether constructed wholly or partly above or below ground level.
- b) Any road, motorway, harbour or foreshore works, railway, cableway, tramway, canal, or aerodrome.
- c) Any drainage, irrigation, or river control work.
- d) Any electricity, water, wastewater, stormwater, gas, or telecommunications reticulation.

- e) Any bridge, viaduct, dam, reservoir, earthworks, pipeline, aqueduct, culvert, drive, shaft, tunnel, or reclamation.
- f) Any scaffolding.

Construction work includes:

- a) Any work in connection with any excavation, site preparation, or preparatory work, carried out for the purpose of any construction work.
- b) The use of any plant, tools, gear or materials for the purpose of any construction work.
- c) Any construction work carried out underwater, including work on ships, wrecks, buoys, rafts, and obstructions to navigation.
- d) Any inspection or other work carried out for the purpose of ascertaining whether construction work should be carried out.

Construction noise: Means noise arising from any construction work, as defined above.

Contaminated land: Has the same meaning as the Act.

Council: Means the Hamilton City Council and includes any committee, subcommittee or person acting under delegated authority.

CPTED: Means Crime Prevention Through Environmental Design, a crime-prevention philosophy based on the premise that

“proper design and effective use of the physical environment can produce behavioural effects that will reduce the incidence and fear of crime, thereby improving the quality of life. These behavioural effects can be accomplished by reducing the propensity of the physical environment to support criminal behaviour”

(Crowe, 1991, *Crime Prevention Through Environmental Design: Applications of Architectural Design and Space Management Concepts.*)

Note

Further guidance in relation to CPTED principles can be obtained within the Ministry for Environment’s CPTED guidelines.

Cross lease: Has the same meaning as the Act.

Culvert Block Flood Hazard Area: Means that part of any land affected by flooding as a consequence of a blocked culvert downstream. This is the maximum extent of flooding before water overtops the accessway or transport corridor above the culvert (refer to the Planning Maps).

Cumulative risk: Means the risk posed by a Hazardous Facility added to or multiplied, or otherwise cumulated by risks from other facilities.

Customary activities: As described in Schedule 3 of Waikato-Tainui Raupatu Claims (Waikato River) Settlement Act 2010 and includes cultural harvest as defined in Section 63(9) of the Waikato-Tainui Raupatu Claims (Waikato River) Settlement Act 2010.

Dairy: Means the use of a building in a residential area for the sale of day-to-day food and associated household items. The majority of its trade must be derived from the sale of milk, bread, non-alcoholic beverages and other day-to-day convenience merchandise. Retail activity involving food cooked on the premises and the sale of alcohol are excluded.

Demolition or removal of buildings: Means dismantling, destruction and/or removal of part or all of any building.

Design Speed Environment: Means the maximum speed of vehicles created by traffic management and the design of transport corridors. These speeds reflect the desirable maximum speeds given the land use environment and transport corridor hierarchy. Refer to Appendix 15-6 for further detail.

Design year (Chapter 25.8: City-wide – Noise and Vibration): Refer to NZS6806: 2010 Acoustics – Road traffic noise – New and altered roads.

Development: Means any activity undertaken to change the scale, character or intensity of any use of land, and includes any building activity.

Development Agreement: Means a binding contract between Council, other infrastructure providers and developers for the funding of additional infrastructure and the use and upgrading of existing infrastructure.

Dish: Means an antenna with which signals are transmitted to, or received from, a communications satellite. This applies to dishes attached to a building, as well as those mounted on their own support structure.

Dispensing facility: Means for drive-through fast food or service outlets each single combination of an order point, a payment point, and a collection point and for service stations a single petrol pump or a group of petrol pumps that are grouped on a single 'island'.

Disposal: Means discharge of a hazardous substance into the environment, with or without biological or chemical treatment that may change composition and characteristics of the substance.

Drive-through services (excluding service stations within the Rototuna Town Centre Zone): Means any premises where goods and services are offered for sale to the motoring public, primarily in a manner where the customer can remain in their vehicle. Drive-through services can include dispensing and associated storage of motor fuels (as the primary activity) and the sale of associated goods, services, food and beverages, fast-food outlets providing on-demand meals prepared on the premises for consumption therein or take away, the provision of servicing and running repairs for light motor vehicles and any other activity of a drive-through nature, including those ancillary to the above.

Duplex dwelling: Means a residential building comprising two attached residential units on one allotment, or two Computer Freehold Registers where subsequently subdivided in reliance on rule 23.7b)ii). For the avoidance of doubt, residential units physically connected by one or more accessory buildings, such as garages, will also be deemed to be attached.

For the purpose of this definition 'allotment' shall have the same meaning as 'Computer Freehold Register' as such term is defined in the Land Transfer Act 2017, and may comprise more than one freehold register where held together by a registered legal instrument.

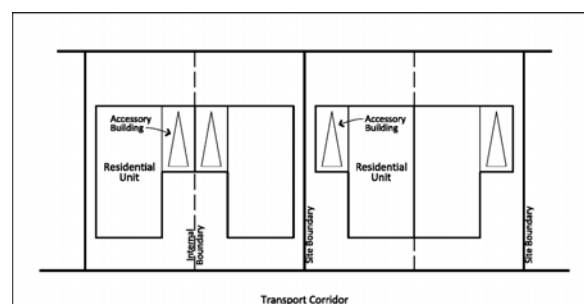

Earthquake strengthening: Means specific seismic structural works undertaken to strengthen buildings or structures.

Earthworks: Means the disturbance of the land surface by moving, removing, placing or replacing soil or earth, by excavation, cutting or filling, but excludes cultivation of land and foundation piling.

Eave: Means that portion of the roof extending beyond the exterior wall of a building, having a maximum overhang of 1.0m.

Ecological corridors: Means natural corridors that provide for the movement of flora and fauna for a variety of purposes, including feeding and breeding.

Eco-sourced: Means plants which are grown from seeds or propagules collected from naturally occurring vegetation in a locality close to where they are replanted as part of a restoration or re-vegetation project.

Ecosystem: Means any system of interacting terrestrial or aquatic organisms within their natural and physical environment.

Ecosystem services: Means the benefits people obtain from ecosystems. These include provisioning services such as food and water; regulating services such as flood and disease control; cultural services such as spiritual, recreational, and cultural benefits; and supporting services such as nutrient cycling that maintain the conditions for life on Earth.

Edge of the bank: Means the topographical feature defined in the diagram below:

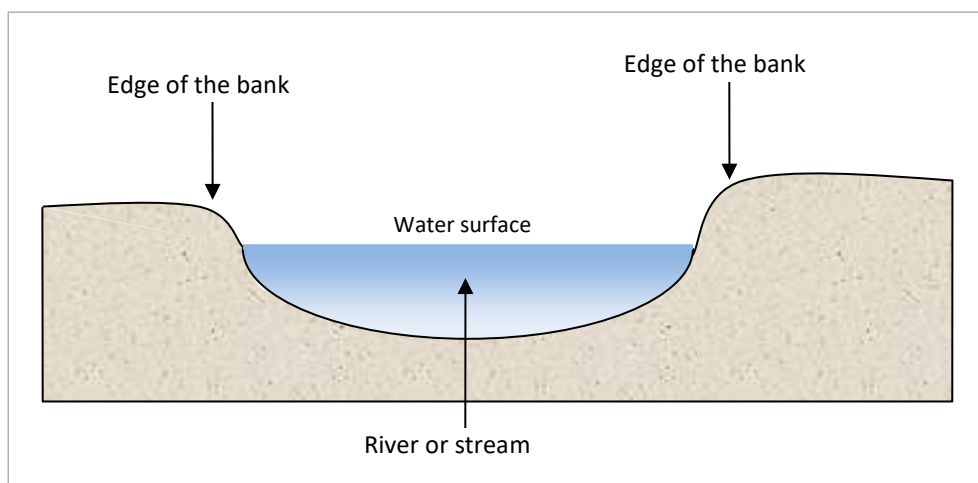

Effect: Means:

- a) Any positive or adverse effect.
- b) Any temporary or permanent effect.
- c) Any past, present or future effect.
- d) Any cumulative effect which arises over time or in combination with other effects regardless of the scale, intensity, duration, or frequency of the effect, and also includes:
 - i. Any potential effect of high probability.
 - ii. Any potential effect of low probability which has a high potential impact.

Electricity distribution: Means the lines (above and below ground) and structures involved in the final stage of delivery of electricity to end users. A distribution system's network conveys electricity from the transmission network and delivers it to consumers. Typically, the network would include low, medium and high-voltage (less than 110 kV) electric lines, substations, switching stations and road side transformers, ring main units and pillar boxes.

Electricity transmission network, electricity transmission and transmission activities/assets/infrastructure/resources/system: All mean part of the national grid of transmission lines and cables (aerial, underground and undersea, including the high-voltage direct current link), stations and sub-stations and other works used to connect grid injection points and grid exit points to convey electricity throughout the North and South Islands of New Zealand. This is owned and operated by Transpower NZ Limited.

Electronic Sign: Means a form of illuminant advertising media that are created solely from a light source and include digital screens, cinema projections, LED signs and the like.

Emergency housing: Means any Managed Care Facility in which temporary residential accommodation, care and/or support are provided by another person or agency for five or more residents (including children) on an emergency basis or for their personal protection. For the purpose of calculating the number of residents, account shall be taken of owners and/or staff and any of their children aged 16 years or older who live on the premises. Including, but not limited to night shelters and women's refuges.

Emergency service facilities: Means those facilities of organisations which are responsible for the safety and physical welfare of people or property in the community, and includes fire, ambulance and police stations.

Entertainment and recreation facility: Means land or buildings which are used principally for the public or private assembly of persons for cultural, entertainment, recreation, leisure, education or similar purposes. They include gymnasiums, public halls, theatres and cinemas, display galleries and museums, bowling alleys.

Entrance strip: Means that part of a rear site extending from the street frontage, which has a width less than or equal to the minimum subdivision frontage standard required for a rear lot in the zone, and accommodates the driveway for that site.

Environment: Means:

- a) Ecosystems and their constituent parts, including people and communities.
- b) All natural and physical resources.
- c) Amenity values.
- d) The social, economic, aesthetic and cultural conditions which affect the matters stated in a) to c) of this definition or which are affected by those matters.

Environmental maintenance: Means the routine care and attention of the transport corridor to maintain safety, aesthetic and environmental standards, including:

- a) Clearing the carriageway of damaged vehicles, crash debris and spills.
- b) Maintenance of planting, including pruning.
- c) Control of weeds and pest plants.
- d) Mowing of the grass berm.

- e) Removal of litter.
- f) Removal of rocks and slip material from the transport corridor or catch fences.
- g) Removal of, and protection against, graffiti.
- h) Snow clearing and ice control.
- i) Sweeping loose chip and detritus.

Equestrian supply retail: Means a business selling equipment including horse floats, feed, supplements, clothing and accessories related to the equine industry.

Event: Means an activity that is irregular or infrequent and does not require the construction of a permanent building, the installation of permanent infrastructure or services, or works such as vegetation clearing or other operational work. Events involve large groups of people either as participants or spectators and include carnivals, parades, concerts, markets, craft or trade fairs, field days, open days, displays and the like. This definition applies only where the activity is **not** covered by another definition/activity in the District Plan.

Excavation, modification and disturbance: Means to dig into the soil, or the removal of soil or other material from the ground; or the movement of soil or other material on to or within the site which changes the existing profile of the landform; with the exception of those matters defined as minor work.

Exotic vegetation or trees: Means vegetation or trees which do not occur naturally in New Zealand (refer also to the definition of **indigenous vegetation**).

Expected outcome: Means in relation to any rule the environmental outcome expected from compliance with that rule.

Expressway: Means a road mainly for through traffic, usually a dual carriageway with full or partial control of access. Intersections are generally grade separated.

External Outlook Area: Means an area of open space visible from the window of an indoor living area which remains unobstructed by buildings or other structures.

Fabric: Means all the physical material of a building, object, site, place or area that contributes to its character.

Farming: Means a land-based activity having as its primary purpose the commercial production of any livestock or vegetative matter, and includes bee-keeping, horse training agistment, but excludes forestry and intensive farming.

Fence: Means any structure, intended to be a permanent division, screen or barrier, but shall not include a post-wire fence or temporary fence.

Flammable: Means having the capability to be ignited in the presence of oxygen and to sustain combustion. Refer Hazardous Substances and New Organisms Act 1996 Regulations.

Flood Hazard Area: Means the land shown on the Planning Maps as:

- a) High Flood Hazard Area.
- b) Medium Flood Hazard Area.
- c) Low Flood Hazard Area.
- d) Temple View Flood Hazard Area.

e) Culvert Block Flood Hazard Area.

Flood protection structure: Means physical structures for the purpose of flood protection, such as dams, stop-banks and flood gates.

Floor Area (for residential units in the Residential Intensification zone, Medium Density Residential zone, Central City zone and Business zones): Means that total square metres (m²) of the floor space of each residential unit when measured from the outer edge of the unit's exterior walls, including from the mid-point of the inter-tenancy walls shared with adjoining units. But excludes garages, carports and other accessory buildings associated with the residential unit; and communal spaces such as pedestrian access, stairwells or service areas within the building.

Floor area ratio: Means the ratio between the gross floor area of a building and the net area of the site which for the purposes of this definition comprises one or more lots in permanent contiguous ownership and occupied exclusively by the development to which the requirement applies.

Food and beverage outlets: Means premises serving food and/or beverages prepared for immediate consumption on or off the premises to the general public. It includes bakeries, lunch bars and cafes operating during normal working hours, but excludes restaurants, licensed premises, and supermarkets.

Forestry: Means the establishment (including replanting) and management of forest or tree plantations for commercial gain but does not include saw-milling or other timber processing. Includes pruning and thinning (manual operations done from the ground). Does not include Christmas tree farms.

Formal recreation: Means sports fields, greens, courts.

Frangible: Means able to be broken and absorb enough impact energy to reduce the severity of a vehicle collision. Non-hardwood species of trees with a diameter of less than 100mm when measured 400mm above the ground are considered to be frangible.

Note

Guidance for frangible species can be found in Appendix 1 of 'Guidelines for Highway Landscaping' December 2006, Transit New Zealand.

Front building line: Means a line or lines drawn across the site creating a space forward of the façade of any buildings facing an adjoining transport corridor.

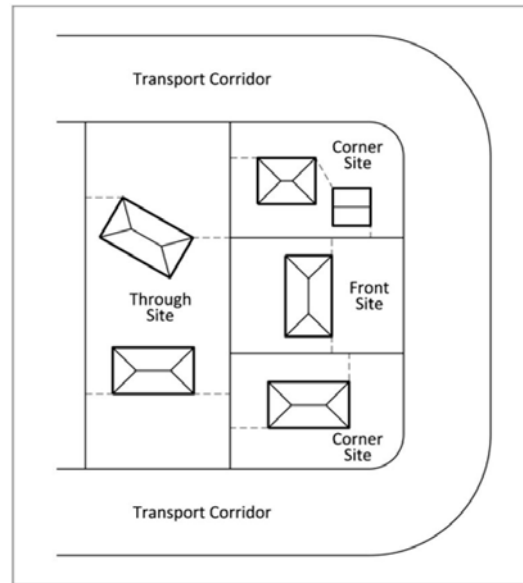

Frontage: Means that portion of the boundary of any lot which is also the boundary of an existing road, or road to be vested or otherwise legalised as a condition of subdivision consent. For the purpose of this definition, 'road' does not include any service lane or accessway.

Fronting: Means a site having legal and or physical frontage or access to a road.

Full Integrated Catchment Management Plan: Means an Integrated Catchment Management Plan for a full hydrological catchment that has been technically certified by the Waikato Regional Council (with regard to compliance with Council's Comprehensive Sortmwater Discharge Consent) and Council.

General recreation: Means any active sports or games or recreational pursuits for participants and/or spectators and the fields necessary to accommodate them but excludes motorised vehicle sports.

Greenfield development: means subdivision and/or urban development of previously undeveloped rural land.

Green corridors: Means a strip of land, the majority of which is vegetated and which may include surface water, and its associated airspace, which afford access and connectivity for pedestrians, cyclists or wildlife. Green corridors are often, but not necessarily, along the route of a transport corridor, a natural or artificial waterway or a network utility and may include an underpass or an overpass. These corridors may serve several functions simultaneously, including amenity, recreation, transportation, drainage, ecological, biodiversity and network utility functions. Green corridors could comprise privately or publicly owned land.

Greenwood/Kahikatea Corridor: Means those lots shown in Volume 2, Appendix 6, Figure 6-5.

Gross Floor Area (GFA): Means the sum of the gross floor area of all floors of all buildings on a site measured from the exterior faces of the exterior walls or from the centrelines of walls separating two buildings. Gross floor area shall:

- a) Include elevator shafts, stairwells and lobbies at each floor and mezzanine floors and balconies.
- b) Exclude any provided car-parking, loading and servicing areas and access thereto and building service rooms containing equipment such as lift machinery, tanks, air conditioning and heating plants.

Gross Leasable Floor Area (GLFA): Means the sum of any floor areas (within the external walls of buildings) designed for tenant occupancy and exclusive use including both freehold and leased areas. It includes any stock storage or preparation areas whether exclusive or not, but excludes the following areas where these are common and not designed for rental: liftwells and stair wells including landing areas; corridors and malls; building service rooms; required parking areas.

Ground level: See **natural ground level**.

Gymnasium: Means a facility that provides for physical exercise or activity and includes, but is not limited to, weight lifting studios, group exercise spaces, indoor sport facilities, yoga, pilates and dance studios and indoor physical recreational activities such as trampoline parks and climbing facilities.

Habitable floor area (natural hazards): Means that part of any building used for residential activities but excludes floorspace used solely for the purposes of an entrance, passageway, toilet, bathroom, laundry, garage or storeroom.

Habitable room: Means any room that is part of a building used for any noise sensitive activity, apart from those rooms used solely for the purposes of an entrance, passageway, toilet, bathroom, laundry, garage or storeroom.

Harvesting forestry: Means the felling and extracting of trees, processing them into logs and then loading on to trucks. Does not include Christmas tree farms.

Hazard: Means physical situations, processes and actions that have the potential for adverse effects on people, property or the natural environment.

Hazard Area: Means the land shown on the Planning Maps as:

- a) High Flood Hazard Area.
- b) Medium Flood Hazard Area.
- c) Low Flood Hazard Area.
- d) Temple View Flood Hazard Area.
- e) Culvert Block Flood Hazard Area.
- f) Waikato Riverbank and Gully Hazard Area.

Hazardous facility: Means any activity involving hazardous substances and sites at which these substances are stored, used, transported or disposed of, and any installations or vehicles parked on site that contain hazardous substances. A Hazardous Facility does not include:

- a) Wastewater networks, or waste treatment and disposal facilities (this exception does not apply to the storage of hazardous substances or waste associated with these facilities).
- b) The incidental use and storage of hazardous substances in minimal domestic quantities.

-
- c) LPG installations using one or more cylinders as part of a piped system for domestic heating and cooking purposes that:
 - i. Have a maximum capacity of 100kg, and
 - ii Are limited to one per household
 - d) Retail outlets for the sale of hazardous substances for domestic use (e.g. supermarkets, hardware shops, pharmacies, home garden centres) .
 - e) Facilities using genetically modified or new organisms.
 - f) Facilities presenting a dust explosion risk of non-hazardous substances.
 - g) Gas or oil pipelines, including all incidental equipment.
 - h) Fuel contained in tanks of motor vehicles, agricultural and forestry equipment, boats, aircraft and small engines.
 - i) Developments that are or may be hazardous but do not involve hazardous substances (e.g. radio masts, electrical substations).
 - j) The occasional loading and unloading of hazardous substances on a site where this forms only a minor part of site operations.
 - k) Routine, renewal and new works to a transport corridor and transport infrastructure including related storage, all within road reserves.

Note

The above activities must comply with any relevant Hazardous Substances and New Organisms Act 1996 or regulation requirements to be excluded from the definition of a Hazardous Facility.

Hazardous substance: Means any substance:

- a) With one or more of the following intrinsic properties:
 - i. Explosiveness.
 - ii. Flammability.
 - iii. A capacity to oxidise.
 - iv. Corrosiveness.
 - v. Toxicity (including chronic toxicity).
 - vi. Ecotoxicity, with or without bioaccumulation.

Or

- b) Which on contact with air or water (other than air or water where the temperature or pressure has been artificially increased or decreased) generates a substance with any one or more of the properties specified in paragraph (a).

Or

- c) Containing radioactive material.

Or

- d) That in water has a high BOD₅ (>10,000 mg/l)

Health care services: Means services relating to physical and mental health and welfare, performed by duly qualified practitioners or by persons in their employ and includes services provided by medical practitioners or by persons in their employ including

surgical procedures and day-patient care, dentists and veterinary surgeons but excludes a **hospital**.

Height (in relation to maximum height of a building): Means the vertical distance between:

- a) A horizontal plane through the highest point of the roof, excluding service rooms containing equipment such as lift machinery, tanks, air-conditioning and heating plants, aerials and dishes as permitted in Volume 1, Chapter 25.7 City-wide – Network Utilities and the Electricity National Grid Corridor; and chimneys, flues and similar projections of less than 1m² in area and projecting not more than 2m above maximum permitted height.
- b) A horizontal plane through the mean of the highest and lowest point of the natural ground level along the relevant external wall of the building provided that any calculated mean height shall not exceed the maximum permitted height.

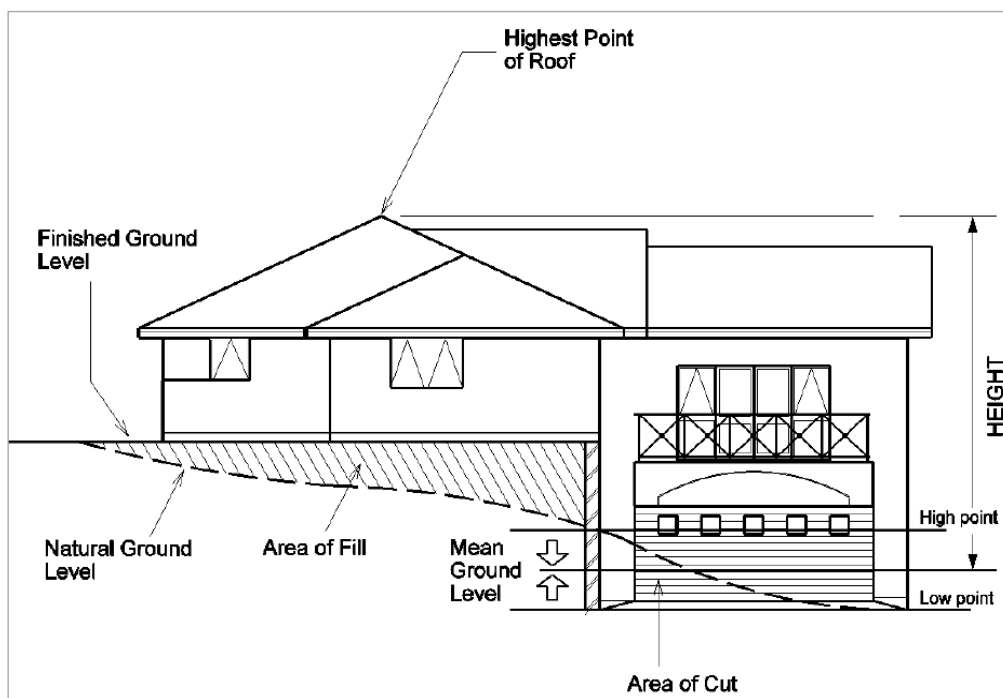

Height control plane: Means a surface through which no part of a building other than chimneys, flues and similar projections not exceeding 2m in height and 1m² in area or an aerial as permitted in Volume 1, Chapter 25.7 City-wide – Network Utilities and the Electricity National Grid Corridor may protrude. It is defined by drawing height control lines from all points on the boundaries of an allotment or unit site area. Such lines are to start at a specified vertical distance above the natural ground level at the boundary, point into the site at right angles to the boundary and rise at a specified angle.

HEIGHT CONTROL PLANE

The height in relation to boundaries of the allotment or unit site area shall vary with the direction or bearing of each allotment or unit boundary according to the diagrams below.

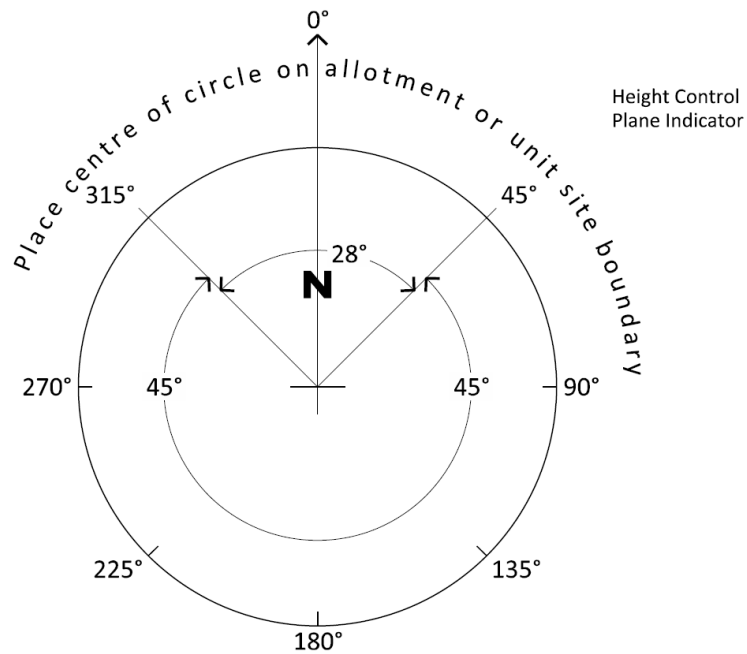

NOTE: North is True North

The height control plane shall be calculated by orientating both the site plan and height control plane indicator to true north, and placing the height control plane indicator over the site plan with the centre of the circle touching the allotment or unit site boundary under consideration. The height control plane angle shall be that indicated by that sector of the diagram within which a line drawn at right angles to the allotment or unit site boundary from the centre of the circle lies.

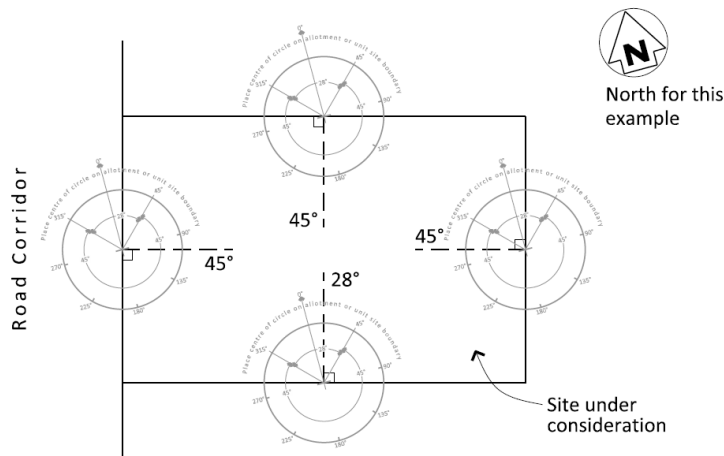

Heritage item: Means a building, structure, object, site or place and all elements of that item, which have been identified as having heritage value.

High BOD₅: See BOD₅.

High Flood Hazard Area: Means that part of any land predicted to be affected by river or surface flooding during a 1% annual exceedance probability event. Further detail for how this Flood Hazard Area category has been derived is contained in Appendix 11. High Flood Hazard Areas are identified on the Planning Maps.

High-intensity sign: Means any flashing, moving or animated sign, or any other active sign including electronic signs.

High-use allocation: Means industrial activities requiring more than 15m³ of water per day excluding:

- a) Water used for human drinking and sanitation.
- b) The volume of water discharged into the municipal wastewater system.

Hire centre: Means premises that hire tools and equipment, including machinery and equipment for event purposes such as utensils, marquees and safety equipment. It does not include the hiring of personal electronic equipment such as video games, computer consoles, video library premises, or the hire of indoor or outdoor recreational equipment.

Home-based business: Means an occupation, craft or profession which is incidental to the residential use of the site, where the principal operator of the home business is a permanent resident on the site. A home-based business excludes: activities involving heavy vehicles, panel beating, spray painting, motor vehicle repairs, motor vehicle dismantling, motor body building, servicing of internal combustion engines, fibreglassing, sheet metal work, wrought iron work or manufacture, bottle or scrap metal storage, rubbish collection, establishments for boarding domestic pets, funeral parlours, and the sale/trading of motor vehicles. The owner or occupier of a household unit is not precluded from carrying out normal maintenance and repair of domestic equipment including vehicles owned by the household owner/occupier.

Homestay accommodation: Means a portion of a dwelling occupied on a temporary (periods of up to 3 months continuous occupation during any 12-month period) basis and includes bed and breakfast establishments. The maximum occupancy is six guests at any one time.

Household: means a person or a group of people related or unrelated who reside together and interact on a daily basis to maintain a self-contained housekeeping unit. This definition excludes people living in residential centres or managed care facilities.

Hospital: Means an institution providing primarily in-patient care for the sick or injured, including medical, surgical, maternity, mental health, convalescent or hospice care, and includes all hospital clinics, dispensaries, out-patient departments, operations and maintenance support services (such as laundries, kitchens, cafeterias, refreshment facilities, residential centres, generators, substation, storage facilities and workshops), hospital administration offices, ancillary retail facilities and undertakings maintained in connection with, or incidental to, the hospital activity.

Impermeable surfaces: Means surfaces such as roads, roof tops, footpaths, paving, decking which does not allow water to drain through to a surface which can absorb water, swimming pools, patios or highly compacted soil that are not vegetated and do not infiltrate run-off.

Incidental: Means accompanying as a minor part to something else.

Indigenous vegetation or trees: Means vegetation or trees that occur naturally in New Zealand or arrived in New Zealand without human assistance.

Indoor Living Area: Means the area comprising of kitchen, dining and/or lounge areas.

Indoor recreation: Means recreational activities within a building. Includes courts, swimming pools and gyms, with ancillary facilities such as changing rooms.

Industrial activity: includes:

- a) All types of processing, manufacturing, service and repair activities
- b) Laboratories and research facilities
- c) Transport depots.

Informal recreation: Means an activity whose aim is the enjoyment of leisure of a primarily non-competitive casual nature and includes resting, sitting, walking, cycling, jogging, enjoying nature, picnicking, barbecuing, spontaneous informal games and kite flying.

Infrastructure: Means:

- a) pipelines that distribute or transmit natural or manufactured gas, petroleum, biofuel, or geothermal energy;
- b) a network for the purpose of telecommunication as defined in section 5 of the Telecommunications Act 2001;
- c) a network for the purpose of radiocommunication as defined in section 2(1) of the Radiocommunications Act 1989;
- d) facilities for the generation of electricity, lines used or intended to be used to convey electricity, and support structures for lines used or intended to be used to convey electricity, excluding facilities, lines, and support structures if a person -
 - i. uses them in connection with the generation of electricity for the person's use; and
 - ii. does not use them to generate any electricity for supply to any other person;
- e) a water supply distribution system, including a system for irrigation;
- f) a drainage or sewerage system;
- g) structures for transport on land by cycleways, rail, roads, walkways, or any other means;
- h) facilities for the loading or unloading of cargo or passengers transported on land by any means;
- i) an airport as defined in section 2 of the Airport Authorities Act 1966;
- j) a navigation installation as defined in section 2 of the Civil Aviation Act 1990;
- k) facilities for the loading or unloading of cargo or passengers carried by sea, including a port related commercial undertaking as defined in section 2(1) of the Port Companies Act 1988;
- l) anything described as a network utility operation in regulations made for the purposes of the definition of network utility operator in section 166.

Integrated Catchment Management Plans: Means a full Integrated Catchment Management Plan (ICMP) or sub-catchment ICMP being an analysis of the effects of development on all three waters infrastructure capacity and the appropriateness and

integrity of proposed treatments and reticulation systems as described in Appendix 1.2.2.6.

Integrated Residential Development: Means a development containing a mixture of residential units, and specifically more than one of the following types: single dwellings, duplex dwellings and/or apartment buildings on a site which is designed in a comprehensive way. The development may include shared facilities such as open space, access, parking and manoeuvring, and may have other communal activities (e.g. recreational facilities, office administration) for the exclusive use of the residents of the development and their visitors.

The development may include where relevant management structures which govern its day to day operation (such as for retirement villages or rest homes).

An integrated residential development does not include a development that consists solely of one of the following activities:

- One type of residential unit
- Hospitals
- Managed Care Facilities
- Residential Centres.

Integrated retail development: Means a development of retail activities on a site which are managed as a comprehensive entity, and which has combined facilities (i.e. service areas, loading spaces and parking) which are accessible from, and can be used by, all the individual tenancies of the development.

Integrated Transport Assessment: Means an analysis to determine impacts of a development on the transport network for all modes of travel and effects on safety, parking, efficiency, access and the capacity of the transport network. This District Plan identifies two levels of assessment, simple and broad; the content of these is detailed in Appendix 15-2.

Intensive farming: Means the commercial raising and keeping of plants or animals, which is dependent on a high input of food or fertiliser, is not dependent on the soil characteristics of the site, and is contained in buildings or outdoor enclosures. This includes, but is not limited to, poultry farms, piggeries and mushroom farms.

Interface area: Means land within the Major Facility Zone or Knowledge Zone that is within 30m of any public space external to the zone. This excludes any land within the Major Facilities Zone or Knowledge Zone that is positioned behind an existing building or landscaping so as to be screened from the adjoining public space.

Interface area within Stage 1A or 1B or the Te Rapa North Industrial Zone: Means the area within the defined building setback of the zone for the Waikato Expressway and Te Rapa Road.

Interface Design Control Area (Ruakura Logistics Zone and Ruakura Industrial Park Zone): Means the area within 50m of a transport corridor including the Waikato Expressway but excludes any private road within the area to be used as an Inland Port.

Internal alteration of buildings: Means changes to the interior of a building that do not result in any external visible change.

Internal vehicle access: Means a combined access arrangement (e.g. accessway, right-of-way, shared driveway) serving two or more dwellings or business occupancies on the same site or serving two or more allotments.

Jetty: Means a landing pier attached to the bed of a lake or river and includes boat ramps.

L_{dn}: Means the day-night noise level which is calculated from the 24-hour L_{eq} with a 10 dBA penalty applied to the night time L_{eq} (2200-0700 hours).

L_{eq}: Means the time-averaged noise level (i.e. the constant noise level which would contain an equal amount of sound energy to the actual fluctuating noise level).

L_{max}: Means the maximum noise level recorded during the particular measurement period. L_{max} is generally used to assess the potential sleep disturbance of individual noise events.

Lake: Means a body of fresh water that is entirely or nearly surrounded by land.

Landscape design: Means the functional layout and design of a site involving the planned use of open space, landform, plant-form, water and artificial features for the purpose of beautifying or enhancing a site for human use and enjoyment.

Land use environment: Means groupings of land-use zones that provide for activities that share similar sensitivities to, or demands of, the transport network. These groups are defined in Table 15-4a of Appendix 15-4.

Less mobile users: Means those vehicle users who are less mobile but are not eligible to use accessible spaces allocated to disabled users. These include the elderly, parents with infants, people with temporary mobility disabilities.

Licensed premises: Means land, buildings or part of a building used principally for the serving of liquor, for consumption on the premises. Licensed premises include (but are not limited to) hotels, taverns, wine bars and clubs (both chartered and night).

Lifeline utilities: Means the same as in the Civil Defence and Emergency Management Act 2002.

Light industry: Means manufacturing, warehouse, bulk storage, service and repair activities which do not involve the use of heavy machinery, are carried out indoors and are unlikely to give rise to significant adverse effects beyond the site and are generally of a small scale. They include printing works, furniture manufacture, car repairs, light engineering, tradesmen's depots and the like.

Lightning rod: A grounded metal rod placed high on a building or structure to prevent damage by conducting lightning to the ground.

Line: Means the conductors (cables) of any above ground network utility infrastructure.

Loading space: Means a space on a site suitable and available for the temporary station of a vehicle which is primarily on the site to load/unload goods that are required for the nature of that particular business on that site.

Local Transport Corridor: Means any transport corridor identified as local or any other formed road not otherwise identified in Appendix 15, Figures 15-4b to 15-4f, the function and form of which is defined in Appendix 15-4.

Logistics and freight-handling activities: Includes:

-
- a) All aspects of freight handling such as loading and unloading of goods from and to road or rail, container storage, container devanning and MAF/customs procedures, warehousing and distribution/consignment activities.
 - b) All ancillary activities including container, equipment and fleet maintenance and administration activities.
 - c) All offices and facilities associated with inland port management or customs excise functions.
 - d) All offices and specialised training facilities directly related to a logistics or freight-handling activity on site, having a maximum gross floor area of 10% of the total gross floor area of a site or area of a leased site.

Logistics and freight-handling infrastructure: Includes rail siding, platforms, hardstand storage areas, private roads, lighting towers, fences, car parking, CCTV, security infrastructure, fire and hazard substance management facilities, and communications and data management infrastructure.

Lot: See Allotment.

Low flow (for the purposes of events for motorised water activities on the Waikato River): Means a river level of less than 11.80m above mean sea level (Moturiki Datum) measured at the Waikato Regional Council Victoria Bridge Recorder Station.

Low flow fixtures: Means the following.

- a) Showers using not more than nine litres of water per minute. Being the nominal flow rate measured in accordance with AS/NZS 3662: 2005 Performance of showers for bathing.
- b) Tap equipment using not more than nine litres of water per minute. Being the nominal flow rate measured in accordance with AS/NZS 3718: 2005 Water supply – Tap ware (excludes outdoor tap equipment).
- c) Toilets using not more than four litres on average per flush:
 - i. For single-flush cisterns – the discharge flush volume, determined in accordance with AS 1172.2 Water closet (WC) pans of 6/3 L capacity or proven equivalent – Cisterns.
 - ii. For dual-flush cisterns – the average flush of one full-flush discharge and four reduced-flush discharge volumes, with the full-flush discharge flush volume and reduced-flush discharge volumes determined in accordance with AS 1172.2 Water closet (WC) pans of 6/3 L capacity or proven equivalent – Cisterns.

Note

1. Toilets, showers, and taps with at least a 3 star rating in accordance with the New Zealand Water Efficiency Labelling Scheme meet this definition.

Low Flood Hazard Area: Means that part of any land affected by river or surface flooding during a 1% annual exceedance probability event. Further detail for how this Flood Hazard Area category has been derived is contained in Appendix 11. Low Flood Hazard Areas are identified on the Planning Maps.

Low Impact Urban Design and Development (LIUDD): Means design and development techniques that aim to protect aquatic and terrestrial ecological integrity while allowing urbanisation based on the following principles.

- a) *Work with nature's cycles on a catchment basis to maintain the integrity and mauri of ecosystems and minimise ecological footprints.*
- b) *Adverse effect and impact minimisation through site selection.*
- c) *Use ecosystem services and infrastructure efficiently.*
- d) *Promote and support alternative development forms that maintain, enhance or create natural spaces and increase infrastructure efficiency.*

Note

Refer to the source document for further guidance on LIUDD principles and their application. Source: M van Roon and H van Roon "Low Impact Urban Design and Development: the big picture", The University of Auckland, Manaaki Whenua Press, Landcare Research Science Series No.37, 2009.

Low-intensity sign: Means any painted or similar sign, device or symbol and includes statically illuminated signs.

Maintenance and repair of buildings and structures: Means activities required to restore to a good or sound condition after decay or damage, including strengthening and repair with similar materials. In terms of buildings, this involves no visible structural change to the external façade.

Maintenance and repair of buildings and structures (in relation to Chapter 19: Historic Heritage): Means work for the purpose of weatherproofing, plumbing and electrical work restoration and for the purpose of repair which includes patching, piecing in, splicing or consolidating of any original structure including the repair of materials and replacement of minor components where these are beyond repair or are missing. The replacement should be of original or similar material, and maintain a consistency in colour, texture, form and design as the original it replaces.

Major arterial transport corridor: Means any transport corridor identified in Appendix 15, Figures 15-4b to 15-4f as major arterial or proposed major arterial, the function and form of which is defined in Volume 2, Appendix 15-4.

Managed care facilities: Means land or buildings, in which residential accommodation, supervision, assistance, care and/or support are provided by another person or agency for residents. For the purpose of calculating the number of residents, account shall be taken of owners and/or staff and any of their children aged 16 years or older who reside on the premises. All other staff are excluded from that calculation. They include but are not limited to, emergency housing and rehabilitation centres. They exclude:

- a) A residence established in accordance with section 364(2)(d) of the Children, Young Persons and Their Families Act 1989, or replacement thereof.
- b) Apartment buildings.
- c) Hospitals.
- d) Retirement villages.
- e) Rest homes.
- f) Residential centres.
- g) Secure units.

Manoeuvring area: Means that part of the site used by vehicles to move about to gain access to and from parking spaces. Parking spaces and loading spaces may be served in whole or part by a common manoeuvring area. The manoeuvring area excludes any required queuing length.

Marae: Means land and buildings generally associated with hapu or iwi, which are used for whanau, community, cultural, social and educational gatherings (including tangi hanga), and includes whare-nui (meeting house), whare-kai (kitchen/dining hall) and ablution facilities.

Margins: Means the land/water boundary of any permanent, natural watercourse, lake or wetland.

Market days: Means an event with temporary stalls for the display and sale of food, plants and flowers to the public. Market days may be regular or irregular occurrences and are principally for marketing and selling goods produced within the Waikato Region by vendors directly involved in the growing or production process.

Mast: Means any mast, pole, tower or similar structure designed to carry antennas to facilitate telecommunications, radio-communications and broadcasting and which is fixed to the ground.

Means of compliance: Means those standards, terms, restrictions, prohibitions, classifications and other provisions forming a rule.

Medium Flood Hazard Area: Means that part of any land predicted to be affected by river or surface flooding during a 1% annual exceedance probability event. Further detail for how this Flood Hazard Area category has been derived is contained in Appendix 11. Medium Flood Hazard Areas are identified on the Planning Maps.

Meteorological instrument: Means masts and supporting sensors established for the purposes of recording and transmitting meteorological data, including anemometers and wind vanes.

Minor arterial transport corridor: Means any transport corridor identified in Appendix 15, Figures 15-4b to 15-4f as minor arterial or proposed minor arterial, the function and form of which is defined in Appendix 15-4.

Minor upgrading (in Volume 1, Chapter 25.7: City-wide – Network Utilities and the Electricity National Grid Corridor): In terms of electricity line means an increase in carrying capacity, efficiency or security of electricity and telecommunication lines and equipment where this uses the existing support structures or structures of a similar scale and character and includes:

- a) The addition of conductors to form a twinned or duplex-pairing.
- b) The reconductoring of the line with higher capacity conductors.
- c) The resagging of conductors.
- d) The addition of longer, more efficient insulators.
- e) The addition of earthwires (which may contain telecommunication lines), earthpeaks and lightning rods.
- f) The replacement of an existing overhead wire with another one or more of similar character and scale.
- g) The addition or replacement of antennas.
- h) The addition of circuits and conductors.
- i) The addition of telecommunication fittings.
- j) The replacement of existing cross-arms with cross-arms of an alternative design.
- k) The increase in voltage of electric lines from 11kV to 33kV.

- l) An increase in support structure height by not more than 15% of the base height of the support structure, and where the base height is defined as the height of the structure at date of public notification of the Plan.
- m) Support structure replacement within a similar location as the support structure that is to be replaced.

Note

It does not include an increase in the voltage of the line up to or above 110kV unless the line was originally constructed to operate at the higher voltage but has been operating at a reduced voltage, or the addition of extra lines.

In terms of telecommunications facilities means the maintenance, replacement or increase in the carrying capacity utilising the same or similar structure(s), provided that the effects of the upgrade is of the same or similar character, intensity and scale to the telecommunications facility which is being upgraded.

Minor works (in the Business 1-7, Central City, Industrial, Ruakura Logistics and Ruakura Industrial Park Zones): Means all works to an existing building for the purpose of:

- a) Maintenance activities.
- b) Repair works.
- c) Re-cladding.
- d) Internal refurbishment works.
- e) Internal alterations.
- f) Painting and signage

And other alterations and additions (in the Ruakura Logistics and Ruakura Industrial Park Zones) that are either:

- g) Not visible from a public space, or
- h) That result in additional gross floor area of no more than 25m².

Minor work (in relation to Volume 1, Chapter 19: Historic Heritage): Means the maintenance of existing site landscape features such as gardens, lawns, and planting beds; but excludes the development or re-development of the site which involves excavation, modification or disturbance of the ground.

Motorised commercial activities on land: Means Segway tours, trains, and tram rides and tours. Does not include motorsport.

Motorised recreation activity: Means indoor or outdoor recreation activity where the operation of vehicles by members of the public is the primary form of entertainment and/or recreation.

Motorised vehicle activity: Means any activity involving a motor-driven vehicle and can include cars, motorbikes and karts; but does not include modelled or scaled-down versions of vehicles operated through remote control.

Motorised water activity: Means any activity involving a motor-driven vessel and can include jetboats, water skiing, jet skis, hovercraft and the use of inboard and outboard motors, but does not include modelled or scaled-down versions of boats operated through remote control.

Motorway: Means a road declared as a motorway by the Governor-General in Council under section 138 of the Public Works Act 1981 or under section 71 of the Government Roading Powers Act 1989 and includes all bridges, drains, culverts, or other structures or works that form a part of any motorway so declared but does not include any other road, accessway or service land (or the supports) that crosses over or under a motorway at a different level.

Mowers and outdoor maintenance equipment retail: Means a business engaged in selling outdoor maintenance equipment such as, but not limited to, chainsaws and lawnmowers and any related safety equipment.

Multi-purpose facilities for international sports, events and functions: Means land and buildings that provide for:

- a) International standard playing surfaces.
- b) International standard facilities for use by professional sports codes.
- c) International standard facilities for televised sports and events broadcasting.
- d) Spectator facilities including but not limited to stands, seating, corporate and entertainment boxes, audio-visual screens.
- e) Places of assembly including function rooms and facilities for concessions to serve food and refreshments including liquor; restaurants, licensed premises and catering services, entertainment, exhibitions and conferences.

and may include:

- f) Retail and offices.
- g) Visitor accommodation.
- h) Out-catering services to serve venues, facilities and functions beyond the major facility.

Note

“Event” excludes the use of the playing areas for training, practice and rehearsals at night time, notwithstanding that lights and floodlights may be used.

National Grid Corridor and National Grid Yard: Means a buffer area around the national grid high voltage electricity transmission lines identified on the Planning Maps. The purpose of this yard and corridor is to manage activities and structures in close proximity to the National Grid transmission lines and is required by the National Policy Statement for Electricity Transmission. The corridor seeks to ensure that subdivision is designed so that future buildings will avoid the yard. The Corridors within Urban Areas and Greenfield Areas are differentiated on the Planning Maps.

Diagrammatically, the Yard and Corridor are as follows.

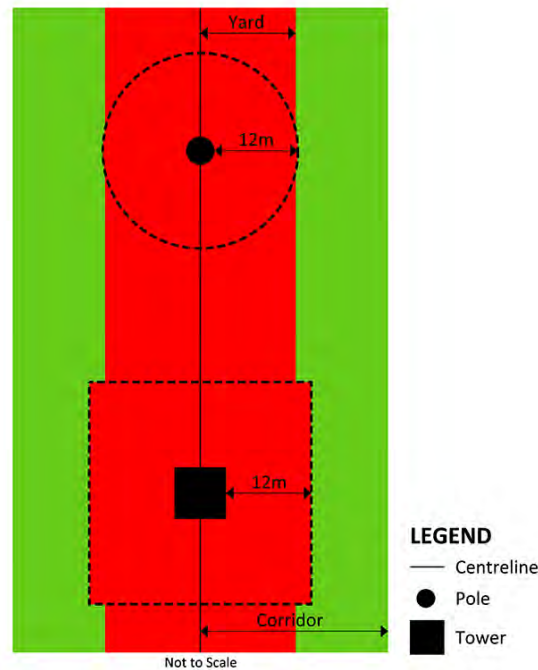

National Grid Yard (shown in red)

- the area located 12 metres in any direction from the outer edge of a National Grid support structure; and
- the area located 10 metres either side of the centreline of any above ground 110kV National Grid line on single poles (HAM-MER A, ARI-HAM A); or
- the area located 12 metres either side of the centreline of any above ground National Grid line on towers (HAM-MER B, HAM-WHU A, ARI-HAM B, HAM-KPO A, HAM DEV A).

National Grid Corridor

means the area measured either side of the centreline of any above ground electricity transmission line as follows:

- 14m for the 110kV National Grid lines on single poles (HAM-MER A, ARI-HAM A)
- 16m for the 110kV National Grid lines on pi poles
- 32m for 110kV National Grid lines on towers (HAM-MER B, HAM-WHU A, ARI-HAM B, HAM-KPO A)
- 37m for the 220kV transmission lines (HAM DEV A)

For the avoidance of doubt the National Grid Corridor and National Grid Yard do not apply to underground cables or any transmission lines (or sections of line) that are designated.

Natural and physical resources: Includes land, water, air, soil, minerals, and energy, all forms of plants and animals (whether native to New Zealand or introduced), and all structures.

Natural Ground Level: Means the lowest of:

- a) The level of the ground at the time the Section 224 certificate is issued.
- b) The finished level of the ground as the result of building construction work.
- c) The finished level of the ground as the result of any subsequent works.

Natural hazard: Means any atmospheric or earth- or water-related occurrence (including earthquake, tsunami, erosion, volcanic and geothermal activity, landslip, subsidence, sedimentation, wind, drought, fire, or flooding) the action of which adversely affects or may adversely affect human life, property, or other aspects of the environment.

Natural values (in terms of this District Plan): Means the City's key natural features – the Waikato River corridor and gully systems, peat lakes, wetlands and associated peat land, remnant and regenerated indigenous vegetation, surface and groundwater resources and the ecosystems and habitats that depend on these natural features. It also includes the landscape and visual qualities associated with these features.

Natural watercourse: Means a continually or intermittently flowing body of fresh water including streams but not including any artificial watercourse.

Net site area: Means the area of the site (including any unit site area associated with a residential unit where relevant), excluding any entrance strip, internal vehicle access or private way, except for apartment buildings and duplex dwellings in the Residential Intensification Zone.

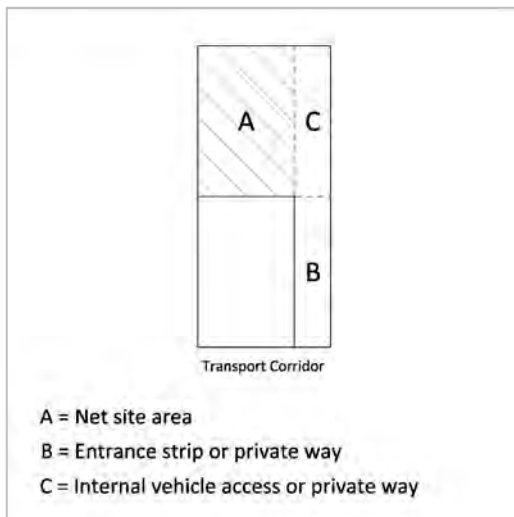

Net site area for duplex dwellings in the Residential Intensification Zone: means the area of the site (including any unit site area associated with a residential unit where relevant), including any internal vehicle access or private way, but excluding any entrance strip or private way to a rear site from any transport corridor.

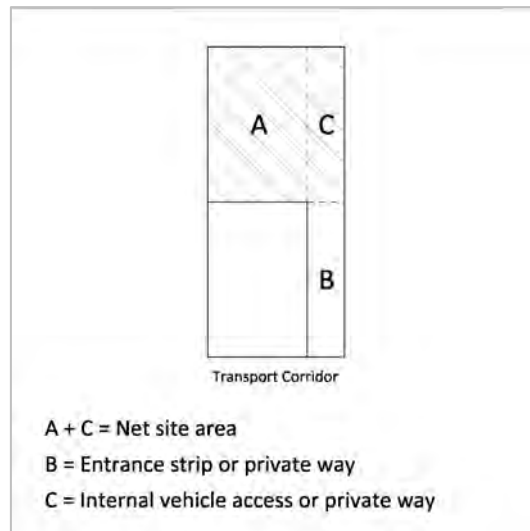

New and altered roads: Refer to NZS6806: 2010 Acoustics – Road traffic noise – New and altered roads.

Network utility: Means any activity or structure relating to:

- a) Distribution or transmission by pipeline of natural or manufactured gas petroleum or geothermal energy.
- b) Telecommunication or radiocommunication.
- c) Transformation, transmission, or distribution of electricity.
- d) The holding, transmission and distribution of water for supply.
- e) Stormwater drainage or sewerage reticulation systems.
- f) Beacons and natural hazard emergency warning devices.
- g) Meteorological services.
- h) Construction, operation and maintenance of power-generation schemes.
- i) A project or work described as a “network utility operation” by regulations made under the Resource Management Act 1991.

And includes the operation and maintenance of the network utility service. The definition of network utilities does not include roads or structures associated with the operation of roads such as signs, traffic signals or street lights. Amateur Radio is excluded from this definition; see **Amateur Radio Configuration**.

New works: Means work that adds to or otherwise physically alters the existing transport infrastructure. This includes, but is not limited to, new or altered:

- a) Paved surfaces (e.g., carriageways, pedestrian paths, cycle ways, access ways).
- b) Lanes and other changes that alter the flow of traffic, including clearways and bus lanes.
- c) Access controls or restrictions.
- d) Stormwater assets.
- e) Intersection controls such as traffic signals or roundabouts.
- f) Structures including bridges, retaining walls, underpasses and overpasses.

- g) Median barriers and segregation strips.
- h) On-road parking controls or restrictions.
- i) Street furniture such as a bus shelter, rubbish bin, seat.
- j) Landscaping, including planted areas and street trees.
- k) Traffic services.
- l) Traffic islands and pedestrian refuge islands.
- m) Vehicle crossings.
- n) Closing or stopping of roads that does not affect the function of connected transport corridors as described in the transport corridor hierarchy plan.

Noise-sensitive activities: Means residential activities (including residential accommodation in buildings which predominantly have other uses such as commercial or industrial premises), marae, spaces within buildings used for overnight patient medical care, and teaching areas and sleeping rooms in buildings used as educational facilities. For the purpose of this definition educational facilities includes tertiary institutions and schools, and premises licensed under the Education (Early Childhood Services) Regulations, and playgrounds which are part of such facilities and located within 20m of buildings used for teaching purposes.

Non-industrial activity: Means all activities other than industrial activities.

Non-residential activities: Means all activities other than residential activities.

Notional boundary: A line 20m from any side of any dwelling or the legal boundary where this is closer than 20m.

In relation to existing residential units within the Ruakura Logistics Zone means a line measured 20m from the external wall of any habitable room or the boundary of the site, whichever is the lesser.

In relation to residential unit in the Future Urban Zone means a line measured 20m from the external wall of any habitable room or the boundary of the site, whichever is the lesser.

Noxious or offensive activities: Means those activities that emit or have the potential to emit odours, gases or other substances to air which would be so offensive as to impact on the amenity values of neighbouring sites or which could constitute a health risk for people in the vicinity. They include:

- a) Blood or offal treating, bone boiling or crushing, dag crushing, fellmongering, fish cleaning or curing, gut scraping and treating, tallow melting.
- b) Flax pulping, flock manufacture or teasing of textile materials for any purpose, wood pulping.
- c) Storage and disposal of night-soil, septic tank sludge or refuse.
- d) Slaughtering of animals for any purpose other than human consumption, storage, drying or preserving of bones, hides, hoofs or skins, tanning, wool scouring.
- e) The burning of waste oil in the open air, or in any combustion processes involving fuel-burning equipment, or other than any combustion processes involving fuel-burning equipment, if carried out primarily for the purposes of producing energy,

which singly or together have a maximum fuel-burning rate of 1000kg/hr or more carbonaceous fuels or those containing hydrocarbons or sulphur.

- f) The open burning of coated or covered metal cable or wire including metal coated with varnish or lacquers or covered with plastic or rubber.
- g) Any activity with the potential to discharge asbestos to air including the removal or disposal of friable asbestos, except where it complies with the Health, Safety, and Employment Regulations for Asbestos and is supervised and monitored by Occupational Safety and Health.
- h) Burning out of the residual content of metal containers used for the transport or storage of chemicals.
- i) The open burning of municipal, commercial or industrial wastes or the use of single-chamber incinerators for disposal of waste.
- j) Any industrial wood pulp process in which wood or other cellulose material is cooked with chemical solutions to dissolve lining and the associated processes of bleaching and chemical and by-product recovery.

Offices: Means premises used for administration, consultation, or management of and shall include:

- a) Administrative offices for the purposes of managing the affairs of an organisation, whether or not trading is conducted.
- b) Commercial offices such as banks, insurance agents, or real estate agents where trade (other than for the immediate exchange of money for goods) is transacted.
- c) Professional offices such as the offices of accountants, solicitors, architects, engineers, surveyors, stockbrokers, and consultants where a professional service is available and carried out.
- d) Non-custodial premises used by Corrections staff for administration and delivery of community-based activities, including, inter alia, Probation Centres and bases for Community Work activities.
- e) Within Chapter 8 Knowledge Zone 'office' shall include space used for desk-based research and innovation, associated meeting and administration, conferencing and similar activities and excludes commercial offices and professional offices not associated with research and innovation activities.

In this context "**office**" shall exclude activities meeting the definition and performance standards for a "**home-based business**".

Open space network: Means a network of open space corridors throughout the City, consisting of both public and private land, that supports the natural environment and ecological processes. The Waikato River and associated gully system form the backbone of the open space network.

Organised recreation: Means any active sports or games or recreational pursuits for participants and spectators, the fields and structures (such as goal posts, nets, and courts) necessary to accommodate them but excludes motorised vehicle sports. It does, however, include mountain bike tracks and BMX.

Outdoor living area: Means an on-site, outdoor area for the exclusive use of each residential unit, (unless otherwise stated, e.g., communal outdoor living areas for

residential centres), free of any building or carparking, but which may include the area beneath eaves, and covered decks, balconies and terraces regardless of height.

Overland flow path: Means the route along which stormwater flows. A subset of overland flow paths is called “secondary flow path”. These routes carry water which cannot flow through the primary storm water system (usually piped) because the water flow has exceeded the capacity of that network.

Papakāinga: Means a community where tangata whenua live, primarily clustered around marae and other places of significance. Also means contemporary or ancient marae sites with or without accompanying residences or buildings. The extent of individual papakāinga should be determined in consultation with tangata whenua and is not necessarily confined to multiple-owned Māori land. The definition may also extend to include ‘taura here’ communities who establish modern/urban papakāinga.

Park: Means a defined and named area of recreation land administered or owned by Hamilton City Council.

Parking lots and parking buildings: Means land or buildings used specifically for the lease or hire of car parking as the primary activity on the site, and which are not provided to fulfil the parking requirements of the Plan for any other on-site activity. Parking lots are single level parking facilities at ground level. Parking buildings are facilities that have multiple storeys.

Parking space: Means a space on a site suitable and available for the parking of a vehicle which complies with standards referred to in Volume 1, Chapter 25.14: City-wide – Transportation.

Park furniture: Means structures designed to facilitate the use and enjoyment of a public open space and include park benches, bicycle racks, band rotunda, shelters under 20m², rubbish bins, playgrounds, adult recreation equipment, fountains, skate bowls, confidence courses and drinking fountains.

Park maintenance building: Means buildings associated with the maintenance of the park or for storage, e.g. equipment or tractor shed.

Passenger transport facility: Means land and buildings, used for scheduled passenger transport services. This may include bus bays, taxi ranks, drop-off and pick-up points, cycle parking, shelters, waiting rooms, ticket office, information centre, luggage lockers, public toilets, showers, changing rooms and ancillary activities.

Peat lakes: Means lakes which are influenced by the presence of extensive areas of peat within their catchments and dystrophic characteristics being relatively low in nutrients, low in pH and their waters stained by dissolved humic compounds.

Peat Lakes, Wetlands and Peat Lake Catchments (Chapter 20: Natural Environments): Means those areas identified on the Planning Maps as Peat Lakes and wetlands or peat lake catchment.

Pedestrian focus area: Means any transport corridor identified as being part of a pedestrian focus area in Appendix 15, Figure 15-4e, the function and form of which is defined in Appendix 15-4.

Performance assessment: Means, in relation to any rule, those provisions intended to guide Council in determination of resource consents.

Pergola: With a roof it becomes an accessory building, a pergola attached to dwelling becomes an attached accessory building.

Permeable surface: Means any part of a site which is grassed or planted in trees or shrubs and is capable of absorbing water. It does not include impermeable surfaces or any area which:

- a) Falls within the definition of site coverage.
- b) Is covered by decks which do not allow water to drain through to a permeable surface.
- c) Is occupied by swimming pools.
- d) Is paved, sealed or formed to create a solid surface.
- e) Is used for vehicle parking, manoeuvring or access.

Note

A green or living roof may provide a suitable alternative to permeable surfaces requirements but will be assessed on a case by case basis.

Personal risk: Means a measure of the danger to an individual using the transport network as part of a simple or broad Integrated Transport Assessment, as described in Appendix 15-2. Personal risk is calculated as:

$$\frac{\left(\frac{\text{Number of Fatal Crashes} + \text{Number of Serious Injury Crashes}}{\text{Number of years of data}} \right)}{\left(\frac{\text{Number of Vehicles}}{\text{Number of years of data}} \right)}$$

Pest control: Means any activity undertaken by, or at the direction of a local authority for the control, management or eradication of species identified in a Pest Management Plan prepared under the Biosecurity Act 1993.

Places of assembly: Means land or buildings which are used principally for the public or private assembly of persons for cultural, entertainment, recreation, leisure, education or similar purposes. They include conference centres, seminar rooms, gymnasiums, public halls, theatres and cinemas, display galleries and museums.

Places of worship: Means premises used for public or private religious worship, religious ceremonies, religious meetings or instruction and social gatherings directly related to the work of the religious organisation. They include temporary fundraising activities.

Planned infrastructure: Means, in the case of a specific subdivision, use or development proposal, consented or designated infrastructure. However, where district plan changes or structure plans are being considered a broader application of the term 'planned' covers infrastructure for which feasibility studies have been completed, where funding has been allocated to advance consenting or designation processes or where such infrastructure is included in strategic documents such as the Regional Land Transport Strategy.

Planting: Means the provision of trees, shrubs, and/or groundcover plantings, and may include any other vegetative forms so arranged as to improve visual amenity.

Planting Strip: Means an area of planting of a permeable nature consisting of a combination of groundcovers, shrubs and trees, which is designed in such a manner so as not to obscure visibility for road users.

Pontoon: Means a landing pier that floats on the surface of a water body and is attached to the bank of the water body.

Pool and spa retail: Means a business selling pools and/or spa-pools and any related chemicals and equipment.

Pre-development: Means pre-development characteristics and refers to the physical characteristics of the site at the point of lodgement (with Council) of a new resource consent application. Any unimplemented resource or building consents are excluded from the definition of pre-development characteristics.

Private way: As defined by Section 315 of the Local Government Act 1974. A private way is designed to provide vehicular and/or pedestrian access to a public street, and may comprise separately owned entrance strips subject to rights-of-way or a separate lot (access lot) which is jointly owned and used by adjacent lots. It includes any common area defined for the purposes of providing the vehicular access for cross-lease or unit title subdivision.

Private recreation on the surface of water: Includes canoeing, rafting, boating, kayaking, rescue and research craft of a non-commercial nature.

Produce stalls: Means any land, building or part of any building that is used for the sale, to the public only, of goods grown or produced on the property on which the produce stall is sited.

Products Transported in Bulk: includes cement, clinker, coal, cotton seed meal, palm kernel, fertilizers, sand, gravel, scoria, loose logs, wood chips, salt, soy flour, and goods of a like nature. For clarity, this definition excludes any product stored or moved in a unitised or packaged form including in a container and storage associated with the unloading or loading of containers.

Proper speed: Means speed of a watercraft discounting the contribution of any current to that speed.

Protected premises and facilities: Refer to NZS6806: 2010 Acoustics – Road traffic noise – New and altered roads.

Protected tree: Means any tree/shrub or group of trees or shrubs listed in the Significant Tree Register of this District Plan (refer Appendix 9, Schedule 9D).

Pruning, trimming and maintenance (of a significant tree or indigenous vegetation in a Significant Natural Area): Means detaching foliage, branches, and roots from a significant tree or indigenous vegetation in a Significant Natural Area.

Public art: Means artistic works created for, or located in, part of a public space or facility and accessible to members of the public. Public art includes works of a permanent or temporary nature located in the public domain. A public space means all those spaces which the public has access to or can view. This includes, but is not limited to, parks, streets, squares, gardens walkways, public plazas and building foyers.

Public floor area: Means the sum of all floor areas contained within the external walls of any building or within the boundaries of any outdoor area available for the use of the general public in association with the activity, excluding any areas used for:

- a) Lift wells, including the assembly area outside the lift doors for a maximum depth of 2m.
- b) Stairwells, including landing areas.
- c) Toilets and bathrooms.
- d) Parking areas required by the District Plan.

Public space: Means any space (whether in public or private ownership) that can be accessed without charge by everyone to use or see. This can include roads, squares, public place, parks and reserves.

Pyrotechnic displays: Means a professional fireworks display undertaken by an approved handler.

Queuing length/space: Means the area between the kerb and the on-site manoeuvring area which is used solely for queuing and/or to gain access to the manoeuvring area and on which there is no parking.

Radioactive material: Means any article containing a radioactive substance giving it a specific radioactivity exceeding 100 kilobecquerels per kilogram and a total radioactivity exceeding three kilobecquerels (radioactive substance means a radionuclide or mixture of radionuclides, either alone or in chemical combination with other elements) but excluding smoke detectors.

Railway houses: Means pre-cut timber single dwellings constructed in the 1920s by the NZ Railways for employees and their families and located in the Frankton Railway Village.

Rear building line: Means a line or lines drawn across the site creating a space behind the rear façade of any buildings.

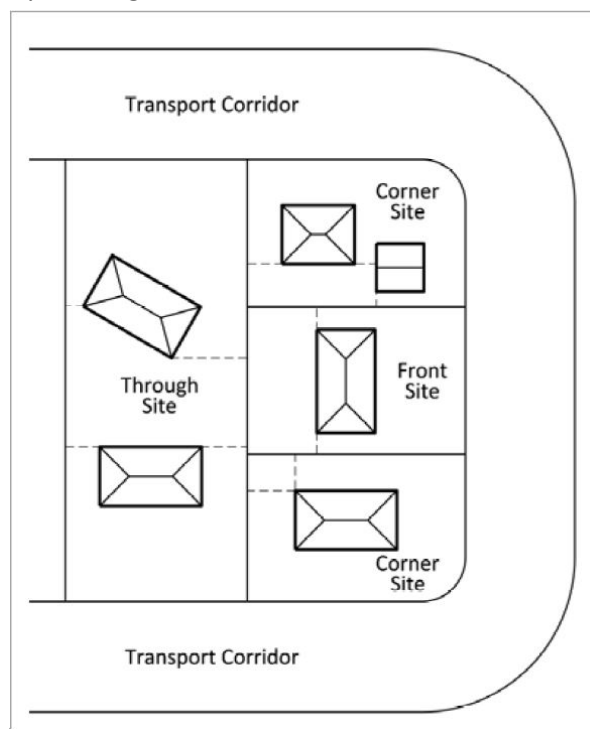

Rear Lane: Means a private way whose function is to primarily serve as a rear access to front sites or sites fronting a public reserve. This definition applies in the Rotokauri North Structure Plan area only.

Recreational activities: Means the passive or active recreational use of any land. Does not involve buildings but may include gardens, playing fields, courts, park furniture and playgrounds.

Regionally significant infrastructure: Includes:

- a) Pipelines for the distribution or transmission of natural or manufactured gas or petroleum.
- b) Infrastructure required to permit telecommunication as defined in the Telecommunications Act 2001.
- c) Ratio apparatus, as defined in section 2(1) of the Radio Communications Act 1989.
- d) The national electricity grid, as defined by the Electricity Industry Act 2010.
- e) Facilities for the generation of electricity that is fed into the national grid or a network (as defined by the Electricity Industry Act 2010).
- f) Lifeline utilities as defined in the Civil Defence and Emergency Management Act 2002, and their associated essential infrastructure and services.
- g) Flood and drainage infrastructure managed by Waikato Regional Council.
- h) Transport corridors identified in Appendix 15, Figures 15-4b to 15-4f as 'Major Arterial Transport Corridor', 'Proposed Major Arterial Transport Corridor', 'Strategic Network', or 'Strategic Network and Pedestrian Focus Area'.
- i) Hamilton City bus terminal and Hamilton Railway Station terminus.
- j) Hamilton International Airport.
- k) All KiwiRail managed railway lines that extend through the City.
- l) The electricity distribution network (as defined by the Electricity Industry Act 2010).

Proposed Plan Change 7:
Rotokauri North Private
Plan Change - Notified
Version

Reinstatement: Means work carried out to restore the exterior of a building to a completed and integrated standard and appearance. This includes the reassembling of the building as a unified whole, the replacement of defective exterior materials with materials in keeping with the character of the building, and exterior repainting.

Relocated building: Means a building originally built off site which is repositioned on to a new site, or relocated within the original site, or the removal from the original site unless a building within a Special Character Zone or identified in Schedule 8A Heritage, but does not include new buildings or accessory buildings.

Remnant or regenerated indigenous vegetation: Means vegetation dominated by indigenous species or with a substantial component of indigenous species, i.e. species native to the Hamilton Ecological District (McEwen, M.C, 1987: *Ecological Regions & Districts of New Zealand*, Department of Conservation, Wellington). This may be indigenous vegetation that remains after a larger area has been incompletely cleared, e.g. Claudelands Bush which still contains some original or old growth trees. It also includes vegetation dominated by indigenous species that has developed following

major disturbance or destruction of the original vegetation, e.g. second or third-growth vegetation which has regenerated naturally but which may be essentially different to the original vegetation, e.g. the induced kanuka forest of some Hamilton river scarps and terraces. It does not include plantations of indigenous species.

Renewal works: Means work required to repair or otherwise return existing transport infrastructure assets to their intended level of service, where for reasons of economies of scale or practicality the works have been extended to include more than that part of the asset that requires immediate attention. This includes but is not limited to:

- a) Resurfacing of part or all of a transport corridor.
- b) Replacement of stormwater assets including catchpits, culverts and kerb and channel.
- c) Pavement and footpath rehabilitation.
- d) Pavement and footpath reconstruction.
- e) Replacement of traffic services.
- f) Replacement of street furniture and lighting.
- g) Replanting of street trees and landscaping.

Research and innovation activities: Includes all activities involved in the research, development, manufacture and commercial application of advanced technology including, but not limited to, agritechology, biotechnology, chemical processes, food technology, laser physics, information technology, energy technology, transportation technology, manufacturing technology, medical technology, materials technology, telecommunications and data management and processing, soil, air and water research, infrastructure systems and management, and activities required to serve the aforementioned activities.

Residential activities: Means the use of land and buildings by people for living accommodation (whether or not any person is subject to care or supervision).

Residential building: Means any building or part thereof used, or intended to be used for human habitation.

Residential centre: Means land or buildings used for long-term shared residential accommodation occupied by five or more persons in addition to staff and not constituting a household. They include boarding houses, hostels, and other long-stay accommodation. They exclude:

- a) Visitor accommodation.
- b) Hospitals.
- c) Rest homes.
- d) Retirement villages.
- e) Managed care facilities.
- f) Secure units.
- g) Apartment buildings.
- h) A residence established in accordance with section 364(2)(d) of the Children, Young Persons and Their Families Act 1989, or replacement thereof.

Residential unit: Means a building or group of buildings, or part of a building or group of buildings that is:

- a) Used, or intended to be used, only or mainly for residential activities
- b) Occupied, or intended to be occupied, exclusively as the home or residence of one household.

Residual risk: Means the remaining level of risk control after risk control measures have been taken

Rest Home: Means land or buildings for the accommodation of the elderly and/or infirm where nursing/medical care is provided. They exclude hospitals, managed care facilities and residential centres.

Restaurant: Means premises where food is sold principally for consumption on the premises, whether or not the premises are licensed under the Sale and Supply of Alcohol Act.

Restoration: Means returning the existing physical material of heritage resources to a known earlier state.

Retail: Means the use of land or buildings where goods and services are offered or exposed to the general public for sale, hire or use, and includes premises serving food such as bakeries and cafes and ancillary storage and warehousing of goods to be sold through that retail activity, but excludes restaurants, licensed premises, offices or drive-through services.

Retail – bulky goods: Means buildings and activities involving the sale to the public of large bulky goods, such as furniture and whiteware appliances, where the gross floor area of the outlet exceeds 500m².

Retail – nurseries and garden centres: Means the use of land or buildings involving the sale of plants and associated merchandise (excluding power-driven equipment) for the home gardener, and includes premises for the propagation, display or storage of plants for sale to the public.

Retail – food and beverage: Means buildings and activities associated with preparation and sale of food which is processed or cooked and ready to eat immediately. This includes cafes, lunch bars, restaurants, takeaways, bakeries.

Retail – specialised food: Means buildings and activities associated with the display and sale of food that requires processing or cooking first. This includes butchers, fishmongers, fruit and vegetable shops.

Retirement Village: Means part of any property, building, or other premises that contains two or more independent dwelling units or their dwelling unit equivalents that provide residential accommodation in the form of independent and/or supported living provided on a bed and/or room basis (for avoidance of doubt this includes rest home), predominantly for persons in their retirement (including their spouses or partners), together with associated services and facilities. Associated services and facilities may include, but are not limited to, the following:

- a) Healthcare facilities providing medical support exclusively to village residents;
- b) Recreational service facilities for the exclusive use of village residents;
- c) Administrative offices for the day to day operation of the village.

The following are not retirement villages for the purposes of this definition:

- d) Owner-occupied residential units registered under the Unit Titles Act 2010 or owner-occupied cross lease residential units that in either case do not provide services or facilities to their occupants beyond those commonly provided by:
 - i) similar residential units that are not intended to provide accommodation predominantly for retired people and their spouses or partners; or
 - ii) residential units occupied under tenancies to which the Residential Tenancies Act 1986 applies;
- e) Boarding houses, guest houses, or hostels;
- f) Halls of residence associated with educational institutions;
- g) Residential centres or Managed care facilities; or
- h) Hospitals.

Risk: Means the likelihood of specified consequences of a specific event (e.g. an explosion, a fire or a toxic release) on people, property or the natural environment.

Risk assessment: Means the overall process of risk identification, risk analysis and risk evaluation.

Riverfront overlay: Means that area shown in Appendix 5: Central City Zone, Appendix 5-1.

Road: Means all land comprising formed and unformed roads as defined in section 315(1) of the Local Government Act 1974.

Road Controlling Authority: Means the territorial local authority, agency or approved organisation in control of roads in accordance with section 317 Control of Roads of the Local Government Act 1974. Approved organisation is defined in the Land Transport Management Act 2003.

Root protection zone: Means the minimum area required to ensure a tree's health and stability is safeguarded, as calculated using the following table.

Tree age	Vigour	Metres
Young trees (where the age of the tree is less than 20% of life expectancy)	Good vigour	6 x DBH*
	Poor vigour	9 x DBH
Mature trees (where the age of the tree is between 20% and 80% of life expectancy)	Good vigour	9 x DBH
	Poor vigour	12 x DBH
Over mature trees (where the age of tree is greater than 80% of life expectancy)	Good vigour	12 x DBH
	Poor vigour	15 x DBH

*DBH means Diameter at Breast Height which in NZ is diameter at 1.4m high (the diameter of the stem 1.4m above ground level).

Rotokauri North: [Means the Rotokauri North Structure Plan Area, which is shown on Figure 2-8A in Volume 2, Appendix 2.](#)

Routine work: Means the operational and maintenance work required to repair or otherwise return existing transport infrastructure assets to their intended level of service. This includes but is not limited to:

- a) General and environmental maintenance.
- b) Cleaning and maintenance of stormwater assets including street sweeping.
- c) Localised carriageway, footpath and cycle path repair, for example pavement digouts, patching and pothole repairs.
- d) Maintenance of street trees and landscape planting.
- e) Repair of traffic services.
- f) Repair of street furniture.
- g) Transport network inspections including structural inspections, and roughness and condition rating surveys.
- h) Structures maintenance, including repairs to guardrails and handrails associated with the structure, cleaning and painting, and stream clearing and debris removal to maintain water course under bridges.
- i) Traffic count surveys including pedestrian and cycle counts.

Ruakura Structure Plan Area: Means all of the area contained in the Ruakura Structure Plan boundary as shown in Figures 2-14 to 2-18 (Appendix 2).

Rural industry: Means any industry ancillary to rural activities which is dependent primarily on the direct handling of raw produce of, or supply of services to, farming, horticulture, intensive farming or forestry and includes; packing and storage of produce, engineering workshops for the repair and servicing of farm equipment, depots for rural transporters and farming contractors, depots for the receipt of produce for preparation for market, agricultural, horticultural, or silvicultural research, horticultural services and primary processing of horticultural produce. It excludes saw mills, abattoirs, wool scouring and the like.

Rural production: Means an agricultural activity or combination of activities for commercial gain or exchange and can include:

- a) The cultivation of land.
- b) The keeping, maintenance and farming of animals and birds (including poultry) for the production of meat, fibre, or other animal-derived produce (including offspring).
- c) Horticulture (including all forms of fruit, vegetable, flower, seed, or grain crop farming).

But excludes forestry and intensive farming.

Satellite dishes: Refer to **Dish**.

School: Means land and/or buildings used to provide regular instruction or training of children including, primary, intermediate and secondary schools, and their ancillary administrative, cultural, recreational or communal facilities. This term excludes tertiary education and specialised training facilities and childcare facilities.

Secondary containment system: Means a system in which pooling substances held in a place will be contained if they escape from their original package or container from which they can, subject to unavoidable wastage, be recovered.

Secure unit: Means land or buildings using physical barriers and/or guards for the purpose of preventing departure from the facility for the primary purpose of the protection of property and/or the security or safety of any person other than staff, visitors and residents at the facility. For the purpose of this definition 'Managed Care Facilities' that require detaining or confining a resident for their own protection or for the protection of other people in the facility are excluded.

Sensitive Transport Network: Means transport corridors identified as Sensitive Transport Network in Appendix 15, Figure 15-8.

Note

1. The Sensitive Transport Network is derived from the following factors:
 - a) The Strategic Network.
 - b) Cycle lanes – Transport Corridors with cycle lanes marked in accordance with the Traffic Control Devices (Rule) 2004.
 - c) Bus route – Transport Corridors with a key bus route operated by a local authority or an agent of a local authority.
 - d) Central City Zone – All Transport Corridors within or adjoining the Central City Zone, excluding to the east of the Waikato River (refer Planning Maps).
2. As some of these factors alter over time administrative changes to the District Plan will be required from time to time to keep the Sensitive Transport Network planning map up to date. Bus route information can be sourced from the Waikato Regional Council website or www.busit.co.nz/hamilton-routes/

Sensitive land use: As defined in the National Environmental Standard for Electricity Transmission Activities (2009), this includes the use of land for a childcare facility, school, residential building, or hospital.

Service areas: Means an area provided for the service needs (including rubbish and recycling bin storage requirements) of the occupants of a residential unit; commercial; industrial; community or recreational activity. **Service industry:** Means premises occupied by activities involving light manufacturing or the repair or servicing of goods of a light nature and includes repair of household appliances, electronic equipment assembly and servicing, craft manufacture and clothes manufacture. It does not include car repairs, furniture making and the like.

Service lane: Means land dedicated as service lane which is used from time to time for the vehicular servicing of adjacent properties.

Service Station (within the Rototuna Town Centre Zone): Means any premise primarily used for the sale of motor fuels and lubricants by retail and includes:

- a) Mechanical repair and servicing.
- b) Ancillary retail of goods and food provided that the trading space provided within the building devoted to their display, sale or hire does not exceed 50m² GFA.
- c) Vehicle washers.
- d) The hire of trailers.
- e) The storage and retailing of LPG and CNG.

But excludes:

- f) Panel beating and spray painting.

g) Heavy engineering such as engine reboring and crankshaft grinding.

Setback: Means the distance from the boundary, specified object, or building line restriction in respect of a road widening, which is required to be free, unoccupied or unobstructed by buildings from the ground upwards, with the exception of eaves (extending no more than 0.50m into any setback) and, except as otherwise provided for in this District Plan. Front and rear setbacks extend across the full width of the site and side setbacks lie along the length of a side boundary between the front and rear setbacks.

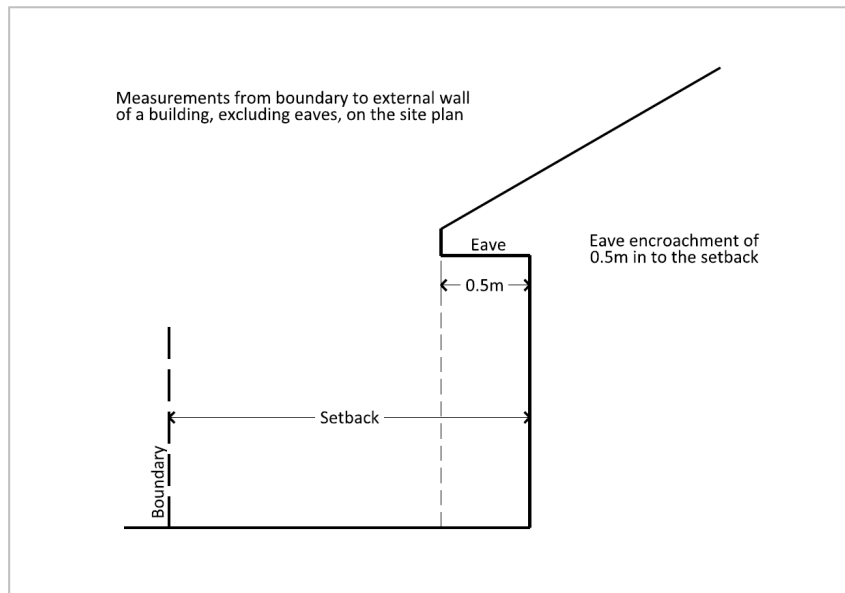

Shared path: Means a path intended to be used by both pedestrians, cyclists, mobility devices and wheeled recreation devices (in the Rotokauri North Structure Plan area).

Shared-use access way: Means, for the purpose of this District Plan, an access way to provide for the movement needs of pedestrians, including the use of motorised disability equipment (e.g. mobility scooters), and cyclists.

Shopping frontage: Means the principal face of a commercial building which is intended to be occupied by retail activities or which adjoins other such buildings and which is on or adjacent to the street frontage or which faces a customer parking area with 15 or more car spaces.

Short-stay worker accommodation: Means the same as visitor accommodation but for the exclusive use of employees or contractors.

Show home: Means a residential building and land which displays the design, construction materials, and building techniques available to potential house buyers including outside living areas and gardens. The show home is likely to include an office and is available for inspection by the public.

Sign: Means any advertising, informational or directional device or advertising matter, whether consisting of a specially constructed device, structure, erection or apparatus, or painted, printed, written, carved, inscribed, endorsed, projected on to, placed or otherwise affixed to or displayed upon anything.

Single dwelling: Means a residential building designed for, and occupied exclusively by, one household.

Site: Means an area of land which is:

- a) Comprised in a single certificate of title or in respect of which a single certificate of title could be issued without further consent from the Council.
- b) Composed of two or more lots held together in one (or more) certificate(s) of title and where no single lot can be dealt with separately without the prior consent of the Council.
- c) An area of land which has been defined for the purpose of transferring it from one certificate of title to another.
- d) An area of land which is, or is to be, used or developed as one property whether or not that use or development covers the whole or a part(s) of one or more lots.

Allotments shown on a subdivision or survey plan for the purposes of effecting cross leases or company leases or issuing separate unit titles under the Unit Titles Act 2010, shall be deemed to comprise one site.

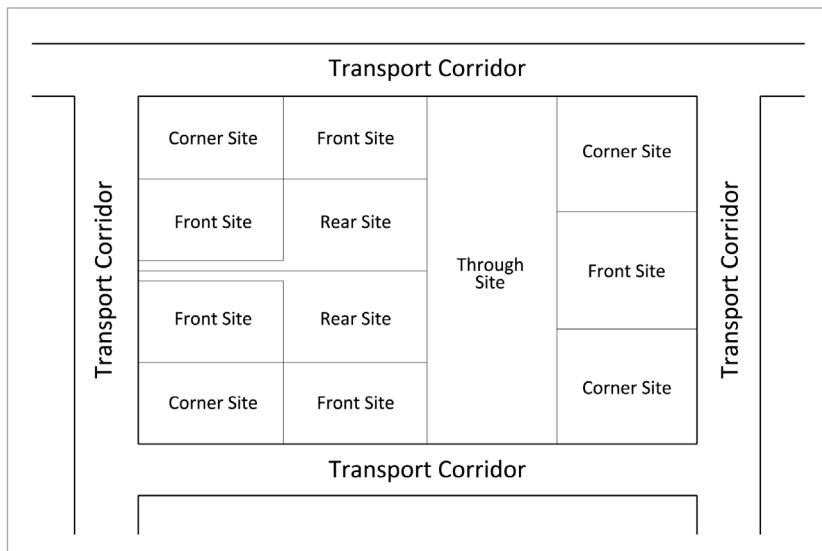

Front site: Means an allotment:

- a) Which complies with the relevant frontage requirements for the zone.
- b) Whose frontage is not less than two-thirds the maximum width of the allotment, measured parallel to its street frontage.
- c) Is not a corner site as defined below.

Corner site: Means an allotment which lies within a general change of direction (being a change of 45° or more) of the abutting street or streets.

Through site: Means any allotment having two or more street frontages that are not contiguous.

Rear site: Means any allotment other than a front, corner or through allotment as defined above.

Site coverage: Means that portion of a site which is covered by buildings, whether principal or accessory, excluding eaves and uncovered decks and terraces. The net site area shall be used for the purpose of calculating coverage.

For the avoidance of doubt when calculating site coverage, the permitted eave overhang of 1.0m shall be excluded in all circumstances.

Small-scale energy generation (produces less than 20kW): Means renewable energy generation for the purpose of using electricity on a particular site or connecting into the distribution network (but excludes solar panels supplying electricity for the site on which they are located).

Soil conservation and river control works: Means any activity undertaken by or at the direction of a local authority for the express purpose of soil conservation, river and erosion control.

Spectator facility: Means an activity within a structure or building which supplies seating or standing accommodation at any racecourse, sports ground, recreation ground or similar place, whether or not such construction is enclosed or covered.

Spill containment system: Means a structure which will contain liquid or solid hazardous substances in the event of a spill, and prevent them from entering the stormwater system or a natural water body.

State highway: Means a road whether or not constructed or vested in the Crown that is declared to be a state highway under Section 11 of the National Roads Act 1953, or Section 60 of the Government Roading Powers Act 1989, and includes:

- a) All land along or contiguous with its route that is the road.
- b) Any part of an intersection that is within the route of the state highway.

Storage (in relation to hazardous substance facilities): Means the containment of a substance, either above ground or underground, in enclosed packages, containers or tanks.

Strategic network: Means any transport corridor identified as being part of the strategic network in Appendix 15, Figures 15-4b to 15-4f, the function and form of which is defined in Appendix 15.5.

Streetscape: Means the physical features such as buildings, landscaping, street furniture and other elements that contribute to the appearance or view of a road.

Structure Plan: Means a plan that sets out the development concept for longer-term growth and the likely extent of future infrastructure provision within a locality. It may set out a logical sequence and timing for provision of infrastructure and establish the principles on which development levies are to be paid as part of a subdivision and/or development.

Structures associated with the generation, storage, transmission or distribution of any network utility: Means any pole, mast, aerial, dish, or equipment shelter used for the transmission, switching, measurement, or regulation of any approved network utility.

Studio unit: Means a residential unit with living areas combined into one main room (e.g. kitchen, lounge, and bedroom may be open plan with bathroom and toilet facilities in a separate room).

Subdivision: Has the same meaning as contained within section 218 of the Resource Management Act 1991 which means:

- a) The division of an allotment:
 - i. By an application to a District Land Registrar for the issue of a separate certificate of title for any part of the allotment.
 - ii. By the disposition by way of sale or offer for sale of the fee simple to part of the allotment.
 - iii. By a lease of part of the allotment which, including renewals, is or could be for a term of more than 35 years.
 - iv. By the grant of a company lease or cross-lease in respect of any part of the allotment.
 - v. By the deposit of a unit plan, or an application to a District Land Registrar for the issue of a separate certificate of title for any part of a unit on a unit plan.
- b) An application to a District Land Registrar for the issue of a separate certificate of title in circumstances where the issue of that certificate of title is prohibited by section 226.

The term subdivide land has a corresponding meaning.

Supermarket: This includes:

An individual retail outlet having a store footprint over 1,000m² GFA that sells, primarily by way of self service, a comprehensive range of:

- a) domestic supplies, fresh food, groceries, such as fresh meat and produce; chilled, frozen, packaged, canned and bottled foodstuffs and beverages; and general housekeeping and personal goods, including (but not limited to) cooking, cleaning and washing products; kitchenwares; toilet paper, diapers and other paper tissue products; pharmaceutical, health and personal hygiene products and other toiletries; cigarettes, magazines and newspapers, greeting cards and stationery, batteries, flashlights, light bulbs and related products; and
- b) non-domestic supplies and comparison goods comprising not more than 20 per cent of all products offered for sale as measured by retail floor space, including (but not limited to) clothing and footwear; furniture; electrical appliances; office supplies; barbecue and heating fuels; audio visual products.

Note

Retail floor space means that area of the premises to which the public has access for the purpose of shopping, together with any area:

- a) taken up for the purpose of display of goods; and
- b) any counter areas used by or occupied exclusively by staff members whilst actively engaged in serving the public.

This area does not include floor space used for:

- storerooms
- back of house including delivery areas
- trolley storage areas
- entrance lobbies
- behind counter areas, and
- checkouts.

Swimmable: Means:

- a) the water quality meets the standards set out for human health for recreation for Attribute State B as defined in Appendix 2 of the National Policy Statement for Freshwater Management 2014 (Updated August 2017); and
- b) water quality is equivalent to a black disk clarity of 1.6m or more.

Te Rapa Corridor: Means those lots shown in Volume 2, Appendix 6, Figure 6-4.

Te Rapa Dairy Manufacturing Site: Means the land identified on Figure 6-4 and the Planning Maps as Te Rapa Dairy Manufacturing Site.

Temple View Flood Hazard Area: Means that part of any land within the vicinity of Temple View affected by flooding during a 1% annual exceedance probability event. This is identified as Temple View Flood Hazard Area within the Planning Maps.

Temporary activities in a public place: This includes:

- a) Outdoor dining areas.
- b) Markets, stalls, merchandise displays and mobile shops.
- c) Busking, hawking and charitable collections.

A public place is:

- d) Under the control of Council.
- e) Open to, or being used by, the public, whether or not there is a charge for admission.

and includes:

- f) A road, whether or not the road is under the control of Council.
- g) Any part of a public place; but excludes reserves which are regulated by the Parks, Domains and Reserves Bylaw 2007.

Note

Refer to the Hamilton City Public Places Bylaw 2009 and Hamilton City Public Places Policy 2009 for restrictions to activities in a public place.

Temporary buildings and structures ancillary to an event: These include marquees and spectator stands.

Temporary logistics activities: Logistics activities provided for in the Logistics Zone (Sub Area A) as a controlled activity in Rule 10.3c and excluding freight handling activities.

Temporary sign: Means a sign that is not reflectorised, illuminated, flashing or moving and the sign is used to:

- a) Advertise that the property is for sale, and is displayed only while the property is on the market.
- b) Advise of any temporary construction project being undertaken on the site.
- c) Inform of a public election.
- d) Inform for the purpose of public notification.
- e) Advertise an event associated with any temporary recreational or community activity.

Tenancy: Tenancy is defined as the gross floor area occupied by way of exclusive use by a tenant and includes both freehold and leasehold area.

Tertiary education and specialised training facility: Means land and/or buildings used to provide regular instruction, training and/or related research not meeting the definition of school and includes tertiary education institutions, work skills training centres, and their ancillary administrative, cultural, recreational, accommodation, retailing, research or communal facilities.

TEU: Means 20-foot equivalent unit and is a measure of container throughput in the freight industry.

Three Waters: Means the three key areas of strategic water management (including associated infrastructure) within the City. Three Waters comprises:

- a) Water supply – including drinking water and other water abstracted from the Waikato River, treated and used within the City, and water for fire fighting purposes.
- b) Wastewater – liquid waste (including liquids containing waste solids) from domestic, industrial and commercial premises including toilet wastes, grey water and tradewastes.
- c) Stormwater – rainwater that runs off a surface into streams, waterways, underground aquifers, rivers and eventually, far beyond Hamilton’s boundaries, ends up in the sea.

Trade and industry training facilities: Means premises accommodating specialised education and training facilities where groups of people are given trade or industry tuition and training on a formal basis.

Traffic services: Means the transport corridor furniture, pavement markings and lighting assets that make up part of the transport infrastructure, and includes:

- a) Belisha beacons and lighting at pedestrian crossings.
- b) Carriageway and footpath lighting.
- c) Guard rails, pedestrian railings and fences.
- d) Pavement markings, including cycleway markings.
- e) Transport corridor delineation, including edge marker posts and raised and reflective pavement markers.
- f) Sight rails.
- g) Signs, including the posts.
- h) Traffic signals.
- i) Variable message signs (VMS).

Transplanting (of a significant tree or indigenous vegetation in a Significant Natural Area): Means the relocation of a significant tree or indigenous vegetation to a new site in accordance with standard arboricultural practice.

Transport corridor: Means the whole corridor that provides for carriageway, berms and any adjoining pedestrian or cycle paths, landscaping and lighting, and includes roads and access segregation strips, but excludes private roads in the Ruakura Logistics Zone and the Knowledge Zone.

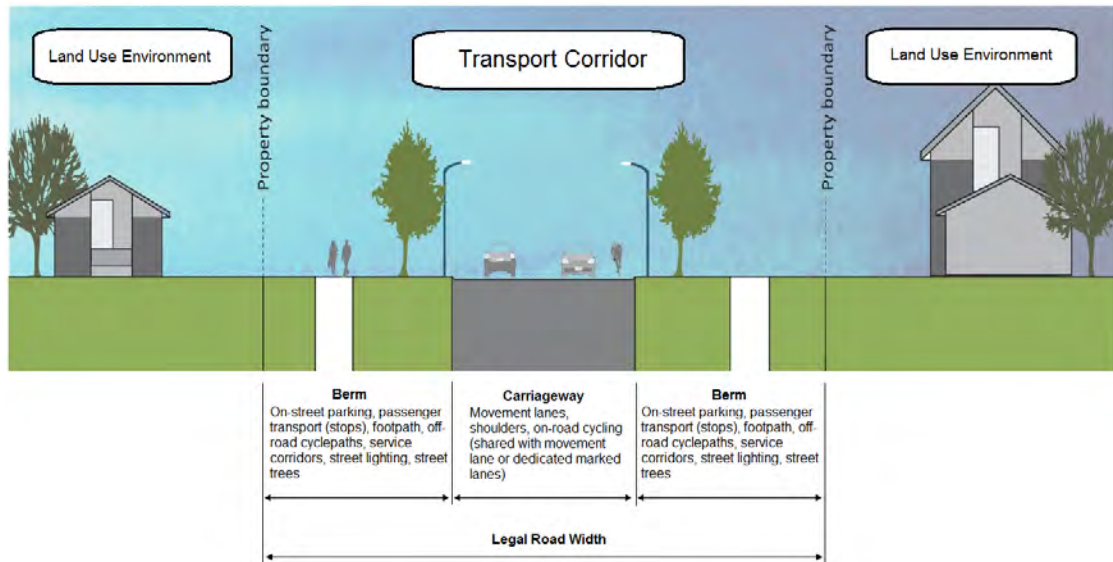

Transport depot: Means land, buildings and infrastructure used principally for the receiving, dispatching or holding of goods or passengers in transit by road or rail and any associated provision for vehicles.

Transport infrastructure: Means any structure that is necessary for the functioning of the transport network and that caters for the needs of transport users. This includes but is not limited to surfacing and pavement, traffic services and structures such as transport lighting, bridges, retaining walls, bus shelters, taxi shelters, information fixtures for bus passengers, parking and loading spaces and facilities, litter bins, drinking fountains, mobility scooter charging points, and public seating.

Transport network: Means the combined network of:

- a) Existing and future transport corridors (as shown on any Structure Plan, Figures 15-4b to 15-4f or Designation).
- b) Private roads and ways, access ways, service lanes pedestrian, cycle and passenger transport lanes or routes (both within and outside the transport corridor).
- c) Rail, river ferry and air travel routes

that provides for the movement of people and goods to, from and through the City. It includes all of the ancillary support transport infrastructure and activities, and vehicle entrances. It also includes those facilities in addition to transport infrastructure that support the use of the transport network, as well as (but not limited to) end-of-journey facilities and Travel Management Plans.

Transportation service centre: Means a development with the primary purpose of providing an accessible range of services to the motoring public using the State Highway network including commercial freight vehicles. A Transportation Service Centre may include the following uses.

- a) Service Stations and car wash facilities.
- b) Truck stops, truckers' lounges and associated accommodation.
- c) Food and refreshment facilities (including drive through services).
- d) Rest, picnic and sealed vehicle parking areas.
- e) Public toilets and showers.
- f) Lotto facilities.
- g) Playgrounds.
- h) Information centre for the provision of information for travellers and tourists.
- i) Storage area for tow trucks.
- j) Telephones, mail box, coin laundry, automatic teller machine banking facilities (ATMs) and fax/communication facilities.
- k) Premises for emergency and transport related regulatory services.
- l) Accessory buildings for the foregoing uses.

Travel plan: Means a set of measures to encourage people (e.g. employees, visitors and students) to travel to and from the site (e.g. workplace or school) by walking, cycling, passenger transport and car sharing or car pooling.

Tree (in relation to landscaping and screening): Means a large perennial plant with a woody trunk that has a mature growth height of greater than 3m or with a trunk diameter at its base of greater than 100mm.

Unit site area: Means either:

- a) A delineated area for exclusive use on a proposed plan of fee simple, cross lease, company lease subdivision.
- b) A principal unit and its accessory unit entitlements on a proposed unit title subdivision.
- c) A contiguous area of land for the exclusive use of a residential unit (including associated accessory buildings), and its required outdoor living area, service area and vehicle parking and manoeuvring space.

Upper floor levels: Means those floors at a level higher than 2.5m above ground level at any corner of external foundations of the building.

Urban Block: Means a group of lots that is bounded by roads in the Rotokauri North Medium-Density Residential Zone.

Use (in relation to the hazardous facilities screening procedure contained in Appendix 12): Means the manufacturing, processing or handling of a substance for a particular activity without necessarily changing the physical state or chemical structure of the substance involved. This includes mixing, blending and packaging operations, or the use of a substance as a cooling or heating medium. It does not include:

loading out and dispensing of petroleum products; or

the filling or drawing of substances from bulk storage tanks where the connection to the bulk storage tank is not permanent.

Vegetation removal: Means removing any vegetation or trees of any height including the root structure of such vegetation, provided that this shall not include emergency removal of protected trees and/or removal or alteration of vegetation necessary to avoid injury to persons or imminent danger to property or works undertaken by regional or territorial authorities for erosion control, flood management, or plant pest management purposes.

Vegetation trimming and maintenance: Means for the purpose of maintaining existing fence lines, vehicle tracks, walkways, cycleways, drains, ponds, utilities or other structures. It includes clearance required for the management of exotic plant species or compliance with a Pest Management Plan under the Biosecurity Act 1993 and must be in accordance with currently accepted arboricultural practice.

Vehicle crossing: Means the formed and properly constructed vehicle entry/exit point from the carriageway of any road up to and including that portion of the road boundary of the site across which a vehicle entry or exit point is permitted by this District Plan. It includes any culvert, bridge or kerbing.

Vehicle control point: Means a point on an internal vehicle access route controlled by a barrier, or similar means, at which a vehicle is required to stop.

Vibration sensitive activities: Means residential activities, marae, hospitals, facilities for the elderly, hotels, accommodation and educational establishments.

Visitor accommodation: Means any land or buildings used for day-to-day accommodation of visitors on a temporary basis (up to three months' continuous occupation during any 12-month period). It includes motels, hotels, holiday or tourist flats, backpacker accommodation, motor or tourist lodges. It excludes camping grounds and motor camps.

Waahi tapu: Means a place sacred to Māori in the traditional, spiritual, religious, ritual, or mythological sense.

Waikato Hydro System Operating Range: Means

Waikato Hydro System Operating Range		
Location	Lower Level (m)	Upper Level (m)
Cobham Bridge	11.60	15.80
Victoria Bridge	11.40	15.44
Claudlands Bridge	11.20	15.29
Whitiora Bridge	10.99	15.18
Fairfield Bridge	10.83	15.06
Ann Street	10.70	14.92
Wairere Drive	10.40	14.38

Waikato River: Means the 'Waikato River' as defined by section 6 of the Waikato-Tainui Raupatu Claims (Waikato River) Settlement Act 2010.

Waikato Riverbank and Gully Hazard Area: Means the area identified on the Planning Maps as Waikato Riverbank and Gully Hazard Area and is susceptible to land instability because of its slope and/or soil types.

Note

Council holds mapping information that separates the gully network and Waikato Riverbank components of this Hazard Area.

Walkways and cycleways: Means publicly accessible formed pathways and includes mountain bike/BMX tracks, boardwalks, shared paths, footpaths and cycle paths.

Warehouse: Means premises used for the receipt, storage and disposal of materials, articles or goods destined for a retail outlet, trader or manufacturer.

Water-sensitive techniques: These include a variety of methods designed for water conservation. They include many techniques referred to under other names, e.g. low-impact design (LID), water-sensitive urban design (WSUD), low-impact urban design and development (LIUDD), sustainable urban drainage systems (SUDS), “natural”, “green” and “sustainable”. A primary aim of water-sensitive techniques is to maximise the achievement of multiple benefits rather than a single engineering technical efficiency measure. Recognised water-sensitive techniques include:

- a) For water supply:
 - i. Rainwater reuse systems comprising rainwater tanks and appropriate connections that use rainwater instead of potable water for toilet flushing and landscape irrigation.
 - ii. Low-flow fixtures.
 - iii. Leak resistant fixtures and fittings.
 - iv. Automated greywater reuse systems that use greywater instead of potable water for toilet flushing and landscape irrigation.
 - v. Drought-resistant landscaping (e.g. xeriscape) with low water requirements.
 - vi. Conservation education.
- b) For stormwater:
 - i. Rainwater tanks/chambers/ponds for reuse or detention.
 - ii. On-site soakage.
 - iii. Green roofs.
 - iv. Reed beds/wetlands.
 - v. Rain gardens.
 - vi. Vegetative filter strips.
 - vii. Swales and depression landscaping.
 - viii. Gross pollutant traps.
 - ix. Permeable paving.
 - x. Requiring buildings to be built above the freeboard of a 1% annual exceedance probability event.
- c) For wastewater:
 - i. Low-flow and leak resistant fittings and fixtures on a water supply.
 - ii. Automated greywater reuse systems as in a) above.
 - iii. Best practice inflow and infiltration reduction methods.

- d) Biodiversity:
- i. Reed beds.
 - ii. Wetlands.
 - iii. Ponds.
 - iv. Rain gardens.
 - v. Green or living roofs.
 - vi. Water-quality protection and improvement devices.
 - vii. Maintenance or restoration of natural flow regimens.
- e) Cultural:
- i. Traditional food and fibre plants within riparian areas.
 - ii. Water-quality protection and improvement devices.
 - iii. Facilitation of appropriate water body access.
 - iv. Maintenance or restoration of natural flow regimens.

Wetland: Means permanently or intermittently wet areas, shallow water, and land-water margins that support a natural ecosystem of plants and animals adapted to wet conditions.

Wholesale retail and trade supplier: Means premises that engage primarily in the storage, distribution and sale of goods to other businesses (rather than the general public, although it may include a minor proportion of its sales to the general public), including premises engaged in supplying the construction and building industries, such as plumbing and building materials, farming and primary production supplies (including seed and grain merchants, farming and horticultural equipment suppliers, and equestrian and veterinary suppliers).

Yard: Has the same meaning as setback.

Yard area (relating to ancillary office activity): Means that area of a site used for outdoor storage or outdoor activity related to the principal activity on the site, or which is the principal activity on the site. It excludes any provided staff or customer car-parking, landscaping areas and manoeuvring and loading areas.

Yard-based retailing: Means a retail activity selling or hiring products where more than half of the display area (not including any parking, servicing, landscaping or manoeuvring areas) is located outside of an enclosed building. Such activities include, but are not limited to car, boat and heavy machinery sales yards; garden centres and landscaping supplies; automotive and boating accessories; trailer and caravan sales yards, building and farm supply outlets, and hire pools.

1.2 Information Requirements

Where noted and relevant the following information may be required to be supplied with applications for resource consents and certificates of compliance.

Any information and plans provided must be in writing and in sufficient detail and accuracy to enable a full assessment of compliance with the District Plan and to evaluate any environmental effects of the proposal.

Note

1. Wherever possible application material should also be provided in an electronic format. Checklists, forms, templates and guides are available from Council. Further general guidance on the Act and its processes is available from the Ministry for the Environment website: www.mfe.govt.nz/rma/index.html

1.2.1 All Applications

The following information must be supplied with all applications for resource consent and certificates of compliance, as relevant, at the time of lodgement.

a) **Description of the proposal**

An introductory background providing a clear description of:

- i. The proposed activity and how it is intended to operate (including information such as hours of use, numbers of users, etc).
- ii. The proposed use of all existing and proposed buildings on the site.
- iii. The current use of the site.
- iv. Resource consents applied for, identifying what aspects of the proposal do not comply with relevant standards and assessment criteria within the District Plan (including any plan changes or variations).

b) **Legal description of the subject site**

- i. Street address, legal description and allotment area(s) of the subject site.
- ii. A copy of the current Certificate of Title(s) for the subject site and documents detailing any associated:
 - Consent notices
 - Easement documents
 - Hamilton City Council covenants
 - Building line restrictions

Note

1. Certificates of Title may be obtained from Land Information New Zealand. Please ensure that the Certificate of Title consists of both the cover page and attached pages showing the survey plan.

c) **Locality plan**

A locality plan or aerial photograph showing the physical location of the subject site in relation to adjoining roads and sites.

Note

1. One copy at a scale of 1:500 is required with all applications.

d) Site plan/s

Showing the following.

- i. North point.
- ii. Allotment boundaries and dimensions.
- iii. Date the plans were drawn.
- iv. Any historic or natural feature identified in Appendix 8 or Appendix 9 as follows:
 - Schedule 8A: Built Heritage (structures, buildings and associated sites)
 - Schedule 8B: Group 1 Archaeological and Cultural Sites
 - Schedule 8C: Group 2 Archaeological and Cultural Sites
 - Schedule 9C: Significant Natural Areas
 - Schedule 9D: Significant Trees
- v. Other natural features (e.g. wetlands, springs, streams, location of banks).
- vi. Frontages to public road (noting the road's hierarchy in the Transport Corridor Hierarchy Plans in Appendix 15, Figures 15-4b to 15-4f).
- vii. Locations and layout of existing and proposed buildings (including key dimensions from buildings to boundaries).
- viii. Floor plans showing the internal room layout and identifying the floor area and any habitable rooms (the outline of any upper storey should be indicated on the site plan).
- ix. Access and vehicle crossings from road boundaries to parking, loading and manoeuvring areas.
- x. Location of buildings on adjoining sites.
- xi. Location, layout and dimensions of existing and proposed:
 - Parking spaces (cars, motorbikes, bicycle, accessible)
 - Loading spaces
 - Service areas
 - Living court areas
 - Storage areas
- xii. Location, layout, dimensions and description of existing (noting any that are to be retained or removed) and any proposed:
 - Landscaping and vegetation
 - Walls or fences
 - Signs (including sign design)
 - Utility services (e.g. water lines, street lights), which may also require details about connections to Three Waters infrastructure (including size, depth at boundary, grade and distance to boundary pegs)

Note

1. This may need to include features beyond the property boundary (e.g. utility services along the road frontage which may affect the desirable location of proposed vehicle accesses).

xiii. Original and proposed future contours of the site with contours marked at 0.5m intervals.

xiv. Nature and extent of any:

- Proposed earthworks (e.g. cut or fill, quantities)
- Designations affecting the site (refer Volume 1, Chapter 26: Designations)
- Natural hazards (including hazard layers identified by the District Plan – refer Volume 1, Chapter 22: Natural Hazards and the Planning Maps)

Note

1. Two copies at a scale of 1:100, and one reduced A4 copy is required with any application.

e) Elevation drawings

Elevation drawings of all buildings to be constructed or altered, showing the relationship, design and appearance of proposed buildings, including:

- i. The natural ground level, and the nature and extent of any proposed earthworks (e.g. cut or fill, quantities).
- ii. Existing and finished ground levels.
- iii. Maximum building height and relevant height control plane angles.
- iv. Ground floor levels in relation to the top of the kerb at entry locations from any adjoining transport corridor.
- iv. Height above floor level of any upper-storey windows.
- v. Floor levels in relation to the depth of a 1% annual exceedance probability flood event.

Note

1. Two copies at a scale of 1:50, 1:100 or 1:200, and one reduced A4 copy is required with any application.

f) Other specialist information specifically required by the District Plan

This may include Integrated Transport Assessments, Acoustic Design Certificates, and Landscape and Planting Plans. Specific information required is referred to in the following Sections 1.2.2.

g) Other resource consents/permits

A description of whether any additional resource consents are required for the proposal and whether these have been applied for (e.g. Regional Council Discharge Permits, Regional Council Water Take Permit if the proposal is likely to involve a commercial or industrial-type activity that is likely to consume more than 15m³ of water per day).

h) Assessment of environmental effects

- i. An assessment of the environmental effects (AEE) of a proposal shall be provided with applications for resource consents. Any AEE shall be prepared in accordance with the Fourth Schedule of the Act and shall discuss all the actual and potential effects of the proposal on the environment.
- ii. The amount of detail provided must reflect the scale and nature of the effects. For example, if there are major effects arising from the proposal, a detailed

analysis and discussion of these effects should be included. It may require the provision of information from a suitably qualified and experienced practitioner (e.g. a traffic engineer, planner, geotech engineer or acoustic consultant). If the effects of the proposal are small, then a less detailed AEE may be appropriate.

- iii. The AEE should identify how any adverse environmental effects are to be avoided, remedied, or mitigated, and shall also ensure that the following matters are addressed.
 - Consultation undertaken with affected parties
 - Effects of the proposal on the natural environment (including existing vegetation and natural land form), neighbourhood amenity, and infrastructure
 - Heritage issues (such as waahi tapu)
 - Site constraints (such as flooding)
 - External impacts (such as discharges)
 - Construction impacts (such as noise)
 - Other matters associated with the proposal
- iv. In the case of controlled and restricted discretionary activities the AEE need address only those matters which Council has retained control over or restricted its discretion to in the District Plan.

1.2.2 Additional Information Requirements

In addition to the information specified in 1.2.1 above the information in the following section may also be required for applications for resource consent, to enable the full assessment and determination of the proposal.

If in the following sections the words “must” or “shall are used, the relevant information must be supplied with the application at the time of lodgement.

1.2.2.1 General

- a) Plans, reports or information may also be required to be in relation to:
 - i. Details and outcomes of any consultation undertaken (e.g. Waikato iwi and local hapu, Kiwi Rail, Transpower, New Zealand Transport Agency, Heritage New Zealand Pouhere Taonga, Waikato Regional Council).
 - ii. Potential future subdivision of site.
 - iii. How the proposal will promote any design guidance referenced in the District Plan.
 - iv. Details about previous uses of the site and an assessment on whether the National Environmental Standard on Assessing and Managing Contaminants in Soil to Protect Human Health applies.
 - v. Any other relevant rules or provisions in the District Plan, such as any overlay provisions and bonus provisions.
- b) Reports and management plans demonstrating how adverse environmental effects associated with the proposed activity are to be avoided, remedied or mitigated with respect to:

- i. Nuisances such as noise, dust, odour, glare, and vibration.
 - ii. Stormwater disposal and sediment control measures.
 - iii. Hazardous facilities and substances.
 - iv. Discharges of contaminants.
- c) Concept Engineering design plans should be included for any proposed infrastructure.

Note

1. Historical and cultural sites and natural features are of significance to iwi and local hapu. In respect of any developments or activities requiring a resource consent, or for plan changes it is advisable that iwi representatives are notified at the earliest stages of planning. This will assist with the identification and mitigation of any potential adverse effects that may impact on cultural values. It is also advisable that before any archaeological surveys or investigations are undertaken iwi representatives are consulted.
2. It is recognised that traditional iwi/hapu customary processes are a complementary method of control outside the District Plan for activities that can adversely affect cultural values associated with natural features (such as the pollution of waterways that are used as important food-gathering sites). Customary processes may vary in different situations and could include:
 - *Mauri* – the notion of respect towards the health and wellbeing of significant sites
 - *Rahui* – an embargo or restriction on access to a site until it is lifted (usually in relation to a polluted or hazardous site)
3. Consultation with iwi can assist in identifying any appropriate customary processes to be followed where special tangata whenua values are identified.
4. Guidance on engineering plan information requirements is contained within the Hamilton City Infrastructure Technical Specifications.

1.2.2.2 Subdivision

a) **General**

Any subdivision application shall include plans, reports, and other information to show how the proposed allotments and access can adequately accommodate the development potential of the site.

b) **Scheme Plan**

A Scheme Plan covering the following matters should be provided.

- i. Unit site area of each proposed allotment.
- ii. Net site area of each proposed allotment.
- iii. Dimensions of all:
 - Existing boundaries
 - Proposed boundaries
- iv. Shape factor shown on all proposed allotments, including those with existing buildings.
- v. Schedule of existing easements.
- vi. Memorandum and dimensions of proposed easements.
- vii. Existing and proposed land contours at 0.5m intervals and/or sufficient spot heights to allow accurate representation of the land surface.

viii. Existing trees and other vegetation proposed for retention or removal.

ix. All existing buildings (plan views of roof and wall outlines).

Note

1. Documents should also be provided to show that existing buildings have been legally established.

x. All proposed buildings and building platforms (including buildings being re-positioned on site).

xi. Service areas, living areas, storage areas, vehicle parking areas and loading areas for all existing buildings.

xii. Parking spaces (cars, motorbikes, bicycle, accessible) and loading spaces.

xiii. Vehicle manoeuvring tracking curves.

xiv. Vehicle queuing areas.

xv. Distance of building eaves from abutting accessway or right-of-way boundaries.

xvi. Vertical cross-section of building eaves/stairs/doors and windows that encroach accessway/right of way boundaries/unit title common areas.

xvii. Existing and proposed Three Waters reticulation.

xviii. All existing and proposed vehicle crossings.

xix. Sight distances of all existing and proposed vehicle crossings.

xx. Distance of all existing and proposed vehicle crossings from intersections or railway crossings.

xxi. Distance between all existing and proposed vehicle crossings (including adjoining sites).

xxii. Location of proposed roads, reserves, easements, and essential services.

xxiii. Land to be vested in the Crown, Council, or network utility operator.

xxiv. Nature and standard of existing and proposed roads and network utility services such as sewage disposal, stormwater management, water supply, telecommunications and electricity supply.

xxv. Proposed final legal status (e.g. freehold, cross-lease, unit title).

Note

1. A checklist is provided by Council outlining all the information required with a subdivision application. Staged subdivisions should have each stage shown on a separate scheme plan, as well as a scheme plan showing the complete subdivision.

c) **Subdivision Concept Plan**

A Subdivision Concept Plan shall accompany subdivision applications for the following.

- Any single or staged subdivision creating more than 10 additional lots
- Any subdivision creating additional lots within Stage 1 of the Peacocke Structure Plan

The information provided as part of a Subdivision Concept Plan must demonstrate how the proposal meets, is consistent with, or otherwise satisfies:

- a) Objectives and Policies of:
 - i. The relevant zone.
 - ii. Chapter 3: Structure Plans (as relevant to specific Structure Plan Areas).
 - iii. Chapter 23: Subdivision.
- b) Relevant standards
- c) Relevant design guides in Appendix 1.4
- d) A subdivision concept plan shall specifically include the following information:
 - i. The location and width of proposed roads and carriageways and the integration of the roads with the existing transport network
 - ii. The location and dimension of public reserves.
 - iii. The location and dimension of shared-use pedestrian/cycle accessways
- e) Concept plans within the Peacocke Structure Plan Area shall be prepared in accordance with the neighbourhoods identified in Appendix 2.3

1.2.2.3 Master Plan for Peacocke Character Zone Neighbourhoods

A Master Plan shall accompany subdivision applications for in the Peacocke Character Zone for Fee Simple Subdivision where lots created are less than 2ha in the Terrace Area and less than 5000m² in the Gully and Hill Areas.

Master Plans shall be prepared in accordance with the neighbourhoods identified in Appendix 2-3 and the Peacocke Structure Plan (refer to Volume 1, Chapter 3: Structure Plans).

A Master Plan will also be required to include a Subdivision Concept Plan (refer to Appendix 1.2.2.2d)), an analysis over all adjoining neighbourhoods to the subject site to ensure issues impacting on the development are understood and address the following matters.

a) **Transport Network**

The Master Plan will need to outline the street pattern as well as set out the street typologies that will be used in the development, the pedestrian and cycle network and how this links with the City's/area's transport network and open space network. As part of the Master Plan a broad Integrated Transport Assessment will be required (refer to Rule 25.14.4.3).

b) **Infrastructure and Servicing**

The Master Plan will need to identify the approach to the provision of infrastructure and services which is aligned with the structure plan and the wider city infrastructure development program. Incorporate a low impact urban design and development approach in association with the development of an Integrated Catchment Management Plan, as set out in Appendix 1.2.2.6, for the stormwater catchment area in which the Master Plan neighbourhood or neighbourhoods are

located. Demonstrate the integration of any short term infrastructure solutions created under Rule 23.6.10(f) into the overall infrastructure solution for the Peacocke Structure Plan area as identified by the Master Plan.

c) **Natural Environment Network**

The Master Plan will need to identify the natural and ecological systems within the area and demonstrate how these areas have been either integrated into the urban design or how they are to be protected. The integration of the natural environment into the urban form has strong links to how the open space system is developed and the establishment of the land use patterns.

d) **Open Space Network**

The Master Plan will need to demonstrate how the open space links with the natural environment, the Waikato River esplanade, the transport network, and land uses; how the pedestrian and cycle networks have been integrated into the open space network and river esplanade.

e) **Land Use**

The Master Plan will need to identify the location of commercial and community facilities as well as residential densities. It will need to also develop the street pattern taking into account the open space, natural environment and transport network. The street pattern will also need to take into consideration the development principles set out in the structure plan and the transport corridor hierarchies.

f) **Detailed Development Response**

The approach proposed for the urban form of the neighbourhood will need to be developed. This will demonstrate the urban design and architectural responses to the opportunities and constraints within the neighbourhood and will need to consider the design guides set out in Appendices 1.4.1, 1.4.2 and 1.4.3.

g) **Staging**

The plan will need to identify the staging of development to demonstrate how any urban development created under Rule 23.6.10(f) is integrated into the overall master plan for the neighbourhood.

1.2.2.4 Landscaping Plan

Any development that is required to provide landscaping and screening under Chapter 25.5 shall provide a plan which identifies the location of the required or proposed landscaping or screening.

1.2.2.5 Water Impact Assessments

a) As part of an assessment of environmental effects the information required for a Water Impact Assessment is:

Table 1.2.2.5a: Information required for each type of Water Impact Assessment

	Type of Water Impact Assessment and what information is to be provided (✓ = required)	
Information to be provided	Type 1 (Residential activities)	Type 2 (Other activities)
i. How the proposal is consistent with, or otherwise complies with, the recommendations, measures and targets of any relevant Integrated Catchment Management Plan.	✓	✓
ii. An assessment of any potential effects (including cumulative effects) of the development in relation to its catchment.	✓	✓
iii. Details of what water-sensitive techniques are proposed. iv. Details of the expected water efficiency benefits arising from the proposed water-sensitive techniques compared to the same development without using those water-sensitive techniques. v. Details of how the water-sensitive techniques will be operated and maintained to ensure ongoing water efficiency benefits. vi. Where no water-sensitive techniques are proposed, an assessment containing reasons and justification for not incorporating water-sensitive techniques, having particular regard to the objectives and policies of the Volume 1, Chapter 25.13: City-wide – Three Waters.	✓	✓
vii. Confirmation of available Three Waters infrastructure and capacity to appropriately service the proposal.	✓	✓
viii. Details of the water demand (flow and pressure) and water sources.	✓	✓
ix. Where the water demand of the proposal is greater than 15m ³ of water per day, details of a programme explaining how the proposal intends to reduce its water consumption to achieve that level. Note Consent from the Regional Council for an increased water take may be required where a proposal is to take in excess of 15m ³ of water per day.		✓
x. Information on how wastewater (including trade waste) will be managed to minimise any impacts on the reticulated network.		✓
xi. A list of measureable targets and performance indicators to allow the efficient and effective monitoring of the proposal's compliance with any conditions arising from the Water Impact Assessment.		✓

b) The information required in a Water Impact Assessment shall be in such detail as appropriate to the scale and significance of the potential effects that the activity may have on the environment, and only if relevant to the proposal. **Note**

1. The extent and degree of assessment needed for a Water Impact Assessment may be greater when without an existing Integrated Catchment Management Plan.
2. As an outcome of the Water Impact Assessment, conditions may be applied to the development. These may include financial contributions, monitoring and the requirement for the installation of specific water sensitive techniques.

1.2.2.6 Integrated Catchment Management Plans (ICMP)

All ICMPs shall be developed in consultation with Council and Waikato Regional Council and completed in accordance with the requirements set out below. Each ICMP shall be lodged with Council, and Council shall review the content of the ICMP and certify whether it complies with the requirements of this Rule set out below.

There are three different types of ICMPs, which each have different information requirements – see Table 1.2.2.6a.

Table 1.2.2.6a: Types of ICMPs and where to find their Information requirements

Type of ICMP	Where to find the information requirements
Full ICMP	Table 1.2.2.6b
Sub-catchment ICMP for Greenfield Areas <small>See Note 1</small>	Table 1.2.2.6b
Sub-catchment ICMP for areas other than Greenfield Areas	Table 1.2.2.6c

Note

1. Greenfield Areas include the Future Urban Zone, Temple View Zone, Te Rapa North Industrial Zone, Large Lot Residential Zone and all Structure Plan Areas identified in Appendix 2.

Table 1.2.2.6b: Information requirements for Full ICMPs and Sub-catchment ICMPs for Greenfield Areas

<p>a) Maps/drawings identifying for the relevant hydrological catchment (or sub-catchment):</p> <ol style="list-style-type: none"> i. the catchment boundary; (Note: In the case of a full ICMP, this will be used in relation to determining future compliance with Rule 25.13.4.1(b)); ii. Natural features, surface water bodies, existing drainage systems and infrastructure; iii. Existing development and land uses (see f) vi below); iv. Proposed future development and land uses (see d) below); and v. The extent of the infrastructure networks that have been assessed and the location of any network constraints (see f) vii below).
<p>b) Classification of the surface water bodies within the catchment (or sub-catchment) as detailed in the Waikato Regional Plan.</p>

c) The social, economic, ecological, amenity and cultural objectives being sought for the catchment (likely to stem from a structure planning process).
d) A description of proposed urban growth, development and land use intensification within the catchment (or sub-catchment).
e) A list of the key stakeholders associated with the catchment (or sub-catchment), details of the consultation undertaken, and details of their respective views on providing for new stormwater diversion and discharge activities with the catchment (or sub-catchment).
f) An assessment of the current state of the catchment (or sub-catchment) and stormwater receiving environment/s, and the provision of catchment baseline information (including maps/drawings) on: <ul style="list-style-type: none">i. Topography;ii. Soils and geology;iii. Receiving environment –<ul style="list-style-type: none">a. Erosion;b. Ecology, including ecological sensitivity;c. Water quality (including contaminant load);d. Sediment quality; ande. Hydrology;iv. Hydrogeology;v. Flooding (including overland flow paths);vi. Existing development and land uses;vii. Existing three waters infrastructure and water source(s), including their capacity to appropriately service the proposed urban growth, development and landuse intensification within the catchment (or sub-catchment); andviii. All relevant existing resource use authorisations (including, for example, consents issued by the Waikato Regional Council for water take, wastewater and stormwater diversion and discharge activities).
g) The effects of climate change.
h) An assessment of the environmental effects, including cumulative effects over time, of all proposed water take, wastewater management and stormwater diversion and discharge activities on the catchment (or sub-catchment) and stormwater receiving environment/s. The assessment shall include maps/drawings and be in such detail as corresponds with the scale and significance of the effects on the catchment (or sub-catchment) including, but not limited to, effects on the following, taking into account the effects of climate change: <ul style="list-style-type: none">i. Natural features, surface water bodies and aquifers, including water sources;ii. Sites of cultural and/or historical significance;iii. Public health;iv. Flooding hazards, including overland flow;v. Receiving water hydrology, including base flows and peak flows in rivers and streams and long-term aquifer levels;

<ul style="list-style-type: none"> vi. Receiving water sediment and water quality; vii. Receiving water habitat, ecology and ecosystem health, including an explanation of how they will be maintained and enhanced; viii. Receiving water riparian vegetation; ix. The extent and quality of open stream channels, including erosion and sedimentation; x. Fish passage for indigenous and trout fisheries (refer to the Waikato Regional Plan Water Management Classes for applicability); xi. The natural and amenity values of stormwater receiving waters, including the management of litter than becomes entrained in stormwater; xii. Existing infrastructure; and xiii. Existing authorised resource use activities.
i) In response to the environmental effects assessment, a description and assessment of the available options for managing the effects of all proposed water take, wastewater management and stormwater diversion and discharge activities within the catchment (or subcatchment).
j) Identification of a recommended integrated catchment management approach that is based on the Best Practicable Option to avoid as far as practicable and otherwise minimise or offset actual and potential adverse effects of all proposed water take, wastewater management and stormwater diversion and discharge activities on the catchment (or sub-catchment) and its infrastructure, while ensuring the proposed urban growth, development and landuse intensification has an appropriate and sustainable water source and receives appropriate three-water services.
k) Education initiatives to support the integrated catchment management approach recommended in the ICMP.
l) Maps/drawings, a description, and a prioritised schedule of the infrastructure works to be carried out to implement the integrated catchment management approach recommended in the ICMP.
m) A list of performance measures by which the implementation of the integrated catchment management approach recommended in the ICMP will be gauged.
n) The need for any changes (including designations) or variations to the relevant District Plan, as a result of the findings and approach of the ICMP.
o) Identification of the water sensitive techniques that are appropriate, and those that are unsuitable, within the catchment or any sub-catchment.
p) All ICMPs shall be of sufficient scope and detail to inform development of Water Impact Assessments.

Note

1. Information requirements shaded in the table above do not apply to sub-catchment ICMPs for greenfield areas, but do apply to full ICMPs.
2. Council will hold some information and modelling data that may assist in preparing any type of ICMP.
3. Anyone preparing an ICMP will need to collaborate closely with Council. Council's guidance should be sought prior to commissioning any ICMP work. Council will define appropriate

methodologies and deliverables for the technical components of an ICMP and how the information and assessments are to be presented. See also the Three Waters Management Practice Notes on Council's website.

4. Catchment boundaries will not always follow the boundary of a site. Some sites may fall within more than one hydrological catchment. Water supply, wastewater and stormwater networks often cross hydrological catchment boundaries.

Table 1.2.2.6c: Information requirements for Sub-catchment ICMPs for areas other than Greenfield Areas

A Water Impact Assessment in accordance with Appendix 1.2.2.5 that also includes details of how adverse effects arising from the following will be avoided, remedied or mitigated:

- a) Flood hazards;
- b) Stormwater disposal;
- c) Discharges of contaminants; and
- d) Identified network constraints.

Table 1.2.2.6d: Completion of Full ICMP Preparation

Preparation of a full ICMP shall be considered complete when the ICMP has received technical certification by:

- a) Council that the ICMP complies with the relevant information requirements; and
- b) Waikato Regional Council that the guidance within the ICMP for stormwater diversion and discharge activities is to an acceptable standard.

1.2.2.7 Historic Heritage – Schedule 8A and 8B Sites (Historic Heritage)

Any activity requiring a resource consent relating to Schedule 8A or 8B sites (refer Volume 2, Appendix 8) shall include as part of the resource consent application:

- a) Written advice from an appropriately qualified person or body concerning the effects of the proposed activity on the cultural and heritage values identified for the site and outlining possible mitigation measures.
- b) In the case of the site having identified tangata whenua values, advice from relevant iwi.
- c) Where the site history indicates that there may be historical artefacts or other physical remains, advice from a suitably qualified and experienced archaeologist.
- d) Advice that the necessary authority to modify or damage an archaeological site has been obtained from Heritage New Zealand Pouhere Taonga under the Heritage New Zealand Pouhere Taonga Act 2014.

Note

1. An archaeological assessment, advice from Heritage New Zealand Pouhere Taonga, or consultation with iwi will not be required where there is documentary evidence held by

Council that this has previously been carried out for the site, and that the proposed new work is covered by that documentary evidence.

1.2.2.8 Comprehensive Development Plan

- a) All CDP applications shall show the total expected development for the identified Comprehensive Development Plan area (even if the development is to proceed in stages) through plans and explanatory text.
- b) Where a CDP area is to be developed in stages, the information required for each stage of the CDP process must be sufficient to enable assessment of the application in terms of the Concept Plan (Rototuna), Structure Plan and the Urban Design Guide.
- c) Any staged application for the development of a CDP area shall include an overall development framework setting out the following for the entire CDP area:
 - i. Staging,
 - ii. Main block pattern,
 - iii. Roads and access ways,
 - iv. Stormwater solutions,
 - v. Reserves, and
 - vi. Bulk and scale of the buildings.

The application for the development of a specific stage within a CDP area shall provide detailed information, including the design of urban spaces, buildings and their service infrastructure as set out in the table below.

- d) For CDP applications in the Industrial Zone refer to Rule 9.3.3 and 9.3.4.
- e) CDP applications (except those in the industrial zone) shall include where relevant, but not be limited to the following:

Note

1. Depending on the nature of the development and the stage it is at, not all information maybe required as part of the CDP.

Information Requirements	Rototuna Town Centre Zone	All other CDPs (excluding the Industrial Zone)
a) Demonstrating how the land-use pattern and features proposed in the relevant Structure Plan will be achieved.	✓	✓
b) Demonstrating via an urban design assessment how the proposed development is in general accordance with the relevant assessment criteria and design guide.	✓	✓
c) Demonstrating how the standards of the zone will be met and the extent to which the relevant assessment criteria is achieved.	✓	✓

Information Requirements	Rototuna Town Centre Zone	All other CDPs (excluding the Industrial Zone)
d) Defining the exact boundaries between the precinct and adjoining precincts.	✓	
e) The method by which the development of each Comprehensive Development Plan Area is to be managed, and how it will relate to surrounding land, and the wider Structure Plan area.		✓
f) The method by which the development of each precinct is to be managed, and how precincts will relate to each other, surrounding land and the wider Rototuna Town Centre area.	✓	
g) How transportation and other infrastructure is to be provided to enable the efficient, safe, effective, functional and sustainable delivery of infrastructure. This must take into account the subject Comprehensive Development Plan Area, integration with the surrounding CDP areas and the wider Structure Plan area.		✓
h) How transportation and other infrastructure is to be provided to enable the efficient, safe, effective, functional and sustainable delivery of infrastructure. This must take into account the subject Comprehensive Development Plan Area, integration with the surrounding CDP areas, the wider Rototuna Town Centre and the wider Structure Plan area.	✓	
i) Showing the exact location and design of proposed areas of open space, ecological links and natural features which are to be retained or enhanced, and the areas to be developed for stormwater purposes.	✓	✓
j) Site development. Illustrate:		
i. Activity types	✓	✓
ii. Building footprints	✓	✓
iii. Individual shop and business tenancy sizes	✓	
iv. The number of residential units proposed	✓	✓
v. External layout and floor areas of residential units	✓	✓
vi. How the identified yield is to be met	✓	✓

Information Requirements	Rototuna Town Centre Zone	All other CDPs (excluding the Industrial Zone)
vii. Pedestrian walkways and cycleways	✓	✓
viii. Carparking areas and vehicular circulation	✓	✓
ix. Vehicular access points between the site and public roads	✓	✓
x. Landscaping areas	✓	✓
xi. Service areas with appropriate screening	✓	✓
xii. Outdoor living courts		✓
xiii. Position of any existing buildings on adjacent land	✓	✓
xiv. How the proposal integrates with adjacent properties in terms of contributing to an overall urban design and streetscape character including treatment of building frontages, and relationship between internal boundaries of Comprehensive Development Areas (e.g. glazing and orientation)		✓
xv. How the proposal integrates with adjacent properties in terms of contributing to an overall urban design and streetscape character including treatment of building frontages (e.g. glazing and orientation)	✓	
k) Development staging: Explain if the development of the Comprehensive Development Area is to be staged, the manner and proposed timeframes for the staging and the means of managing any vacant land during the staging process.	✓	✓
l) Elevations. Illustrate: <ul style="list-style-type: none"> <li data-bbox="344 1592 823 1883">i. Building height and orientation, building exterior design features, any balconies, any artificial lighting to exterior walls and features, and how the proposed development will integrate with adjacent properties in terms of overall urban design, streetscape character and amenity. 	✓	✓
ii. Verandas	✓	
m) Signs. Give details on number, dimensions, location, content, means of support and	✓	✓

Information Requirements	Rototuna Town Centre Zone	All other CDPs (excluding the Industrial Zone)
attachment. This includes signs of the names of the residential development if applicable.		
<p>n) Transportation. Carry out an Integrated Transport Assessment (ITA) which addresses:</p> <ul style="list-style-type: none"> i. Provision for pedestrians, cyclists and passenger transport ii. Consistency with Access Hamilton and associated action plans iii. On-site provision of car parking, servicing and manoeuvring space iv. How car parking is to be provided, taking into account surrounding land uses and the opportunities for shared car parking v. Safe and efficient provision of entry and exit, including safety for all road users vi. Safe sight visibility distance for access points vii. Safe separation of access points from intersections and other access points viii. Impact of access on safe and efficient traffic flow on the transport network ix. Impact on the capacity and performance of the transport network. 	✓	✓
<p>o) Possible transport and accessibility modelling to assist in the preparation of the ITA. Applicants must also demonstrate whether a Travel Plan is required to mitigate any transport impacts from the development.</p>	✓	✓
<p>p) Servicing. Explain the provision, staging, location and capacity of network utilities and integration with existing and planned network utilities, quantity and quality of stormwater and proposed stormwater treatment, management and disposal facilities. Prepare an assessment of the impact on the infrastructure including network capacity and tolerance to support the development including future maintenance requirements.</p>	✓	✓
<p>q) Road Design. Provide details of:</p>		✓

Information Requirements	Rototuna Town Centre Zone	All other CDPs (excluding the Industrial Zone)
<ul style="list-style-type: none"> i. Form, function and design of internal roads including the integration with the existing transport network ii. Pavement and surfacing materials iii. Location of parking areas iv. Planting and street furniture v. Provision for pedestrians and cyclists vi. Location of passenger transport facilities, including corridors or priority treatments vii. Provision for road lighting viii. Proposed speed limit and design speed ix. The location and concept design of the roads (including typologies). 		
<p>r) Pedestrian and Cycle Links. Provide details of the position of walkways and cycle ways, links to adjacent sites, consideration of passive surveillance and other CPTED principles, and any artificial lighting to be used within these areas.</p>	✓	✓
<p>s) Planting and Screening. Provide details of:</p> <ul style="list-style-type: none"> i. The type of landscaping to be established in yards, carparking areas, and other landscape areas ii. Identification of the plant and tree species to be used iii. Size of the vegetation iv. Number of plants to be used v. Artificial lighting or screening to be used vi. Consideration of passive surveillance and other CPTED principles vii. Maintenance provisions. 	✓	✓
<p>t) Public Square: Show the type of landscaping and materials to be used, taking into consideration CPTED and lighting for safety, amenity and ambience. Consideration must be given to the multifunctional use of the square and its relationship with surrounding buildings and features.</p>	✓	
<p>u) Gateways: Show how the areas defined as gateways in the Rototuna Town Centre</p>	✓	

Information Requirements	Rototuna Town Centre Zone	All other CDPs (excluding the Industrial Zone)
Design Guide will be treated in terms of opportunities for landmark buildings, structures, and public art to announce the sense of arrival and departure.		
v) ICMP: Show how the development takes into account and addresses a completed and approved ICMP.		

1.2.2.8a Temple View Precincts

- a) All applications for resource consent for activities within a Temple View Precinct shall show the total anticipated development for the Precinct area through plans and explanatory text, regardless of whether the application relates to all or part of the Precinct.

Where an application for resource consent for activities within a Temple View Precinct relates to part of the Precinct, the level of information regarding anticipated development for the balance of the precinct area may be indicative but shall provide sufficient detail to demonstrate that the proposed development integrates with the existing development within the Precinct (where relevant) and the anticipated development for the entire Precinct area.

- b) Where a Temple View Precinct is to be developed in stages through the progressive lodgement of multiple resource consent applications, the information required for each stage of the Precinct process must be sufficient to enable assessment of the application against the purpose of the specific Precinct (in the context of the Character Area and/or the Heritage Area), and the Urban Design Guide.
- c) Notwithstanding a) and b) above, all applications for resource consent for the development of a Temple View Precinct shall include an overall development framework which sets out the following for the entire Precinct:
- i. Staging,
 - ii. Main block pattern,
 - iii. Roads and access ways,
 - iv. Stormwater solutions,
 - v. Reserves, and
 - vi. Bulk and scale of the buildings.

All applications for resource consent for activities within a Temple View Precinct shall provide, as a minimum, detailed information relating to the design of urban spaces, proposed buildings and service infrastructure for the proposed activities.

- d) In addition to the mandatory information requirements stated above any application for resource consent for activities within an identified Temple View

Precinct shall include the information listed in the table below, where the information is identified for the specific Precinct.

Note

1. This information requirement applies to all resource consent applications for activities within a Precinct, whether the application relates to the entire Precinct or whether the application is for a particular stage of development within that Precinct.
2. Applicants may provide additional information where considered appropriate.
3. All applications for resource consent must also comply with the requirements of the Resource Management Act 1991, including Schedule 4.

Information Requirements	Temple View Zone				
	Precinct 1	Precinct 2	Precinct 3	Precinct 4	Precinct 5
a) Demonstrate via an urban design assessment how the proposed development addresses the relevant assessment criteria and design guide.	✓	✓	✓	✓	✓
b) Demonstrate how the standards of the zone will be met and the extent to which the relevant assessment criteria are achieved.	✓	✓	✓	✓	✓
c) Demonstrate how the proposed activities will integrate with the anticipated development for the entire Precinct and the surrounding Precincts	-	✓	✓	✓	✓
d) Demonstrate how infrastructure, including transportation links, will be provided which is safe, functional and sustainable; and which will integrate with development within the Precinct as well as surrounding Precincts.	✓	✓	✓	✓	✓
e) Identify the location and design of proposed areas of open space, ecological links and natural features which are to be retained or enhanced, and the areas to be developed for stormwater purposes.	✓	✓	✓	✓	✓
f) Details of the proposed development, including:	-	-	-	-	-
i. Activity types	✓	✓	✓	✓	✓

Information Requirements	Temple View Zone				
	Precinct 1	Precinct 2	Precinct 3	Precinct 4	Precinct 5
ii. Building footprints	✓	✓	✓	✓	✓
iii. Individual shop and business tenancy sizes	✓	-	-	-	-
iv. The number of residential units	✓	✓	✓	✓	✓
v. External layout and floor areas of residential units	✓	✓	✓	✓	✓
vi. Pedestrian walkways and cycleways	✓	✓	✓	✓	✓
vii. Carparking areas and vehicular circulation	✓	✓	✓	✓	✓
viii. Vehicular access points between the site and public roads	✓	✓	✓	✓	✓
ix. Landscaping areas	✓	✓	✓	✓	✓
x. Service areas with appropriate screening	✓	✓	✓	✓	✓
xi. Outdoor living courts	✓	✓	✓	✓	✓
xii. Position of any existing buildings on adjacent land	✓	✓	✓	✓	✓
xiii. How the proposal integrates with adjacent properties in terms of contributing to an overall urban design and streetscape character including building frontages, and relationship between precinct boundaries (e.g. glazing and orientation)	✓	✓	✓	✓	✓
g) Development staging: Explain if the development of the Precinct is to be staged, the manner and proposed timeframes for the staging and how any vacant land will be managed over time until all stages of the development are complete [where this is known and/or the Precinct land is owned by a single land owner or where a single enterprise has control over	✓	✓	✓	✓	✓

Information Requirements	Temple View Zone				
	Precinct 1	Precinct 2	Precinct 3	Precinct 4	Precinct 5
development across the entire Precinct].					
h) Building height and orientation, building exterior design features, any balconies, any artificial lighting to exterior walls and features, and how the proposed development will integrate with adjacent Precinct properties in terms of overall urban design, streetscape character and amenity.	✓	✓	✓	✓	✓
i) Signs: Give details on number, dimensions, location, content, means of support and attachment. This includes signs of the names of the residential development if applicable.	✓	✓	✓	✓	✓
j) Transportation: Require the preparation of an ITA as set out in Chapter 25, Rule 25.14.4.3	✓	✓	✓	✓	✓
k) Servicing: Explain the provision, staging, location and capacity of network utilities and their integration with existing and planned network utilities. Provide details (to an appropriate level, commensurate with the nature and scale of the development), of the quantity and quality of stormwater; and any proposed stormwater treatment, management and disposal facilities. Provide an assessment of the impact on the infrastructure including network capacity and tolerance to support the development including future maintenance requirements.	✓	✓	✓	✓	✓
l) Road Design: Provide details of: <ul style="list-style-type: none"> i. Form, function and design of internal roads including the integration with the existing transport network 	✓	✓	✓	✓	✓

Information Requirements	Temple View Zone				
	Precinct 1	Precinct 2	Precinct 3	Precinct 4	Precinct 5
<ul style="list-style-type: none"> ii. Pavement and surfacing materials iii. Location of parking areas iv. Planting and street furniture v. Provision for pedestrians and cyclists vi. Location of passenger transport facilities, including corridors or priority treatments vii. Provision for road lighting viii. Proposed speed limit and design speed ix. The location and concept design of the roads (including typologies). 					
m) Pedestrian and Cycle Links: Provide details of the position of walkways and cycle ways, links to adjacent sites, consideration of passive surveillance and other CPTED principles, and any artificial lighting to be used within these areas.	✓	✓	✓	✓	✓
n) Planting and Screening: Provide details of: <ul style="list-style-type: none"> i. The type of landscaping to be established in yards, carparking areas, and other landscape areas ii. Identification of the plant and tree species to be used iii. Size of the vegetation iv. Number of plants to be used v. Artificial lighting or screening to be used vi. Consideration of passive surveillance and other CPTED principles vii. Maintenance provisions. 	✓	✓	✓	✓	✓

Information Requirements	Temple View Zone				
	Precinct 1	Precinct 2	Precinct 3	Precinct 4	Precinct 5
o) Demonstrate how the development of the Precincts will integrate with the heritage items and Archaeological site within the Temple View Zone that are listed in Appendix 8A and Appendix 8B to ensure the retention of the heritage values associated with these items.	✓	✓	✓	✓	✓
p) Demonstrate how reverse sensitivity will be managed; and how the proposed development will address the interface between the urban activities within Hamilton City and the rural activities within Waipa District.	-	-	✓	-	-

1.2.2.9 Flood Risk Assessment Report

Any application for subdivision consent creating additional lots within a Flood Hazard Area is to undertake a flood risk assessment report as outlined below.

This report is a site specific flood assessment supporting proposed subdivision, use or development of land which may be affected by flooding. Its purpose is to provide information about the subject site, the proposed activity, the likelihood, nature and extent of the relevant flood hazard and an explanation as to whether the resulting level of flood risk is acceptable. It can be used to provide a more site specific assessment of flood hazards than the broad flood hazard categorisation identified on the Planning Maps and implemented by rules in Volume 1, Chapter 22: Natural Hazards.

The flood hazard modelling information used by Council to identify Flood Hazard Areas should be used to inform this report.

- a) The report must be prepared by an appropriately experienced and qualified practitioner and consider up to at least a 1% annual exceedance probability event.
- b) The report must include, but may not be limited to, the following matters, where applicable.
 - i. The existing use and development of the site.
 - ii. An outline of the likelihood and effects of flooding on the site.
 - iii. A site layout plan showing:
 - Land potentially affected by flooding in a flood event, including areas of overland flow paths on the subject site and all adjoining sites.

- The location of the proposed activity, including any proposed building platforms, in relation to the land potentially affected by flooding.
- iv. Whether there is a reasonable or practicable alternative to locating the proposed use or development on land within a Flood Hazard Area.
- v. The sensitivity of the proposed activity to the adverse effects of flooding.
- vi. The potential risk to life, health and safety, and property during a flood event including consideration of:
 - Frequency, duration, extent, depth and velocity of flooding on the site and any access to the proposed activity,
 - Cumulative risks from interactions with any other natural hazard affecting that site (e.g. geotechnical conditions),
 - Any available flood warning time, and
 - The ability to access or evacuate the site and the danger to residents and emergency service personnel if the site or access to the proposed activity is affected by flooding.
- vii. The positive or adverse effect of the proposed activity on:
 - Overland flow paths (e.g. obstructing or diverting),
 - Hydrological capacity (e.g. reduced flood water storage capacity),
 - Flood water depths, and
 - Flood water velocities.
- viii. Whether the proposed activity creates a new or exacerbates an existing natural hazard both on or off site.
- ix. Options to avoid or mitigate the adverse effects of flood hazards and reduce risk to the proposed activity to an acceptable level, including consideration of the appropriateness of any mitigation measures proposed. This may require:
 - An elevation plan showing freeboard heights in relation to the top water flood level of a 1% annual exceedance probability event.
 - Information confirming that the proposed design of sub-floor structures, walls or fences allows for the free passage of flood waters.
 - Information confirming that the design of proposed structures or buildings is sufficient to withstand inundation by flood waters.
- c) If the report relies on flood hazard modelling information other than that used by Council to identify the Flood Hazard Areas in the Planning Maps then the report must include detail about the model methodology, assumptions and limitations, validation and any peer review.
- d) The report may recommend the refinement of the extent of the Flood Hazard Areas depicted in the Planning Maps to reflect a greater level of topographical detail than that used in Council's flood hazard modelling. An explanation of the methodology used and the nature, extent and effect of the refinement is required.

Note

1. Recommended refinements cannot alter the activity status of the proposal.

1.2.2.10 Site Management Plan (Waikato Riverbank and Gully Hazard Area)

Any application for resource consent for subdivision, use or development within the Waikato Riverbank and Gully Hazard Area or any activity not complying with standards in Rule 20.4.1, must be accompanied by a Site Management Plan prepared by an appropriately experienced and qualified practitioner. This will include, but may not be limited to:

- a) Location, extent and form of all existing and proposed:
 - i. Buildings and structures.
 - ii. Landscaping (including retaining walls and fences).
 - iii. Sealed and impermeable ground surfaces.
- b) Existing and proposed site contours at 0.5m intervals.
- c) Location, extent and species of:
 - i. Existing vegetation being removed.
 - ii. Existing vegetation being retained.
 - iii. Any proposed new vegetation.
- d) The location of vehicle access, manoeuvring and parking areas.
- e) The nature of the ground conditions and the suitability of the proposal having regard to these ground conditions.
- f) Any risk mitigation measures proposed.
- g) Land stability, erosion, earthquake (amplification and liquefaction) or any other natural hazard, including any modification to landforms and removal of vegetation.
- h) Methods proposed for site management of earthworks and stormwater.

In relation to Peat Lakes, Wetlands and Peat Lake Catchments:

A description of the measures to be undertaken to help prevent or reduce effects on:

- Ecosystems, plants and animals any any disturbance of habitats
- Any natural watercourse including any discharge of sediment to the waterway and any effect on water quality, water clarity and in-stream habitats.

1.2.2.11 Stormwater Disposal Report

Any application for resource consent for subdivision, use or development within the Waikato Riverbank and Gully Hazard Area or any activity not complying with standards in Rule 20.4.1, must be accompanied by a Stormwater Disposal Report prepared by an appropriately experienced and qualified practitioner. This will include, but may not be limited to:

- a) A description of the site, including:
 - i. Natural drainage patterns and any other drainage features (including any spring or groundwater seepage).

- ii. Its relationship to broader stormwater catchments.
- iii. Ground conditions and any particular geotechnical vulnerabilities.
- b) Existing stormwater consent constraints (if any) and whether these impact on the proposal.
- c) An assessment of the wet season (winter) water table that establishes the minimum capacity of the ground to absorb water.
- d) An assessment of post-development stormwater flows and the means to be employed to match these to predevelopment flows.

1.2.2.12 Hazardous Facilities

Any application for resource consent for Hazardous Facilities shall include as part of the resource consent application the following information.

- a) The proposed site and layout, with a description of the nature and scale of the proposed hazardous facility and associated operations.
- b) Quantities of hazardous substances proposed to be used, stored, transported or disposed of on the site.
- c) Site drainage and off-site infrastructure, including the biophysical characteristics of the site and surrounding areas (e.g. stormwater systems, transport corridors).
- d) Design and location of site access to provide safe access to and from the transport network.
- e) The sensitivity of the surrounding human, natural and physical environment and proposed measures to protect them.
- f) Separation distances from neighbouring activities and people potentially at risk from the hazardous substance facility, including consideration of the proximity to people oriented activities (e.g. childcare facilities, hospitals, schools, rest homes).
- g) Identification of on-site hazards and exposure pathways from the proposed facility, including a description of the environment actually or potentially affected by the proposal.
- h) Potential cumulative effects with neighbouring facilities.
- i) Preliminary hazard and risk assessment that systematically addresses the site hazards, likely accident scenarios, exposure pathways, receiving environments and potential environmental effects.
- j) Management of wastes containing hazardous substances, including a waste management plan.
- k) Fire safety and fire water management.
- l) Proposed contingency measures and emergency plans.
- m) Proposed monitoring and maintenance schedules.
- n) **Risk assessment.** For any activity that requires discretionary activity consent under Chapter 25.4 City-wide – Hazardous Facilities, the Assessment of Environmental Effects must contain a risk assessment that systematically addresses site hazards, likely accident scenarios, exposure pathways, receiving

environments and potential environmental effects. The detailed hazard analysis and risk assessment of installations, operations and processes involving hazardous substances is to be appropriate to the type and scale of the proposed facility. For significant facilities a quantitative risk assessment may be required. This assessment should place emphasis on:

- i. Identification of potential hazards, failure modes and exposure pathways; assessment of the probability and potential consequences of an accident leading to a release of a hazardous substance or loss of control, including, as applicable, cumulative or synergistic effects.
 - ii. Acceptability of the assessed risks, including cumulative risks.
 - iii. Residual risks after applying proposed risk control and mitigation measures.
- o) **Alternatives.** For any activity that requires discretionary activity consent under Chapter 25.4 City-wide – Hazardous Facilities, the Assessment of Environmental Effects must also contain an evaluation of alternatives (sites or locations, substances, quantities, processes or equipment, site management, etc) to determine whether there are any alternatives to the proposal, particularly where it is possible that the activity is likely to result in significant environmental effects.
- p) **Risk mitigation and control.** For any activity that requires discretionary activity consent under Chapter 25.4 City-wide – Hazardous Facilities, the Assessment of Environmental Effects must clearly identify proposed risk control and mitigation measures, with emphasis on sensitive land-use activities and environments, including, as applicable:
- i. Equipment, systems and engineered safety measures such as containment devices, fire safety apparatus and spill contingency or clean-up equipment.
 - ii. Emergency management plans, monitoring and maintenance schedules, and training programmes.

1.2.2.13 Events

Any event requiring resource consent shall, as part of the resource consent application, provide a waste management plan, transport management plan and noise management plan prepared by suitably experienced and qualified practitioners, as outlined below:

a) Waste Management Plan

The Waste Management Plan shall outline:

- i) An estimate of the types and volumes of waste to be generated by the event.
- ii) Any opportunities for waste minimisation.
- iii) Steps to be taken to maximise the use and collection of recyclables or re-usable materials.
- iv) Waste and recyclables collection, storage and transportation equipment to be provided.
- v) The method of and person responsible for the collection and disposal of waste generated by the event.
- vi) The arrangements made for the provision of post-event waste analysis and reporting of that information to the Council.

- vii) The arrangements made for the provision of litter minimisation, collection, and removal from within the event site and its immediate surrounds.

b) Transport Management Plan

The Transport Management Plan shall outline:

- i) On and off street parking provisions.
- ii) Travel plan including (but is not limited to):
 - i. Provision for access on and off the site for walking, cycling, passenger transport and the mobility impaired.
 - ii. Promotion of options for travel.
 - iii. Incentives for using passenger transport, walking or cycling.
 - iv. Cycle-parking facilities.
 - v. Map for ease of route planning.
- iii) A Temporary Traffic Management Plan prepared in accordance with the NZTA Code of Practice for Temporary Traffic Management.
- iv) The outcome of consultation with NZTA, NZ Police, emergency services, directly affected residents/businesses and Waikato Regional Council (passenger transport), wherever relevant.
- v) A contingency plan which specifies a clear set of roles and procedures in the case of a traffic accident or emergency.

c) Noise Management Plan

The Noise Management Plan shall outline:

- i) Days and times of pre-event sound testing and practice, and of the main event.
- ii) Identification of likely noise sources and the nature of noise emissions (including frequency of occurrence and duration and any special audible characteristics).
- iii) The applicable noise performance standards.
- iv) Identification of likely affected persons and any special needs of those persons.
- v) Community consultation and notification of affected persons.
- vi) Mitigation measures, including for any pre-event sound testing and practice.
- vii) Monitoring of sound levels during the event to ensure compliance with the noise performance standards.
- viii) Complaints management procedure.
- ix) Contact details of key personnel.
- x) Reporting of monitoring results to Council.

1.2.2.14 Concept Development Consents and Consents for Te Awa Lakes Adventure Park for Major Facilities and Provision of Concept Plans

Any application for a Concept Development Consent and consents for Te Awa Lakes Adventure Park for major facilities shall show the total expected development of the facility (even if the development in that area is to proceed in stages) through plans and explanatory text which may include the following information (as relevant).

- a) How the proposal is in general accordance with the urban design approach objectives and policies in Volume 1, Chapter 25.15: City-wide – Urban Design.
- b) Demonstrate how the objectives, policies and rules in Volume 1, Chapter 17: Major Facilities Zone have been met.
- c) Demonstrate how the relevant assessment criteria have been met.
- d) Details of any consultation undertaken.
- e) A Concept Development Consent application and resource consent applications for Te Awa Lakes Adventure Park shall include a concept plan which shows diagrammatically, in the form of precincts:
 - i. The general distribution of activities, buildings, open space and parking facilities.
 - ii. Provision for access to and movement within the site for vehicles.
 - iii. Pedestrian and cycle links. Show the position of existing and proposed walkway and cycleway links within the site and to adjacent sites.
 - iv. The interrelationships with the surrounding locality, including buffer areas, links to local centres and access to passenger transport.
 - v. Future development areas, major landscaping areas and protected natural heritage and cultural features.
 - vi. The parameters to which development in different areas will be subject, in terms of the general configuration and bulk of existing and proposed buildings.
 - vii. Development Staging. Explain if development of the major facility is to be staged, the manner and proposed timeframes for the staging (if known) and the means of managing any vacant land during the staging process.
 - viii. How Interface Areas on site are being appropriately planned for in the development of Concept Development Consents.
 - ix. In the case of Waikato Stadium a shading diagram showing the extent and duration of shading resulting from new development proposals over any neighbouring properties.
- f) Any other information that may be needed to assess the application.
- g) New Concept Development Consents and resource consents for Te Awa Lakes Adventure Park shall include a Broad ITA in accordance with Appendix 15-2. In Te Awa Lakes Adventure Park the ITA shall assess the levels of traffic generation to determine the implementation of transport infrastructure improvements and their staging and timing in accordance with clause 3.8.3 and Rule 3.8.5.3 in Section 3.8, Te Awa Lakes Structure Plan. The ITA shall include information

describing the proposed walking and cycling network and its connections to existing shared paths in the locality. The ITA shall include evidence of consultation with NZTA and how the outcomes of that consultation have been addressed.

- h) In Te Awa Lakes Adventure Park, a Travel Demand Management (TDM) Plan that outlines the measures to be implemented to achieve:
- Leadership of travel demand management by the consent holder;
 - Collaborative participation with Hamilton City Council, Waikato Regional Council and the local Te Awa Lakes community;
 - Strong mode shift outcomes to alternative, non-motorised and public transport utilisation:
 - Integration with existing and future public transport outcomes;
 - Multi-modal ride share alternatives and associated infrastructure;
 - Cycle network integration and enhancement;
 - Pedestrian network integration and enhancement; and
 - Minimisation of external private trip making.
- i) In Te Awa Lakes Adventure Park a management plan for the cable ski lake, and any other water bodies in the Adventure Park designed for immersion in water, including swimming, that has a purpose of achieving a swimmable water quality. The management plan is to include:
- A plan for monitoring water inflows and water quality to provide sufficient data to adaptively manage the water bodies to meet a swimmable water quality;
 - A series of triggers and actions including the use of chlorophyll-*a* as a metric, to maintain the water quality;
 - Details of who will be responsible for undertaking the monitoring and any actions to maintain the water quality of the water bodies; and
 - An Operations and Maintenance Manual for the ongoing maintenance of the water bodies.
- j) An alligator weed management plan prepared by a suitably qualified person incorporating methods to manage and control alligator weed during construction and on an ongoing basis after subdivision and development. The management plan is to include:
- i. Objectives that focus on eradication of the weed from the site but provide for an adaptive approach of stopping its spread and reducing its density if that proves impracticable;
 - ii. Identification of measures for the safe disposal or removal off site of soil or other material infested with alligator weed;
 - iii. Identification of the need for any of the management and control measures to be implemented on an ongoing basis following subdivision and development, and to be incorporated into conditions of consent and through consent notices; and
 - iv. Evidence of consultation with Waikato Regional Council and Hamilton City Council (as asset manager), including how the outcomes of that

consultation have been addressed, and a copy of any Weed Hygiene Plan that is in place in accordance with the provisions of the Waikato Regional Pest Management Plan.

Note: *The Te Awa Lakes site contains alligator weed which is defined as a 'progressive containment' pest plant in the Waikato Regional Pest Management Plan. That Plan includes rules that apply to land that is to be subdivided or developed and includes pest plants. The Waikato Regional Pest Management Plan is administered by Waikato Regional Council.*

- k) In Te Awa Lakes Adventure Park, the design and layout of activities, structures and the provision of landscaping or other screening adjacent to the Waikato Expressway and Te Rapa Road frontages of the site so as to avoid, as far as practicable, distraction to road users.

1.2.2.15 Centre Assessment Report

- a) Any applicant for a resource consent for office or retail activities that are not listed permitted activities on any sites outside the Central City or Business Zones shall provide a detailed Centre Assessment Report as part of the application excluding for a Dairy in the General Residential Zone.
- b) Any applicant for a resource consent for office or retail activities within the Central City or Business Zones may be required to provide a detailed Centre Assessment Report as part of the application, excluding:
 - i. Ancillary retail and offices in any Central City or Business zone
 - ii. Any retail activity in the Central City Zone
 - iii. Any office activity in the Central City Zone (Downtown Precinct)
 - iv. Yard based retail
 - v. Building Improvement Centres
 - vi. Wholesale and trade retail supplies
 - vii. Any office or retail activity that is provided for in the Zone Activity Status Table as Permitted but requires resource consent due to failure to comply with one or more General Standard(s).

b) Purpose

To address the potential effects associated with a proposal for retail or office activity in terms of the specified restricted discretionary activity criteria set out in Appendix 1 – clause 1.3.3H.

The content and detail of the Centre Assessment Report shall correspond with the scale, nature and potential adverse effects of the proposal. A detailed assessment may not be required if the applicant can clearly demonstrate that the proposed development is unlikely to have any significant adverse effects in relation to the matters referred to in the assessment criteria 1.3.3H.

c) Information requirements

The information shall include:

- i. A summary of the methodology and data sources used to prepare the assessment.

- ii. The following comparative indicators on the current vitality, functions and amenity of the Central City and sub-regional centres for the activity and a summary analysis of discernible trends:
 - Retail expenditure patterns
 - Floorspace and activity mix
 - Employment by type
 - Pedestrian environment and flows
 - Parking and public transport services and connections
 - Retail and office demand and supply, including vacancy levels.
- iii. The existing and consented development located outside of the Central City and/or sub-regional centres, which has been taken into account when assessing the potential adverse effects of the development.
- iv. Any external non-development factors such as macroeconomic trends or site specific factors that could influence the above indicators
- v. Information should be included to demonstrate the appropriateness of the timeframes used to demonstrate trends and future predictions.

1.2.2.18 Ruakura Logistics Zone

- a) Applications for Freight-handling activities and Logistics and Freight-handling infrastructure within the Inland Port (Sub Area A (Inland Port)), see Figure 2-14, shall be accompanied by a Noise and Vibration Management Plan for the relevant stage of the Inland Port which shall include the following:
 - i. The result of any noise monitoring undertaken to demonstrate that earlier stages of Inland Port development and logistics activities, if any, meet noise performance standards, with an analysis of compliance as necessary.
 - ii. A recalibrated model based on the results of the above monitoring.
 - iii. The identification of construction and operational noise and vibration sources and the noise emissions associated with each stage of the development of the Inland Port (Sub Area A (Inland Port)), including refrigerated containers.
 - iv. The applicable noise performance standards to be achieved at different times of the day.
 - v. The applicable vibration performance standards.
 - vi. Operational strategies and configurations adopted for each stage based on modelling which achieve compliance with the noise and vibration performance standards set out in Chapter 25.8.
 - vii. Plans and diagrams sufficient to illustrate the location, scale and dimensions of the noise barrier designed to achieve compliance with the noise performance standards set out in Chapter 25.8.
 - viii. Strategies and configurations to be adopted during construction which achieve compliance with the noise and vibration performance standards set out in Chapter 25.8.

- ix. A signed statement by its author stating that the measures identified will enable the activity to comply with the noise and vibration performance standards set out in Chapter 25.8.
- x. A subsequent signed statement by the designer of the noise barrier that it has been constructed in a way that makes it fit for purpose.
- xi. Identification of persons potentially affected by noise and vibration from the operation and construction of the Inland Port (Sub Area A (Inland Port)) (including but not limited to members of the Inland Port Community Liaison Committee required under Rule 10.5.1), a record of meetings held and consultation undertaken with such potentially affected persons, and responses to matters raised in consultation.
- xii. Procedures for monitoring noise levels to ensure compliance with the noise performance standards in Chapter 25.8.
- xiii. Management of noise emissions at night, with particular emphasis on the methods to effectively manage the noise effects on noise sensitive activities and which avoid or minimise sudden and/or loud noises at night.
- xiv. Procedures for receiving and addressing noise complaints.
- xv. Methods for updating the Noise and Vibration Management Plan as appropriate to respond to changing requirements.
- xvi. Contact details of key personnel, including the name of the person with overall responsibility for ensuring noise limits are met.
- xvii. An independent peer review report prepared by a suitably qualified and experienced expert acceptable to the Council that considers all aspects of the Noise and Vibration Management Plan, in particular the accuracy of modelling, the matters of discretion listed in Appendix 1.3.3 N2 Ruakura and compliance with noise and vibration performance standards.

1.2.2.17 Knowledge Zone Precinct C

1.2.2.17.1 Centre Assessment Report

a) Purpose

To address the potential effects associated with a proposal for retail, office and other activities in terms of the specified restricted discretionary activity criteria set out in Appendix 1.3.3H- Functionality, Vitality and Amenity of Centres and 1.3.3 N Ruakura.

The content and detail of the Centre Assessment Report shall correspond with the scale, nature and potential adverse effects of the proposal. A detailed assessment may not be required if the applicant can clearly demonstrate that the proposed development is unlikely to have any significant adverse effects in relation to the matters referred to in the assessment criteria 1.3.3H.

b) Information requirements

The assessment shall include the following information:

- i. A summary of the methodology and data sources used to prepare the assessment.

- ii. The following comparative indicators on the current vitality, functions and amenity of the Central City and sub-regional centres for the activity and a summary analysis of discernible trends:
 - Retail expenditure patterns
 - Floorspace and activity mix
 - Employment by type
 - Pedestrian environment and flows
 - Parking and public transport services and connections
 - Retail and office demand and supply, including vacancy levels.
- iii. The existing and consented development located outside of the Central City and/or subregional centres, which has been taken into account when assessing the potential adverse effects of the development.
- iv. Any external non-development factors such as macroeconomic trends or site specific factors that could influence the above indicators.
- v. Information should be included to demonstrate the appropriateness of the timeframes used to demonstrate trends and future predictions.

1.2.2.18 Land Development Plans - Ruakura

Land Development Consent

An application under Rule 3.7.4.2 shall be accompanied by a Land Development Plan including the following information:

General

- a) The exact boundaries between the Land Development Plan and adjoining Land Development Plan Areas.
- b) The exact boundaries of any Open Space Zone included in the Land Development Plan.
- c) Where an application for Land Development Consent is made for part of a Land Development Plan Area (as shown on Figure 2-16), pursuant to rule 3.7.4.2b) the following indicative information for the balance area of each Land Development Plan Areas shall be provided as part of that application:
 - i. The location and width of proposed roads and carriageways and their integration with the existing and future transport networks;
 - ii. The location of proposed Ruakura Strategic Infrastructure to ensure connectivity across the entire structure plan and adjacent Land Development Plan areas;
 - iii. The National Grid electricity transmission network;
 - iv. Where the Land Development Plan contains any part of the Inland Port (Sub Area A (Inland Port)) an indicative layout plan showing internal roads, hardstand and impermeable areas, crossing points under transmission lines, indicative building locations, future rail sidings and connections to the East Coast Main Trunk railway

and clearances between finished surface levels of the Inland Port and the National Grid electricity transmission network;

- v. The location and size of storm water treatment and control measures; and
- vi. The location, size and purpose of open spaces.

Concept Layout Plan

- d) The location, width and design of proposed roads and carriageways (including lighting, street furniture and signs) and the integration of roads with the existing and future transport network and the National Grid electricity transmission network.
- e) The location of proposed Ruakura Strategic Infrastructure to ensure connectivity across the entire structure plan and adjacent land development plan areas.
- f) Within the Inland Port (Sub Area A (Inland Port)) – an indicative layout plan showing internal roads, hardstand and impermeable areas, crossing points under transmission lines, indicative building locations, future rail sidings and connections to the East Coast Main Trunk Railway and clearances between finished surface levels of the Inland Port and the National Grid electricity transmission network.
- g) The location and design of storm water treatment and control measures.
- h) The location and dimension of open spaces, and the total area provided for each open space purpose consistent with the purpose of the Ruakura Open Space Zone and Ruakura Structure Plan area.
- i) The location and dimension of pedestrian and cycle ways.
- j) Existing and proposed Three Waters infrastructure necessary to service the Land Development Area.
- k) Existing and proposed ground levels and associated earthworks (Note: consent for earthworks within a National Grid Yard may also be required under Rule 25.2.3 or 25.7.4).
- l) Methods to provide public access to and use of the Open Space, except as may need to be limited for safety reasons.
- m) Consistency with the overall strategic infrastructure network for the structure plan as shown on Figures 2-15A and B Ruakura Strategic Infrastructure (Appendix 2).

Landscape Concept and Ecological Enhancement Plan

- n) A Landscape Concept and Ecological Enhancement Plan that includes the following:
 - i. A landscape concept for the area of open space included in the Land Development Plan, consistent with the purpose of the Ruakura Open Space Zone and Ruakura Structure Plan area.
 - ii. Details of landscape treatment of streets, footpaths and cycleways.
 - iii. Details of landscape treatment of storage basins, swales and linear wetlands, which show at a minimum the following:
 - a. 100% cover of indigenous wetland vegetation in linear wetlands associated with arterial, collector roads and local roads in Industrial Park Zone; and

- b. 80% cover of indigenous wetland vegetation in linear wetlands associated with the main greenway corridor, including the Silverdale Road to Mangaonua greenway and the corridor adjoining the expressway in the Logistics and Industrial Park Zones.
- iv. Details of the Landscape Buffer Areas in the Inland Port (Sub Area A (Inland Port)) required in Rule 10.5 and as shown on Figure 2-17 Inland Port Building Setbacks and Landscape Controls (Appendix 2). These details shall include:
 - a. Measures to ensure that filled ground provides optimum growing conditions such as avoiding the placement of compacted fill and installing topsoil that has been stripped and stockpiled according to sound practice.
 - b. Plant types and species, sizes at time of planting and spacing sufficient to achieve the screening purpose of the buffer areas.
 - c. The selection of quick growing trees that are capable of achieving the planting heights (other than understorey and edge planting) specified on Figure 2-17 Inland Port Building Setbacks and Landscape Controls (Appendix 2) according to the following growth rates:
 - Year 1 = 2m
 - Year 5 = 6m-8m
 - Year 8 = 8m-10m
 - Year 10 = 10m-12m
 - d. Details of ongoing maintenance to ensure the planting achieves the best possible growth rates.
- v. Details of the Landscape Buffer Areas for Percival Road required under Rules 10.5.4.3 and 11.5.3 and as shown on Figures 10.5.4.3a and 11.5.3a. These details shall include those as outlined in iv a), b) and d) above.
- vi. Measures to ensure the implementation and ongoing maintenance of the Landscape and Ecological Concept Plan. In particular, the Landscape and Ecological Concept Plan shall detail the proposed timeframes for the implementation of the planting in the Landscape Buffer Areas in the Inland Port (Sub Area A (Inland Port)) relative to the proposed development and operation of logistics and freight-handling activities and infrastructure.
- vii. A design statement, and details of plant species¹ and materials including indigenous trees and shrubs bordering the linear wetland to improve the ecological function without hindering their treatment functions.

¹ **Note:**

On the basis of the soil type within the storage basin to be planted, shrubland and forest species shall be selected from Clarkson B D, Clarkson B R and Downs T M, 2005: Indigenous Vegetation Types of Hamilton Ecological District, CBER Contract Report 58. The percentage vegetation cover of the storage basins shall be consistent with Hamilton City Council Infrastructure Technical Specifications October 2013 or its replacement.

- viii. Methods in the design and layout of Open Space to provide for the amenity of adjoining and adjacent activities.
- ix. The design of the linear wetlands to support black mudfish, shortfin eels and longfin eels, including a range of vegetation suitable to support these fish species without hindering the treatment functions of the linear wetland. The design shall take account of risk factors for black mudfish including competition from pest fish, lack of suitable peat soils, drying out, lack of cavities for mudfish to aestivate (sleep over summer) and inappropriate pH of water due to lack of peat. This may necessitate retention or incorporation of peat soils in the construction of the linear wetlands.
- x. Methods to ensure implementation of a Native Fish Management Plan for the Land Development Plan Area consistent with the requirements of the Structure Plan Area-wide Native Fish Management Plan.
- xi. Methods to ensure implementation of a Native Lizard Management Plan for the Land Development Plan Area consistent with the requirements of the Structure Plan Area-wide Native Lizard Management Plan.
- xii. The Native Fish Management Plan and Native Lizard Management Plan prepared by suitably qualified and experienced ecologist and shall include:
 - a. containment and translocation methods for at risk species;
 - b. methods to ensure adequate separation between black mudfish and longfin eels;
 - c. adaptive management, monitoring and response process to determine the success or otherwise and to implement a contingency plan if necessary; and
 - d. an analysis of risk relating to timing of collection, containment and translocation.

Water Impact Assessment

- o) A Water Impact Assessment based on anticipated development in the Land Development Plan that includes the following:
 - i. How the proposal is consistent with, or otherwise complies with, the recommendations, measures and targets of any relevant Integrated Catchment Management Plan.
 - ii. Where there is no relevant Integrated Catchment Management Plan, how the proposal is consistent with the development of and gives effect to Ruakura Strategic Infrastructure including as shown on Figures 2-15A and B in Appendix 2 for the entire structure plan area.
 - iii. How the Land Development Plan provides for the eventual diversion of any temporary connections to strategic infrastructure, including timing or triggers for such diversions.
 - iv. An assessment of any potential effects (including cumulative effects) of the development in relation to its catchment. In particular, the assessment should

- include consideration of potential construction effects and the potential effects of new stormwater devices on adjacent private property.
- v. Details of what water-sensitive techniques are proposed and methods of implementation.
 - vi. Details of the expected water efficiency benefits arising from the proposed water-sensitive techniques compared to the same development without using those water-sensitive techniques.
 - vii. Details of how the water-sensitive techniques will be operated and maintained to ensure ongoing water efficiency benefits.
 - viii. Confirmation of available Three Waters infrastructure and capacity, existing and proposed, to appropriately service anticipated development in the Land Development Plan area and the wider structure plan area.
 - ix. Details of the water demand (flow and pressure) and water sources.
 - x. An assessment of the effect that any staged or interim development and infrastructure has on the strategic network described in Figures 2-15A and B Ruakura Strategic Infrastructure (Appendix 2) including an assessment of when any diversion to that strategic network is required to restore the city wide network capacity that was being used on an interim basis.

Note:

Consent from the Regional Council for an increased water take may be required where a development proposal is to take in excess of 15m³ of water per day.

Integrated Transport Assessment

- p) An Integrated Transport Assessment (ITA) for anticipated development within the Land Development Plan area, prepared in accordance with the requirements of Rule 25.14.4.3 and confirming that the anticipated levels of development will comply with Rule 3.7.4.3 Staging and Traffic Requirements. Prior to approving an ITA or Land Development Plan for the first stage of the Inland Port (Sub Area A (Inland Port)), the upgrading requirements of Ruakura Road from, and including, the Silverdale Road intersection to Wairere Drive shall be reviewed. Any upgrading required shall be agreed with the Hamilton City Council, and be completed in accordance with the agreement before operation of the Inland Port (Sub Area A (Inland Port)) or other development commences.
- q) Details of how the Land Development Plan has been designed to align with the Cyclist and Pedestrian Network Plan in Figure 2-18 Ruakura Cyclist and Pedestrian Network Plan in (Appendix 2), including the grade separation of facilities on arterial routes.
- r) Details of any proposed crossing of the East Coast Main Trunk Railway by the Spine Road, which show how it will be grade-separated.

Mitigation of Adverse Land Development Effects on Habitats

- s) Details of how land development avoids, remedies or mitigates adverse effects on, or where possible enhances, any significant habitats of indigenous fauna.

Medium Density Residential Zone

- t) The layout of roads, public spaces and lots, showing how compliance with a minimum net density of 16 dwellings per hectare will be achieved.
- u) The specific location and extent of the Integrated Retail Development consistent with that shown on Figure 2-14 Ruakura Structure Plan – Land use (Appendix 2).

Open Space Provisions

The following components of the open space network are to be considered when developing a Land Development Plan to ensure the various functions are not compromised. The Land Development Plan shall demonstrate the maintenance and development of:

- v) Greenway - In addition to the stormwater management function, the greenway shall create opportunities for improved habitat and ecological benefits in the Ruakura Structure Plan area and in downstream receiving environments.
- w) Gullies - Layout of the residential area is to be designed to provide opportunities for the restoration and enhancement of the Kirikiriroa Stream headwaters.
- x) Visual amenity and buffer between incompatible activities – in particular the following open space areas identified on the Ruakura Structure Plan are intended to provide a buffer function: (See Figure 2.14 Ruakura Structure Plan – Land use(Appendix 2))
 - The greenway;
 - The area to the north of the proposed Ruakura Industrial Park Zone that adjoins the General Residential Zone;
 - The transmission corridor between Ruakura Road and the Knowledge Zone
 - The area between the realigned Ruakura Road and Silverdale Road, and between the Ruakura Industrial Park Zone and the existing General Residential Zone to the south;
 - The area between the logistics and industrial activities, and the residential neighbourhoods in Silverdale and the University of Waikato.
 - The area between Fairview Downs residential area and the Spine Road.
- y) Neighbourhood reserves – these will be required as part of the subdivision process and the establishment of residential neighbourhoods. As such the location of the neighbourhood reserves on Figure 2-14 Ruakura Structure Plan – Land use (Appendix 2) is indicative only. Each neighbourhood reserve shall be an area of approximately 0.5ha and serve a catchment area of approximately 500m radius. Neighbourhood reserves complement the range of facilities provided by the Ruakura Open Space Zone and provide a focal point for, and contribute to the visual amenity of the local community.
- z) Connectivity – a concept layout plan at Land Development Plan stage will show the location and dimension of pedestrian and cycle ways in accordance with Figure 2-18 Cyclist and Pedestrian Network Plan (Appendix 2) as well as the landscape treatment of streets, footpaths and cycleways.

Ruakura Strategic Infrastructure (as shown on Figures 2-15A and B)

- aa) Consistency with Figures 2-15A and B Ruakura Strategic Infrastructure (Appendix 2) 3.7.2.6 Connections to Ruakura Strategic Infrastructure and 3.7.4.4 Ruakura Strategic Infrastructure Rules, where relevant.

1.2.2.19 Staging and Traffic Requirements

- a) The application shall be accompanied by an Integrated Transport Assessment (ITA) prepared in accordance with Rule 25.14.4.3.
- b) All ITAs required shall be prepared by suitably qualified professionals and should generally follow the approach and guidelines of New Zealand Transport Agency's "Research Report 422: Integrated Transport Assessment Guidelines, November 2010", or its replacement.

1.2.2.20 Concept Plan Consent for Knowledge Zone (excluding Precinct C)

Any application for a Concept Plan Consent for Precinct A, B or D in the Knowledge Zone shall show the total expected development of the facility (even if the development in that area is to proceed in stages) through plans and explanatory text which may include the following information (as relevant).

- a) How the proposal is in general accordance with the urban design approach objectives and policies in Volume 1, Chapter 25.15: City-wide – Urban Design.
- b) Demonstrate how the objectives, policies and rules in Volume 1, Chapter 8: Knowledge Zone have been met.
- c) Demonstrate how the relevant assessment criteria have been met.
- d) Details of any consultation undertaken.
- e) A Concept Plan shall be provided as part of a Concept Plan Consent that shows diagrammatically, in the form of sub areas:
 - i. The general distribution of activities, buildings, open space and parking facilities.
 - ii. Provision for access to and movement within the site for vehicles.
 - iii. Pedestrian and cycle links. Show the position of existing and proposed walkway and cycleway links within the site and to adjacent sites.
 - iv. The interrelationships with the surrounding locality, including buffer areas, links to local centres and access to passenger transport.
 - v. Future development areas, major landscaping areas and protected natural heritage and cultural features.
 - vi. The parameters to which development in different areas will be subject, in terms of the general configuration and bulk of existing and proposed buildings.
 - vii. Development Staging. Explain if development of the precinct is to be staged, the manner and proposed timeframes for the staging (if known) and the means of managing any vacant land during the staging process.

- viii. How Interface Areas on site are being appropriately planned for in the development of Concept Plans as part of a Concept Plan Consent.
- f) Any other information that may be needed to assess the application.
- g) New Concept Plan Consents shall include a Broad ITA in accordance with Rule 25.14.4.3.

Note

A Concept Plan Consent may include a condition which requires the consent holder to submit a detailed building design, prior to construction commencing. This is to ensure quality outcomes for the Knowledge Zone in circumstances where a CPC identifies building envelopes. The matters which may be required to be addressed will be based on Assessment Criteria B – Design and Layout in Appendix 1.3.3.

1.2.2.21 Land Development Consent - Te Awa Lakes Medium-Density Residential Zone

An application under Rule 4.5.6 c) shall be accompanied by a Land Development Plan including the following information. All information shall demonstrate consistency with the Te Awa Lakes Structure Plan.

- a) The boundaries between the Land Development Plan and adjoining Land Development Plan Areas.
- b) The boundaries of any Open Space Zone included in the Land Development Plan.
- c) Where an application for Land Development Consent is made for part of a Land Development Plan Area (as shown on Figure 2-21) pursuant to Rule 4.5.6 b), the following indicative information for the balance area of each Land Development Plan Area shall be provided as part of that application:
 - i. The location of proposed roads and their integration with the existing and future transport networks;
 - ii. The location and size of stormwater treatment and control measures; and
 - iii. The location, size and purpose of open spaces.
- d) The location, width and design of proposed roads and carriageways (including lighting, street furniture and signs), and including measures that achieve safe speed environments, and the integration of roads with the existing and future transport network.
- e) The location and design of stormwater treatment and control measures.
- f) The locations and dimensions of the main linear lake and any relevant components of open space described in 3.8.2.8, in accordance with Figure 2-19 and Rule 3.8.5.4 in Section 3.8 Te Awa Lakes Structure Plan. In addition, for the main linear lake, the details of engineering measures to be implemented at the northern and southern outlets of the lake to ensure a maximum hydraulic gradient of 2% between the linear lake and the Waikato River is maintained at all times. For the avoidance of doubt, any engineering measures required to ensure compliance with this rule shall take precedence over any other engineering provisions in the District Plan and the requirements of the Regional Infrastructure Technical Standards (RITS). The location and dimensions of pedestrian and cycleways including details of how the Land Development Plan has been designed to align with the Walking and Cycling

Network in Figure 2-19 Framework Plan in Section 3.8 Te Awa Lakes Structure Plan and to connect to the walking and cycling paths referred to in clause 3.8.3 in Section 3.8 Te Awa Lakes Structure Plan, including their integration with existing and future pedestrian and cycleways.

- g) Existing and proposed Three Waters infrastructure necessary to service the Land Development Plan Area and in accordance with any relevant Full ICMP. If there is no relevant Full ICMP, prepare and include a sub-catchment ICMP in accordance with Appendix 1.2.2.6.
- h) Existing and proposed ground levels and associated earthworks.
- i) A landscape concept plan, incorporating an indigenous landscape plan, that includes:
 - i. A landscape concept for any areas of open space, including neighbourhood reserves and esplanade reserves.
 - ii. Details of landscape treatment of streets, footpaths and cycleways.
 - iii. Details of landscape treatment of stormwater swales, wetlands, detention basins and lake riparian margins.
 - iv. Details of landscape treatment to provide a buffer adjacent to the Waikato Expressway.
 - v. Details of plant types and species and sizes at time of planting, including eco-sourcing of plants from within the Waikato Basin and choice of species that reflect the history of the area.
 - vi. Details of ongoing maintenance to ensure the planting achieves the best possible growth rates.
 - vii. Use of indigenous plant species and landscape design that reflect cultural perspectives including valued food gathering species and those that support habitat for mahinga kai, native birds and lizards.
 - viii. Details of any interpretation materials communicating the history and significance of places and resources and any tangata whenua inspired artwork or structures.
 - ix. Evidence of consistency with the Ecological Rehabilitation and Management Plan required by Rule 1.2.2.21 k).
 - x. Evidence of engagement with tangata whenua in preparation of the landscape concept plan, including how the outcomes of that engagement have been addressed.
- j) An Ecological Rehabilitation Management Plan (ERMP). The objective of the ERMP is to enhance ecological values where practicable and if not, to avoid, remedy or mitigate potential adverse effects on freshwater and terrestrial ecological values. It is to include the following, and the methods to implement them:
 - i. An indigenous fish management plan, including a summary of fish habitat and species present, a summary of planned works, permitting requirements, procedures for dealing with pest fish, biosecurity protocols, timing of works, procedures for recovering indigenous fish prior to and during works, roles and responsibilities of parties, reporting requirements and any specific mitigation measures.

-
- ii. Planting of trees for bat habitat, including tall tree species such as Kahikatea and Totara, in areas where bat habitat utilisation is likely to be high, except for LDP Areas Q and R, and area X in the Business 6 zone, where smaller species will have less geotechnical risk.
 - iii. Lighting design that is sensitive to bat habitat including minimal lighting in areas close to the Waikato River, avoidance of upward-facing lighting and UV lighting, and avoidance of lighting in wetland and riparian margin areas.
 - iv. Restoration planting to include wetland restoration, habitat enhancement and riparian buffer zones.
 - v. Provision of passage into the main linear recreational lake for indigenous fish if practicable, while excluding exotic pest fish species.
 - vi. Main linear recreational lake bathymetry that is sufficient to help reduce wind-driven sediment resuspension and excessive growth of nuisance weeds.
 - vii. Incorporating diversity into the main linear recreational lake shore habitat including built areas, wetland plants and beach areas.
 - viii. Ensuring sufficient water flow through the main linear lake or other methods to maintain high water quality, having particular regard to avoidance of nuisance phytoplankton blooms.
 - ix. Ensuring new stream habitat mimics natural systems.
 - x. A specific ecological rehabilitation plan to restore and enhance the unnamed tributary to the Waikato River that is the southern stormwater outlet of the site. The stream runs through the adjacent Lot 1 DPS 57602 and Part Lot 1 DPS 11080, and the plan is to apply to its full length and incorporate as a minimum:
 - Creation of a diverse and variable habitat and channel complexity over time to allow for differences in flow velocities.
 - Provision of vegetative cover, woody debris or other in-stream structures.
 - Fish passage by way of lined ramp or similar to enable native climbing species.
 - A meandering channel.
 - Creation of pool-riffle-run sequences.
 - Proposals for ongoing maintenance and management.
 - Avoidance of instream works during peak fish migration periods (August-December)
 - xi. Evidence of engagement with tangata whenua during preparation of the ERMP including how the outcomes of that engagement have been addressed.
- k) Within 200m of the Waikato Expressway carriageway, the layout of roads and lots to generally achieve orientation of habitable rooms in buildings away from the Expressway.
 - l) Within 100m of Hutchinson Road the design of residential dwellings to demonstrate that their main living area outlook and their outdoor living spaces are not orientated to the south.

-
- m) A Water Impact Assessment that demonstrates how the proposal is consistent with the recommendations, measures and targets of the relevant Integrated Catchment Management Plan or Subcatchment Integrated Catchment Management Plan.
- n) A management plan for the main linear lake that has the purpose of achieving a high level of water quality for recreational use with a target of swimmable quality to be achieved to the extent practicable. It is to include:
- A plan for monitoring stormwater inflows and lake water quality to provide sufficient data to adaptively manage the lake to meet a high level of water quality with a target of swimmable quality.
 - A series of triggers and actions, including the use of chlorophyll-*a* as a metric, to maintain high lake water quality.
 - Details of who will be responsible for undertaking the monitoring and any actions to maintain the lake and its water quality.
 - An Operations and Maintenance Manual for the ongoing maintenance of the lake.
- o) The layout of roads, public spaces and lots, showing how the dwelling unit yields in Rule 4.6.2 b) will be achieved.
- p) Building envelopes to demonstrate the suitability of any lots intended for duplex or apartment development.
- q) A Broad Integrated Transport Assessment for anticipated development within the LDP area, prepared in accordance with the requirements of Rule 3.8.5.3 and Appendix 15-2 and assessing the levels of traffic generation to determine the implementation of transport infrastructure improvements and their staging and timing in accordance with clause 3.8.3 and Rule 3.8.3.5 in Section 3.8, Te Awa Lakes Structure Plan. The Integrated Transport Assessment shall include information describing the proposed walking and cycling network, its connections to existing shared paths in the locality and proposals to provide a shared use connection to the Te Rapa area as described in clause 3.8.3 in Section 3.8, Te Awa Lakes Structure Plan. The ITA shall include evidence of consultation with NZTA, AFFCO New Zealand Limited, Fonterra Limited and Ports of Auckland Limited and how the outcomes of that consultation have been addressed.
- r) A Travel Demand Management (TDM) Plan that outlines the measures to be implemented to achieve:
- Leadership of travel demand management by the consent holder;
 - Collaborative participation with Hamilton City Council, Waikato Regional Council, Fonterra Limited, AFFCO New Zealand Limited and the local Te Awa Lakes community;
 - Strong mode shift outcomes to alternative, non-motorised and public transport utilisation;
 - Integration with existing and future public transport outcomes;
 - Multi-modal rideshare alternatives and associated infrastructure;
 - Cycle network integration and enhancement;
 - Pedestrian network integration and enhancement; and

- Minimisation of external private trip making.
- s) In Land Development Plan Areas Q and R, and area X in the Business 6 zone, the following additional information to address geotechnical risk on an ongoing basis, following subdivision and development, is required:
- i. Methods to avoid the establishment or removal of large trees.
 - ii. Methods to avoid on-site stormwater disposal.
 - iii. Methods to avoid directional drilling or trenching below maximum ground water level.
 - iv. Methods to avoid groundwater recharge or extraction.
 - v. Methods to control bedding and backfilling requirements for buried infrastructure.
 - vi. Methods to avoid bulk cut or fill earthworks.
 - vii. Methods to ensure all buildings are subject to specific foundation design, including geotechnical review.
- u) An alligator weed management plan prepared by a suitably qualified person incorporating methods to manage and control alligator weed during construction and on an ongoing basis after subdivision and development. The management plan is to include:
- i. Objectives that focus on eradication of the weed from the site but provide for an adaptive approach of stopping its spread and reducing its density if that proves impracticable.
 - ii. Identification of measures for the safe disposal or removal off site of soil or other material infested with alligator weed.
 - iii. Identification of the need for any of the management and control measures to be implemented on an ongoing basis following subdivision and development, and to be incorporated into conditions of consent and through consent notices.
 - iv. Evidence of consultation with Waikato Regional Council and Hamilton City Council (as asset manager), including how the outcomes of that consultation have been addressed, and a copy of any Weed Hygiene Plan that is in place in accordance with the provisions of the Waikato Regional Pest Management Plan.

Note: *The Te Awa Lakes site contains alligator weed which is defined as a 'progressive containment' pest plant in the Waikato Regional Pest Management Plan. That Plan includes rules that apply to land that is to be subdivided or developed and includes pest plants. The Waikato Regional Pest Management Plan is administered by Waikato Regional Council.*

- v) In Land Development Plan Areas Q and R, and area X in the Business 6 Zone, the following additional information to address residual natural hazard risks resulting from future activities, is required:
- i. Location, extent and form of all existing and proposed:
 - Buildings and structures.
 - Landscaping (including retaining walls and fences) in accordance with the Landscape Concept Plan required by Rule 1.2.2.21 j).

- Sealed and other impermeable ground surfaces.
 - ii. Existing and proposed site contours at 0.5m intervals.
 - iii. Location, extent and species of:
 - Existing vegetation being removed.
 - Existing vegetation being retained.
 - Any proposed new vegetation.
 - iv. The location of vehicle access, manoeuvring and parking areas where relevant.
 - v. The nature of ground conditions and a description of proposed remediation and ground improvement measures.
 - vi. Details of proposed ground surface levels to ensure underground services can be installed sufficiently above ground water levels.
 - vii. Evidence of consultation with underground service providers on required service installation depths and how that information has informed the final ground surface design.
 - viii. Landform design to direct surface water towards the lake rather than the river.
 - ix. Details of the use of any low permeability lining to be placed over the base of services trenches.
 - x. Details of combined services trenches.
 - xi. Specific geotechnical designs of structures.
 - xii. Details of any rainwater reuse tanks and their overflow paths and discharge locations.
 - xiii. Methods to mitigate any land stability, erosion, earthquake (amplification and liquefaction) or any other natural hazards.
 - xiv. An assessment and design to demonstrate how the proposed landform width in LDP Areas Q and R minimises the risk of piping erosion or other ground failure.
 - xv. Any mitigation measures proposed.
 - xvi. Methods for site management of earthworks and stormwater.
- w) In Land Development Plan Areas I and J (the main linear lake), Q and R, and area X in the Business 6 zone, the outcomes of an independent engineering peer review commissioned by the applicant in consultation with Hamilton City Council.

1.2.2.22 Resource Consents - Te Awa Lakes Business 6 Zone

An alligator weed management plan prepared by a suitably-qualified person incorporating methods to manage and control alligator weed during construction and on an ongoing basis after subdivision and development. The management plan is to include:

- i. Objectives that focus on eradication of the weed from the site but provide for an adaptive approach of stopping its spread and reducing its density if that proves impracticable.
- ii. Identification of measures for the safe disposal or removal off site of soil or other material infested with alligator weed.
- iii. Identification of the need for any of the management and control measures to be implemented on an ongoing basis following subdivision and development, and to be incorporated into conditions of consent and through consent notices.
- iv. Evidence of consultation with Waikato Regional Council and Hamilton City Council (as asset manager), including how the outcomes of that consultation have been addressed, and a copy of any Weed Hygiene Plan that is in place in accordance with the provisions of the Waikato Regional Pest Management Plan.

Note: The Te Awa Lakes site contains alligator weed which is defined as a 'progressive containment' pest plant in the Waikato Regional Pest Management Plan. That Plan includes rules that apply to land that is to be subdivided or developed and includes pest plants. The Waikato Regional Pest Management Plan is administered by Waikato Regional Council.

1.2.2.23 Rotokauri North

a) Subdivision of a Duplex

- i) For any restricted discretionary activity subdivision of a permitted activity duplex (which meets Rule 4.7.12(a)), applicants need not provide a site analysis (otherwise provided for in 1.2.2.2 c) above).

b) Any subdivision in Rotokauri North

- i) Identify whether approval of the subdivision consent would exceed a development trigger or upgrade threshold specified in 3.6A.4.2.
- ii) The ability for any proposed lot in a subdivision to comply with the vehicle crossing separation distance requirements in Rule 25.14.4.1a) and 25.14.4.1c) shall be demonstrated.

c) Rotokauri North Ecological Rehabilitation Management Plan (ERMP)

For any subdivision where the footprint of the subdivision area includes land within the 'Green Spine' identified in Appendix 2 Figure 2-8A, and/or land for stormwater management devices to vest not identified on Figure 2-8A an ERMP shall be provided with the application and shall meet the following requirements (to apply to the application footprint of the proposed subdivision only):

- i) The objective of the ERMP is to restore, protect and enhance aquatic and terrestrial ecological values within the site of the existing stream corridor and proposed stormwater treatment wetlands within the Green Spine
- ii) The plan shall incorporate:
 - A. Habitat that mimics natural systems including:
 - Fish passage
 - Diverse and variable habitat and channel complexity over time to allow for differences in flow velocities
 - A meandering channel
 - Pool-riffle-run sequences
 - Woody debris or other in-stream structures

- B. Measures to protect native fish during stream restoration work including but not limited to recovery and holding of fish during works, procedures for dealing with pest fish, permitting requirements, reporting requirements and any specific mitigation measures.
- C. Indigenous wetland and riparian planting, to include the stormwater wetlands, habitat enhancement and riparian buffer zones.
- D. Ongoing maintenance and management.
- E. Evidence of engagement with mana whenua during preparation of the ERMP including how the matters mana whenua raised in that engagement have been addressed.

d) Protected long-tailed bats, indigenous bird and lizard species:

Long-tailed bats, indigenous bird and lizard species regardless of threat status are protected under the Wildlife Act 1953 from killing or injuring. Long-tailed bats are vulnerable to killing and injury while roosting, birds while nesting and lizards during any site clearance that includes habitat where they are present. It is advisable for any subdivision applicant to be aware of their obligations under the Wildlife Act 1953 when clearing land of vegetation and structures.

For any subdivision application in Rotokauri North provide supporting explanation that these requirements have been considered.

e) Kereru Reserve Management Plan (KRMP)

For any subdivision application in Rotokauri North that includes land within the Kereru Reserve Significant Natural Area (SNA) within the subdivision footprint (identified in Appendix 2, Figure 2-8A, as 'Natural Open Space'), a KRMP shall be provided with the application and shall meet the following requirements (to apply to the application footprint of the proposed subdivision only):

- i) The objective of the KRMP is to provide for the protection and enhancement of the vegetation and fauna within Kereru Reserve SNA
- ii) As a minimum, the KRMP is to include the following:
 - A. Proposed management measures including the removal of weed species, pest management and enrichment planting.
 - B. Evidence of engagement with mana whenua during preparation of the KRMP, including how the matters mana whenua raised in that engagement have been addressed.

f) Rotokauri North Landscape Plan – Reserves to Vest

For any subdivision application in Rotokauri North involving a proposal to vest any land for reserve or local purpose access or involving the creation of a landscape buffer against SH39, a Landscape Plan shall be provided with the application and shall meet the following requirements (applying to the application footprint of the proposed subdivision only):

- i). The objectives of the Landscape Plan are to identify opportunities to enhance amenity values and provide for the recreation needs of the community through the provision of public parks and reserves.
- ii. The Landscape Plan shall include:
 - A. Use of indigenous species and landscape design that reflect mana whenua cultural perspectives including species that are valued as customary food or for traditional uses, and those that support

- indigenous biodiversity and provide habitat for mahinga kai, native birds and lizards.
- B. Details of plant species and sizes at time of planting proposed within the subdivision site, including eco-sourcing of plants from within the Hamilton Ecological District and choice of species that reflect the history of the area.
- C. Details of ongoing maintenance to ensure the planting achieves the best possible growth rates.
- D. Details of how the landscape plan will support cultural harvest.
- E. Details of any interpretation materials communicating the history and significance of places and resources and any mana whenua inspired artwork or structures.
- F. Evidence of engagement with mana whenua in preparation of the Landscape Plan, including how the matters mana whenua raised in that engagement have been addressed.
- G. Consistency with the Ecological Rehabilitation and Management Plan and the Keruru Reserve Management Plan
- H. Evidence of consistency with any existing landscape development plan that has been prepared for any other subdivisions within Rotokauri North.
- I. Pedestrian and cycle connections within reserves and to the roading network.
- g) In addition to the Broad ITA content specified in 25.14.4.3 m), any Broad ITA prepared in relation to development within Rotokauri North shall include:
- i. Specific consideration of demand, safety, levels of service and options for mitigation at the following intersections and transport corridors:
- A. Exelby Road / State Highway 39 (SH39) intersection;
- B. Collector 1 / State Highway 39 intersection;
- C. Te Kowhai Road / State Highway 39 / Burbush Road intersection;
- D. Burbush Road; and
- E. Exelby Road between Rotokauri North and the Rotokauri Road / Exelby Road intersection inclusive; and
- F. Exelby Road / Lee Road intersection
- ii. Evidence of the following consultation and responses to the issues raised in that consultation:
- A. Consultation with Waikato District Council on the parts of Exelby Road and Te Kowhai Road that are in that Council's jurisdiction.
- B. Consultation with Waka Kotahi (the New Zealand Transport Agency) regarding the interface with SH39 including any intersections.
- iii. An ITA addressing the intersections listed in clause i shall be provided where the cumulative total of consented lots/units reach 700.

3 Assessment Criteria

1.3.1 Guide to Using the Criteria

This chapter provides a range of Assessment Criteria that are to be used, where relevant, in the assessment of activities that require resource consent.

Specifically:

1. Controlled Activities will be assessed against the matters over which Council has reserved control. The assessment criteria are provided within section 1.3.2 with the section headings being the Matters of Control.
2. Restricted Discretionary Activities that are restricted solely due to failed standards will be assessed against the effects resulting from an activity not complying with any relevant standard(s) in this District Plan (refer section 1.3.3. A1 of this appendix).

To assist with assessing the effects of the non-compliance, there may be specific criteria within section 1.3.3 of this appendix that could be of use in assessing the application.

3. Restricted Discretionary Activities that are restricted solely due to being listed in the chapters as a Restricted Discretionary Activity will be assessed against the specific matters of discretion which are identified against each activity in the chapter.

The headings within section 1.3.3 relate to the Matters of Discretion. The criteria listed under each heading are to be used where relevant. Subheadings are provided under each subject matter to define zone or activity specific criteria for that subject matter, thereby enabling them to be considered or discarded depending on relevance.

4. Restricted Discretionary Activities that are restricted by virtue of being listed in the chapter as a Controlled Activity and also fail standards will be assessed against the relevant criteria as outlined in points 1 & 2 above.
5. Restricted Discretionary Activities that are restricted by virtue of being listed in the chapter as a Restricted Discretionary Activity and also fail standards will be assessed against the relevant criteria as outlined in points 2 and 3 above.
6. Discretionary and Non-Complying Activities may use the criteria in section 1.3.3 as a guide with specific reference to the general criteria in A2.

1.3.2 Controlled Activities – Matters of Control

The following section contains matters over which Council has reserved control for Controlled activities. These are referenced in other parts of the District Plan.

Note

1. Example: chapters in this District Plan may include a section titled “Controlled Activities – Matters of Control” and a table like the example below.

Activity	Matter of Control Reference Number (Refer to Volume 2, Appendix 1.1)
i. Teaching and research laboratories	A. Hazardous Facilities

In this example the controlled activity is “i. Teaching and research laboratories”. The matters of control are identified by the reference “A”. These references align with the lists below. In this example “A” is associated with Hazardous Facilities with the relevant matters of control listed beneath.

A.	Hazardous Facilities
	The extent to which the effects on, and risks to, the health and safety of people, property and the environment are appropriately managed, including:
i.	Matters referred to in the relevant standards in Rule 25.4.4 of Chapter 25.4 City-wide – Hazardous Facilities.
ii.	Safe access to and from the transport network.
iii.	Effects due to the sensitivity of the surrounding natural, human and physical environment.
iv.	Separation distances and the type of environment/number of people potentially at risk from the proposed facility.
v.	Potential hazards and exposure pathways arising from the proposed facility.
vi.	Potential cumulative hazards presented in conjunction with neighbouring facilities.
vii.	Proposed: <ul style="list-style-type: none"> • Fire safety and fire water management • Spill contingency and emergency planning • Monitoring and maintenance schedules • Waste disposal management • Hazardous substance transport arrangements
viii.	Compliance with relevant Standards and Codes of Practice.
ix.	Any other measures to avoid or mitigate risks posed by the activity.
	<p>Note</p> <p>Relevant Standards and Codes of practice referred to above may include:</p> <ul style="list-style-type: none"> • Below Ground Stationary Container Systems for Petroleum – Design and Installation HSNOCOP 44, Environmental Protection Agency, May 2012 • Below Ground Stationary Container Systems for Petroleum – Operation HSNOCOP 45, Environmental Protection Agency, May 2012 • Guidelines for Assessing and Managing Petroleum Hydrocarbon Contaminated Sites in New Zealand, Ministry for the Environment, 1999

	<ul style="list-style-type: none"> • Environmental Guidelines for Water Discharges from Petroleum Industry Sites in New Zealand, Ministry for the Environment, 1998 • NZS8409: 2004 Management of Agrichemicals • AS/NZS 1596: 2008 – Storage and Handling of Liquid Petroleum Gas • AS/NZS 2982: 2010 – Laboratory Design and Construction • AS/NZS 2243.1: 2005 – Safety in Laboratories – Planning and Operational Aspects • AS/NZS 2243.2: 2006 – Safety in Laboratories – Chemical Aspects • AS/NZS 2243.3: 2010 – Safety in Laboratories – Microbiology • AS/NZS 2243.5: 2004 – Safety in Laboratories – Non-ionising Radiation • AS/NZS 2243.6: 2010 – Safety in Laboratories – Plant and Equipment Aspects • AS/NZS 2243.8: 2006 – Safety in Laboratories – Fume Cupboards • AS/NZS 2243.9: 2009 – Safety in Laboratories – Recirculating Fume Cabinets • AS/NZS 2243.10: 2004 – Safety in Laboratories – Storage of Chemicals
B.	Industrial Zone
a)	Building Design, External Appearance and Site Layout
	<p>i. The extent to which any activity involving buildings adjoining an identified transport corridor and buildings within the Rotokauri Employment Area presents an attractive visual appearance, including minimising:</p> <ul style="list-style-type: none"> • Large featureless building façades facing the transport corridor. • The placement of any plant or machinery on the front of the building or within the front yard setback (with the exception of machinery displayed for sale, hire, or plant associated with on-site security). • Over-dominant illuminated signage within the site. • Front fences, walls and signs that detract from an active visual relationship between the site and street/primary transport corridor. • The location of the service and outdoor storage areas within the front setback.
	<p>ii. For ancillary residential activities, the extent to which:</p> <ul style="list-style-type: none"> • Outdoor living areas or balconies are contiguous with the internal living areas. • The design, size and location of the private and/or communal open space, parking, loading spaces and driveways on the site achieves a high standard of amenity, noise and visual privacy for residents, whilst effect from dust, fumes and light glare are minimised.
b)	Site Layout
	<p>iii. Within the Rotokauri Employment Area, the extent to which the adverse effects of the location of buildings, parking areas and outside storage areas minimise their potential impact on the amenity of any adjoining Residential, Special Character or Open Space Zones.</p>
	<p>iv. For ancillary residential activities and within the Rotokauri Employment Area, the extent to which the development has been designed and located so that the potential for reverse sensitivity effects (including noise) is avoided, remedied or mitigated.</p>

	v.	The extent to which the site layout incorporates Crime Prevention Through Environmental Design, to develop a positive relationship with the street and improve passive surveillance.
	vi.	The extent to which landscaping is incorporated within the site layout, to visually reduce the bulk of new development and mitigate adverse visual effects, particularly from the front boundary and those parts of the site visible from public spaces. Note This is particularly important in relation to the setback from the front boundary and those parts of the site visible from public spaces and interfaces along state highways and arterial transport corridors.
	vii.	Within the Rotokauri Employment Area, the extent to which landscaping enhances amenity at key interfaces such as State Highway 1, green corridors, arterial transport corridors, Wintec Rotokauri Campus and the Rotokauri Suburban Centre.
C. Knowledge Zone and Major Facilities Zone		
a) Building Design, External Appearance and Configuration		
	i.	The extent to which the external appearance, scale and design of buildings:
	1.	Contributes to compatibility between buildings and their integration with other development on the site, adjacent sites and surrounding public spaces.
	2.	Contributes to the active frontage along public streets and open space, particularly at corner sites.
	3.	Minimises, as practicable, effects on adjacent public spaces (including footpaths) in terms of shading and daylight.
	ii.	The cumulative effect of buildings and the extent to which opportunities have been taken to cluster buildings and/or ensure that areas are left free from buildings.
	iii.	The extent to which parking, manoeuvring areas, driveways and outdoor service areas are designed and located to be safe and efficient, and to protect amenity values of the streetscape and adjoining sites.
	iv.	The extent to which the building design and development:
	1.	Makes a positive contribution to the local character of the site and surrounding area.
	2.	Improves large façades (including side walls) that are visible from public places by ensuring they are treated in a way that provides visual interest and reduces the apparent bulk of the building.
	v.	The extent to which Crime Prevention Through Environmental Design principles have been incorporated.
	vi.	Encourage easy and safe pedestrian access and circulation for those not arriving by vehicle.
b) Landscaping		

	vii.	The extent to which landscaping is incorporated within the site layout to reduce the bulk of new development and mitigates adverse visual effects. Note This is particularly important in relation to setback from the front boundary and those parts of the site visible from public spaces and interfaces along state highways, arterial transport corridors and City gateways.
In addition to the above general matters, the following relate to site specific matters of control.		
University of Waikato		
	viii.	The extent to which existing linkages between land uses are reinforced by the layout of buildings and transport corridors. New connections created should seek to enhance accessibility through the zone and have regard to connectivity to the adjoining University of Waikato campus.
	ix.	The extent to which high rise buildings are concentrated on the Hillcrest Road ridge.
	x.	The extent to which the location of buildings maintains the safe and efficient operation of network utilities, including high voltage transmission lines.
Knowledge Zone		
	xi.	The extent to which the open space character of the northwest sector of the site is maintained.
Claudlands Event Centre		
	xii.	The extent to which the open space character of the eastern part of the site is maintained including the maintenance of a suitable buffer adjoining Jubilee Park.
Te Rapa Racecourse/Thoroughbred Business Park		
	xiii.	The extent to which development of the site retains views between the racecourse and Minogue Park.
Waikato Hospital		
	xiv.	The extent to which activities of an industrial nature and the heliport are grouped in the south-western sector of the site.
	xv.	The extent to which high rise buildings are concentrated towards the centre of the hospital complex.
Waikato Stadium and Seddon Park		
	xvi.	The extent to which future buildings and the enhancement of facilities including any provision for office, retail and visitor accommodation provides for functional integration with the site.
Wintec Rotokauri		
	xvii.	The extent to which development of the site has regard to the future development of the Rotokauri Area and the relationship of the site with Lake Waiwhakareke.
D.	Te Rapa North Industrial Zone	

a)	Concept Development Consent for Stage 1A	
	i.	The extent to which it identifies the total area not exceeding 30ha available for industrial development within Stage 1A.
	ii.	The extent to which it defines the location and extent of the development area not exceeding 7ha pursuant to Rule 12.6.1.
	iii.	The extent to which it defines the general location and extent of the development area not exceeding 23ha pursuant to Rule 12.6.1.
	iv.	The extent to which it demonstrates connectivity and sequential development between the 7ha and 23ha land release areas and adjacent sites.
	v.	The extent to which it provides an indicative internal road layout and it provides for alternative modes of transport including public transport, pedestrian and cycle linkages within and between the 30ha and adjacent land.
	vi.	The extent to which it considers and responds to the recommendations and proposed conditions of an Integrated Transport Assessment prepared in accordance with Rule 25.14.4.3.
	vii.	The extent to which it specifies methods by which vehicle movements will be managed to achieve compliance with Rule 12.4.7b).
	viii.	The extent to which it identifies any existing indigenous vegetation and areas of ecological value including recognition of existing gully systems and proposals for their management.
	ix.	The extent to which it provides for any landscaping and screen planting including landscaping buffers where land adjoins the Waikato Expressway designation boundary.
	x.	The extent to which it provides a report which demonstrates the extent to which the provision of reticulated infrastructure for the entire 30ha within the Stage 1A development area will occur; provided that existing infrastructure available from the Te Rapa Dairy Manufacturing Site and/or Council infrastructure and headworks (water and wastewater only) may be relied on for the 7ha development under Rule 12.3.3f).
		<p>Note</p> <p>The above does not involve:</p> <ul style="list-style-type: none"> • Activities requiring an air discharge consent under the Regional Plan (except on land situated to the north of Hutchinson Road, east of Te Rapa Road) • Hazardous waste reprocessing, disposal or storage, except for temporary storage of waste from commercial activities awaiting collection • An extractive industry • Offices, except those that are ancillary to industrial uses • Hospitals, day care facilities, and educational institutions • Retail activities, except for food outlets less than 200m² • Residential activities unless associated with a lawfully established activity.
E.	Historic Heritage	
a)	Management of effects on, and risks to the heritage value of the historic heritage building or structure, including:	

	i.	Effects to the exterior of the historic heritage building or structure.
	ii.	Potential loss of the heritage values of the building or structure.
	iii.	Any other measures to avoid or mitigate risks proposed by the activity.
	iv.	Works compatible with and reflect the original fabric of the historic heritage building or structure.
	v.	Earthquake strengthening not detracting from the appearance and integrity of the historic heritage building or structure.
	vi.	Demonstration of the conservation principles of the International Council on Monuments and Sites (ICOMOS) New Zealand.
F.	Ruakura	
a)	Interface Design Control Area	
	Landscaping	
	i.	Ruakura Logistics Zone - Subject to biosecurity requirements, landscaping should be incorporated within the site layout to reduce the bulk of new development and mitigate adverse visual effects. This is particularly important in relation to setbacks from the front boundary and those parts of the site visible from public spaces and interfaces along state highways, arterial transport corridors, and the Ruakura Open Space Zone and City gateways.
	ii.	In relation to the Waikato Expressway, whether landscaping along the boundary with the Expressway Designation is of appropriate scale and density so as to soften views from the Expressway of industrial development.
	iii.	Ruakura Industrial Park Zone – Landscaping and screening should be incorporated within the site layout to reduce the bulk of new buildings and associated development, and to mitigate adverse visual effects - particularly from storage, loading and operational areas likely to be visible from residential areas. This is also important in relation to setbacks from the front boundary and those parts of the site visible from public spaces and interfaces along state highways, arterial transport corridors, and the Ruakura Open Space Zone and city gateways.
	iv.	Ruakura Industrial Park Zone – In relation to buildings and associated development on sites that adjoin the Ruakura Open Space Zone and abutting the northern boundary of properties on Sheridan Street and Nevada Road or are adjacent to Silverdale Road, proposed landscaping and screening is subject to specific assessment and the standards in Rule 25.5.3.1 are to be used as a guide only.
b)	Crime Prevention Through Environmental Design	
	i.	Buildings and the site layout shall be designed to: <ul style="list-style-type: none"> a) Provide surveillance from offices over main access, car parks and the adjacent street. b) Ensure a clear distinction between visitor areas and operational areas. c) Provide direct, legible and well lit visitor routes.

		d) Avoid opportunities for concealment.
c)	Temporary Logistics Activities in Sub Area A	
	i.	Conditions shall be imposed to ensure that the location of buildings associated with logistics is temporary, the future rail spur corridor is not compromised and that buildings and activities do not preclude the future full development of the Inland Port.
d)	Medium Density Residential Zone	
	i.	Impact of building design, external appearance and configuration on the public realm particularly when viewed from the Ruakura Open Space Zone and arterial corridor.
	ii.	Site layout.
	iii.	Landscaping.
	iv.	The extent to which the amenity and safety of future occupiers will be protected.

1.3.3 Restricted Discretionary, Discretionary and Non-Complying Assessment Criteria

The following section contains assessment criteria under subject headings that relate to the 'Matters of Discretion' for Restricted Discretionary activities. These are referenced in other parts of the District Plan.

Note

Example: Chapters in this District Plan may include a section titled "Restricted Discretionary Activity – Matters for Discretion, Assessment Criteria and Non-Notification Rule" and a table like the example below.

Activity Specific	Matter of Discretion and Assessment Criteria Reference Number (Refer to Volume 2, Appendix 1.2)
i. Vegetation clearance	D - Natural character and open space

In this example the restricted discretionary activity is "i. Vegetation clearance". The matters to which discretion has been restricted to are identified by the subject heading of "D - Natural character and open space".

A range of criteria are provided under that heading in this section and where these criteria are relevant they can be used to assess the application. All criteria under the identified subject heading do not need to be assessed, only those relevant to the application.

Discretionary and Non-Complying Activities may use the criteria in this section as a guide, with specific reference to the general criteria in A3.

A	General Criteria	
	Restricted Discretionary Activities due to Performance Standard Non-Compliance	
A1	The effects resulting from an activity not complying with any relevant standard(s) in this District Plan. Guidance on the assessment of effects may be derived from: <ol style="list-style-type: none"> a) Any relevant criteria within section 1.3.3 of this appendix; and b) Any relevant design guidelines contained within this Plan. 	
A2	The extent to which any adverse effects would be offset by benefits to the community or the natural environment.	
	Discretionary & Non-Complying Activities - General Criteria	
A3	Without restricting the exercise of its discretion to grant or refuse consent or impose conditions, the Council shall have regard to the assessment criteria set out below when considering any application under sections 104 and 104B of the Act. Discretionary activities and Non-Complying activities shall be assessed against, but not limited to the following assessment criteria:	
	a)	Assessment against relevant objectives and policies including Chapter 2 Strategic Framework
	b)	The extent to which the proposal is consistent with relevant:
	i.	Standards in this Plan.
	ii.	Assessment Criteria, listed in this plan.

	iii.	Design Guides.
	iv.	Structure Plans.
	v.	Comprehensive Development Consents.
	vi.	Concept Plans or Concept Development Consents.
	vii.	Reserve Management Plans.
	viii.	Iwi or Hapu Management Plans.
	ix.	Waikato River Vision and Strategy.
	x.	Master Plans.
	xi.	Temple View Precincts
B	Design and Layout	
	General	
B1	Whether the proposed building design and / or site layout is consistent with the intent of any relevant design guide in Appendix 1 Section 1.4. Note If an activity is a Restricted Discretionary Activity in relation to Design and Layout matters and there is a relevant design guide, then the activity should seek to address the outcomes sought in the design guide as a priority over relevant criteria in this section. Where an application is for a Concept Plan Consent in the Knowledge Zone, the Design and Layout assessment criteria will focus on building precincts / sub-areas, development and infrastructure layout rather than individual buildings.	
B2	Whether the external appearance, scale and design of buildings and structures:	
	a)	Are consistent with the purpose of the zone, and enhance the character and amenity of the surrounding area, streetscape qualities and adjoining land uses.
	b)	For corner sites, where appropriate, provide active frontages along both elevations.
	c)	Incorporate Crime Prevention Through Environmental Design principles.
B3	The extent to which the proposed design provides or continues to provide for informal surveillance of public spaces within and adjacent to the development by:	
	a)	Locating doors, windows and other openings associated with living and working areas, so that they overlook and interact with public spaces.
	b)	Locating primary entrances to buildings to face the transport corridor frontage, with the main entrance located adjacent to the frontage with the most pedestrian traffic.
B4	The extent to which building design will add visual interest and vitality to the streetscape and avoids large, featureless façades. For example, through articulation of a façade, attention to fenestration and rooflines, the design of verandas and balconies and the careful choice of materials and colour.	
B5	The extent to which parking, manoeuvring areas, driveways and outdoor service areas have been designed and located:	
	a)	To protect amenity values of the streetscape and adjoining sites, including through the use of appropriate screening and landscaping.
	b)	To not be visually dominant.
	c)	To be away from the front of the site and buildings.

	d)	To integrate with adjacent activities and development in terms of the provision of entrances, publicly accessible spaces, verandas, parking, loading areas, access to public transport and pedestrian linkages.
B6		The extent to which the activity, including landscaping, has been designed in a manner that supports and enhances pedestrian and cyclists movements, including access to the transport network and along frontages considered important for shopping or entertainment activities.
		Landscaping and Screening
B7		The extent to which planting and landscaping is used to:
	a)	Establish and maintain a well vegetated environment that is compatible with the zone and existing character.
	b)	Visually reduce the bulk of new development and mitigate adverse visual effects particularly from the front boundary and those parts of the site visible from public spaces.
	c)	Create an attractive environment that maintains safety and amenity for pedestrians.
		Waste Management
B8		The extent to which developments provide for goods handling, storage, waste and recycling areas that are:
	a)	Easily accessible for collection agencies and avoid adverse visual, noise or odour effects.
	b)	Consistent with the amenity values of the site and avoid causing nuisance for neighbouring residential activities.
	c)	Suitable for the demand expected by the activity.
		Business Zones
B9		Whether the proposed building setback adversely affects the use and safety of public spaces, or the continuity of shopping frontages.
B10		Whether development of a site adjoining the riverbank encourages pedestrian access to and facilitates public use and enjoyment of, the promenade and environs of the Waikato River.
B11		In relation to the setbacks from internal boundaries at upper levels (i.e. fourth level and above), the extent to which the proposal minimises shadowing and loss of natural light on existing adjacent buildings by providing adequate separation between the proposed development and any existing residential development.
		Knowledge Zone
B12		The extent to which public spaces and streets have been designed to be accessible and open to the public at all times (except where closed for operational safety or security reasons).
		University of Waikato
B13		The extent to which existing linkages between land uses are reinforced by the layout of buildings and transport corridors. New connections created should enhance accessibility through the zone and have regard to connectivity to the adjoining University of Waikato campus.
B14		The extent to which high rise buildings are concentrated on the Hillcrest Road ridge.

B15	The extent to which the open space character of the northwest sector of the site is maintained.	
Sites Adjoining the Waikato Riverbank		
B16	The extent to which development of a site adjoining the riverbank:	
	a)	Provides a scale and design of any building or structure that maintains or enhances street and reserve areas, the character and amenity, and the heritage or open space values of the adjoining riverbank area.
	b)	Makes provision for building design and configuration, site layout and/or landscaping which enhances the visual and physical relationship with the Waikato River.
	c)	Mitigates the impact of large developments and vehicular oriented activities on the amenity values of the riverbank environment.
Development within a Structure Plan Area		
B17	The extent to which the proposal is consistent with any relevant objectives of any structure plan or could prejudice or foreclose options for future urban development and in particular with the proposals shown on the relevant Structure Plan for the area.	
B18	The extent to which the proposed transport network promotes opportunities to achieve:	
	a)	A legible and logical pattern of development in accordance with the planned transport network identified within the relevant structure plan or the ability to extend existing transport networks, and
	b)	The future transport network within the relevant structure plan area for which more precise design, location and layout has been approved.
B19	The extent to which the proposal takes into account new information or policies (including but not limited to ICMPs) that will result in outcomes that are more beneficial than those shown on the Structure Plan.	
Dairies in General Residential and Special Character Zones		
B20	The extent to which the site can adequately accommodate the dairy, any associated residential activity, parking, planting, service areas and signage, whilst ensuring that the building would not dominate the streetscape.	
C	Character and Amenity	
General		
C1	The extent to which the activity:	
	a)	Makes adequate provision to protect the visual and acoustic privacy of abutting residential and community uses, including through building and site design and hours of operation.
	b)	Is compatible with the location in terms of maintaining and enhancing the character and amenity of the surrounding streetscape and urban form.
	c)	Is able to avoid, remedy or mitigate adverse effects on the existing and foreseeable future amenity of the area, particularly in relation to noise, traffic generation, material deposited on roads, dust, odour and lighting.
Reverse Sensitivity		

C2	The extent to which the development (including residential development) has been designed and located so that the potential for reverse sensitivity effects (including noise) are avoided, remedied or mitigated.	
C2a	In the Te Awa Lakes Medium-Density Residential zone and the Te Awa Lakes Business 6 zone, within 100m of Hutchinson Road, the extent to which the main living area outlook is oriented to the north, away from Hutchinson Road.	
C2b	In the Te Awa Lakes Medium-Density Residential Zone, within 200m of the Waikato Expressway, the extent to which the main living area outlook is oriented away from the Waikato Expressway.	
C2c	In the Te Awa Lakes Medium-Density Residential Zone, and the Te Awa Lakes Business 6 Zone, the extent to which the development (including residential development and visitor accommodation) has been designed so that the potential for reverse sensitivity effects on industrial activities in the wider environment are avoided, remedied or mitigated.	
	Residential Zone	
C3	The extent to which the cumulative effects of a non-residential activity together with other non-residential activities will result in an adverse effect to the residential character of the neighbourhood.	
	Central City & Business Zones	
C4	The extent to which the level of non-retail activity within a shopping frontage would adversely affect the attraction of shoppers and visitors.	
C4a	In Te Awa Lakes Business 6 zone the extent to which the recommendations of an alligator weed management plan in accordance with Rule 1.2.2.22 are to be implemented.	
	Future Urban Zone	
C5	The extent to which the location and siting of effluent storage and disposal can avoid effects to dwellings or adjoining sites.	
C6	The extent to which the rural activity remains the predominant activity on the site.	
C7	The extent to which any intensive farming activity avoids adverse effects of noise, odour, vermin and other potential health hazards or mitigates these through management practices, site layout (placement and orientation), design of buildings, screening and landscaping.	
C8	The measures to be adopted to avoid, remedy or mitigate potential effects on residential activities on the site and adjoining properties.	
	Non-Industrial Activities in the Industrial Zone	
C9	The extent to which the non-industrial activity, within an Industrial Zone, serves the needs of an industrial area and adjoining areas, or is more appropriate to an industrial location than in other areas having regard to the nature of the activity, travel demand characteristics and amenity expectations.	
	Residential activities in Figure 9.3a	
C10	For managed care facilities, retirement villages, and rest homes, the extent to which:	
	a)	The siting, scale, design and layout of buildings ensures compatibility between buildings and their integration with other sensitive development on the site, adjacent sites and surrounding public spaces such as Ashurst Park.

	b)	The design, size and location of the private and/or communal open space, parking, loading spaces and driveways on the site achieves a high standard of on-site amenity, noise and visual privacy for residents, and ensures that effects from dust, fumes and light glare are minimised.
	c)	Outdoor living areas or balconies are contiguous with the internal living areas.
	d)	The location of buildings, window and door placement, parking areas and outside amenity areas avoid reverse sensitivity effects on any adjoining industrial activities.
	e)	Existing linkages between land uses are reinforced by the layout of buildings and their positive interface with the proposed linkage road between Maui Street and Karewa Place.
Subdivision		
C11		The extent to which the proposal is consistent with any relevant design guidance in Appendix 1 Section 1.4.
C12		The extent to which any boundary adjustment would have potential adverse effects on the site or the surrounding area.
C13		Whether the subdivision creates lots that are appropriate for their intended use.
C14		The extent to which subdivision or subsequent building design, including the location of transport corridors and reserves, provides for existing electricity lines and their corridors.
C15		The extent to which the proposal is consistent with objectives of any relevant structure plan or could prejudice or foreclose options for future urban development and in particular with the proposals shown on the relevant Structure Plan for the area.
C16		The extent to which the proposal (including the proposed transport network) promotes opportunities to achieve:
	a)	A legible and logical pattern of development in accordance with the planned transport network identified within the relevant structure plan or the ability to extend existing transport networks, and
	b)	The future transport network within the relevant structure plan area for which more precise design, location and layout has been approved.
Ancillary retailing and offices in the Industrial Zone		
C17		In assessing the suitability for ancillary retail or office activity to expand over the thresholds denoted in the Plan, regard shall be given to the following:
	a)	Whether the ancillary use is integral to the continuing operation of the principal activity on the site.
	b)	Whether the ancillary use remains incidental and subordinate to the principal activity on the site.
	c)	Whether the principal activity continues to be of an industrial character and nature.
Fee simple subdivision of apartment buildings		

C18	The suitability of a fee simple subdivision of either an existing, or an approve land use consented, apartment building, is where:	
	a)	Appropriate provision is made for access, services, open space and car parking.
	b)	Subdivision layout clearly outlines areas of individual ownership and areas of shared rights and interests in common.
	c)	Easements, access lots, covenants or similar legal instruments that manage individual ownership and any shared space or common 'elements' to the subdivision, are provided at time of resource consent application for subdivision.
	d)	Appropriate provision made for infrastructure, particularly where shared between lots or crossing several lots.
	e)	The subdivision layout of the proposed sites does not result in new or increased non-compliance with other city-wide and/or zone rules, and the extent of the non-compliance with an approved resource consent for the apartment development.
D	Natural Character and Open Space	
	General	
D1	The extent to which buildings, earthworks, developments and site layout and clustering:	
	a)	Complements and retains the underlying landform and the legibility of the ridgeline features including views to and from ridgelines, having regard to both immediate and cumulative effects.
	b)	Provides a sufficient area of open space to enable a sense of the underlying landform to be retained.
	c)	Retains and incorporates natural features and established mature and indigenous vegetation into the design.
D2	The extent to which the site for a proposed building or structure integrates with the site features of the open space.	
	Activities Affecting Scheduled Trees or a Significant Natural Area	
D3	The extent to which activities associated with the proposal will:	
	a)	Adversely affect any identified value of the tree.
	b)	Adversely affect the health of the tree.
	c)	Adversely affect any identified value of the Significant Natural Area.
	d)	Adversely affect the health of the Significant Natural Area.
	e)	Cause the loss of habitat that provides a key life-cycle function or the physical disturbance of indigenous species listed as 'threatened' or 'at risk' in the New Zealand Threat Classification Systems Lists.
D4	The extent to which impermeable surfaces adversely affect water quality, and the surrounding watertable.	

D5	The extent to which vegetation removal adversely affects the natural character or landscape value of any lake or wetland and the ability to offset such effects through restoration or enhancement.
D6	The extent to which any earthworks will adversely affect the surrounding water table and water quality and the opportunity to mitigate the loss of water from the site.
D7	The extent to which earthworks exacerbate or contribute to flooding, both on-site and off-site.
D8	Whether the removal of peat soils can be mitigated to protect the surrounding water table.
D9	Where it is clearly impractical to dispose of stormwater to ground the provision of other mitigation measures to maintain the water table and protect water quality.
D10	The extent to which undertaking the activity will enable replacement or enhancement of existing vegetation, natural values, or the improvement of riparian margins.
	Non-emergency Works to, Removal or Transplanting of, a Scheduled Tree
D11	The extent to which the tree is causing serious damage to structures or the tree constitutes a hazard to human health, property and infrastructure.
D12	Whether the tree's chance of survival, in the case of transplanting, is better than in its existing location.
D13	Whether alternative developments avoiding the need to remove the tree(s) have been adequately considered.
	Surface of Water
D14	The extent to which water flows are impeded and the potential for debris to be snagged.
D15	The extent of the effect of the proposal on:
	a) Natural character, ecological values, riparian habitat, recreational values, landscape quality and amenity values of the waterway.
	b) Public access to the waterway and on the surface of water.
	c) Adjacent scheduled historic buildings, structures and sites, significant natural areas and significant trees.
	d) Land-based activities.
	e) Other users of the water body including recreational and other commercial activities.
	f) Health and safety and effects on navigation.
	g) Stirring sediment, transporting weeds and aquatic pests.
	h) Bank erosion.
D16	The extent to which the effects of flow levels of the river have been taken into account. (Events should not take place when the Waikato River is in flood, or in low-flow condition.)
D17	The extent to which the design of a pontoon, jetty or boat ramp allows for the operation of the Waikato Hydro System between the lower and upper operating levels for the System.

Esplanade Reserves and Strips	
D18	Any reduction in the required width of esplanade reserve or strip may be considered where:
a)	Topography or the location of an existing building dictates a practical boundary less than 20m.
b)	Reduction of part is offset with a compensatory increased width elsewhere.
	Note For any stream, the purpose of the reserve can be met by a lesser width but should not be considered less than 4m.
And, whether the varied width of the esplanade reserve or strip is such that:	
c)	There is adequate public access to any river, lake or stream and their margins to enable the public to meet any social, recreational or cultural needs.
d)	The natural habitats of flora and fauna in, on or surrounding the river, lake or stream are not adversely affected.
e)	Any Significant Historic Heritage sites identified in Schedule 8A or 8B of Appendix 8 are protected from encroaching development.
f)	Any adverse impacts on water quality are adequately and efficiently mitigated.
D19	In assessing whether an esplanade strip should be set aside, the Council will consider:
a)	Whether there is a need to retain public access because the opportunity to acquire an esplanade reserve is unlikely to arise.
b)	Whether public benefits can be achieved.
D20	The banks of any river, lake or stream can be adequately and efficiently maintained.
E	Heritage Values and Special Character
	General
E1	The extent to which the proposal, development, excavation or subdivision of a historic heritage site or place:
a)	Is consistent with the identified heritage values, including scale, design, form, style, bulk, height, materials and colour, and retains, protects or enhances the historic context.
b)	Provides for design, layout or location of the activity, including associated building platforms, vehicle access and services on site in a manner that will minimise the disturbance of the site.
c)	Provides for the on-going maintenance of the site to ensure that the site is preserved and that damage does not occur.
d)	In Schedule 8A of Appendix 8 maintains visual linkages between the building or structure and the street.
e)	Is compatible with the reasons for inclusion of the building, structure or site and its significance in Schedules 8A or 8B, of Appendix 8.
f)	Addresses cumulative effects on heritage values.
g)	Considers the irreversibility of an effect (e.g. the loss of unique features)

	h)	Considers the opportunities for remediation and the costs and technical feasibility of remediation.
	i)	Considers the resilience of the heritage feature to change (e.g. the ability of the feature to assimilate change, or the vulnerability of the feature to change).
	j)	Adheres to the conservation principles of International Council on Monuments and Sites (ICOMOS) New Zealand Charter (2010) for the Conservation of Places of Cultural Heritage Value, where applicable.
	k)	Includes consultation with Heritage New Zealand Pouhere Taonga.
	l)	In the event of relocation, has adequately considered whether the relocation is necessary and whether appropriate measures are proposed to ensure any potential adverse effects on heritage values are avoided, remedied or mitigated.
	m)	Incorporates proposed planting, fencing and identification (e.g. signage) sufficient to ensure site recognition.
E2		The extent to which the heritage values of any buildings or places identified in Schedules 8A or 8B of Appendix 8 would be adversely affected by the proposal.
E3		The extent to which the proposal including modification, re-use, renovation or restoration to the building or structure:
	a)	Contributes positively to the character of the surrounding area and maintains the relationship of the building or structure with its setting.
	b)	Will maintain and enhance environmental, social, or cultural effects for the wider community.
	c)	Considers the extent to which the primary façade of a scheduled building is proposed to be altered, and whether the main determinants of the style and character, and the heritage significance, of the building are maintained or restored.
	d)	Ensures new buildings respect the design, scale and materials of any original façade.
E4		The extent to which it is practicable to provide noise insulation to the required standard without compromising the heritage significance and fabric of the building.
E5		The extent to which the addition of an awning would likely detract from the original character of an identified heritage building in Schedule 8A and 8B of Appendix 8.
		Temple View Heritage Area
E6		The extent to which new development or earthworks (including the planting or removal of vegetation and trees) would adversely affect the landscape setting and views of the Temple from Tuhikaramea Road.
E7		The extent to which works to a transport corridor or parking area continue the consistent use of materials and kerb edging used throughout the Heritage Area.
E8		The extent to which provision has been made for the investigation, recording or preservation of any archaeological deposits or features.
		Temple View Character Area
E9		The extent to which development maintains the characteristic setback of buildings from the transport corridor, visibility between the dwelling and the transport corridor

	and high levels of landscaping and permeable surfaces within the front building setback.
E10	The extent to which the proposed development, building, structure, alteration or addition is compatible with the scale, form, style, bulk, height, colour or materials of surrounding buildings or structures within the Temple View Character Area.
E11	Whether removal of any building or structure within Precinct 1, 2 and 4 will affect the gateway appearance of the Temple View Character Area.
E12	The extent to which the generous spacing between single dwellings is maintained.
E13	Whether it has been clearly demonstrated that demolition of any heritage building in Schedule 8A of Appendix 8 is necessary, considering alternatives for the refurbishment or re-use of the building, financial cost and technical feasibility.
E14	Any immediate or cumulative effects of the loss, alteration or removal of any buildings on the overall coherence of the Temple View Character Area.
E15	The extent to which new development or earthworks would adversely affect the landscape setting and views of the Temple View Character Area.
E16	The extent to which new development maintains a coherent character within the Temple View Character Area and, where relevant, integrates with development within the subject Precinct, and any adjacent Precinct.
	Peacocke Special Character Zone
E17	The extent to which provision for effluent and stormwater disposal mitigates any risk of landslip or erosion and avoids adverse effects on water quality as it relates to ground water, the Waikato River, and the Mangakotukutuku gully ecosystem.
E18	The extent to which the proposed development takes into account existing rural activities, the location of existing use building platforms and the proposed arterial transport corridors as shown on the Peacocke structure Plan.
E19	Whether the placement of buildings would facilitate future urban re-subdivision particularly with regards to achieving a cohesive urban layout anticipated by the Peacocke Structure Plan and does not compromise the economic provision of future infrastructure.
E20	The extent to which the development provides for the avoidance of natural hazards.
E21	The extent to which a development could have an adverse effect on the consistency and amenity of the area or the presence of mature vegetation.
E22	Any positive impacts to the neighbourhood or the wider community, including the extent to which the activity might enhance the amenity of the area.
E23	Any cumulative effects from the activity, whether on its own or in combination with other activities in the area.
E24	The extent to which the proposed development is compatible with the intent of the consented Master Plan.
	Rototuna North East Character Zone
E25	The extent to which any proposed development or building is consistent with the development controls for the Rototuna North East Character Zone and responds to the existing landform, including the extent to which it avoids excessive earthworks including significant cutting and filling, and does not adversely affect the natural

	topography, the construction or operation of the Waikato Expressway (Designation E90) or Council infrastructure.	
E26	The extent to which the development is compatible with the landform and size of the site, having regard to the intended open space and character of the area.	
E27	The relationship between the scale of any buildings on the site and existing residential development, having regard to the intended character of the area.	
E28	The extent to which the subdivision creates a block pattern with lots fronting streets and backing onto the rear of other lots, addressing the natural landform of the area and on the steeper land, the shape factor circle is located to the front of the sites with low gradients to facilitate building development and access, transitioning the slope to the steeper areas to the rear of the site.	
E29	The extent of any positive impacts to the neighbourhood or the wider community, including the extent to which the activity might enhance the amenity of the area.	
E30	The extent to which the design of the dwelling or building within the 65m setback from the Waikato Expressway (Designation 90) considers effects from the Waikato Expressway, particularly:	
	i.	The extent of a reasonable internal noise environment
	ii.	The siting of any principal outdoor living area to mitigate future traffic noise
	iii.	The extent of any acoustic mitigation to new buildings or additions for habitable uses to mitigate noise.
E31	The extent to which any principal outdoor living area within the 65m setback from the Waikato Expressway (Designation 90) is sited to mitigate the traffic noise of the future Waikato Expressway, including whether it is located to the north of the dwelling to utilise noise attenuation provided by the building form.	
E32	The extent to which the acoustic mitigation of new residential buildings or additions to existing residential buildings for habitable uses will result in mitigating any noise issues generated from the operation of the Waikato Expressway (Designation 90).	
	Railway Park	
E33	The extent to which any new building or additions or alterations to an existing building in Railway Park (Lot 1 DP S37471) is compatible with the material, form and design of the surrounding residential development and existing buildings within Railway Park, in particular the Frankton Junction NZ Railways Institute Hall (Refer to Appendix 8, Schedule 8A, H44).	
F	Hazards and Safety	
	General	
F1	The extent to which the size, location and design of the proposed building, infrastructure, structures, stored goods and materials, fences or walls:	
	a)	Affects the scale, location and orientation of any overland flow path.
	b)	Provides for sufficient permeability:
	i.	So as not to obstruct any overland flow, and
	ii.	To mitigate the likelihood of debris becoming trapped.
	c)	Has sufficient height clearance to mitigate the risk of being affected by inundation.

	d)	Has the structural integrity to withstand inundation.
F2	The extent to which an appropriate building platform can be provided free from any identified hazard area.	
F3	The extent to which the applicant has demonstrated, through the use of an engineering design report:	
	a)	That the risk of ground failure can be reduced to avoid the effects on the safety of occupiers and neighbours.
	b)	That any structure will perform safely under hazard conditions for the life of the structure.
	c)	That any work to be carried out maintains the stability of the river bank or gully and does not increase the risk of ground instability on the subject site or adjacent sites.
F4	The extent to which a flood risk assessment report submitted, with the proposal, contains recommended refinements to the extent of any Flood Hazard Area as a result of additional flood hazard modelling or site specific topographical analysis.	
	Earthworks	
F5	The extent to which the earthworks:	
	a)	Will obstruct or provide overland flow paths or natural surface ponding areas.
	b)	Are managed, designed and constructed to:
	i.	Provide any sediment control measures necessary to control the discharge of sediments.
	ii.	Remain safe and stable for the duration of the intended land use.
	iii.	Provide safe and accessible building sites and infrastructure.
	iv.	Provide for the adequate control of stormwater, cater for natural groundwater flows, and avoid adverse effects from changes to natural water flows and established drainage paths.
	v.	Avoid exacerbating the effects of natural hazards and ecological effects arising from additional sediment release.
	Hazardous Facilities	
F6	The extent to which the proposed site design, construction and operation of a hazardous facility are appropriate to:	
	a)	Avoid the accidental release, or loss of control, of hazardous substances, and whether adequate emergency and spill contingency plans are provided; and
	b)	Avoid and mitigate any adverse effects resulting from activities on the site involving hazardous substances on people, property and environmentally sensitive areas.
F7	The extent to which off-site transport of hazardous substances has been adequately addressed, and the extent to which vehicles transporting hazardous substances use appropriate routes and do not use local transport corridors in residential areas.	
F8	The extent to which the waste management plan adequately addresses the management of significant quantities of wastes containing hazardous substances, including procedures for disposal practices and use of waste contractors.	

F9	Where appropriate, the extent to which alternative locations have been considered adequately.
F10	The extent to which the risks presented by the hazardous facility to humans, the environment and property have been assessed fully and systematically, and whether they are able to be avoided or minimised satisfactorily.
	Nuisance and Health
F11	The extent to which industrial activities giving rise to nuisance can be adequately managed or sited so as to reduce the impact on neighbouring sites.
F12	The extent to which noise effects have been addressed in a noise management plan, including the location of specific noise generating activities, hours of amplified sound and the potential mitigation proposed.
F13	The extent to which the activity may have adverse effects on the environment including water discharges, air pollution, noise and other emissions.
F14	The extent to which any habitable rooms are located, oriented or designed in such a way that would make noise insulation to the required standards unnecessary.
G	Transportation
	General
G1	The extent to which the proposal:
	a) Integrates with, and minimises adverse effects on the safe and efficient functioning of the transport network and infrastructure.
	b) Minimises conflicts between users both within the site and any adjoining transport corridor.
	c) Encourages easy and safe access and circulation for those not arriving by vehicle.
	d) Provides for the accessibility needs of all users of the site.
	e) Provides convenient and safe circulation for connections and/or the provision of facilities for passenger transport modes of travel relative to the scale of the proposal.
	f) Provides for integration with neighbouring activities to reduce the need for separate traffic movements on the transport network.
	Note Acceptable means of compliance for the provision, design and construction of infrastructure is contained within the Hamilton City Infrastructure Technical Specifications.
G2	The extent to which the proposal and the traffic (including nature and type of the traffic, volume and peak flows, travel routes) generated by the proposal:
	a) Requires improvements, modifications or alterations to the transport network and infrastructure to mitigate its effects.
	b) Achieves efficient connectivity and accessibility of transport corridors, pedestrian accessways, cycleways, public reserves and green corridors.
	c) Adversely affects the streetscape amenity, particularly in relation to sensitive land use environments (e.g. residential land use environments identified within Table 15-4a of Appendix 15).

	Integrated Transport Assessment	
	Note	
	In addition to the specific ITA criteria outlined in G3 to G6 below, the balance of criteria contained within Section G may be used to assess a simple or broad ITA where considered relevant.	
G3	The extent to which the proposal considers and responds to:	
	a)	The issues, opportunities and shared outcomes in the Access Hamilton Strategy and its associated Action Plans.
	b)	Relevant:
	i.	New Zealand Transport Agency guidelines
	ii.	Kiwirail guidelines
	iii.	Regional and national transport and growth strategies
	c)	The recommendations and proposed conditions of any integrated transport assessment prepared to accompany the application.
	d)	Issues and outcomes arising from consultation with the relevant road controlling authorities and/or Kiwirail.
G4	The extent to which the proposal incorporates travel demand management and is well-located to be served by passenger transport, or encourages other active modes of travel such as walking or cycling.	
G5	The extent to which an integrated transport assessment assesses how the proposal and any mitigation measures ensure that the safety and efficiency of the transport network is maintained or enhanced.	
G6	Whether access restrictions, auxiliary lanes or other measures are necessary to provide for the safe and efficient operation of key transport corridors such as:	
	a)	Major arterial transport corridors
	b)	Transport corridors that are part of the Strategic Network
	c)	Transport corridors carrying more than 20,000 vehicles per day or with four or more vehicle lanes.
G6a	Provision of safe walking and cycling connectivity between the Waikato Expressway and the Te Awa Lakes Structure Plan area.	
	Access	
G7	The extent to which the proposal minimises the number of vehicle access points to transport corridors, taking into account:	
	a)	Opportunities that exist for shared access with adjoining sites.
	b)	The hierarchy of the fronting transport corridor and opportunities that exist for access to transport corridors of a lower status (e.g. collector or local transport corridors or service lanes).
	c)	Traffic generated by the proposal.

	d)	The siting of the access points with respect to adjacent access points, visibility and flow.
	e)	The operational requirements of the proposal.
	f)	Potential obstruction for access to network utilities.
	g)	The appropriateness of restricting types of movements (e.g. left in/out only, entry or exit only).
	h)	The impact of multiple vehicle entrances (which break up berm, landscaping, footpath and cycleway continuity) on streetscape amenity, retail frontage areas and pedestrian and cycle movements.
	i)	The cumulative effects on traffic safety and efficiency from multiple vehicular accesses on to major arterial routes and whether this can be adequately addressed.
	Parking	
G8	Except in the Central City Zone where there are no minimum parking standards, the extent to which the proposal provides for anticipated parking demand to meet current and future needs.	
G9	In assessing a lesser number of parking spaces and the adequacy of end-of-journey facilities, regard may be had for the following:	
	a)	The anticipated parking demand generated by the proposal including typical operating and peak conditions. Where it can be demonstrated that this is less than the number of spaces required by the standard a lesser number of parking spaces may be accepted.
	b)	The hours of operation relative to other activities on the site or on adjoining sites and opportunities for sharing parking spaces.
	c)	The ability and appropriateness of adjacent transport corridors being used to accommodate on-road parking, particularly in regard to the safe and efficient operation of the transport network and the protection of local character.
	d)	The availability of appropriate off-road public parking in the locality.
	e)	Options for providing additional parking if required in the future.
	f)	The extent to which the provision of end-of-journey facilities, such as bicycle parking, showers, changing rooms and lockers are provided.
	g)	The extent to which provision for active modes of transport or travel planning has been made.
	h)	The availability of passenger transport services in the locality, the proximity of the proposed activity to passenger transport stops and the extent to which those passenger transport services are suited to providing for the transport needs of the proposed activity.
G10	In assessing whether the parking demand for a particular proposal may be provided on other sites, regard shall be given to the following:	
	a)	Whether off site parking is in close proximity with clear, safe and convenient access.
	b)	Whether shared parking provision is acceptable particularly where hours of operation are different.

	c)	The desirability of avoiding vehicular access to the site because of the effects on traffic safety or pedestrian amenity.
	d)	The convenience and safety of those using the parking spaces especially the general public.
	e)	Any arrangement for alternative parking provision is adequately secured by a legally binding mechanism.
	f)	The extent to which the safe and efficient functioning of the transport corridor is affected.
New Transport Corridor Design		
G11		The extent to which transport corridor design provides design elements identified in or otherwise contrary to any criteria contained in Table 15-6a of Appendix 15.
G12		The extent to which the transport corridor design meets the traffic needs of the area and the wider transport network, taking into account the function of the corridor in the transport corridor hierarchy.
G13		The extent to which the width and alignment of the transport corridor is sufficient to accommodate, in a safe and efficient manner, the volume and type of traffic likely to use it, including service and emergency vehicles and heavy vehicles.
G14		The adequacy of provision for the movement of pedestrians, cyclists, physically impaired and transport disadvantaged and any implications for their safety.
G15		The adequacy of provision within the transport corridor for parking spaces relative to existing and potential developments on adjoining land.
G16		The extent to which the extension to an existing, new or an upgraded transport corridor 'matches' the rest of the existing transport network (e.g. levels, design, construction).
G17		The extent to which the design of the road allows for easy installation and maintenance of non-transport infrastructure and amenity tree planting.
G18		The extent to which the design of the transport corridor recognises the character and amenity values of the adjacent land use.
Note In considering the above matters Council may have regard to relevant parts of Austroads Design Guides and NZS 4404:2010 Land Development and Subdivision Infrastructure, and the Hamilton City Infrastructure Technical Specifications.		
H	Functionality, Vitality and Amenity of Centres	
H1	The extent to which the proposed retail or office activity (having regard to its size, composition and characteristics), in conjunction with other established or consented retail or office activity:	
	a)	Avoids adverse effects on the vitality, function and amenity of the Central City and sub-regional centres that go beyond those effects ordinarily associated with competition on trade competitors.
	b)	Avoids the inefficient use of existing physical resources and promotes a compact urban form.
	c)	Promotes the efficient use of existing and planned public and private investment in infrastructure.

	d)	Reinforces the primacy of the Central City and the functions of other centres in the business hierarchy.
H2	Whether and to what extent the proposed Supermarket activity in the Industrial, Business 1 or 4 zones:	
	a)	Avoids adverse effects on the vitality, function and amenity of the Central City and sub-regional centres that go beyond those effects ordinarily associated with competition on trade competitors.
	b)	Avoids the inefficient use of existing physical resources and promotes a compact urban form.
	c)	Promotes the efficient use of existing and planned public and private investment in infrastructure.
	d)	Is located within a catchment where suitable land is not available within the business centres.
	e)	Reinforces the primacy of the Central City and does not undermine the role and function of other centres within the business hierarchy where they are within the same catchment as the proposed supermarket.
I	Network Utilities and Transmission	
	Network Utilities	
I1	The extent to which alternative technologies and techniques have been considered.	
I2	The extent to which co-location of overhead electricity and telecommunication lines is technically, economically and practically reasonable.	
I3	The extent to which the proposal is in accordance with relevant industry standards and meets specified clearance requirements for operational and safety reasons.	
I4	The extent to which the proposal will adversely affect the amenity values of the site and locality.	
I5	The extent to which there are difficult ground conditions, topography or obstructions which make undergrounding impractical.	
I6	The extent to which it is necessary for the proposed site to provide and maintain essential network utility services.	
	Electricity Transmission	
I7	The extent to which the location, height, scale, orientation and use of buildings and structures is appropriate to manage the following effects.	
	a)	The risk to the structural integrity of the transmission line.
	b)	The effects on the ability of the transmission line owner to access, operate, maintain and upgrade the transmission network.
	c)	The risk of electrical hazards affecting public or individual safety, and risk of property damage.
	d)	The extent of earthworks required, and use of mobile machinery near transmission lines, which may put the line at risk.
	e)	Minimising adverse effects including reverse sensitivity, visual and nuisance effects and from transmission lines.

	Note Consultation with Transpower New Zealand Ltd (or its successor) is advised when considering construction within Transmission Corridors A or B. The New Zealand Electrical Code of Practice NZECP: 34 contain restrictions on the location of structures in relation to lines.
I8	The extent of separation between specified building envelopes and existing lines ensures any adverse effects on and from the Electricity Transmission network and on public safety are appropriately avoided, remedied or mitigated.
I9	The extent of separation between the location of any proposed trees and existing lines, taking into account:
	a) The likely mature height of the trees,
	b) Whether they have potential to interfere with the lines, and
	c) Whether an alternative location for the trees would be more suitable to meet the operational requirements of the lines' owner.
	Note All trees/vegetation planted in the transmission corridor must achieve compliance with the Electricity (Hazards from Trees) Regulations 2003.
I10	The extent to which appropriate safeguards are in place to avoid contact or flashovers from lines, and effects on the stability of support structures.
	Note All earthworks, including the use of mobile plant, must comply with the requirements of the New Zealand Electrical Code of Practice 34:2001 (NZECP34:2001).
I11	The extent to which the design of the subdivision, any earthworks and the construction of any subsequent buildings will comply with the safe separation distance requirements in NZECP34:2001.
J	Three Waters Capacity and Techniques
J1	The extent to which the proposal:
	a) Can be adequately serviced by capacity within existing Three Waters infrastructure, including access to and use of an appropriate and sustainable water source.
	b) Can dispose of stormwater and wastewater without adversely affecting the surrounding environment.
J2	Whether the servicing needs of the proposal would necessitate additional public investment in Three Waters infrastructure, services or amenities.
	Note Information requirements relating to WIA or ICMP applications are outlined in Volume 2, Appendix 1.2.
J3	The extent to which the proposal is consistent with the provisions of any Integrated Catchment Management Plan (ICMP) relevant to the site and a consideration of consent conditions imposed in order to achieve that consistency.
J4	Where there is no ICMP, the extent to which the proposal incorporates sustainable management techniques and controls to:
	a) Protect water quality.
	b) Protect the integrity and health of any water courses.
	c) Maintain land stability.

	d)	Limit erosion and sedimentation.
	e)	Limit water wastage.
	f)	Limit the generation of stormwater and wastewater.
	g)	Limit water usage.
J5		Where there is no ICMP, for all new industrial and commercial users with a requirement for high volumes and pressures, the extent to which onsite water storage is provided.
J6		Where there is no ICMP, for development that will create a trade waste discharge:
	a)	The extent to which suitable and safe practices will be employed.
	b)	The extent to which such waste can be treated or pre-treated onsite to improve the quality of the waste or decrease the amount of the waste, prior to any discharge to the municipal wastewater treatment network.
J7		Where there is no ICMP, the extent to which any physical works associated with the proposal affects stormwater storage and retention and whether an equivalent capacity is restored at the completion of works.
K		Major Facility Concept Development Consent Consistency
		General
K1		The extent to which the proposal is consistent with the approved Concept Development Consent for the Major Facility.
		Concept Development Consent
K2		The extent to which the preparation of a Concept Development Consent or an update to an existing Concept Development Consent has given regard to the following.
	a)	The extent to which the major facility integrates with surrounding land uses and transport network.
	b)	The extent to which the development has been designed to minimise, as far as practicable, any adverse effects on adjoining activities, particularly residential activities.
	c)	The extent to which any large façades (including side walls) that are visible from public places have been modulated, articulated, detailed or visually treated in a way that reduces the apparent bulk of the building or provides visual interest.
	d)	The extent to which the proximity of facilities intended to accommodate events are sited close to residential areas.
	e)	The extent to which the provision for vehicular and pedestrian access and circulation facilitates ready dispersal of vehicles and patrons from large events.
	f)	The extent to which provision for vehicular and pedestrian access and circulation prioritises pedestrian safety.
	g)	The extent to which appropriate, convenient provisions enable public transport to service the site, recognising the need for such services to directly access the Central City area.
	h)	The extent to which signage is directed primarily at the patrons attending the venues and television audiences and the extent to which visibility is limited

		from any public space or near-by site, with the exception of signage associated with the naming of the major facility and signs that advertise coming events.
	i)	The extent to which the adverse effects of earthworks are managed.
K3		The extent to which the following have been applied as part of a new Concept Development Consent, an update to an existing Concept Development Consent or in the absence of a Concept Development Consent within the Interface Areas of all Major Facility Sites.
	a)	Built Form and Layout
	i.	The extent to which the external appearance, scale and design of buildings <ul style="list-style-type: none"> • Contributes to compatibility between buildings and its integration with other development on the site, adjacent sites and surrounding public spaces • Contributes to active frontage along public streets and open space, particularly for corner sites • Minimises, as practicable, effects on adjacent public spaces (including footpaths) in terms of shading and daylight.
	ii.	The extent to which building design and development <ul style="list-style-type: none"> • Makes a positive contribution to the local character of the site and surrounding areas • Ensures large façades are well designed to provide visual interest and reduce the apparent bulk of buildings within the Interface Area.
	iii.	The extent to which Crime Prevention Through Environmental Design principles have been incorporated.
	b)	Landscaping
	i.	Incorporation of landscaping within the site layout to reduce the bulk of new development and mitigate adverse visual effects of development within the Interface Area, particularly as they interact with public spaces.
	ii.	Incorporates landscaping to maintain and enhance the character and amenity of the site and surrounding areas.
		Claudelands Events Centre
K4		The extent to which the open space character of the eastern part of the site is maintained and in particular whether a suitable buffer is provided adjoining Jubilee Park.
		Te Rapa Racecourse
K5		The extent to which development of the site retains views between the racecourse and Minogue Park.
		Waikato Hospital Complex
K6		The extent to which activities of an industrial nature and the heliport are grouped in the south-western sector of the site.
K7		The extent to which high rise buildings are concentrated towards the centre of the hospital complex.
		Waikato Stadium and Seddon Park

K8	The extent to which future buildings and the enhancement of facilities, including any provision for office, retail and visitor accommodation, ensure a high degree of functional integration within the site.
K9	The extent to which security fencing is unobtrusive and maintains views of the Stadia grounds from surrounding streets, accepting that no views will be available of the principal playing surfaces and that the Stadia need to ensure the security of the venues as 'charge grounds'.
K10	The extent to which the bulk and location of additional buildings at Waikato Stadium and Seddon Park has been designed and constructed to minimise the extent and duration of shading cast over residential sites.
K11	The extent to which the design and appearance of any replacement grandstand or a substantial alteration to an existing grandstand aims to create an enduring statement and identity, which reflects the pre-eminent role of these sites in hosting international events. Additionally, the extent to which recognition is provided for the cultural heritage of the Whatanoa Gateway.
K12	The extent to which the Mill Street frontage of the Waikato Stadium, including the Mill Street Field, is maintained as open space to continue the historical association with the West Town Belt, providing an attractive vista, enhancing links with the Central City area and the Stadium building.
K13	The extent to which development and landscaping proposals provide for the retention of the existing Kahikatea trees on the Seddon Road frontage of the Waikato stadium and the existing mature trees on the Norton Road and Tristram Street frontages of Seddon Park.
	Wintec Rotokauri Campus
K14	The extent to which development of the site has regard to the future development of the Rotokauri Area and the relationship of the site with Lake Waiwhakareke and the Rotokauri Suburban Centre.
K15	The extent to which farming activities are adequately buffered from neighbouring Residential or Special Character Zones.
	Te Awa Lakes Adventure Park
K16	The extent to which implementation of the management plan required under Appendix 1.2.2.14 h will maintain the water quality in the cable ski lake, and other water features involving swimming, to a standard appropriate to their use.
K17	The extent to which the noise effects of activities are avoided, remedied or mitigated, including through: <ul style="list-style-type: none"> • Management practices • Site layout (location and orientation) • Design of buildings and screening • Hours of operation • Lower noise producing equipment and methods have been investigated and incorporated.
K18	The extent to which the recommendations of any alligator weed management plan are to be implemented.

K19	The extent to which the design and layout of activities and structures and the provision of landscaping and other screening avoids distraction to road users on the Waikato Expressway and Te Rapa Road.	
L	Central City – Design and Layout	
L1	The extent to which the streetscape appearance, scale and design of the building (including material and colour):	
	a)	Will add visual interest and vitality to the streetscape and avoids large, featureless façades. For example, through articulation of a façade, attention to fenestration and rooflines, the design of verandas including continuity with adjoining buildings, the design of balconies and the careful choice of materials and colour.
	b)	Will, where practicable, enable informal surveillance of public spaces including streets, parks, plazas and through-site links.
	c)	Are compatible with heritage or open space values of the Riverfront Overlay area and adjoining riverbank area, where sites are within those areas.
	d)	Activates the site frontage on sites adjoining a defined Primary or Secondary Active Frontage (Volume 2, Appendix 5, Figure 5-7).
	e)	Enhances the experience of the Waikato riverside and Garden Place, where sites are adjacent.
	f)	Enhance those parts of a site adjoining a defined view and vista on Figure 5-6 (Volume 2, Appendix 5).
	g)	Enhance the visual amenity of sites identified as Key Development Sites on Figure 5-7, or Pedestrian Connections and Gateway locations identified on Figure 5-4 (Volume 2, Appendix 5).
	h)	Will, where practicable, provide for public entrances to be on frontages with the highest pedestrian traffic.
L2	The extent to which any proposed building setback will adversely affect the definition, use or safety of public spaces, or the continuity of defined primary or secondary active frontages (Volume 2, Appendix 5, Figure 5-7).	
L3	The extent to which the addition of an awning would detract from the original character of an identified heritage building in Schedule 8A and 8B of Appendix 8.	
L4	The extent to which the proposed building design and/or site layout is consistent with the intent of any relevant design guide in Appendix 1, Section 1.4. Note If an activity is a Restricted Discretionary Activity in relation to Design and Layout matters and there is a relevant design guide, then the activity should seek to address the outcomes sought in the design guide as a priority over relevant criteria in this section.	
L5	The extent to which the external appearance, scale and design of buildings and structures:	
	a)	Enhance the character and amenity of the surrounding area and streetscape qualities.
	b)	Incorporate Crime Prevention Through Environmental Design principles.

L6	The extent to which parking, manoeuvring areas, driveways and outdoor service areas have been designed and located:	
	a)	To protect amenity values of the streetscape and adjoining sites, including through the use of appropriate screening and landscaping.
	b)	To not be visually dominant.
	c)	Where appropriate, to integrate with adjacent activities and development in terms of the provision of entrances, publicly accessible spaces, verandas, parking, loading areas, access to public transport and pedestrian linkages.
L7	Where opportunity is available, and it is practicable, the extent to which any proposal provides or enhances pedestrian and cycle connectivity between streets and other public areas.	
L8	Where required, the extent to which planting and landscaping is used to:	
	a)	Visually reduce the bulk of new development and mitigate adverse visual effects particularly from the front boundary and those parts of the site visible from public spaces.
	b)	Create an attractive environment that maintains safety and amenity for pedestrians.
L9	The extent to which developments provide for goods handling, storage, waste and recycling areas that are located and designed to minimise adverse effects.	
L10	The extent to which development encourages pedestrian access to, and facilitates public use and enjoyment of, the promenade and environs of the Waikato River.	
L11	On those identified streets (Volume 2, Appendix 5, Figure 5-3) the extent to which a proposed street wall or alternative design elements of any proposed building frontage will:	
	a)	Provide consistency in built form and scale with adjoining built form.
	b)	Maintain a human scale when perceived from the street level.
	c)	Maintain sunlight penetration at street level, particularly footpaths.
L12	In relation to the setbacks from internal boundaries at upper levels (i.e. fourth level and above), the extent to which the proposal minimises shadowing and loss of natural light on existing adjacent residential buildings.	
L13	The extent to which development of a site adjoining the riverbank:	
	a)	Provides a scale and design of any building or structure that maintains or enhances street and reserve areas, the character and amenity, and the heritage or open space values of the adjoining riverbank area.
	b)	Makes provision for building design and configuration, site layout and/or landscaping which enhances the visual and physical relationship with the Waikato River.
	c)	Mitigates the impact of large developments and vehicular oriented activities on the amenity values of the riverbank environment.
M	Drive-through Services (Business Zones and Central City Zone - City Living Precinct only), Building Improvement Centre (Business 3 and 5 Zones) and Supermarkets (Central City, Business and Industrial Zones)	

Design and Layout	
M1	The extent to which the external appearance, scale and design of buildings (including material and colour), equipment and structures:
a)	Provide visual interest through a variety of styles and forms in terms of footprint, design and height.
b)	Maintain streetscape amenity and continuity of built form.
c)	Within the Central City Zone, whether any proposed building setback will adversely affect the definition, use or safety of public spaces, or the continuity of defined primary or secondary active frontages (Volume 2, Appendix 5, Figure 5-7).
M2	The extent to which parking, manoeuvring areas, driveways and outdoor service areas have been designed and located:
a)	To appropriately manage any adverse effects resulting from the location and interrelationship between these areas on streetscape amenity.
b)	To ensure traffic generation avoids, remedies or mitigates adverse effects on amenity values.
c)	So as not to compromise the safe use of the footpath adjacent to the site.
d)	To integrate with adjacent activities and development in terms of the provision of entrances, publicly accessible spaces, parking, loading areas, access to public transport and pedestrian linkages.
Landscaping and Screening	
M3	The extent to which planting and landscaping is used to:
a)	Mitigate adverse visual effects particularly from the front boundary and those parts of the site visible from public spaces and interfaces along state highways, arterial transport corridors and City gateways.
b)	Create an attractive environment that maintains safety and amenity for pedestrians.
Waste Management	
M4	The extent to which developments provide for goods handling, storage, waste and recycling areas that are:
a)	Easily accessible for collection agencies and avoid adverse visual, noise or odour effects.
b)	Consistent with the amenity values of the site and avoid causing nuisance for neighbouring residential activities.
c)	Suitable for the demand expected by the activity.
Character and Amenity	
M5	The extent to which the activity makes adequate provision to protect the visual and acoustic privacy of abutting sites including through building and site design.
M6	Considering whether the relationship of buildings and their associated parking, storage and service areas to the street helps to maintain the amenity values of public spaces and streets.

M7	The extent to which any parking or service area is provided, landscaped, screened and maintained in a form which mitigates any adverse effects to adjacent activities and does not detract from the streetscape.	
	Drive-through Services	
M8	For the purpose of assessing the above criteria, regard shall be had to the following operational and functional requirements:	
	a)	The drive-through lane is an integral feature of the site layout.
	b)	Customer car parking access is preferably distinct from drive-through lanes.
	c)	Adequate and accessible servicing areas that are preferably separated from customer vehicle traffic, drive-through lanes and pedestrian movements.
	Building Improvement Centres	
M9	For the purpose of assessing the above criteria, regard shall be had to the following operational and functional requirements:	
	a)	Where large-format building formats are required, there is provision for some solid façades to facilitate internal racking of bulky products.
	b)	The provision of appropriate customer car parking, which is clearly visible from the local road network.
	c)	Adequate and accessible servicing areas that are preferably separated from customer vehicle traffic, timber trade sales access and pedestrian movements.
	Supermarkets	
M10	For the purpose of assessing the above criteria, regard shall be had to the following operational and functional requirements:	
	a)	Store visibility that is easily identifiable when viewed from the street and surrounding area.
	b)	The provision of appropriate customer car parking, which is clearly visible and accessible to motorists approaching the store from the local roading network and to customers on-site.
	c)	Where large-format building formats are required, there is provision for some solid façades to facilitate internal shelving and fresh produce display.
	d)	Adequate and accessible servicing areas that are preferably separated from customer vehicle traffic and pedestrian movements.
N	Ruakura and Te Awa Lakes	
N1	Land Development Plans	
	In determining the application for resource consent for a restricted discretionary activity, Council shall reserve its discretion to the following matters, where relevant.	
	a)	Integration with and effects on transport and Three Waters infrastructure.
	b)	Consistency with any relevant Integrated Catchment Management Plan or regional discharge consent.
	c)	Effects on significant habitats of indigenous fauna and habitat values of natural water courses.
	d)	Open Space and road reserve design, layout and use.

e)	Consistency with the Ruakura Strategic Infrastructures network for the structure plan as shown on Figures 2-15A and B Ruakura Strategic Infrastructure (Appendix 2); or consistency with the Te Awa Lakes Framework Plan Figure 2-19 (Appendix 2).
f)	Where staged development of any Land Development Area is sought then the following information for the balance area shall be provided: <ul style="list-style-type: none"> i. The indicative location and width of proposed roads and carriageways and their integration with the existing and future transport network; ii. The indicative location of proposed Ruakura Strategic Infrastructure to ensure connectivity across the entire structure plan and adjacent Land Development Plan Areas.
g)	Construction effects.
h)	Effects of new stormwater ponds and wetlands (excluding swales) on private property.
hh)	In the Te Awa Lakes Structure Plan Area, reverse sensitivity effects on the transport network and existing industrial activities.
In determining the application, the Council shall consider the following assessment criteria:	
hh h)	In the Te Awa Lakes Structure Plan Area, whether the Land Development Plan is consistent with the objectives and policies for the Te Awa Lakes Structure Plan Area.
i)	Whether there is appropriate Three Waters infrastructure and capacity, existing and proposed, to appropriately service anticipated development in the Land Development Plan area. For new stormwater ponds and wetlands, the extent to which the following adverse effects of the works on adjacent private property are avoided: <ul style="list-style-type: none"> i. Flooding and adverse effects on ground water levels; and ii. Creating habitat for mosquitoes and other undesirable insects.
j)	Whether the proposal is consistent with, or otherwise complies with, the recommendations, measures and targets of any relevant Integrated Catchment Management Plan.
k)	Whether anticipated development in the Land Development Plan area integrates with, and minimises adverse effects on the safe and efficient functioning of the transport network and transport infrastructure, having regard to the cumulative traffic effects of other approved Land Development Plans. The extent to which the Land Development Plan provides for the sequential extension of the Spine Road for Ruakura.
l)	Whether the Land Development Plan is consistent with Figure 2-18 Cyclist and Pedestrian Network Plan (Appendix 2) for Ruakura and Figure 2-19 Framework Plan for Te Awa Lakes.
m)	The ITA matters for assessment set out in Appendix 1.3.3 G.
n)	Whether the Land Development Plan considers and responds to the recommendations and proposed conditions of the Integrated Transport Assessment and Water Impact Assessment prepared to accompany the application, and for Te Awa Lakes Land Development Plans, the extent to which

		it achieves the Travel Demand Management plan and its outcomes specified in 1.2.2.21 s).
	o)	The potential for cumulative construction noise effects to adversely affect individual residential properties, and the mitigation methods proposed to minimise such effects.
	oo)	In the Te Awa Lakes Structure Plan Area the extent to which noise sensitive activities protect themselves from effects resulting from the operation of industrial activities and the transport network through a combination of acoustic insulation, orientation of habitable areas and outdoor living spaces, and other methods to avoid, remedy or mitigate reverse sensitivity effects.
	p)	Whether the Land Development Plan considers and responds to issues and outcomes arising from consultation with relevant road controlling agencies, the New Zealand Transport Agency and, where relevant, KiwiRail and Fonterra Limited.
	q)	Whether appropriate consideration has been given to electrical hazards and earthworks and ground level changes associated with the installation of underground Infrastructure within 12 metres of a National Grid support structure for Ruakura and consideration of the high pressure gas pipeline for Te Awa Lakes.
	r)	Where land development will cause loss of significant habitats of indigenous fauna (including but not limited to, black mudfish, shortfin eels and longfin eels), require that unavoidable adverse effects on such habitat are remedied or mitigated through: <ul style="list-style-type: none"> i. Replacing significant habitat; or ii. Creating new habitat; or iii. Enhancing areas of alternative habitat supporting similar ecological values and/or significance; and iv. Legal and physical protection.
	s)	Whether land development will adversely affect the flooding, water quality and habitat values of adjoining natural water courses.
	t)	Whether the Landscape Concept and Ecological Enhancement Plan provides for a comprehensive and connected section of Open Space and road reserves, which incorporates, as necessary: <ul style="list-style-type: none"> i. connectivity of open space and streets; ii. passive and active recreation opportunities; iii. Crime Prevention Through Environmental Design principles; iv. pedestrian and cycle paths forming a network with adjacent parts of the Open Space network; v. general amenity planting and amenity for adjoining properties, including use of specimen trees in roads; vi. street furniture; vii. provision for habitats; viii. lighting design that does not deter bat movement; and ix. stormwater management.
	u)	Whether the Land Development Plan will appropriately provide for indigenous

	<ul style="list-style-type: none"> i. fish and lizards; and ii. bats for Te Awa Lakes.
v)	Whether the Land Development Plan includes a greenway that provides for improved habitat and ecological benefits for Ruakura.
w)	Whether the Landscape Concept and Ecological Enhancement Plan provides for a greenway to enhance long term ecological function for Ruakura.
x)	Where the boundaries of a Land Development Plan Area in application for Land Development Consent differ from those shown on Figure 2-16 for Ruakura or Figure 2-21 for Te Awa Lakes, the extent of the Land Development Plan Area shall be developed in an integrated manner. This shall include the provision for and connectivity to infrastructure, and ensure that key infrastructure such as the Spine Road for Ruakura is developed in a manner that provides at least the same levels of efficiency, effectiveness and safety anticipated through a land development consent in accordance with Figure 2-16. Where an application includes part of a Land Development Plan Area in Figure 2-16 (Ruakura) or Figure 2-21 (Te Awa Lakes) it shall be demonstrated that granting consent to that part will not prevent the integrated development of the balance of that Area.
xa)	For Te Awa Lakes the extent to which the recommendations of the alligator weed management plan are to be implemented.
xb)	For Te Awa Lakes the extent to which the Ecological Rehabilitation and Management Plan (ERMP): <ul style="list-style-type: none"> i. Replaces significant habitat or creates new habitat or enhances areas of alternative habitat supporting similar ecological value and/or significance and provides legal and physical protection. ii. Provides comprehensive and connected open spaces that incorporate provision for habitats and stormwater management. iii. Provides for indigenous fauna. iv. Provides for improved habitat and ecological benefit. v. Provides for enhanced long-term ecological function. vi. Provides for appropriate monitoring and review.
Additional Matters for Open Space	
y)	Whether the layout and design of Open Space: <ul style="list-style-type: none"> i. Creates an informal parkland character; ii. Integrates with the landscape design of roads within the Land Development Plan area; iii. Applies Crime Prevention Through Environmental Design principles; iv. Utilises planting to soften the views of industrial development; v. Contains pedestrian and cycle paths forming a network with adjacent parts of the Open Space Network; vi. Provides for the amenity of adjoining and adjacent activities; vii. Integrates linear wetlands and stormwater treatment devices.
z)	Whether provision has been made to ensure public access to and use of the Open Space, except as may need to be limited for safety reasons.

	aa)	The extent to which the different functions of Open Space are clearly identified and provided for in the Land Development Plan application.
Additional Matters for the Medium Density Residential Zone		
	bb)	The extent to which the street network promotes a high degree of connectivity and permeability through the following: <ul style="list-style-type: none"> i. A grid-like street layout. ii. Block sizes that promote permeability for pedestrians/cyclists as well as for vehicles. iii. Connections to the City-wide arterial networks. iv. Paths to the Open Space Network.
	cc)	Street amenity shall be provided by the location of specimen trees and landscaped areas interspersed by kerb-side parking.
	dd)	When assessing the suitability for residential buildings to be within the side yards, regard shall be given to the following: <ul style="list-style-type: none"> i. The extent to which reasonable sunlight and daylight access to adjacent dwellings and outdoor living areas will be affected. ii. The extent to which pedestrian access to the rear of the site will be hindered. iii. The extent to which on-site amenity is maintained.
Additional Matters for Precinct C within the Knowledge Zone - Ruakura		
	ee)	The extent to which the street network is: <ul style="list-style-type: none"> i. Orientated toward the Ruakura Retail Centre. ii. Permeable for pedestrians/cyclists as well as for vehicles. iii. Legible with a simple and readily understood street pattern. iv. Provides a connected path network to the Ruakura Open Space Zone.
	ff)	The extent to which blocks and lots are configured to facilitate walking and accommodate operational areas in rear yards.
Additional Matters for the Logistics Zone (Inland Port) - Ruakura		
	gg)	Whether the planting of the Landscape Buffer Areas will achieve the purpose of screening the Inland Port (Sub Area A (Inland Port)) from Ryburn and Percival Roads.
	hh)	The effects of the planting of the Landscape Buffer Areas on the operation, maintenance, upgrading and development of the National Grid transmission network and the requirements of the Growth Limit Zones Schedule of the Electricity (Hazards from Trees) Regulations 2003.
	ii)	Whether Level of Service D will be achieved at the intersections of Silverdale Road and Knighton Road with Ruakura Road when Stage 1 of the Inland Port (Sub Area A (Inland Port)) is operational.
Construction - Ruakura		
	jj)	Whether appropriate conditions can be placed on the resource consent to manage adverse effects associated with construction of the activities proposed in the Land Development Plan. This will be satisfied by a condition requiring the lodgement of a Construction Management Plan for Council approval, prior to the commencement of the works.

		<p>The Construction Management Plan shall include at a minimum:</p> <ul style="list-style-type: none"> i. Details of the works, their timing and duration. ii. Methods to control dust, debris on roads and silt laden runoff during construction. iii. Anticipated truck movements and routes to and from the site during construction. iv. Means to ensure compliance with the Construction Noise Standards in Rule 25.8.3.2 and Construction Vibration Standard in Rule 25.8.3.3. v. Contact details for the contractor, including a process for complaints and remedying concerns. <p>The Construction Management Plan shall also ensure that:</p> <ul style="list-style-type: none"> vi. Prior to the opening of the Waikato Expressway (Hamilton Section) and the realignment of Ruakura Road to traffic, construction traffic arising from the Land Development Plan area shall be managed to ensure that the capacity of local roads, as determined by normal Hamilton City Council traffic management design criteria, is not exceeded. vii. Once the Waikato Expressway (Hamilton Section) and realigned Ruakura Road are open for traffic, construction traffic arising from the Land Development Plan area shall, to the extent reasonable and practicable, be directed to use the Waikato Expressway (Hamilton Section) to minimise effects on local roads.
N2	Construction Noise and Operation Noise of the Inl and Port (Sub Area A) - Ruakura	
	a)	<p>The extent to which:</p> <ul style="list-style-type: none"> i. The construction and operation of the Inland Port avoids or mitigates adverse noise and vibration effects on adjoining facilities, existing residential dwellings and/or Large Lot Residential zoned areas. ii. Measures to avoid where possible, and otherwise minimise sudden and/or loud noises at night have been incorporated. iii. Lower noise producing equipment and methods have been investigated and incorporated. iv. The location and orientation of refrigerated containers have been selected to minimise noise effects on residential properties. v. The accuracy of the noise model used for predicting noise levels in Stages 2 and 3 of the development of the Inland Port, taking into account recalibration based on monitoring of previous stages.
	b)	The adequacy of the consideration of alternative methods that would meet the night time noise limits set out in Rule 25.8.3.13 and their costs and benefits.
	c)	At individual residential properties where noise levels would exceed the night-times noise limits set out in Rule 25.8.3.13, the extent to which the ambient night-time noise levels at those properties exceed 40 dBL _{Aeq(15)} once the Waikato Expressway is operational.
N3	Ruakura Retail Centre	
	a)	Staged development should be in accordance with an overall master plan for the Ruakura Retail Centre which shall show the location of the Ruakura Retail Centre Mainstreet, building footprints, circulation network, public open space and provision for parking.
	b)	A Ruakura Retail Centre Mainstreet shall be provided and should be orientated

		towards and integrate with the location of the proposed transport interchange.
	c)	Buildings should directly align and address the street network and provide a constant and intact edge to streets and public places.
	d)	Buildings should be located and designed to avoid extensive or inactive edges with entrances designed to maximise pedestrian flow and to support active street frontages.
	e)	Building frontages to the Ruakura Retail Centre Mainstreet should incorporate a high proportion of glazing and provide veranda canopies over footpaths and a high level of ground floor architectural detail.
	f)	Building design should create a varied fine grained pattern of development through the modulation of height and roof form, façade depth and relief and variety in materials and colours.
	g)	Site Layout should provide options for pedestrian, cycling and vehicular circulation and permeability within and to adjoining areas.
	h)	Footpaths should be legible and be of a sufficient width with quality paving and detailing, including footpaths to and from the centre and Open Space Areas.
	i)	Where public open space is provided, it should be centrally located adjacent to main pedestrian flows and shall be highly visible.
	j)	Public outdoor spaces should be sheltered and sunny with provision for summer shade and shall be anchored by active building edges.
	k)	Carparks should be landscaped to define the street boundary and adjacent spaces.
	l)	Carparking should avoid interrupting active frontages and pedestrian circulation along the Ruakura Retail Centre Mainstreet.
	m)	Loading and service areas should not interrupt active edges and should be separated from public circulation where possible.
N4	Concept Plan for Precincts A, B and D in the Knowledge Zone - Ruakura	
	a)	General
		The extent to which the proposal is consistent with the approved Concept Plan for the Precinct within the Knowledge Zone.
	b)	Concept Plan Development
	i.	The extent to which the preparation of a Concept Plan or an update to an existing Concept Plan has given regard to the following.
	a)	The extent to which the precinct integrates with surrounding land uses and the transport network.
	b)	Whether the development has been designed to minimise any adverse effects on adjoining activities, particularly residential activities.
	c)	The degree to which any large façades (including side walls) that are visible from public places have been modulated, articulated, detailed or visually treated in a way that reduces the apparent bulk of the building or provides visual interest.
	d)	The extent to which the proximity of facilities intended to accommodate events are sited close to residential areas.
	e)	The extent to which the provision for vehicular and pedestrian access and circulation facilitates ready dispersal of vehicles and patrons from large events.
	f)	The extent to which provision for vehicular and pedestrian access and circulation prioritises pedestrian safety.

		g) The extent to which appropriate, convenient provisions enable public transport to service the site, recognising the need for such services to directly access the Central City area.
	ii.	The extent to which the following have been applied as part of a new Concept Plan, an update to an existing Concept Plan or in the absence of a Concept Plan within the Interface Areas of Precincts A, B and D.
	a) Built Form and Layout	
	i.	The extent to which the external appearance, scale and design of buildings: <ul style="list-style-type: none"> • Contributes to compatibility between buildings and its integration with other development on the site, adjacent sites and surrounding public spaces; • Contributes to active frontage along public streets and open space, particularly for corner sites; • Minimises, as practicable, effects on adjacent public spaces (including footpaths) in terms of shading and daylight.
	ii.	The extent to which building design and development: <ul style="list-style-type: none"> • Makes a positive contribution to the local character of the site and surrounding areas; • Ensure large facades are well designed to provide visual interest and reduce the apparent bulk of buildings within the Interface Area; • The extent to which crime prevention through environmental design principles have been incorporated.
	b) Landscaping	
	i.	Incorporation of landscaping within the site layout to reduce the bulk of new development and mitigate adverse visual effects of development within the Interface Area, particularly as they interact with public spaces.
	ii.	Incorporates landscaping to maintain and enhance the character and amenity of the site and surrounding areas.
N5	Ruakura Open Space Zone	
	a)	For new stormwater ponds and wetlands, the extent to which adverse effects of the works on adjacent private property are avoided in relation to:
	i.	Flooding and adverse effects on groundwater levels; and
	ii.	Creating habitat for mosquitoes and other undesirable insects
N6	Development within a Greenfield Area – Ruakura	
	a)	The extent to which the proposal is consistent with an approved Land Development Plan or could prejudice or foreclose options for future urban development and in particular with the proposals shown on Figure 2-14, Ruakura Structure Plan – Land use (Appendix 2).
	National Grid Corridors – Ruakura	
N7	For crossing points for Mobile Plant that are a Restricted Discretionary Activity in Table 25.7.4, the matters to which the Council shall restrict its discretion are limited to the actual and potential effects of crossing points on the scale and efficient operation and maintenance of the National Grid.	
N8	In determining any application for resource consent for crossing points, the Council shall have regard to the following matters:	

	a)	Suitable mechanisms are in place to ensure that mobile plant and machinery moving in the National Grid Yard can not infringe safe clearance distances specified in NZECP:34. This may include physical, operational or electronic measures and will be deemed satisfied by overhead gate structures (e.g. hurdles) being erected no closer than 4.5 metres from the lowest sag of the line at maximum operating temperature.
	b)	Crossings are approximately perpendicular to the National Grid Yard.
	c)	Crossings and any associated traffic management structures are located no closer than 12 metres from the outer visible edge of a National Grid support structure.
	d)	Any overhead gate structure (e.g. hurdle) is constructed to a suitable engineering standard to withstand vehicle (including mobile plant transporting containers) impact travelling at normal operating speed.
	e)	Appropriate management and operational methods to ensure safe procedures are specified in the resource consent conditions and followed when crossing beneath the lines.
N9		For the unloading and loading of containers, stacking containers, container stacks, operation of mobile plant associated with these activities and Light Towers, noise walls and fences greater than 2.5 metres high, the matters to which the Council shall restrict its discretion are limited to the actual and potential effects of these structures, buildings and activities on the safe and efficient operation and maintenance of the National Grid. In determining any applications for resource consent for these structures, buildings and activities, the Council shall have regard to the following matters.
	a)	Any operational procedures and physical measures to ensure compliance with NZECP:34, including layout and allowable height limits for container stacking.
	b)	Light towers shall ensure sufficient clearances in accordance with NZECP:34 are provided including any setback requirements for mobile plant required for maintenance and lamp replacement.
	c)	Suitable mechanisms are in place to ensure that mobile plant and machinery moving in the National Grid Corridor can not infringe safe clearance distances specified in NZECP:34. This may include physical, operational or electronic measures.
N10		For earthworks that are a Restricted Discretionary Activity the matters to which the Council shall restrict its discretion are limited to:
	a)	The effects of the earthworks on the operation, maintenance, upgrading, and development of the National Grid transmission network.
N11		For Subdivision that is a Restricted Discretionary Activity the matters to which the Council shall restrict its discretion are limited to:
	a)	The extent to which the subdivision design, including the location of roads and reserves, landscaping and building platforms, allows for activities to be set back from National Grid transmission lines to ensure adverse effects on, and from, the National Grid and on public safety are appropriately avoided, remedied or mitigated.

	b)	The extent to which the subdivision design/layout and consequential development will minimise the potential reverse sensitivity on, and amenity and nuisance effects of, the National Grid.
	c)	The provision for on-going inspection, operation, maintenance and development of the National Grid, including continued reasonable access.
	d)	The extent to which the design and development will minimise the risk of injury and/or property damage from such lines.
	e)	Compliance with the New Zealand Electrical Code of Practice for Electrical Safe Distances (NZECP: 34).
	f)	Outcomes of any consultation with Transpower New Zealand Limited.
Te Awa Lakes: Lake Management		
N12	In determining the application for a resource consent for a restricted discretionary activity, Council shall reserve its discretion to the following matters, where relevant.	
	a)	The extent to which implementation of the management plan required under Appendix 1.2.2.21 n) will maintain a high level of water quality for recreational use in the main linear lake, including the extent to which a target of swimmable quality will be achieved.
	b)	The extent to which any delay in establishing the main linear lake will affect residents' and visitors' ability to undertake recreational activities within or on the lake, considering possible changing seasonal demands for different types of activities.
Te Awa Lakes Earthworks and Land Remediation		
N13	In determining the application for Land Development Activities as a Restricted Discretionary Activity, Council shall reserve its discretion to the following matters, together with reference to Objectives 22.2.1 and 25.2.2.1, where relevant:	
	a)	The extent to which appropriate building platforms can be provided free from any identified hazards.
	b)	The extent to which the applicant has demonstrated through the use of an engineering design report: <ul style="list-style-type: none"> i. That the risk of ground failure can be minimised to avoid effects on the safety of occupiers and neighbours. ii. That any structure will perform safely under hazard conditions for the life of the structure. iii. That any work to be carried out maintains the stability of the site, including the riverbank and gully and does not increase the risk of ground instability on the subject site or adjacent sites. iv. That the potential for preferential flow paths to be created between the linear lake and the Waikato River is minimised by ensuring a maximum hydraulic gradient of 2% between the linear lake and the River is maintained at all times.
	c)	The extent to which the land development activities: <ul style="list-style-type: none"> i. Provide any sediment control measure necessary to control the discharge of sediment. ii. Remain safe and stable for the duration of the intended land use. iii. Provide safe and accessible building sites and infrastructure.

	<ul style="list-style-type: none"> iv. Provide for the adequate control of stormwater, cater for natural groundwater flows, and avoid adverse effects from changes to natural water flows and established drainage paths. v. Avoid exacerbating the effects of natural hazards and ecological effects arising from additional sediment release.
Te Awa Lakes Earthworks and Land Remediation: Land Development Plan Areas Q and R, and Area X in the Te Awa Lakes Business 6 Zone	
N14	<p>The purpose of these assessment criteria is to ensure that temporary and long-term residual risks of piping erosion or other ground failure resulting from future activities on Areas Q and R, and Area X in the Business 6 zone, are mitigated and minimised to the fullest extent practicable.</p> <p>In determining the application for Land Development Activities as a Discretionary Activity in Land Development Plan Areas Q and R, and resource consents for a Discretionary Activity in Area X in the Business 6 zone, Council shall, in addition to N13, take into account:</p>
	a) The extent to which the landform design directs surface water towards the lake rather than the river.
	b) The results of appropriate assessment and design to demonstrate the required landform width in Areas Q and R and Area X minimises to the fullest extent practicable the long-term residual piping erosion and land stability risks resulting from future activities on Areas Q and R and Area X.
	c) Design of the final ground surface level to ensure services are able to be located above the groundwater table.
	d) The extent to which measures such as low permeability lining are proposed to be placed over the base of services trenches to prevent infiltration of water to the ground via permeable backfill.
	e) The extent to which combined services trenches are proposed to minimise the risk of unintended water flow and flow-induced erosion from multiple service trenches.
	f) The extent to which the landscape concept plan required by Rule 1.2.2.21 (j) includes suitable tree sizes and vegetation species on land adjoining Areas Q and R and Area X.
	g) The extent to which any roads and accessways should remain in private ownership and management to ensure an appropriate management body manages service installations, renewals and maintenance in a manner to minimise any risk of unintended water flows and flow-induced erosion, and the proposed details of any private ownership and management entity
	h) The extent to which rainwater re-use tanks are avoided unless overflows are directed by pipe or over impermeable surfaces to the lake, and the extent to which this requirement is to be implemented on an ongoing basis through consent notices or other legal mechanism.
	i) The extent to which the Landscape Concept Plan required under Rule 1.2.2.21(j) is extended to apply to proposed lots to ensure suitable tree sizes and vegetation species are established, and the extent to which the Plan should be implemented on an ongoing basis through consent notices or other legal mechanism.

	j)	Whether specific geotechnical designs of all structures are provided.
	k)	The extent to which any of items a) to j) should take precedence over any other engineering provisions in the Plan and the requirements of the Regional Infrastructure Technical Standards (RITS).
	l)	Any other measures proposed to ensure that temporary and long-term residual natural hazard risks resulting from future activities on Areas Q and R and Area X fulfil the purpose of these assessment criteria.
<u>Q</u>		<u>Rotokauri North</u>
<u>O1</u>	a)	<u>The landscape buffer and associated planting will provide visual amenity and screening between State Highway 39 (SH39) and Rotokauri North and contribute to indigenous biodiversity.</u>
	b)	<u>The extent to which the proposed private legal entity that will own the landscape buffer will ensure the buffer's on-going protection and maintenance.</u>
<u>O2</u>		<u>For the creation of a private rear lane, the extent to which:</u>
	a)	<u>An appropriate legal mechanism for ownership and ongoing maintenance of the lane will be established, and including any requirement for indemnity for collection of solid waste and recycling (where these are proposed to enter the rear lane</u>
	b)	<u>The lane is designed to accommodate the passage of large rigid trucks such as fire, furniture removal, refuse and recycling-collection trucks (where these are proposed to enter the rear lane).</u>
	c)	<u>The rear lane's design including traffic calming measures to promote slow vehicle speeds and provide a safe shared space</u>
<u>O3</u>		<u>All restricted discretionary, discretionary and non-complying activities:</u>
	a)	<u>The extent to which the proposal gives effect to the objectives and policies of the Rotokauri North Structure Plan within Chapters 3, 4 and 23.</u>
	b)	<u>The extent to which the proposal avoids, remedies or mitigates adverse effects on, or where possible enhances, any significant habitats of indigenous fauna.</u>
	c)	<u>Provides for, is consistent with, or could prejudice or foreclose options for, future development of the elements identified on the Structure Plan</u>
	d)	<u>Restores and enhances aquatic and terrestrial ecological values associated with springs, streams, waterways, wetlands and their margins in Rotokauri North.</u>
	e)	<u>Restores and enhances the natural, cultural, heritage and amenity values of Rotokauri North's open spaces.</u>
	f)	<u>Recognises and provides for mana whenua values and relationships with Rotokauri North and their aspirations for the area, including interpretation of the landscape's significance, protection and preservation of sites of significance</u>
	g)	<u>Reflects the area's character and heritage.</u>
	h)	<u>Has been planned with the active involvement of mana whenua.</u>
	i)	<u>The design and construction of walking and cycling infrastructure, including in the Green Spine, and the extent to which this infrastructure provides</u>

		<u>alternative means of travel to the private car, and for recreational use, and connects to the transport network.</u>
	j)	<u>The extent that subdivision provides an interconnected transport network that achieves pedestrian and cycle connectivity east to west and vice versa (particularly in the northern half of the structure plan area) to avoid these movements on SH39.</u>
<u>O4</u>		<u>For any subdivision of a duplex which meets Rule 4.7.12(a), the Council will restrict its discretion to the following matters:</u>
	a)	<u>Whether the sites can be appropriately serviced for infrastructure and access.</u>
<u>O5</u>		<u>For any duplex complying with Rule 4.7.12.a i) and ii) but not the Rotokauri North Acceptable Solutions Code in Rule 4.14 the Council will restrict its discretion to the following matter:</u>
	a)	<u>Whether the alternatives provided will result in the same or a better urban design outcome than that envisaged by the Rotokauri North Acceptable Solutions Code.</u>
<u>O6</u>		<u>The creation or upgrading of all or part of a Collector or Minor Arterial transport corridor:</u>
	a)	<u>The extent to which the design has allowed for the provision of public transport to be included in the transport corridor (including facilities for pedestrians to cross roads to access public transport stops, carriageway width, turning facilities, accessible bus stops) as identified indicatively on Figure 2-9C</u>
	b)	<u>The outcome of any consultation with the Waikato Regional Council regarding public transport.</u>
<u>O7</u>		<u>Where service areas are for apartments consideration will be given to:</u>
	a)	<u>Whether sufficient space can be provided for service activities and rubbish collection such that each unit has either individual space or access to appropriately sized communal spaces.</u>
	b)	<u>Whether sufficient screening can be achieved for communal areas of rubbish storage particularly where these can be viewed from public spaces.</u>
<u>O8</u>	a)	<u>Neighbourhood parks should be dispersed within Rotokauri North so that no residential unit is more than 500 metres walking distance from a neighbourhood park, or any other park and/or reserve which provides for the same or a similar level of passive and active recreation opportunity.</u>
	b)	<u>Neighbourhood parks should generally be: approximately 5000 m2 in area; have at least 50% of the total neighbourhood park boundary to a transport corridor frontage (unless accommodated within the Green Spine); on land that is generally flat and able to accommodate a 30m2 area.</u>
<u>O9</u>		<u>Where stormwater infrastructure is provided “commensurate with that required to service that stage of development”, the stormwater infrastructure being provided:</u> <ul style="list-style-type: none"> • <u>Is consistent with the sub-catchment ICMP required by Rule 3.6.A.4.2e)i);</u> • <u>Includes an adequate area to establish the Rotokauri North Structure Plan’s ‘green spine’ concept;</u>

		<ul style="list-style-type: none">• <u>Meets the storage volume, conveyance and treatment requirements of the sub-catchment ICMP required by Rule 3.6.A.4.2e)i); and</u>• <u>Addresses any interim and permanent stormwater related effects on flow, water levels, water quality and ecology on the upstream and downstream areas.</u>
--	--	---

1.4 Design Guides

1.4.1 Subdivision Design Guide

1.4.1.1 Purpose

This section provides design guidance for any subdivision undertaken within the City. It contains general guidance for subdivision in any zone, as well as specific guidance for subdivision in the General Residential Zone.

The assessment criteria for subdivision, outlined in Section 1.3.3, require applications to be assessed against the Subdivision Design Guide. Information Requirement 1.2.2.2 - Subdivision Concept Plan - also requires consideration against the Subdivision Design Guide outlined here.

1.4.1.2 How to Use the Design Guide

Applications for subdivision shall include an assessment against the Design Guidance included in this Appendix as they are relevant to the nature and scale of the subdivision proposed.

Section 1.4.1.3 General Design Guidance and section 1.4.1.4 General Residential Zone apply to all subdivision, except:

- residential subdivision creating four or less residential lots; or
- residential subdivisions that are based on the layout and pattern of occupation associated with a previously approved or permitted residential development.

Where necessary, in regard to any relevant criterion that is not met, the applicant shall explain:

- i. Whether site constraints inhibit the ability to address the criterion.
- ii. How the intention of the criterion is met by the proposal.
- iii. Whether the proposal represents a better design solution than that sought by the criterion.

Note

1. Acceptable means of compliance for the provision, design and construction of infrastructure is contained within the Hamilton City Infrastructure Technical Specifications.

1.4.1.3 General Design Guidance

Design Element 1: Public Interfaces

- a) Public open spaces should be bounded by public transport corridors where possible (refer Figure 1.4.1a).
- b) Where a transport corridor boundary is not practicable, private-way boundaries with public open spaces should be provided to ensure that buildings front on to public open spaces (refer Figure 1.4.1b).
- c) Private ways where abutting public open spaces should ensure sightlines to the public open space via permeable fencing (see rule 15.4.6).

Figure 1.4.1a: Poorly located public open space, lacking boundaries with public transport corridors



Figure 1.4.1b: Subdivision layout

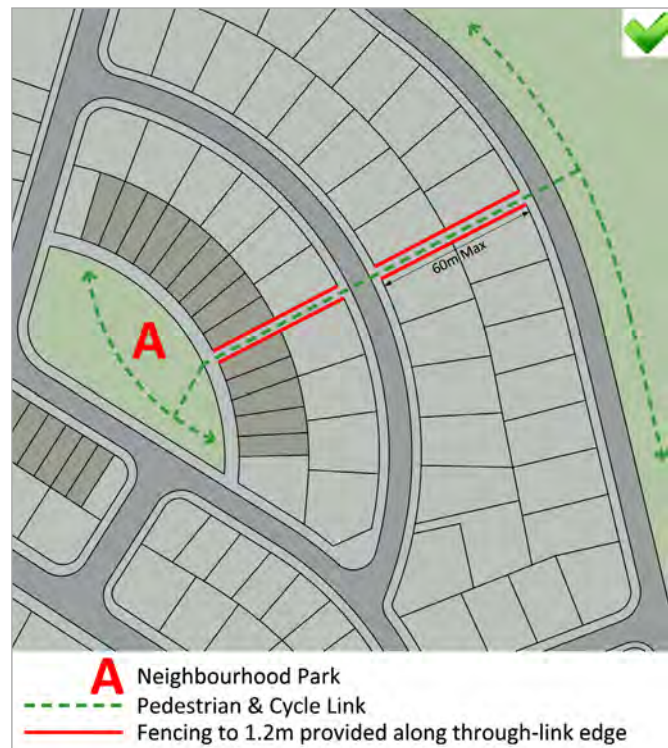

Showing:

- Well located public open space (A), with boundaries to public transport corridor and private ways.
- Clear and straight pedestrian and cycle links with maximum lengths and fence height limits providing improved connectivity and following CPTED principles.

Design Element 2: Pedestrian Accessways

Pedestrian accessways should:

- a) Be designed in a manner consistent with CPTED principles – facilitating passive surveillance and adequate lighting where appropriate (refer Figures 1.4.1e and 1.4.1f).

Figure 1.4.1e: Cross section showing a well designed interface between allotments and a pedestrian accessway. Low, visually permeable fences and walls, low cut planting and adequate lighting creates a 'safer' public space

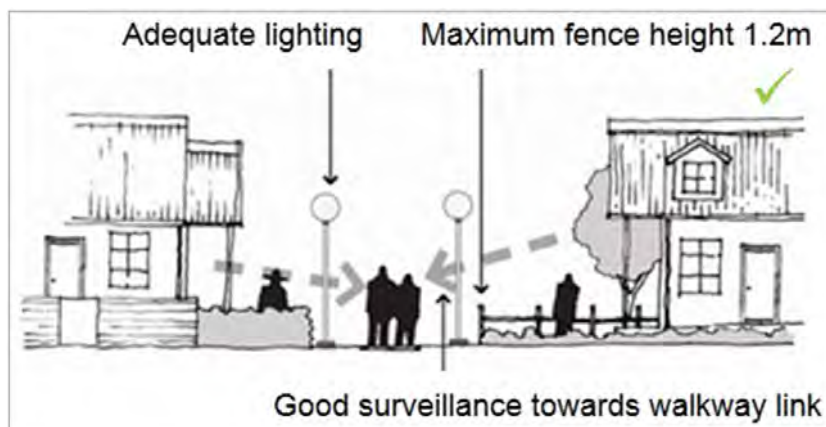

- b) Include clear and coherent direction signs.
- c) Be of an easy gradient and where possible avoid the need for steps.

Figure 1.4.1f: Poorly designed interface with pedestrian accessway. High, visually impermeable fences, poor lighting and landscaping prevents passive surveillance



Design Element 3: Public Open Spaces

- a) All public open spaces should be of an appropriate size and dimensions to allow for their anticipated primary function. Land to be vested as public open space will be accepted by the Council only if it is suitable for the intended functions.

- b) Subdivision layout should provide, where appropriate, opportunities for connections that support the integration of pedestrian and cycling networks within and between the transport and open space networks (refer Figure 1.4.1g).
- c) Public open spaces should be designed in a manner consistent with CPTED principles.
- d) All public open spaces should:
 - i. Incorporate natural features that contribute to the functioning of ecological corridors, transport corridors and stormwater functions, where relevant.
 - ii. Look to incorporate existing trees and features of interest (natural and cultural).
 - iii. Provide recreational amenity.
 - iv. Contribute to the development of a coherent open space network.
 - v. Be easily accessible where appropriate for all aspects of the community.
 - vi. Be provided as identified on any relevant Structure Plan.
- e) Walking and cycle paths should be provided where appropriate within the public open space network and should be well connected:
 - i. Through the public open space network.
 - ii. With adjacent streets.
 - iii. With other open spaces, community facilities and any other likely destinations.
- f) The provision of public open space under high-voltage transmission lines will be considered on a case-by-case basis having regard to the appropriate use of the land.
- g) Neighbourhood parks should be reasonably flat and be designed and located to provide a focal point for a neighbourhood (refer Figure 1.4.1h).
- h) Where required, car parking should be accessible, appropriately landscaped and designed so that traffic movement can occur in a safe and efficient manner.

Figure 1.4.1g: Public open spaces designed and located to integrate pedestrian and cycling networks with the open space network

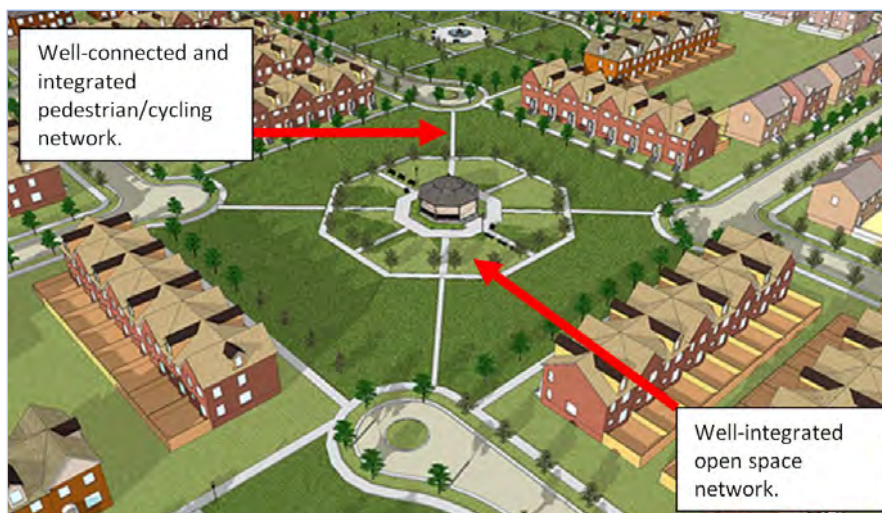

Design Element 4: Transport Network Layout

- a) The proposed transport network layout should:
- i. Create sufficient separation distances and space to provide for safe vehicle access to and from the transport network.
 - ii. Where possible avoid the need for direct vehicle access from allotments on to the strategic or arterial transport network.
 - iii. Minimise local transport corridor connections to arterial or strategic transport corridors.
 - iv. Protect, provide for and be integrated with any planned transport corridors identified in Structure Plans or by designations.

Figure 1.4.1h: Public open spaces designed and located to be a key focal point of the neighbourhood, particularly adjoining uses



- v. Create an accessible, walkable neighbourhood by:
- Providing a highly connected network of transport corridors that enables relatively direct trips in and between neighbourhoods and to local activity points (such as shops, parks, schools and passenger transport stops).
 - Avoiding transport infrastructure designs that disadvantage mobility impaired, pedestrians and cyclists by hindering their ability to move safely and easily.
- vi. Provide links for pedestrians and cyclists and use of passenger transport for daily activities that create an attractive, friendly, efficient, connected, safe and accessible environment.
- vii. Enhance personal safety and perceptions of safety and minimise potential for crime, vandalism and fear.
- viii. Avoid large blocks as these increase the trip lengths between points reducing connectivity, accessibility and the attractiveness of walking or cycling.
- ix. Unless physically constrained avoid culs-de-sac and other layouts that reduce transport network connectivity.

- x. Provide for strong connections to existing, committed and proposed development in adjacent areas, to help with connection and integration.
- b) In accordance with the transport corridor hierarchy, the layout should provide a logical and legible network of connected transport corridors, these corridors should:
 - i. Contribute to a transport network that is accessible for the whole community by maximising connections and opportunities for route and mode choice.
 - ii. Provide local or collector transport corridors for safe property access.
- c) The hierarchy of transport corridors should be reinforced by incorporating design elements appropriate to the transport function and surrounding land use (guidance is available in Appendices 15-4 and 15-6). This may include using landscaping, street materials, and space allocation (e.g. carriageway widths) to signal changes in hierarchy that directs through-traffic to and along higher-order transport corridors and encourages lower speeds in residential or pedestrian-oriented environments.
- d) When considering layouts that connect to existing areas the effects of that connection, such as increased traffic volumes, should be compatible with the form and function of the existing transport network and the surrounding land use.

Design Element 5: Landscaping and Vegetation

- a) Subdivision layout should seek to provide opportunities for retaining existing mature trees.
- b) Streetscape should reflect the functions and characteristics of the road type in the network with larger, uniform and more formally organised trees on major transport corridors and smaller, less-regimented variation along local streets.

Note

1. Guidance on acceptable approaches to the selection and location of street tree planting is contained within the Hamilton City Infrastructure Technical Specifications.

1.4.1.4 General Residential Zone

This section provides design guidance for any General Residential Zone subdivision undertaken within the City which propose to create more than four vacant fee-simple lots.

Design Element 1: Block and Allotment Layout and Orientation

- a) Where possible blocks should be no more than two allotments deep (refer Figures 1.4.1i and 1.4.1j).

Figure 1.4.1i: Subdivision layouts creating deep blocks with large numbers of rear sites are to be discouraged

Figure 1.4.1j: Subdivision layout creating blocks no more than two allotments deep and maximising the creation of front sites is to be encouraged

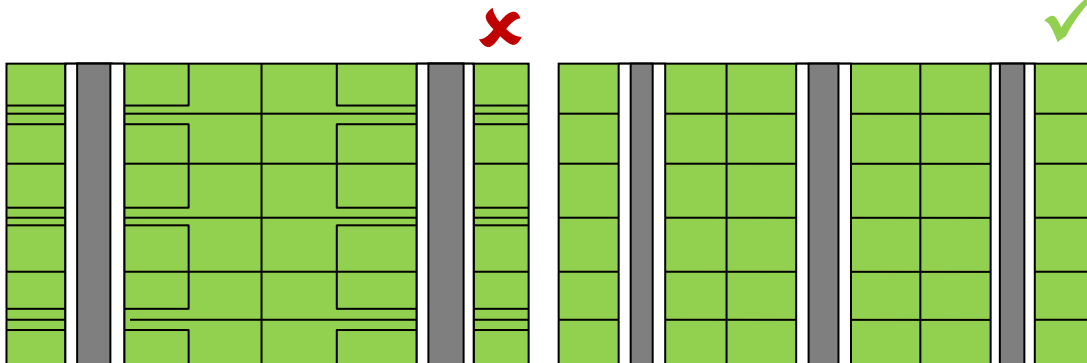

- b) Allotments should be orientated so that dwellings can be located in a manner where their front door and main living area face the adjacent transport corridor – rear sites should generally be avoided (refer Figure 1.4.1k).

Figure 1.4.1k: Allotments oriented to enable dwelling designs that can front the transport corridor



- c) Block length should be limited to ensure high levels of accessibility and connectivity.
- d) Blocks and allotments should be designed to enable good sunlight and daylight into future dwellings. This can be achieved by:
- i. Aligning roads north/south and allotments east/west where possible.
 - ii. Providing south-facing allotments with north-facing backyards for outdoor living.
 - iii. Ensuring sunlight access to transport corridors, including the selection of trees to allow sunlight to penetrate through winter.

Figure 1.4.1l: Blocks and allotments have been located and designed to ensure dwellings and allotments receive a good level of sunlight

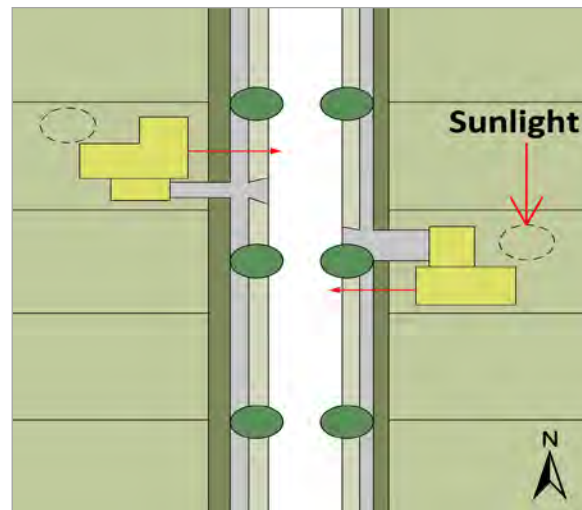

- e) Through allotments should be avoided (refer Figure 1.4.1m).

Figure 1.4.1m: Blocks and allotments should be located and designed to avoid the creation of rear and through allotments

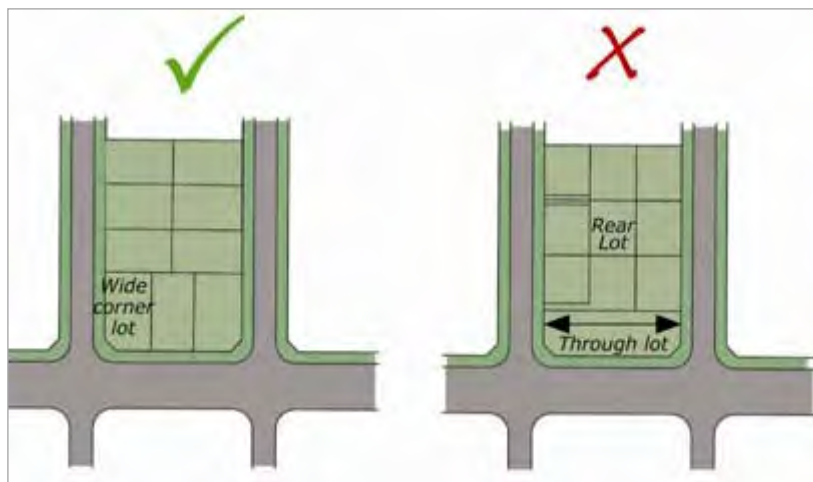

- f) Culs-de-sac should be avoided where possible. Where they are proposed as part of a subdivision, the applicant shall provide:
- i. Justification and reasons why a more integrated movement network cannot be provided.
 - ii. How the proposal manages to achieve appropriate connectivity and accessibility.
- g) Where they cannot be avoided, culs-de-sac should be straight and short (unless physically constrained for example by topography, infrastructure or geotechnical factors) (refer Figure 1.4.1n).

Figure 1.4.1n: Where provided, culs-de-sac should be straight and short

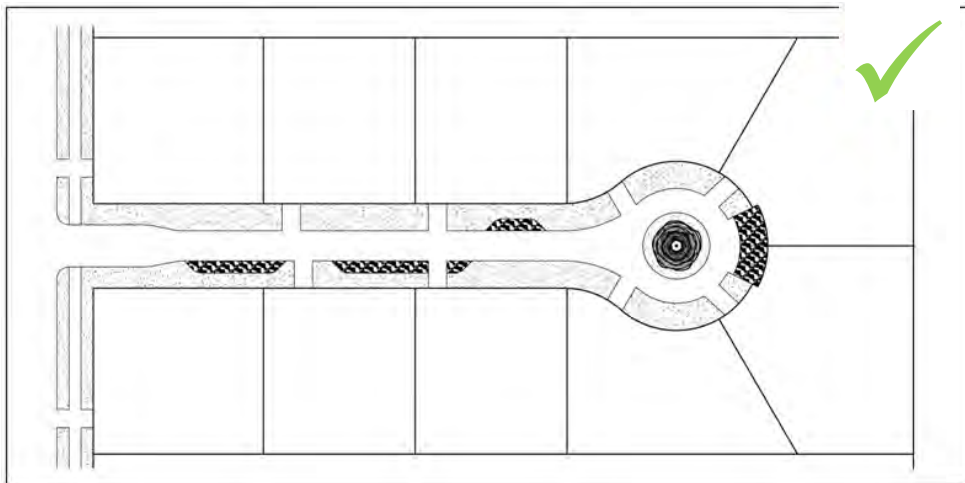

- h) Where culs-de-sac cannot be avoided, they should provide, where appropriate, pedestrian and cycle links to other streets and/or open spaces at their heads to create connectivity and accessibility (refer Figure 1.4.1o)

Figure 1.4.1o: Where vehicle connections cannot be made culs-de-sac should include, where appropriate, pedestrian and cycle links



- i) More than one private-way accessing on to a cul-de-sac should be discouraged where possible.

Where this is proposed, the applicant shall provide justification and reasons showing how the proposal will achieve appropriate connectivity (including safe pedestrian access), how CPTED principles, visitor parking, emergency access and refuse collection are addressed.

1.4.2 Residential Design Guide (Residential and Special Character Zones)

1.4.2.1 Purpose

This section provides design guidance for developments undertaken within the General Residential Zone, Residential Intensification Zone, Large Lot Residential Zone and Special Character Zone. The guidelines apply to:

- a) Apartment buildings
- b) Papakainga
- c) Third and subsequent single dwellings per site
- d) Duplexes
- e) Integrated Residential Developments.

As noted within the section 1.3.3 B Design and Layout, if an activity is a Restricted Discretionary Activity solely to Design and Layout matters and there is a relevant design guide; then the activity should seek to address the outcomes sought in the design guide as a priority over any other criteria in section 1.3.3 B.

1.4.2.2 How to use the Design Guidelines

Applications for development within the Zones as described in 1.4.2.1 should provide an assessment against the guidelines outlined within this Appendix.

As the guidelines are generic, they may not be appropriate in every instance and a degree of flexibility is reasonable and to be expected. In such cases, the creation of an equivalent or better outcome should be demonstrated.

1.4.2.3 Site Size and Dimensions

- a) To ensure good overall design outcomes, the site should be of an appropriate size to accommodate the proposed number of residential units and ancillary spaces, such as car parks and outdoor living areas.
- b) Where possible, the site should have an adequate length of transport corridor frontage to allow residential units to be oriented parallel to the transport corridor (refer Figure 1.4.2a).

Figure 1.4.2a: Preferred unit orientation

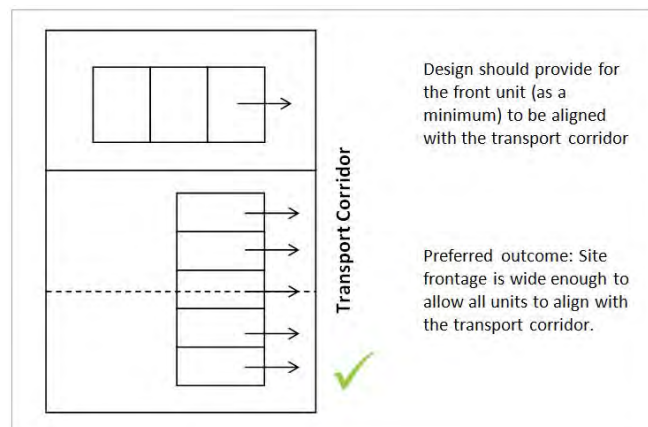

1.4.2.4 Interface between Public and Private Land

- a) Where appropriate, the site layout and building design should promote passive surveillance of adjoining or adjacent public spaces (including transport corridors).
- b) To achieve this, the following aspects need to be considered:
 - Where possible, ensure units have a public front and a more private side or rear.
 - Promote a clear definition between public, semi-private and private spaces through the use of design features which may include low boundary walls and landscaping as appropriate.
 - Avoid bland, featureless elevations, high blank walls and non-permeable fencing.
 - Where possible, orientate habitable rooms, balconies and entrances towards the public space (including transport corridors - refer Figure 1.4.2b, c and d).

Figures 1.4.2b, c and d: Examples showing public/private interfaces that have been well-designed

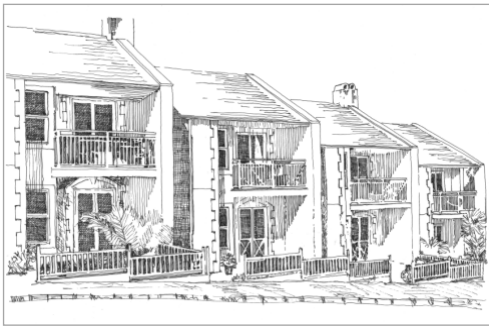

Apartment



Detached dwelling



Duplex

1.4.2.5 Building Orientation and Siting

- a) Buildings should be oriented and located to allow adequate daylight and sunlight to reach principal living rooms and outdoor spaces.
- b) Buildings should be positioned to minimise overshadowing of adjoining buildings or private outdoor spaces.
- c) Buildings should be oriented, sited and designed to accommodate outdoor living areas, service areas and storage areas as well as permeable surfaces.

1.4.2.6 Access, Garages and Parking

- a) Where possible, garages and car parking should not dominate the frontage and should be located to the side or rear of the building to reduce visual impact (refer Figure 1.4.2e).
- b) When locating garages and outdoor parking spaces, consideration should be given to safety for users.
- c) Where possible, driveways should not be located side by side. Preferably use shared driveways to serve more than one residential unit.
- d) The design of the vehicle entry and exit to the site should ensure safety for the residents and pedestrians and the safe and efficient operation of the transport network.
- e) The design and landscaping of car parks should contribute to the amenity of the development and the safety of users.

Figure 1.4.2e: Garage doors forward of the front face of buildings should be discouraged



1.4.2.7 External Appearance

- a) When viewed from any transport corridor or public open space, buildings should be designed to create visual interest through appropriate modulation, articulation, and architectural expression (refer Figure 1.4.2f).

Figure 1.4.2f: Building design that creates visual interest by incorporating a range of features



- b) Features such as balconies, canopies, porches, bay windows, dormers and pediments can also be used to break up continuous building mass and large roof forms.
- c) Height should not exceed the relevant District Plan standard unless the particular design will:
 - i. Contribute to identity and local character.
 - ii. Add interest.
 - iii. Where appropriate, create local landmarks.
- d) Where similar buildings are grouped or joined together, visual interest should be promoted through high quality architectural design, including the use of varying design features, e.g. roof form, canopies, porches, balconies, windows, colour and materials.

1.4.2.8 Private Outdoor Living Areas

- a) Private or communal outdoor living areas should be located either to the north, east or west of the residential unit, readily accessible from a living area within the residential unit (refer Figure 1.4.2g). The private outdoor living area may be at ground level or an upper-storey balcony.

Figure 1.4.2g: Example of a functional, usable and private outdoor living area

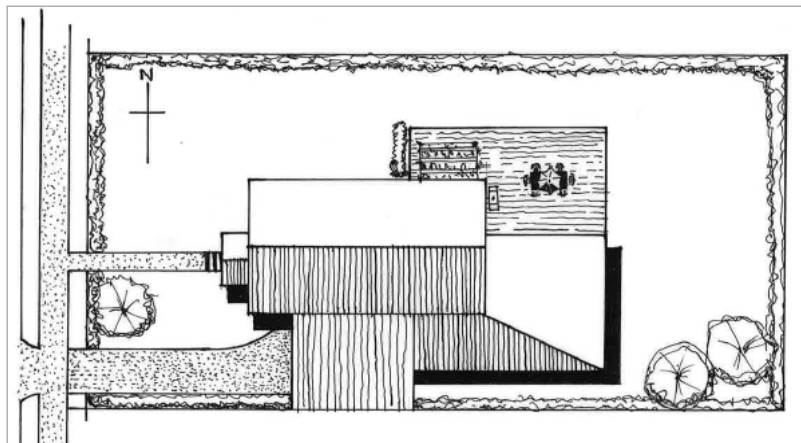

- b) Outdoor living areas should be sited and designed to ensure safe use.

- c) Outdoor living areas should be of appropriate size and dimensions to suit both occupancy and residential unit type. Regard should be given to available shared outdoor space (for multi-unit development) and the proximity of the site to a public open space.
- d) Outdoor living areas should be located and designed to achieve an adequate level of visual privacy, protected from being overlooked from windows and private outdoor living areas of adjacent residential units. Responses could include:
 - i. The shape and position of buildings, spaces and windows.
 - ii. Varying levels.
 - iii. Separation distance.
 - iv. Screening such as hedges.
 - v. Offset and high sill windows.
 - vi. Opaque glass.

1.4.2.9 Landscaping and Vegetation

- a) Where possible, existing mature trees should be retained where they contribute to site amenity.
- b) Landscaping and vegetation should complement the layout of the site and the buildings.

1.4.2.10 Acoustic Amenity

- a) Attached dwellings should be designed to minimise sound transmission between residential units.
- b) Noise-producing activities such as driveways and/or car parks should be separated from bedroom windows of adjacent residential units.
- c) Residential units should be designed with appropriate acoustic treatment to maintain residential amenity.

1.4.2.11 Service Areas

- a) Outdoor service areas should be provided for solid waste and recycling storage without creating adverse visual, noise or odour effects for residents or neighbours.
- b) The waste and recycling storage in outdoor service areas should be easily accessible for residents and collection agencies.

1.4.2.12 Water Efficiency

- a) Water-sensitive techniques should be used where possible.
- b) Sites should ensure a sufficient area of permeable surface to manage the volume of stormwater entering the reticulated system (e.g. through stormwater collection and detention); or be able to provide alternative stormwater solutions.
- c) Landscaping should be used to minimise and control the impacts of stormwater run-off. This could be through use of vegetation filtration techniques (e.g. swales

and rain gardens, refer Figures 1.4.2h and 1.4.2i) and choosing appropriate plant species.

- d) The reuse of water including grey water should be considered and adopted where appropriate. (Also see Waikato Regional Council requirements.)

Figures 1.4.2h and i: Examples of swales to manage stormwater (from Hobsonville and Long Bay, Auckland)



1.4.2.13 Integrated Residential Developments

In addition to the above design guidelines, the following should be considered when preparing and assessing a resource consent application for an integrated residential development:

- f) Developments should be designed to minimise adverse impacts on neighbouring sites, the streetscape and the character of the area.
- g) This includes, where applicable, consideration of building height and the impact on views and vistas to and from the site and the natural landform.
- h) The built form should be residential in nature and scale and where possible avoid excessive repetition of architectural styles.
- i) As much as possible, developments should have a unique identity and sense of place whilst respecting the character of the surrounding context.
- j) Developments should be designed in a way that provides an appropriate level of on-site amenity through the use of landscaping and communal open space, building placement and maintenance of privacy.
- k) Access arrangements should be carefully considered, including the provision of rear access lanes and ensuring garages do not visually dominate.
- g) Developments should ensure an integrated service space is provided and that it is easily accessible.

1.4.3 Medium-Density Residential Design Guidelines

1.4.3.1 Purpose

These design guidelines are developed to assist groups, professionals, and Council to prepare and assess resource consent applications for medium-density residential.

1.4.3.2 How to Use the Design Guidelines

These guidelines form part of the assessment criteria for Comprehensive Development Plans along with applications for development occurring after the implementation of the Comprehensive Development Plan (CDP). A resource consent application is required for each area.

The guidelines have been incorporated as assessment criteria rather than performance standards as they are more of a guide than an absolute standard that must be adhered to. Refer to Chapter 1 – Plan Overview, Section 1.1.4f iii Design Guides.

There are two steps to consider when preparing a CDP. Firstly, there are a number of specific design guidelines which outline basic bulk and location requirements. Secondly, the application should be assessed against the urban design principles outlined in the Design Guide.

For clarity, these rules do not apply to development in the Rotokauri North Structure Plan area, as all bulk and location requirements for the Rotokauri North Medium Density Zone are contained in Chapter 4 Residential Zones.

Proposed Plan Change 7:
Rotokauri North Private
Plan Change - Notified
Version

1.4.3.3 Site Coverage

a) Site coverage	Up to 50%
------------------	-----------

1.4.3.4 Permeable Surfaces

a) Net site permeability	At least 20% of the net site area. The front yard requirements are to be included in this percentage.
b) Front sites only: Permeability forward of the building line of the dwelling planted in grass, shrubs and trees	At least 50%

1.4.3.5 Building Height

a) Height of buildings	Up to 12.5m
------------------------	-------------

1.4.3.6 Building Setbacks

Building setback from	Minimum distance
a) Transport corridor boundary – local and collector transport corridors	3m
b) Transport corridor boundary – arterial transport corridors Except that any garage or carport facing the transport corridor should be set back a minimum of 8m	5m
c) Waikato Expressway (Designation E90 and E90a)	i. 35m from the designation boundary, or ii. 40m from the actual carriageway edge of the Waikato Expressway if: <ol style="list-style-type: none"> 1. The location of the carriageway within the designation corridor of the Waikato Expressway has been confirmed in writing by the Requiring Authority, or 2. Construction is underway or completed.
d) Boundary of a Comprehensive Development Area or zone boundary	1.5m

1.4.3.7 Water Management

- a) Rainwater storage devices for the supply of non-potable water for outdoor use and indoor toilets, and for the purpose of stormwater soakage or detention, should be provided.

1.4.3.8 Interface Between Public and Private

- a) The front wall of all accessory buildings that are detached (including carports and garages) and an integral part of the design and construction of the dwelling, should be:
- i. Located no further forward of the front building line of the dwelling than 0.5m if the garage door is to face the street;
 - ii. Located forward of the front line of the dwelling (but not encroaching into the front setback) by no more than 8m if the garage door is 90 degrees to the street;
- b) At least one principal room should have a clear-glazed window facing the street. For corner sites and sites with two transport corridor frontages, this is required only on the transport corridor frontage from which vehicular access is provided.

1.4.3.9 Fences

- a) All fences should have a maximum height of 1.8m except for those adjoining an open space zone (refer to 15.4.6).

1.4.3.10 Residential Buildings – Separation and Privacy

- a) Residential buildings should maintain an appropriate set back from the nearest part of any other residential building, except:

- i. No separation is required between buildings that are attached.
- ii. Where windows are located and designed (including by glazing) to avoid views between rooms in different buildings, the separation distance could be reduced.
- b) To ensure privacy, any balcony at upper-floor level should be appropriately set back from adjacent residential buildings. This does not apply along a transport corridor, access way, right-of-way, private way, access lot, or entrance strip less than 6m wide.

1.4.3.11 Outdoor Living Area

- a) Each residential unit, except for when a communal area is provided, should be provided with an outdoor living area that is:
 - i. For the exclusive use of each residential unit.
 - ii. Readily accessible from a living area inside the residential unit.
 - iii. Free of driveways, manoeuvring areas, parking spaces, accessory buildings and service areas.
 - iv. Located on a side of the residential unit which faces north, east or west.
- b) Outdoor living areas for residential units to have areas and dimensions as follows.

Residential units	Outdoor living area per residential unit	Shape
i. Single dwellings, duplex dwellings and dwellings in comprehensive residential developments	40m ²	Capable of containing a 6m-diameter circle
ii. Ancillary residential units	12m ²	No dimension less than 2.5m
iii. Apartments	12m ²	No dimension less than 2.5m

- c) The outdoor living area for an ancillary residential unit should be separate from the outdoor living area provided for the principal residential unit.

Note

1. Any communal open space is optional and is additional to the above provisions.

1.4.3.12 Service Areas

Description	Minimum requirements
a) Single dwellings, duplex dwellings and dwellings in comprehensive residential developments	20m ² Minimum dimension 3m
b) Service area per ancillary residential unit	Additional 10m ² Minimum dimension 2.5m
c) Apartments	10m ² Minimum dimension 2.5m
d) All service areas	Readily accessible from each residential unit Not visible from a public place

1.4.4 Rototuna Town Centre Design Guide

1.4.4.1 Purpose

This design guide was developed to assist groups, professionals and Council to prepare and assess resource consent applications for Comprehensive Development Plans (CDPs) and resource consent applications for development occurring after the implementation of the CDP (refer to Volume 1, Rule 13.5c).

A Concept Plan (Appendix 7, Figure 7-1) has been prepared for the Rototuna Town Centre. The Rototuna Town Centre Concept Plan provides a design-led framework for the development of the Centre. The Rototuna Town Centre Concept Plan comprises several activity precincts. The Concept Plan identifies the location and extent of land use types and other essential features including:

- i. The main street and other streets,
- ii. The public square, and
- iii. Community and open space elements.

All development in the Rototuna Town Centre Zone:

- i. Will have a strong emphasis on urban design considerations.
- ii. Must demonstrate that urban design principles have been applied.
- iii. Must be in general accordance with the Rototuna Town Centre Concept Plan.
- iv. Must be designed in accordance with this Guide. To achieve this, before commencing development within the Rototuna Town Centre Zone, a Comprehensive Development Plan (land use consent) must be prepared and approved for each of the Comprehensive Development Areas identified in Appendix 7, Figure 7-2.

1.4.4.2 How to Use the Design Guide

The Design Guide contains four parts.

- i. Part 1: The Overall Concept (refer to 1.4.4.3).
- ii. Part 2: Guidelines relating to the Rototuna Town Centre (refer to 1.4.4.4).
- iii. Part 3: General Principles for Comprehensive Development Plans (refer to 1.4.4.5).
- iv. Part 4: Principles and Assessment Criteria for Precincts (refer to 1.4.4.6).

There are three steps to using this Guide when preparing a Comprehensive Development Plan. Firstly, there are a number of guidelines which clearly outline Council's expectations for achieving high quality design, set out in Sections 1.4.4.4. Secondly, the application should be assessed against the general principles which are outlined in Section 1.4.4.5, and thirdly, the application should be considered in terms of the relevant assessment criteria for the precinct/area in Section 1.4.4.6.

There is a degree of flexibility, and the standards may not be appropriate in every instance. In such cases it must be demonstrated that design flexibility is warranted through the creation of an equivalent or better outcome.

1.4.4.3 Part 1: The Overall Concept

Vision

A Town Centre for Rototuna that functions as a focal point for the wider Rototuna community by enabling a diverse range of activities that operate within a pedestrian-focused, street-based layout, and incorporate principles of good urban design.

Key Features

The key features of the Rototuna Town Centre are:

a) The Main Street

The Main Street provides the central core of the retail area with a traditional street-based layout which is intended to be a pedestrian focused, vibrant shopping destination for the local community. Primary and secondary frontage areas are identified in Appendix 7, Figure 7-3, to facilitate active frontages with buildings closely relating to the street. Pedestrian orientated activities will be encouraged along these frontages, particularly along the Main Street and Public Square which are to be the principal shopping areas.

The carriageway should accommodate cyclists, buses and motor vehicles. There should be wide pedestrian walkways on either side of the carriageway to provide space for street-side dining, parking bays and large specimen trees. The street will be a slow speed environment. The street should have a clear and distinguishing landscaping treatment (streetscape design) applied, to highlight its importance and add to its character, identity and legibility.

The CDP for the Comprehensive Development Plan Areas will include an Integrated Transport Assessment to determine the nature of the intersections at (as relevant):

- i. Borman Road/North City Road.
- ii. North City Road/Park Lane/Suburban Collector Roads.
- iii. Suburban Collector Roads/Local Streets.
- iv. Suburban Collector Roads/Residential Collector Roads.
- v. Midblock access for Public Square, Pool & Library.

The intersection treatments should also consider the pedestrian and cyclist provision to ensure a safe environment and high level of connectivity occurs.

b) The Public Square

The Public Square is designed to be an important public space where markets, fairs and special events can be held. The library and retail areas will open onto the Square. It can be accessed from the Main Street and from walkways and cycleways through the adjoining watercourse and drainage reserve.

The Square should contain key amenity features such as lighting, seating, trees, landscape features and public art. The design should incorporate on the eastern edge the entrance space for the library and other small businesses such as cafés – including space for outdoor dining. A consistent design theme and materials should be used throughout the Square.

c) The Gateways

Key gateway features such as public art at the entrances to the Town Centre from the arterial roads would identify the Centre and contribute to its sense of place. A gateway feature could take a variety of forms or elements (e.g. public art, gantry, landscaping). The carriageway/building design at these key entrance points should be flexible enough to allow a gateway feature to be incorporated into the design.

d) The Watercourse

A central unifying feature of the Town Centre is the drainage reserve/central watercourse which has a principal stormwater function but also provides a key green corridor and walkway/cycleway link. It is important that the waterway and associated corridor is designed as a high amenity, multifunctional feature. To the north, the watercourse will connect with the Active Recreation Reserve and provide a green edge to the playing fields and the secondary school. This green edge will also accommodate shared pedestrian and cycle routes that will connect with parks and footpaths in nearby neighbourhoods.

The precise form and function of the watercourse and corridor will be determined by hydrological requirements and controls. This watercourse will be the principal secondary flow path for the concept plan area, and be sized to accommodate 1% annual exceedance probability storm flood conditions.

e) Park Lane

Park Lane runs along the eastern edge of the Active Recreation Reserve and will provide access to the Reserve and adjacent Residential High Density Precinct. The combination of the housing and lane will provide increased surveillance over the Reserve.

Park Lane should be designed as a slow moving lane, with a number of traffic calming measures incorporated into the design. Provision should be made for angled parking adjacent to the park, and berms for landscaping. Its character should be that of a tree-lined lane within a residential environment.

f) Passenger Transport

Passenger transport within the Town Centre should be catered for via integrated bus stops within the transport corridor carriageway.

A transport interchange opposite the Public Square on the Main Street should be provided. The interchange is central to the Concept Plan. It will bring people directly to the heart of the Town Centre and will improve the general surveillance and safety around the Public Square.

g) Connectivity

In order to achieve a legible and efficient transport network it is essential that all nodes are well connected both internally and to other nodes. The local nodes and Town Centre in particular shall be well connected to the surrounding residential neighbourhood they serve.

h) Walkways/Cycleways

The emphasis in and around the Town Centre is on achieving good walking and cycling connectivity. Effective connections to the Centre must be provided from the adjoining residential areas. The central drainage reserve/water course must

incorporate walking and cycling paths, offering good connectivity with the Active Recreation Reserve, community facilities and schools, and to the southwest along existing walkways/cycleways.

i) Primary/Secondary Frontages

Primary and secondary frontages have been identified where the interface between buildings and the street or public space is considered particularly important. Along these edges at ground floor level, retail activity should predominate and buildings must relate closely to the street – providing activity, interest and vitality.

Precincts

As shown on the Concept Plan, the Rototuna Town Centre is made up of several activity precincts that contribute to the overall function of the Centre. These include:

a) Retail Precinct

The Concept Plan provides for two distinct retail areas – Retail Precincts 1 and 2.

The Retail 1 Precinct has frontage to the Main Street and Public Square and adjoins the proposed library and aquatic centre. Within this Precinct, the scale and form of the buildings and shopfronts should respond to and reflect the pedestrian nature of the streetscape. Retail should be of a fine grain and typically include small shops of a maximum floor area of 400m², restaurants and cafés. Offices and apartments should be located above ground floor level. Activities provided for in this precinct include entertainment, restaurants, cafes, takeaways and small store retailing.

In the Retail 2 Precinct, which is located immediately to the west of the Main Street, the Concept Plan provides for larger scale retail activities to serve the local community. Development should, however, still provide an active frontage to the street – either through a main entrance or by sleeving the development with smaller retail outlets.

b) Employment Precinct

It is intended that this centre have a strong employment base, and areas for business and light industry are identified on the Concept Plan. Employment based activities should not interrupt or conflict with shopping activities or more sensitive uses in adjacent precincts. Appropriate locations are therefore shown to the north of the Retail 2 Precinct and close to the major arterial road.

The Employment Precinct will provide for light industry and service type activities to predominantly meet the needs of local residents. Light industry activities include vehicle servicing and repair activities, small scale home improvement activities, electronic and computer repairs and service, small scale manufacturing, cleaning services, food preparation, catering, printing and storage.

c) Residential Mixed Use Precinct

The Residential Mixed Use Precinct will act as a transition area between retail and residential development. The Precinct predominantly provides for residential activities, however a limited amount of office development, service industry, small retailing and activities that will not compromise residential living amenity levels are also provided for.

d) Residential High/Medium Density Precinct

Residential High Density and Residential Medium Density Precincts form part of the Town Centre. These precincts are intended to provide a population base to support the Centre's retail, employment, entertainment, community and recreational activities and enhance its vitality and vibrancy. Conversely, the Centre will provide goods and services for the local residential catchment. It is therefore important that residential land is developed to a sufficient density to enable these mutual benefits, and to ensure efficient use of the land resource.

e) Community Precinct

In addition to the planned community facilities described below, land has been set aside for other community facilities such as community centres, education and training facilities and health care services.

Library – The proposed new library will occupy a key central site within the Town Centre having frontages onto both the Public Square and the watercourse. Ideally this will be designed as a high quality, innovative building.

Aquatic Centre – The aquatic centre is strategically located between the Retail 1 Precinct and Active Recreation Reserve. This will enable shared use of facilities such as changing rooms and carparking space. As with the library, this building should be of high quality and innovative design.

Schools – A new primary school and a new secondary school will contribute to the overall Town Centre 'node'. Both schools are within a 10 minute walk of the heart of the Centre. The schools are to be zoned Community Facilities and do not form part of the Concept Plan.

Apostolic Church – There is an existing church on North City Road. This existing use will be acknowledged by identifying the land as a Community Facilities Precinct.

Parks and Green Space

A large recreation reserve is centrally located in the Town Centre and in close proximity to the aquatic centre and schools. The reserve will provide for playing fields, one of which may be served by a stand, together with other facilities such as courts, cricket ovals and potentially floodlighting. Transport corridors and high density residential developments are planned around the perimeter, offering good views into the reserve. In turn this will increase passive surveillance and overall safety, and provide open space and amenity for residents.

1.4.4.4 Part 2: Guidelines for the Rototuna Town Centre

a) Building Height

Building height standards for each Precinct are as follows.

Precinct	Maximum Building Height	Minimum Building Height	Minimum Storeys
Retail 1 and Retail 2	15m	8m Primary frontage	2 in Primary Frontage

Precinct	Maximum Building Height	Minimum Building Height	Minimum Storeys
Community	15m	8m Primary frontage	2 in Primary Frontage
Employment	6m	-	-
Active Recreation	i. 8m, except public toilets adjoining a transport corridor boundary where the maximum height shall be 3m ii. Maximum height of any floodlighting shall be 15m	-	-
Public Square	-	-	-
Residential Mixed Use	12.5m	-	-
Residential High Density	12.5m	-	-
Residential Medium Density	12.5m	-	-

b) Separation Distances and Privacy

- i. Where two or more buildings, excluding accessory buildings, are located on the one site, no eaves of a building shall be located closer than 3m from the eaves of another building.
- ii. A balcony or window of a habitable room at upper-floor level shall be set back 5m from any boundary of a Comprehensive Development Area, zone boundary, precinct boundary, or public open space, excluding the road boundary or adjoining an accessway, any entrance strip with a width of 6m or less, or any right of way, private way or access lot.
- iii. Where buildings are attached, no setback is required between those buildings.
- iv. Separation distances may be reduced where:
 - Windows are at an angle of 60° or greater to the boundary, or
 - Window sill height from the finished upper-floor level is 1.7m, or
 - Opaque or obscure glazing is provided.

c) Building Setbacks

Building setback standards for each Precinct are as follows:

Precinct	Maximum Building Setback from Transport Corridor	Minimum Building Setback from Transport Corridor	Minimum Building Setback from side, and rear boundary
Retail 1 and Retail 2	<ul style="list-style-type: none"> • 0m Primary frontage 	0m	

Precinct	Maximum Building Setback from Transport Corridor	Minimum Building Setback from Transport Corridor	Minimum Building Setback from side, and rear boundary
	<ul style="list-style-type: none"> 0m Secondary frontage No maximum elsewhere 		
Community	<ul style="list-style-type: none"> 0m Primary frontage 0m Secondary frontage No maximum elsewhere 	0m Primary frontage 5m front	Refer Volume 1, Rule 16.4.4 Where site adjoins the Residential or Special Character Zone or a Residential Precinct – 3m
Employment	10m	5m	5m
Active Recreation	-	5m except public toilets which may be sited up to the transport corridor boundary	5m from the boundary of any Residential Precinct
Public Square	-	-	-
Residential Mixed Use	<ul style="list-style-type: none"> 0m Primary frontage 0m Secondary frontage No maximum elsewhere 	0m	
Residential High Density	5m	1m	1.5m where adjoining another precinct, CDP Area or zone boundary
Residential Medium Density	No maximum	i. 3m from the boundary of a local/collector transport corridor ii. 5m from the boundary of an arterial transport corridor	1.5m where adjoining another precinct, CDP Area or zone boundary

d) Development Intensity

Development Intensity for each precinct shall be as follows.

Precinct	Maximum Floor Area Ratio	Maximum Site Coverage
Retail 1	3:1	100%

Retail 2	3:1	100%
Community	2:1	100%
Employment	1:1	75%
Public Square	NA	NA
Residential Mixed Use	2:1	100%
Residential High Density	NA	50%
Residential Medium Density	NA	50%

e) Primary Frontages

For buildings within the Primary Frontages as defined in Appendix 7, Figure 7-3:

- i. Buildings shall include a minimum of 2 stories of useable floor space.
- ii. A minimum of 75% of ground floor wall facing the street or public space, for the length of the ground floor wall, shall be of clear glass and capable of being used for displaying goods and services to passing pedestrians.
- iii. Ground floor tenancies shall have the main customer entrance facing the street.
- iv. A continuous veranda not less than 2.5m deep shall be provided which extends along the full street frontage except that no veranda over a footpath may encroach to within 600mm from the kerb. Verandas should be designed to provide continuous pedestrian cover so they abut one another.
- v. There shall be no vehicle access, parking or service areas within the Primary Frontage Area.

f) Secondary Frontages

For buildings within the Secondary Frontages as defined in Appendix 7, Figure 7-3:

- i. A minimum of 50% of the ground floor wall facing the street or public space, for the length of the ground floor wall, shall be of clear glass and capable of being used for displaying goods and services to passing pedestrians.
- ii. Ground floor tenancies shall have the main customer entrance facing the street.
- iii. There shall be no parking or service areas within the Secondary Frontage Area.

g) Outdoor Living Area

Each Residential Unit or any residential accommodation associated with non-residential activities shall be provided with an outdoor living area which:

- i. Shall be for the exclusive use of the Residential Unit.
- ii. Shall be readily accessible from a living area of a Residential Unit.
- iii. Shall be free of driveways, manoeuvring area, parking spaces, accessory buildings, and service areas.
- iv. Shall have a minimum area per Residential Unit of 12m², and a minimum dimension of 2.5m width.

Note

1. Any communal outdoor living is optional, and shall be provided in addition to the above provisions.

h) Service Area

Each Residential Unit or any residential accommodation associated with non-residential activities shall be provided with service areas as follows.

- i. A minimum service area of 10m² with a minimum dimension of 2.5m located at ground floor level, and readily accessible to that residential accommodation.
- ii. The service area shall be maintained with an all-weather, dust free surface.
- iii. The vehicular access associated with a service area may not be located within a primary or secondary frontage.
- iv. A service area shall not be able to be viewed from a public space.
- v. The service area required under this rule shall be additional to the service area required under Volume 1, Chapter 13: Rototuna Town Centre, Rule 13.8.5.

i) Communal Outdoor Space

Any Residential Accommodation that does not constitute a Residential Unit (e.g. hostels, and motels), and all Visitor Accommodation shall provide a Communal Outdoor Living Area for each building which:

- i. Has a minimum area which shall be equal to 12m² multiplied by the number of Residential Units or 12% of the gross leasable area of that part of any building occupied by residential accommodation, whichever is the greater.
- ii. Has a minimum dimension of not less than 4m.
- iii. Is capable of containing a circle not less than 8m in diameter.
- iv. Is readily accessible to those parts of any buildings occupied by Residential Activities.

1.4.4.5 Part 3: General Principles for Comprehensive Development Plans

Principle

Development of the Rototuna Town Centre shall be undertaken in accordance with a CDP to be approved by Council for the individual Areas shown in Appendix 7, Figure 7-2.

Explanation

An application for a CDP needs to address the following.

- a) The overall design of the Rototuna Town Centre achieves aesthetic and architectural coherence, and is of a design, scale, form and character appropriate to its unique location.
- b) The arrangement of buildings, car parking, service areas, and open spaces including provision for vehicular, cycle and pedestrian circulation will:
 - i. Enable the establishment of activities that are appropriate for the comfort, and convenience of visitors to the Rototuna Suburban Centre, and the local community.
 - ii. Be safe, and convenient, and achieve high standards of amenity.

- iii. Be functionally linked with, and physically connected by, walkways/cycleways to the suburban centre.
- iv. Reinforce high quality urban design, particularly the orientation of buildings to outdoor public spaces, transport corridors, and utilising a variety of architectural elements.
- v. Provide for appropriate public access (pedestrian and cyclists) to, and around the area.
- vi. Provide direct access paths on the most well-used routes with appropriate lighting, landscaping, and seating.
- vii. Buildings shall be constructed from solid and durable materials to ensure a high standard of aesthetic coherence, and amenity consistent with the aim of providing an attractive suburban centre.

c) Design and layout of transport corridors

- i. To ensure appropriate connections to existing, and future transport corridors.
- ii. Respond to the site's existing landform, vegetation, views, water courses (for the purposes of stormwater runoff), and areas of public open space.
- iii. Accommodate safe traffic speeds, and sightlines for all transport corridors users (pedestrians, cyclists, and motorists).
- iv. Provide sufficient width to safely accommodate all transport corridor users, parking, footpaths, cycle ways and amenity landscaping.
- v. Promote a consistent design theme to achieve high amenity values.
- vi. Have regard to the future design relationship between the transport corridors, adjoining land and adjacent precincts.
- vii. Design guidance for transport corridors can be found in Appendix 15-6: Criteria for the Form of Transport Corridors, and the Hamilton City Infrastructure Technical Specifications.

d) Type, form, and density of housing

Whether future development sites have been identified in a manner that:

- i. Responds to the context within which the development site is to be located, including roads, open space, pedestrian linkages, views and natural features.
- ii. Is appropriate to the type, and form of housing (medium density or high density).
- iii. Is in accordance with policies and rules in Volume 1, Chapter 13: Rototuna Town Centre Zone, setting out the required yield for the various precincts.
- iv. Has regard to the relationship with existing developed areas.
- v. Gives consideration to the size, shape and aspect of the land, and its suitability for future development, with particular regard to the relationship of the site to the transport corridor, and adjoining sites.
- vi. Integrates the development of sites with the relevant precinct as a whole.

1.4.4.6 Part 4: Principles and Assessment Criteria for Precincts

a) Retail Precinct 1

Principle

The Retail 1 precinct faces onto the Main Street and Public Square, and adjoins the proposed library and aquatic centre. This is the main shopping area within the centre and activities have been specifically selected to create a vibrant and vital centre. It is therefore important that there is a continuity of buildings facing onto the street and that they have 'active' frontages. This coupled with the range of activities and public realm elements (footpaths, lighting, landscaping, street furniture, open space, etc) play an important role in creating an attractive and thriving Town Centre.

Figure 1.4.4a: Main shopping street



Explanation

The intent is to create a community focal point providing employment, shopping, recreation and passenger transport opportunities for a locally-based population. A key consideration is the creation of a local identity for Rototuna's main retail area. The centre's design needs to be of a high quality so that people want to shop, linger, live, work and play within its environs. Therefore the setting needs to be safe, attractive, comfortable, accessible and durable. This is achieved by ensuring that buildings have 'active' street frontages. The scale and form of buildings should be of a fine grain and designed to reflect the street's pedestrian focus.

It is envisaged that buildings within this part of Rototuna will be a minimum of two levels. Residential activities must be able to protect themselves from adjacent activities namely restaurants, bars (licensed premises) and bakeries, as these activities operate at a time when they may disturb residents. One key consideration is the protection of business land in, and around, this centre. Locations that work for businesses are fewer than for residential.

Assessment Criteria

1. Active Street Frontages

Active street frontages add interest, life and vitality to the public realm. This means:

- i. Buildings must contain street level activity, along with frequent doors, windows and few blank walls, which allows a visual connection between people within the building, and those on the street.
- ii. Shop frontages should be narrow to provide frequent changes in use and add visual interest.
- iii. Building entries need to be clearly identifiable, face onto the street and be at the same level as the street.

Figure 1.4.4b: Active street frontages

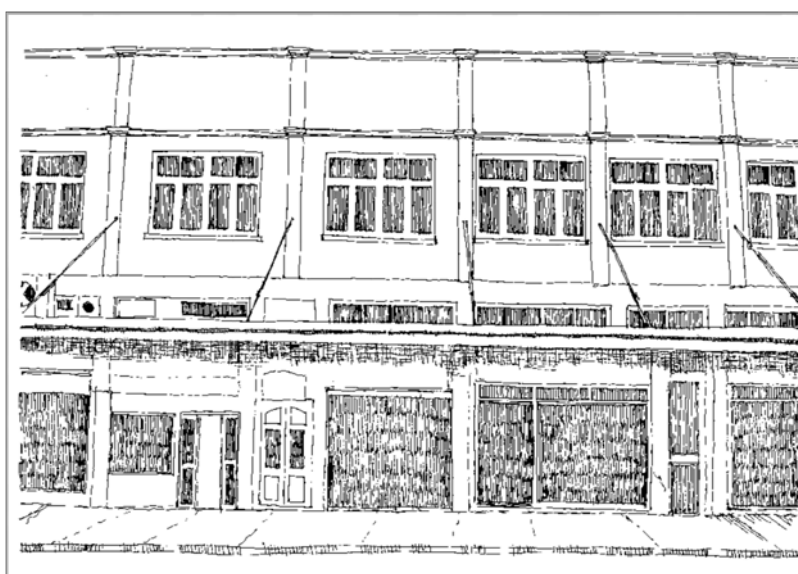

2. Building Design – Form and Appearance

Building design defines the public realm while setting the scene for character and form including window, door proportion and placement. This means:

High quality design

- i. Buildings should be designed to be of a high quality and help create a unique identity and character.
- ii. Durable materials should be used.

Building continuity

- iii. Buildings need to be designed so that they line both sides of the street. Minor modulation to the building's frontage is acceptable (including pedestrian entrances, windows, bay windows, etc) provided street front continuity is not compromised.

Corner buildings

- iv. Where buildings are located on street corners (intersection of two streets) architectural details should be used to emphasise and address the street corner.

Passive surveillance

- v. Buildings should be designed so that their occupants can overlook the street and public open space.

Figure 1.4.4c: Passive surveillance

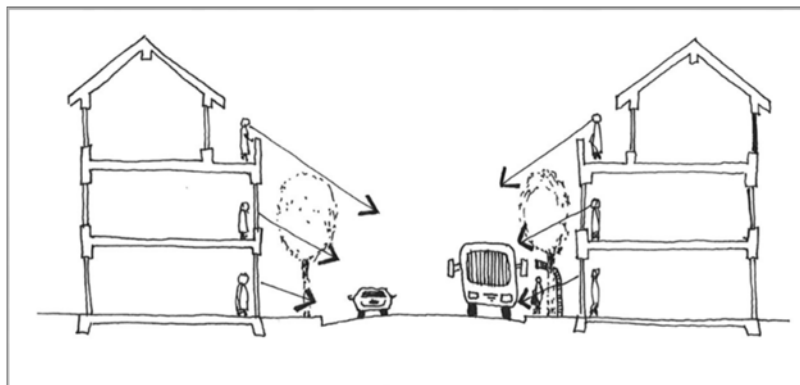
*Public access*

- vi. Buildings facing onto open space are required to create openings so people can access such buildings from open space areas.
- vii. Access into buildings should be at grade for both pedestrians and vehicles, to reduce the need for pedestrians to negotiate changes in footpath grade.

Building façades

- viii. Building façades should incorporate the following features.
 - Articulation, celebration of main building entrances, use of projections such as bays and balconies.

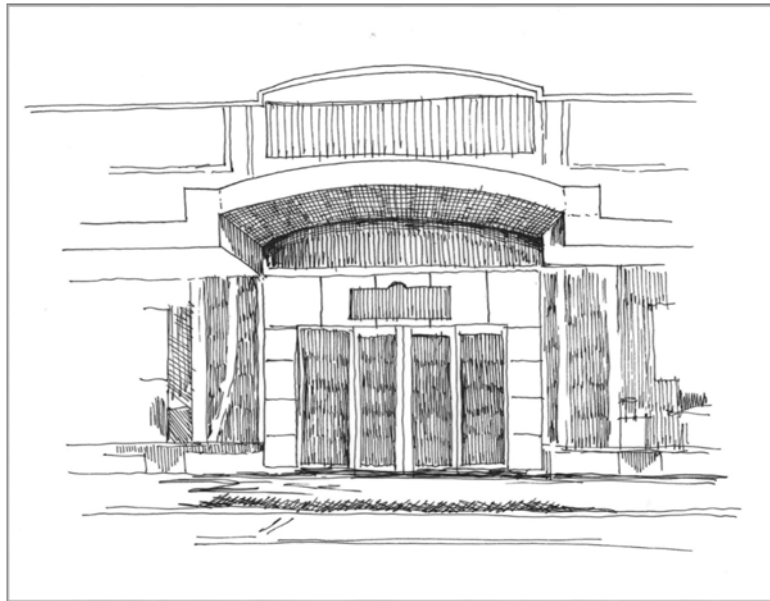
Figure 1.4.4d: Building façades

- Narrow building frontages – this gives the street scene a vertical as opposed to a horizontal emphasis.
- Variation in materials, colour, window shape and size to accentuate and highlight features.
- Use eaves, and window sills to create interest for street users.
- Car parking and service entries need to be designed so they have a minimal effect on building continuity, where possible using rear lanes and access ways.
- Use architectural details to differentiate building levels, e.g. the building's ground, middle and upper levels.
- Blank façades which are visible from public spaces are inappropriate.

Rooftops

- ix. Integrate lift plant, and mechanical services into the building's roof so they are not visible from public spaces.
- x. Orientate satellite dishes, telecommunication antennae, and air conditioning units so they are not visible from public spaces.
- xi. Use a variety of roof forms to provide visual interest. Sections of long horizontal 'flat' roofs are inappropriate.

Acoustic amenity

- xii. Apartment buildings need to be designed so that residents are not disturbed by street noise or from neighbouring residents.

b) Retail Precinct 2:

Principle

This Precinct is separated from the Retail 1 Precinct by a proposed drainage reserve containing a watercourse. The Retail 1 Precinct contains similar land uses to the Retail 1 Precinct. The main difference is that provision is made for larger format retailing in Retail 2.

Explanation

It is still preferable that buildings provide an active frontage to the street, either through a main entrance or by sleeving the development with smaller retail outlets.

Assessment Criteria

The same assessment criteria for Retail 1 also applies to the Retail 2 area. For larger scale buildings, use should be made of the Employment Precinct assessment criteria outlined below.

c) Employment Precinct:**Principle**

The Employment Precinct provides opportunity for business, and light industry. In certain instances it may be necessary to buffer this precinct from adjacent residential areas.

Explanation

Employment Precinct land will not provide the level of amenity found within the Retail 1, and 2 zones. However these zones will be used by Town Centre workers, and visitors, and pedestrians walking from areas beyond it.

Front Façades, and Entrances

Business buildings are often of a larger scale, and can therefore potentially create adverse effects due to the traffic they attract, e.g. conflicts between visitors, staff, and service based vehicles. Due to their size these buildings can often have large blank façades making it difficult to create an attractive street scene.

Assessment Criteria

- i. Site entrances need to be obvious, and located next to vehicular and pedestrian entrances from the street.
- ii. Pedestrian walkways should be provided directly from the public footpath to the building's front door.
- iii. Buildings should make a positive connection with the street. This can be achieved by designing buildings so they present a narrow face to the street and locating building mass away from the frontage.

Figure 1.4.4e: Example light industry

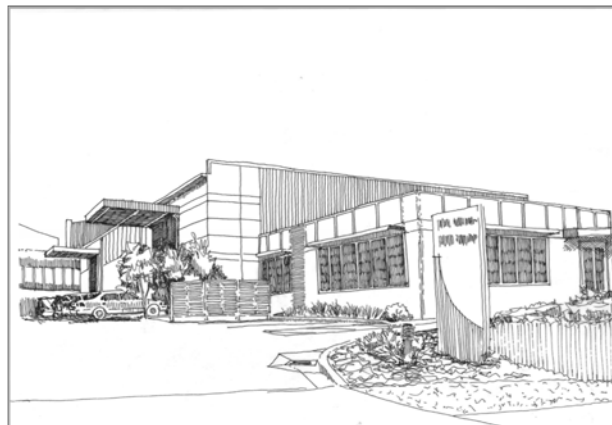

- iv. Signage should be minimal, and clear – the focus should be on business identification rather than promotion of goods and services.
- v. Office components should be located towards the building's front, since this minimises vehicle/pedestrian conflicts.
- vi. Corner buildings – refer Retail Area 1 buildings.

Loading and servicing

- vii. Storage areas should be located at the rear or side of buildings, and ensure that they are screened from the street, so that the collection of rubbish, waste products, and goods cannot be viewed from the street.
- viii. Car parking should be located at the side or near the front of buildings, as these areas need to be visible from the street so that visitors do not enter unsafe or hazardous areas.

Landscaping

- ix. Use landscaping to help soften the appearance of large buildings, provide amenity, and screen loading, and service areas.
- x. Where possible use landscaping to mitigate stormwater run-off as this helps to reduce the need for piped infrastructure.
- xi. Use landscaping to provide visual relief to areas of car parking.

Buffers

In certain circumstances, it may be necessary to buffer employment activity to protect the adjacent residential areas. Buffers generally consist of a physical element that acts as a barrier, screening device or shield between quiet areas, and noise producing areas of a single development. Buffers are essential in that they help maintain good levels of noise and visual privacy, thereby providing an acceptable degree of amenity for all occupants.

Examples of buffers include:

- Physical distance – a space or courtyard separating employment and residential uses to sufficiently protect residents from the noise source.
- Structural element – a well insulated exterior wall may minimise noise transmission between buildings. Similarly horizontal separation between activities such as commercial, offices, and upper residential floors.

Landscape feature

Trees/vegetation can be used as a buffer. Other landscape buffers include: ground level changes along with planting to create 'screens' or 'shields'.

d) Residential Mixed-use Precinct

Principle

An area of residential mixed-use has been incorporated into the concept plan to further encourage choice and diversity. When designing mixed-use development it is important to ensure that buildings can accommodate a range of different uses, as these can change over time.

Explanation

Mixed-use development needs to provide a degree of flexibility so that the buildings can respond to changes in demand whether this is office, residential or retail. Such development can encourage people to use the centre outside the working day. Business activity helps to create vibrancy and life including 24- hour occupancy of buildings.

Assessment Criteria

- i. Residential entries need to be clearly demarcated and separated from business entries.
- ii. Separate business loading docks and waste storage areas from residential access.
- iii. Ensure that the design of residential units recognises the needs for servicing, privacy and outlook, and that this is not compromised by business activities.
- iv. Consider acoustic privacy. The design needs to specifically address this issue demonstrating that an acceptable residential living environment can be created and maintained.

Figure 1.4.4f: Example mixed-use development



e) **Residential Medium Density – in the Rototuna Town Centre Medium Density Precinct**

Principle

Medium density housing typically consists of a mix of detached and terraced type housing.

Explanation

Housing lots at medium densities typically deliver around 25 units per hectare, and typically comprise a mix of single dwellings located on single sites and terraced dwellings. There are important amenity considerations associated with this development form. For example how buildings address the street and how they create visual interest.

Figure 1.4.4g: Example medium density housing**Assessment Criteria**

- i. Buildings need to be designed to form a positive relationship with the street so that:
 - They provide for streetscape amenity, through the careful placement of entry doors, windows, porches, balconies, entry courtyards as these attributes help to create an active frontage to the street.
 - They demonstrate the transition between the street (public realm), the building's front yard (semi-public realm) and the building's private rear yard.
 - Visitors know how to access the building.
- ii. Design balconies so that they face onto public space/roads, including a clear outlook of at least 6m which is not of adjacent properties. It is preferable that balconies which face roads be designed as recessed elements so they do not protrude from the face of buildings.
- iii. Site buildings to maximise sunlight into indoor and outdoor areas:
 - Maximise north facing windows.
 - Maximise exposure to private open space e.g. rear yards facing north.
- iv. Make provision within each residential unit for:
 - Collection of recyclable materials and an area for rubbish bins, ensuring they are located and designed not to be visible from the street or other public places.
 - Storage area for outdoor equipment e.g. bicycles, prams, sports equipment etc.
- v. Use landscaping to provide visual interest, create privacy and shelter people from prevailing winds.
- vi. Maximise privacy between dwellings by taking extra care over the interface at the sides of adjacent buildings. This is dependent on each development and local circumstances.

-
- vii. Design buildings so they provide visual interest, diversity and variation. This helps to avoid monotonous repetition of building form including: roof pitches, materials, decks, courtyards, balconies and other detailing.
 - viii. Design buildings to address local conditions including topography, views and climate. Use eaves to control summer sun, provide shelter from rain and shelter courtyards from wind.
 - ix. Avoid locating satellite dishes and clothes lines at the front of buildings. Locate these items so they are not clearly visible from the street.
 - x. Garages and car ports need to be designed and located so that:
 - There is sufficient space to park a car between the site's front boundary and the front of the garage/carport.
 - Garages and carports are set back from the dwelling's main façade.
 - They relate to the building's design in terms of height, roof form, materials, detailing and colours.

f) Residential High Density Precinct

Principle

Within this precinct, the form of development is likely to be comprised of two level apartments or terraced housing. It is preferable that such development faces onto, and overlooks the active recreation reserve.

Explanation

Locating higher density housing within a five minute walk of the Rototuna Town Centre helps increase the probability of people using passenger transport. It also increases the likelihood of people walking to the main street as opposed to taking the car.

Higher density residential housing requires a higher design standard including improved pedestrian and cycle connections to the Town Centre. In Rototuna's case the high density area is located on either side of the Active Recreation Reserve.

With this housing it is important that appropriate scale is maintained to avoid the creation of large monolithic structures similar in appearance to commercial and industrial buildings.

Height needs to be sensitively managed, pitched roofs can assist in this regard. Flat roofs are discouraged as these often give the development a strong horizontal feel and can be monotonous.

The key is to create a degree of variety, and this means using balconies, recesses, and voids, along with careful roof design.

**Figure 1.4.4h: Example of high density housing
Assessment Criteria**



- i. The above criteria for Residential Medium Density housing, namely i, ii, iii, iv, v, vi, viii, and ix.
- ii. For iv above consideration needs to be given to the provision of these items either within an individual building or within an apartment complex.
- iii. Where possible, residential development should front onto and overlook the Active Recreation Reserve.
- iv. Where vehicular access is from the street (at the front of the development) parking bays and garages should be set to the side/rear of buildings.
- v. Rear lane access may also be appropriate to reduce the need for garages located at the development's street front.
- vi. Consider locating car parking areas half a level below ground and placing buildings half a level above. This helps reduce the amount of space taken up by garaging and parking on a given site.
- vii. Use elements such as balconies, recesses, voids, materials, colours and roof design to create variety, such features should be used to reduce building mass.
- viii. Design buildings so they provide a range of accommodation choice in terms of type, style, and size.
- ix. Consider acoustic privacy. The design needs to specifically address this key consideration and demonstrate that an acceptable residential living environment can be created and maintained. This can be achieved by:
 - Placing living rooms of one apartment adjacent to the living rooms of adjacent apartments along with bedrooms next to bedrooms.
 - Locate noise sources such as kitchens, bathrooms and laundries next to noise sources in adjacent apartments.

- Locate vehicle, pedestrian entranceways away from bedroom areas.
- xiii. Avoid locating buildings so that they are perpendicular to the street as this presents an extremely poor street interface and adversely affects the privacy of neighbouring units.

Figure 1.4.4i: Example of high density housing

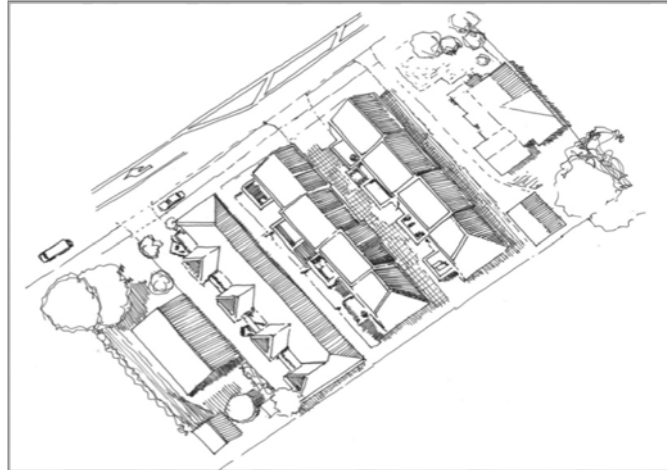

g) Community Facilities

Principle

A feature of the concept plan is the provision of new community facilities, namely a library, aquatic centre and the secondary school (outside the concept plan boundary). This also includes some land which will be privately developed, along with an existing church.

Explanation

The proper integration of these facilities with the movement and activity network is key to ensuring the success of the Rototuna Town Centre. It is envisaged that other community facilities will locate within the centre. Where this occurs it is important that these activities face onto transport corridors, for example Borman Road.

Although these features have not been designed in detail the following general guidelines apply.

Assessment Criteria

i. Library

The library needs to be designed and located so that people will choose to visit because it is easy to use, exciting, modern and comfortable. The following therefore applies.

- The library is envisaged as a landmark building that will occupy a key central site within the centre, adjoining and defining one edge of the public square.
- The library should have active edges towards the public square, the main street to the northeast and the drainage reserve to the northwest. Avoid presenting blank façades to public areas.

- The library's main entrance shall be directly off the public square and the building shall be located to help define the square's southwestern edge.
- The design of the building should focus on facilitating pedestrian movement in, and around, the site.

ii. Aquatic Centre

The aquatic centre calls for the design of the facility to reflect its setting within the Rototuna Town Centre.

Currently, the scope of this project includes the design, construction and commissioning of a new aquatic centre facility, landscape works and parking facilities. A concept design is to be developed for a Community Centre/Recreation facility in conjunction with the concept design for the aquatic centre.

The aquatic centre will be located on North City Road, directly opposite the public square. The following therefore applies.

- The building is envisaged to be a landmark building and will be a significant feature for the centre.
- The building's main entrance shall be located so people can gain direct access from the main street.
- The building's northern and western façades including the changing facility for the active reserve, should be carefully designed to actively engage with the adjacent open spaces.

h) Active Recreation

Principle

Central to the Town Centre is a large active recreation reserve which is intended to be a focal point for the local community. The development of this area is critical to the functioning of the wider area. The detailed design and operation of the reserve will be subject to a Reserve Management Plan, which has yet to be finalised.

Explanation

Good visual and physical connectivity between the reserve and adjoining uses is important. The drainage reserve/watercourse corridor provides a key linking element of this connectivity within the area.

The following therefore applies.

- i. The reserve will be primarily used as an active sports area containing fields and court areas.
- ii. The reserve should be bounded by roads or lanes to ensure effective connectivity and integration.
- iii. The western edge of the park needs to be activated with a shared pedestrian/cycle route.
- iv. The reserve should be designed to be accessible from surrounding dwellings.

- v. The design of the park should enable effective access for pedestrians, cyclists and the disabled.

i) Public Square

Principle

A key feature of the concept is the provision of a key piece of public open space – a public square. Conceptually, this space marks the intersection of the main street and the drainage reserve/watercourse, and links the public library to the aquatic centre (refer concept plan). The square is located north-east of the library, opening out onto the main street.

Explanation

It is envisaged that the square will be a primary gathering and social space for the wider area. The creation of a high quality, functional public space is essential to the vitality of the Town Centre.

Assessment Criteria

- i. The Public Square needs to be designed to accommodate a range of uses and activities, including outdoor dining.
- ii. The Public Square is to be flanked by retail development, the library, drainage reserve and main street. It is important that active edges are provided around the perimeter of this space. A key component is entrances to these activities opening out onto this square.
- iii. The space should contain key amenity features including, lighting, seating, trees/landscaping, public art.
- iv. CPTED principles should be incorporated into the Public Square's design.

Figure 1.4.4j: Example of a public square

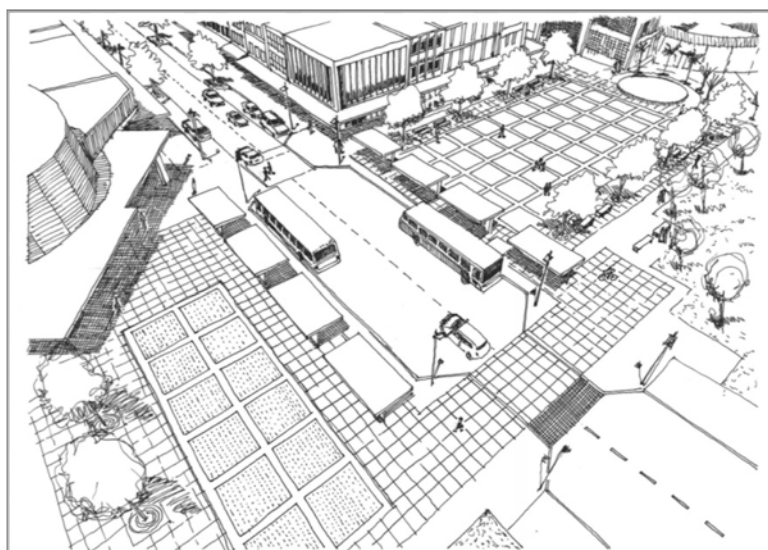

j) Drainage Reserve/Watercourse

Principle

Another unifying feature of the concept plan is the central drainage reserve/watercourse corridor. Its principal function is stormwater management however it also forms part of the open space network catering for pedestrians, and cyclists.

Explanation

It is important that this corridor is designed as a movement corridor, providing a link from the Te Awa O Katapaki esplanade in the southwest to the northern areas of Rototuna. This link will help provide strong connections with the surrounding residential areas for both pedestrians and cyclists.

Furthermore, the concept plan includes a larger green space at its southwestern corner. This space will be particularly visible from the Town Centre and it is therefore important that this vista is maintained and reinforced. From the north the watercourse will link with the active recreation reserve creating a green edge to the playing fields and secondary school.

The precise form and function of this corridor will be determined by hydrological requirements and controls but is likely to become more urban in character as it gets closer to the main street. The following therefore applies.

- i. All buildings that face onto the drainage reserve/watercourse corridor need to be designed so that the ground floor faces onto the drainage reserve/watercourse corridor.
- ii. Fences that line the drainage reserve/watercourse corridor need to be no higher than 1.4m if of a solid construction; if permeable (pool fence or similar) they should be up to but no greater than 1.8m in height.
- iii. The drainage reserve/watercourse corridor needs to be designed and developed to be an attractive landscaped space.
- iv. Entrance and exit points onto the corridor should be aligned to enable connections to be made with the wider pedestrian and cycleway network, and may require bridging of the watercourse.

k) Transport Network

1. Street Design

Principle

The creation of attractive, safe streets which encourage walking/cycling is an important goal. The transport network is required to provide effective movement for all transport modes.

Explanation

A key consideration is the provision for pedestrian and cycle paths. The Town Centre will be promoted as a walkable node to cater for the large number of people anticipated to be living within a 10 minute walk (800m) of its centre.

The concept plan indicates a pedestrian/cycle path along the active reserve's western edge. The link could be reinforced with appropriate landscaping and lighting. This link will provide good connectivity to the north side of the site whilst providing an effective linkage to schools and the bus interchange.

The Rotorua Town Centre comprises minor collector and major arterial transport corridors which will be designed in accordance with the guidance in Appendix 15-6, and the Hamilton City Infrastructure Technical Specifications. This concept contains three main types of street; these are the Main Street, Park Lane and local streets. The following guidelines apply to the three street typologies.

Main Street

- i. North City Road is to be designed to function as the Town Centre's main street.
- ii. The carriageway needs to accommodate buses, cars and cyclists, and be designed so these uses can safely co-exist with one another. Footpaths need to be sufficiently wide to provide for pedestrians along with opportunities for street-side dining.
- iii. Parking should be accommodated along with large structure trees within the parking area.
- iv. The street should be designed to create a low speed environment.
- v. All crossing points should be at grade.
- vi. Develop a 'shared street' concept (where pedestrians have priority) in conjunction with the passenger transport interchange.

Park Lane

- vii. The Lane's primary function is to provide access to the active recreation reserve and adjacent residential development.
- viii. Park Lane must provide a strong interface with the edge of the recreation reserve.
- ix. The street must be designed to have a low speed environment.
- x. A shared pedestrian/cycle path needs to be provided along the edge of the recreation reserve.
- xi. Angled parking should be provided along the edge of the recreation reserve, along with planted berms (containing large specimen trees).
- xii. Design safe pedestrian/cycle access ways to the schools.

Local Streets

- xiii. These streets are intended to provide connections to other areas of the Town Centre.
- xiv. The carriageway needs to be designed to accommodate vehicles, cyclists and pedestrians, and to include parking (angle and parallel) along with provision for service vehicles. Paved pavement areas need to be provided on both sides of the street.
- xv. Landscaping is to include large specimen trees on either side of these streets.

2. Car Parking

Principle

An adequate number of parking spaces needs to be provided to enable the Town Centre to function effectively.

Explanation

Parking provision that is not carefully integrated with the surrounding buildings has the potential to disrupt the centre's pedestrian-friendly nature and compact urban form.

The following therefore applies.

- i. Large open parking areas should be avoided, especially along primary and secondary street frontages as this can disrupt building continuity.
- ii. Parking areas should be located at the rear or side of development or towards the centre's perimeter.
- iii. Shared parking should be promoted so it can be used by a multitude of users rather than those visiting a single building.
- iv. Multi-level parking buildings should be located away from the main street unless they can be designed to accommodate 'active' ground floor uses. Consideration needs to be given to the design of the building's façade so this has a minimal effect on the centre's streetscape.
- v. Parking and circulation areas adjacent to the open space network need to be carefully designed and landscaped to integrate with the streetscape, landscape and buildings.

3. Passenger Transport

Within the Town Centre, it is intended that bus stops will be integrated into the carriageway of the transport corridors. A transport interchange will be provided and located opposite the public square on either side of the Main Street. A number of routes will converge on the centre at this point enabling people to transfer from one route to another.

The interchange (including shelters, bins and other streetscape elements) needs to be carefully designed to reflect and compliment street character, the public square, and surrounding buildings. The street at this location needs to be designed as a 'shared space' (where no single mode has priority) to facilitate the large number of pedestrians anticipated to be crossing the transport corridor at this point.

4. Gateway design principles

Two gateways have been identified on the concept plan, to define the start and end of the heart of the Rototuna centre. Main road intersections provide opportunities for landmark buildings/structures which are often used to announce the sense of arrival and departure.

It is therefore important that the gateway features be carefully designed so that views can terminate upon them. The exact form of the Gateway features has yet to be determined and will be developed as part of the CDP for the area. Council's Public Art Plan will be a key reference point.

1.4.5 Key Development Site Design Guidance

1.4.5.1 Purpose

These design guidelines apply to new buildings, including, where appropriate, alterations and additions to existing buildings on Key Development Sites identified in Volume 2, Appendix 5, Figure 5-9.

The intention of the guidelines is to provide landowners, applicants, Council regulatory staff and decision makers with an indication of desired outcomes for the sites based on the objectives and policies of the Central City area. Key design principles have been provided for each site to promote and encourage good urban design outcomes. The priority outcomes, concept plans, sections and precedent images are indicative only, and represent one way in which the key design principles for development may be applied.

1.4.5.2 How to use the Design Guide

Applications for new buildings, including, where appropriate, alterations and additions to existing buildings on Key Development Sites identified in Volume 2, Appendix 5, Figure 5-9 shall provide an assessment of how the proposed design will promote the key design principles and, in doing so, achieve the objectives and policies of the Central City area.

1.4.5.3 Key Development Site 1 – Cobham Drive

Located in the City Living Precinct, bounded by Clarence and Anglesea Streets and Cobham Drive (refer to Figure 1.4.5a).

- a) **Site Characteristics**
 - i. Flat, Central City-edge fringe, 2991m².
 - ii. The site occupies a prominent corner location at the southern entry to the Central City with potential to create a memorable corner reinforced by the design of the building.
 - iii. The site is currently under-utilised accommodating a 730m² building with the remaining site occupied by grade car parking (refer to Figure 1.4.5b).
 - iv. The site has a north-facing frontage, which faces onto a no-exit street (which has potential to be upgraded to enhance local amenity).
 - v. The potential for the site to be a pedestrian destination from the Central City is limited, however, there is potential for the site to be an anchor to activities in the existing blocks to the north.
 - vi. There is the potential to improve site access from Clarence Street, improving access to the arterial transport network.

b) Key Design Principles

- i. Maximise the development potential of the site.
- ii. Provide for a diverse range of activities, including appropriate ground floor activities that address Clarence Street (e.g. small format retail, dining).
- iii. High-quality living environment shall be encouraged through appropriately sized and located internal living spaces with adequate external outlook space, orientated to maximise solar gain.
- iv. Locate internal shared open space adjacent to Clarence Street and design this as a destination. Council has the potential to provide for 90 degree parking along Clarence Street, adjacent to street facing and courtyard dining.
- v. Provide for retail, commercial office and other uses that add to the vitality of the City Centre.
- vi. Provide for car parking away from the street (e.g. internal, above ground or below ground).

c) Short term priority outcomes

- i. Landowners / applicants to develop a site masterplan to review the bulk and location options, and assess the usability of landscape strips currently edging arterial transport corridors.
- ii. Develop the site to establish an attractive built form entry to Hamilton's Central City.
- iii. Subject to funding, Council to upgrade the street amenity (paving, trees, carparking) at the same time as building development occurs.

Note

Landowners/applicants of the key development site and Council are encouraged to liaise together, to work towards a common vision for the key development site (led by the landowner/applicants) and the adjoining public realm (along Clarence Street, led by Council), to achieve the Key Design Principles outlined above.

d) Medium to long term priority outcomes

- i. Build on the precedent set by the primary redevelopment and encourage the revitalisation of Clarence Street.

e) Proposed mix of uses on site

- i. Net retail and commercial approximately 5,600m² (approximately 225 employees/235 employees per hectare).
- ii. Net residential: approx. 36 1-3 bedroom residential units; approx. 90-100 residents (approximately 100 dwellings per hectare).

- f) Figures 1.4.5c to 1.4.5i show indicative concepts and future development preferences that are consistent with the design principles for this site.

Figure 1.4.5a: Location map of Key Development Site 1



Figure 1.4.5b: Existing situation on Key Development Site 1 (2014)



Figure 1.4.5c Indicative concept plan for Key Development Site 1 – long term vision



Figure 1.4.5d: Indicative concept cross section A-A for Key Development Site 1

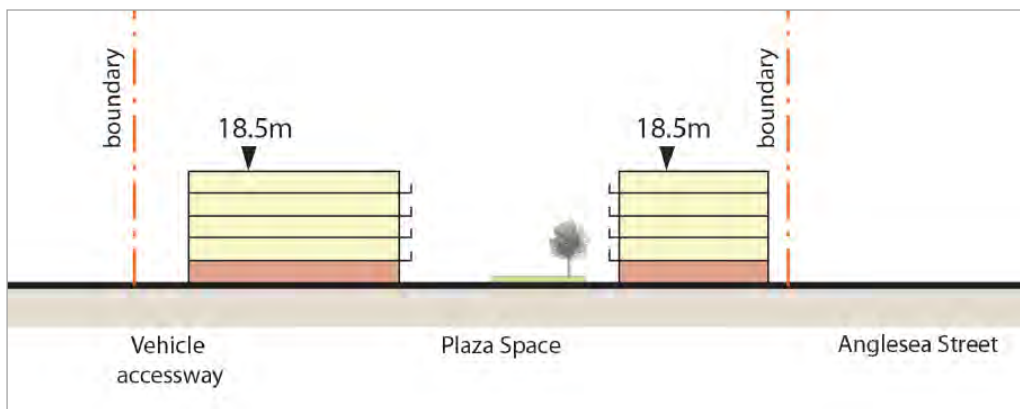

Figure 1.4.5e: Indicative concept cross section B-B for Key Development Site 1

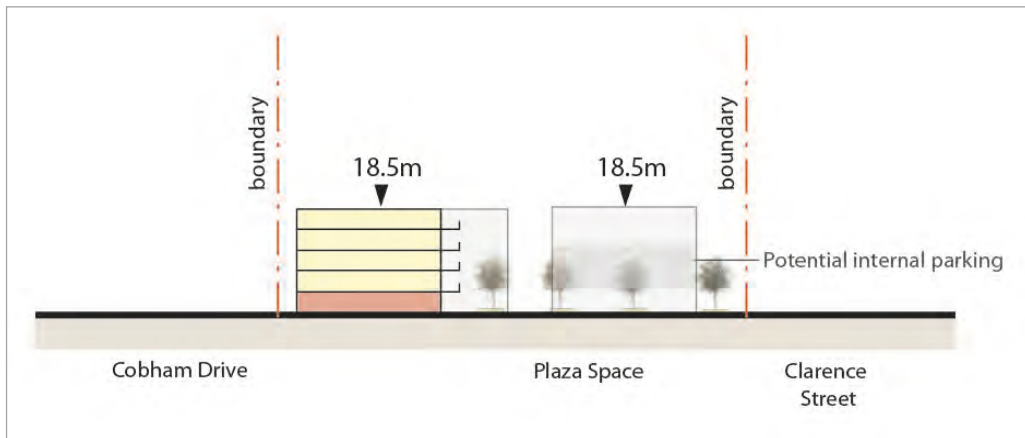

Figure 1.4.5f: Future development preference – indicative visualisation of potential future development showing active ground level, courtyards, streetscape improvements and five to six storey development emphasizing the gateway location



Figure 1.4.5g: Future development preference – architecture that responds to the site and its gateway location



Figure 1.4.5h: Future development preference – five storey commercial/mixed use with activate frontages along Clarence Street



Figure 1.4.5i: Future development preference – plaza space within the site



1.4.5.4 Key Development Site 2 – Corner of Alexandra and Hood Streets

Located in the Downtown Precinct, bounded by Alexandra, Hood and Anglesea Streets (refer to Figure 1.4.5j).

a) Site Characteristics

- i. Flat, Central City site, 10,300m².
- ii. Large block pattern.
- iii. Currently dominated by car and service yards, and low density commercial uses (refer to Figure 1.4.5k).
- iv. Located adjacent to an existing car parking building in close vicinity to Garden place and Victoria Street.

b) Key Design Principles

- i. Maximise commercial development potential of the site, providing high quality offices with shared open space.
- ii. Provide active frontages at ground level through appropriate commercial retail activities; increase public realm by requiring a 2m setback on Anglesea Street.
- iii. Provide ongoing opportunity for existing uses including car sales, albeit in a higher amenity environment.
- iv. Provide for through site links to assist in breaking up blocks, building upon wider proposals for future pedestrian connections.
- v. Provide for underground parking where required.

c) Short term priority outcomes

- i. Upgrade of Alexandra and western Hood Streets.

d) Medium to long term priority outcomes

- i. Comprehensive development of sites, including provision of shared private public space and a pedestrian through link at mid block, between Anglesea and Alexandra Streets.

e) Proposed mix of uses on site

- i. Net retail and commercial approx. 21,800m² (approximately 870 employees).
- ii. No residential component is envisaged.

Figures 1.4.5l to 1.4.5r show indicative concepts and future development preferences that are consistent with the design principles for this site.

Figure 1.4.5j: Location map of Key Development Site 2



Figure 1.4.5k: Existing situation on Key Development Site 2 (2011)



Figure 1.4.5l: Indicative concept plan for Key Development Site 2 – long term vision

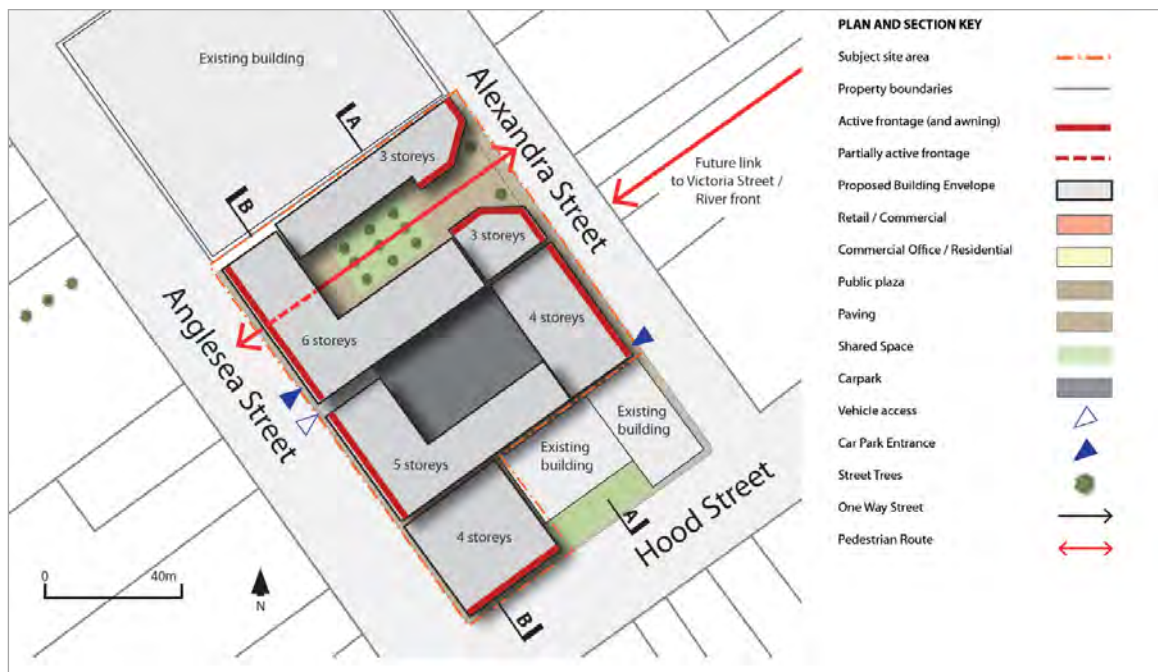

Figure 1.4.5m: Indicative concept cross section A-A for Key Development Site 1

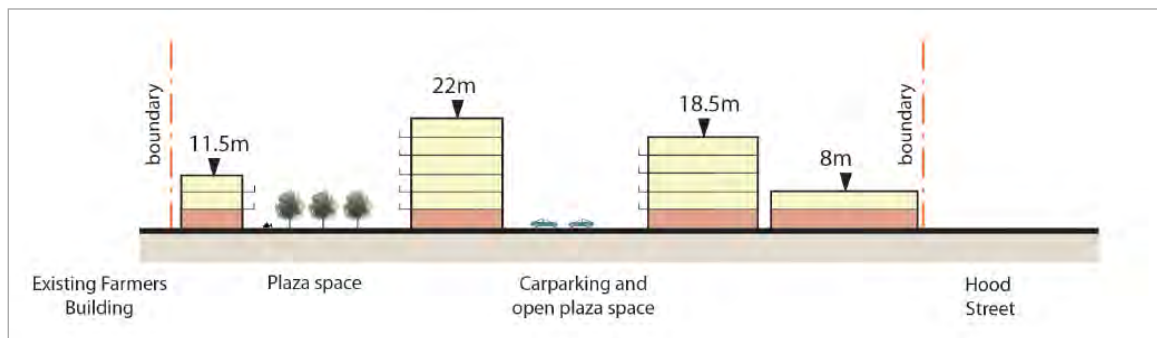

Figure 1.4.5n: Indicative concept cross section B-B for Key Development Site 1

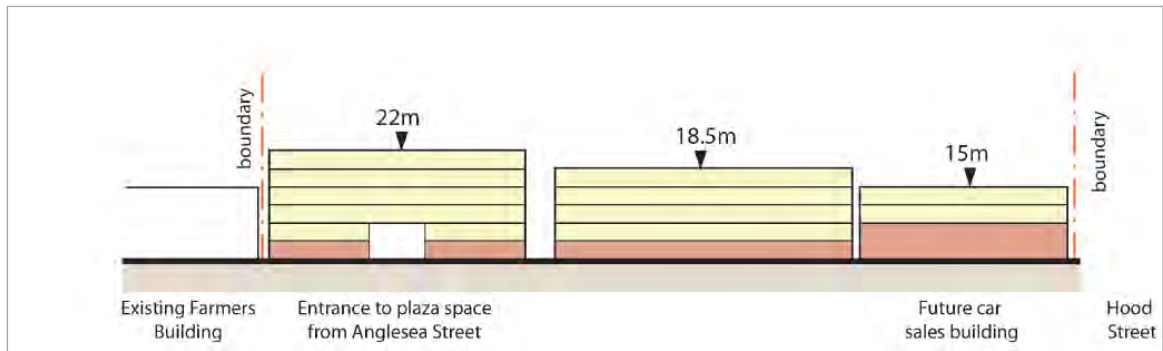

Figure 1.4.5o: Future development preference – Indicative visualisation of potential future development showing through-site links, active ground floor uses, improved streetscape, increased landscape amenity and high quality built form



Figure 1.4.5p: Future development preference – high quality, car showroom with offices above



Figure 1.4.5q: Future development preference – 3D model showing potential built form, with through-site links, internal courtyards and veranda cover



Figure 1.4.5r: Future development preference – internal public courtyard



1.4.5.5 Key Development Site 3 – Victoria on the River

Located in the Downtown Precinct, on Victoria Street (refer to Figure 1.4.5s).

a) Site Characteristics

- i. Flat, riverside site, approximately 3,800 m².
- ii. Located on Victoria Street, within the restaurant and cafe hub of the city
- iii. Located adjacent to and with good views over the river; currently underutilised (predominantly parking) in relation to its strategic position within the city (refer to Figures 1.4.5t and 1.4.5u).
- iv. Potential to contribute to the revitalisation of the city centre and, in particular, enhance the relationship with the Waikato River.

b) Key Design Principles and Priority Outcomes

- i. Maximise development potential of the site: provide for restaurant, cafe, small scale offices and similar uses at ground level, and for commercial and residential living at upper levels.
- ii. Provide for a Riverfront promenade as outlined below in the indicative concept plan Figure 1.4.5v and in Figure 1.4.6b: Future Vision (2021).
- iii. Provide north-south pedestrian access along the river's edge (through building setbacks), implemented over time with adjoining sites.
- iv. Respect the existing built form pattern along Victoria Street through appropriate scale.
- v. Residential and commercial units to have access to high amenity outdoor space.
- vi. Provide access from Victoria Street through to public open space, adjacent to the river's edge.

vii. Provide for vehicle parking away from Victoria Street preferably underground, undercroft (sleeved) or at upper levels (subject to viability).

c) Short term priority outcomes

i. Masterplanning and redevelopment of site as a comprehensive development; access to public open space adjacent to rivers edge.

d) Medium to long term priority outcomes

i. Provision of access to lower river walkway, continued access along adjacent sites.

ii. Access to construction of, a pedestrian bridge across the river.

e) Proposed mix of uses on site

i. The site has the possibility to provide for up to approximately 10,000m² of gross floor space.

ii. Land use at ground level should be limited to retail and small scale office activities.

iii. Land use at upper levels may be commercial and/or residential.

Figures 1.4.5v to 1.4.5cc show indicative concepts and future development preferences that are consistent with the design principles for this site.

Figure 1.4.5s: Location map of Key Development Site 3



Figure 1.4.5t: Existing situation on Key Development Site 3 (2011)



Figure 1.4.5u: Existing situation on Key Development Site 3 (2011)



Figure 1.4.5v: Indicative concept plan for Key Development Site 3 – long term vision



Figure 1.4.5w: Indicative concept cross section A-A for Key Development Site 3

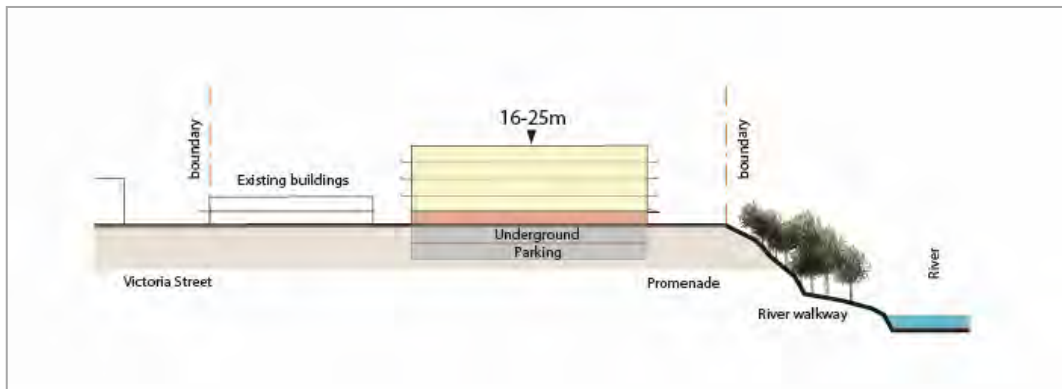

Figure 1.4.5x: Indicative concept cross section B-B for Key Development Site 3

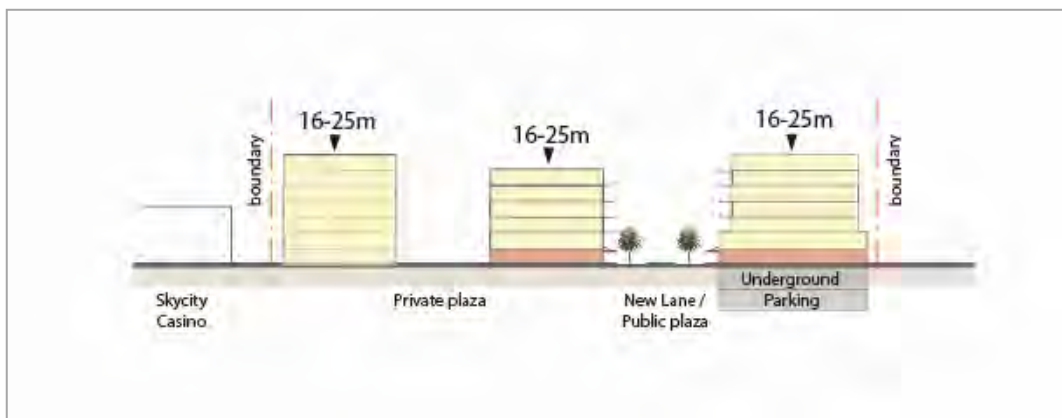

Figure 1.4.5y: Future development preference – upper level riverfront promenade and recreation space



Figure 1.4.5z: Future development preference – internal laneway/shared lane with active frontages



Figure 1.4.5aa: Future development preference – courtyard dining along an internal laneway with active frontages



Figure 1.4.5bb: Future development preference – Indicative visualisation of potential development showing a high quality through-site link connecting Victoria Street with the riverfront, active ground floor frontages, veranda cover and landscaping



Figure 1.4.5cc: Future development preference – indicative visualisation of future promenade along Victoria on the River, with access down to the river walkway and to a future river crossing



1.4.5.6 Key Development Site 4 – Warehouse/Kmart/Transport Centre Site

Located in the Downtown Precinct, bounded by Anglesea, Ward and Tristram Streets (refer to Figure 1.4.5dd).

a) Site Characteristics

- i. Flat Central City site, 46,160m².
- ii. Currently dominated by low density, large format, commercial use with little or no relationship to the surrounding public realm (refer to Figures 1.4.5ee and 1.4.5ff).

b) Key Design Principles

- i. Maximise development potential of the site, providing flexibility and ensuring a high quality public realm is delivered, particularly along Ward and Bryce Streets.

Practice Note: Make full use of development potential, include a mix of uses and focus on the contribution of the building to the public realm.

- ii. Provide frontages which promote activity and passive surveillance to provide for good pedestrian amenity on high pedestrian routes.

Practice Note: Provide active frontages to Key Development Site 4 where:

1. The buildings with public road frontage and frontage onto a through site link shall:

- *Provide at least 75% of the primary active frontage, and at least 50% of the secondary active frontage or through site link, as clear glazing (or equivalent) at ground floor level.*
 - *Be capable of use for displaying goods and services to passing pedestrians.*
 - *Not have painted, covered or otherwise altered glazed areas so as to render them ineffective in achieving the purpose of this rule.*
2. *Vehicular access across active frontages shall not use any more than 10% of the defined frontage.*
 3. *The principle public entrance to a building shall be provided from the active frontage.*
 4. *All storage areas should be situated within or to the rear of the buildings.*

- iii. Provide for a north-south pedestrian through site link between Bryce Street and Ward Street through Key Development Site 4.

Practice Note: Enable a legible pedestrian connection and through site link that responds to or enhances pedestrian permeability, between street Ward Street and Bryce Street, taking into consideration the Transport Centre, traffic movements and potential pedestrian crossing points along those streets.

- iv. Enhance crossing points between north and south blocks over Bryce Street while enabling traffic flows and access to parking along Bryce Street.
- v. Provide appropriate built form to create a gateway to the Downtown Precinct.

Practice Note: The built form on the corner of Tristram and Ward Streets should reinforce the gateway function through appropriate height, architectural form and detailing.

- vi. Protect the public transport function of the Transport Centre.

Practice Note: Maintain vehicle access points for the safe and efficient movement of the public transport vehicles to and from the transport centre.

c) Short term priority outcomes

- i. Upgrade of Anglesea and Ward Streets.

d) Medium to long term priority outcomes

- i. Comprehensive development of sites, to deliver a gateway building and attractive, safe streets and pedestrian spaces (including through site connectivity) which connect to the wider movement network.

e) Proposed mix of uses on site

- i. A wide range of activities are appropriate for the site including retail, commercial office, cafes and restaurants, education, car parking buildings, residential apartments and other uses that add to the vitality of the city centre.

Figure 1.4.5dd: Location map of Key Development Site 4



Figure 1.4.5ee: Existing situation on Key Development Site 4 (2011)



Figure 1.4.5ff: Existing situation on Key Development Site 4 (2011)



Figures 1.4.5gg to 1.4.5kk show indicative concepts and future development preferences that are consistent with the design principles for this site.

Figure 1.4.5gg: Indicative concept plan for Key Development Site 4 – long term vision



Figure 1.4.5hh : Future development preference – indicative visualisation of potential development showing an improved streetscape with increased pedestrian priority, active ground floor uses, enhanced landscaping and high quality built form contributing to a 'human scale' along the street.



Figure 1.4.5ii : Future development preference – activated through site link, human scale development



Figure 1.4.5jj : Future development preference – high quality built form, improved streetscape and landscaping



Figure 1.4.5kk : Future development preference – local dining along street edge/laneway



1.4.5.7 Key Development Site 5 – Countdown Site, Anglesea North

Located in City Living Precinct, bounded by Anglesea, Vialou and Liverpool Streets (refer to Figure 1.4.5ll).

a) Site Characteristics

- i. Flat Central City fringe site, 15,600m².
- ii. Site is occupied by large format food retail with a service station on the corner (refer to Figure 1.4.5mm)
- iii. Located on a prominent entry corner and potential future gateway to Hamilton's Central City.
- iv. Site design and surrounding street radii based on vehicle access.
- v. One block away from significant open space (west of Tristram Street).
- vi. Building is set back from the street with carparking in front.

b) Key Design Principles

- i. Continue to support the existing supermarket activities on site, as a building block for future high density residential living within the northern city area.

Practice Note: Supermarket activities have the potential to support future residential development on and around the subject site and are therefore encouraged (although not essential), either in their current form, or within an alternative more compact form in the future.

- ii. Provide for high amenity pedestrian routes around and through the site.

Practice Note: Where practicable, pedestrian routes through the site be provided to increase permeability. These routes should be free of conflict with vehicles, have good CPTED qualities, high landscape amenity, visual interest and be well connected to a wider pedestrian network of desire lines.

- iii. Comprehensive redevelopment of the site should support the gateway function of the site.

Practice Note: The built form of the corner of Anglesea and Liverpool Streets should reinforce the gateway function through appropriate height, architectural form and detailing.

- iv. Provide building frontages which promote activity and passive surveillance to provide for good pedestrian amenity and support the shift to a mixed use area.

Practice Note: Building frontages, particularly at ground level, should provide for interest through the use of architectural features and textures. Passive surveillance of the street should be provided by active uses and glazing at ground level, pedestrian entry and exit points. Storage and services areas which detract from good building frontage should be placed internal to the site and away from the public street frontage.

c) Short term priority outcomes

- i. Develop a public realm masterplan to establish Council led projects that will reinforce the change in land use and encourage different modes of travel – walking and cycling (refer to Figure 1.4.5nn).

d) Medium to long term priority outcomes

- i. Continue to implement the public realm masterplan that has been developed, including the creation of a northern entry boulevard along Anglesea Street with pedestrian and cycling provision.
- ii. Celebrate and mark the city entrance through development of an appropriate marker building at the corner of Anglesea and Liverpool Streets.

e) Proposed mix of uses on site

- i. Retail, commercial office, education, and other uses that add vitality to the city centre.

Figure 1.4.5ll: Location map of Key Development Site 5



Figure 1.4.5mm: Existing situation on Key Development Site 5 (2014)



Figures 1.4.5nn to 1.4.5uu show indicative concepts and future development preferences that are consistent with the design principles for this site.

Figure 1.4.5nn: Indicative concept plan for Key Development Site 5 – long term vision

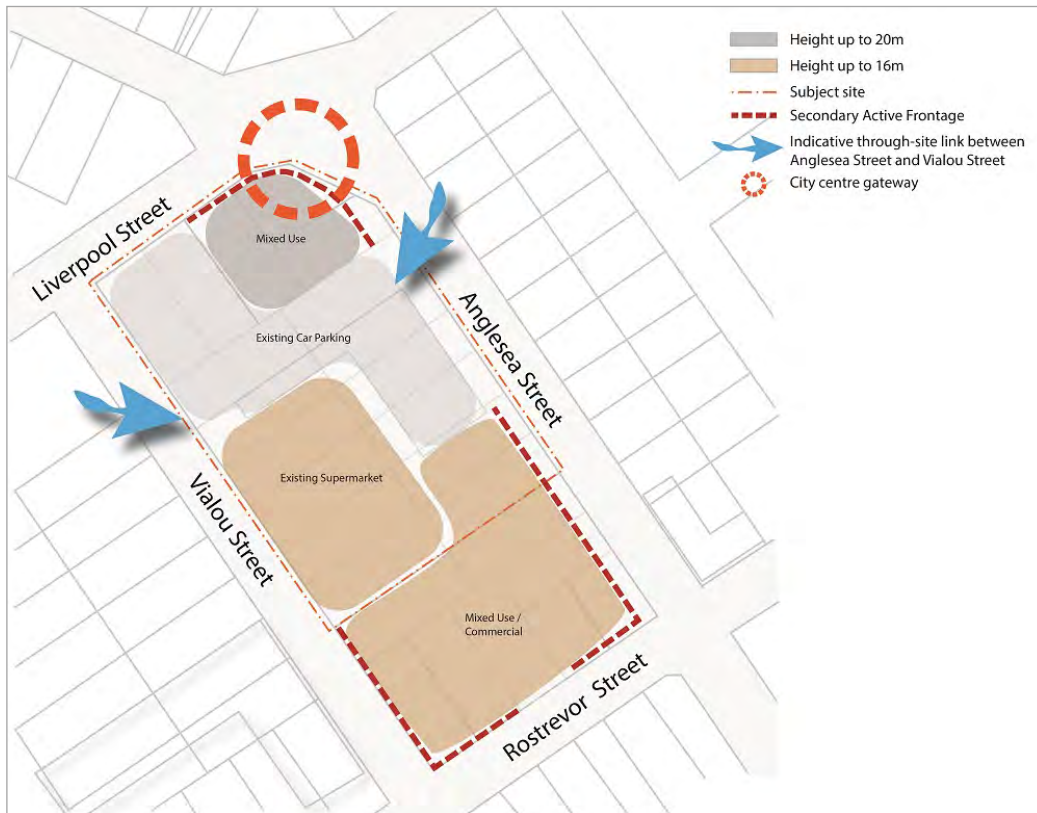

Figure 1.4.5oo: Future development preference – integrated pedestrian and vehicle spaces



Figure 1.4.5pp: Future development preference – integrated pedestrian and vehicle spaces



Figure 1.4.5qq : Future development preference – high quality landscaping within carparks



Figure 1.4.5rr : Future development preference – improved pedestrian space/public realm providing opportunities for passive recreation



Figure 1.4.5ss: Future development preference – Indicative visualisation of potential development showing high quality built form, active frontages and sleeved carparking.



Figure 1.4.5tt: Future development preference – Indicative visualisation of potential development showing a gateway entrance to the Central City from the North, looking down Anglesea Street. High quality built form, improved streetscape and landscaping is promoted at gateway locations



Figure 1.4.5uu: Future development preference – indicative visualisation of potential development including possibility for enhancing connections with surrounding pedestrian and cycle linkage

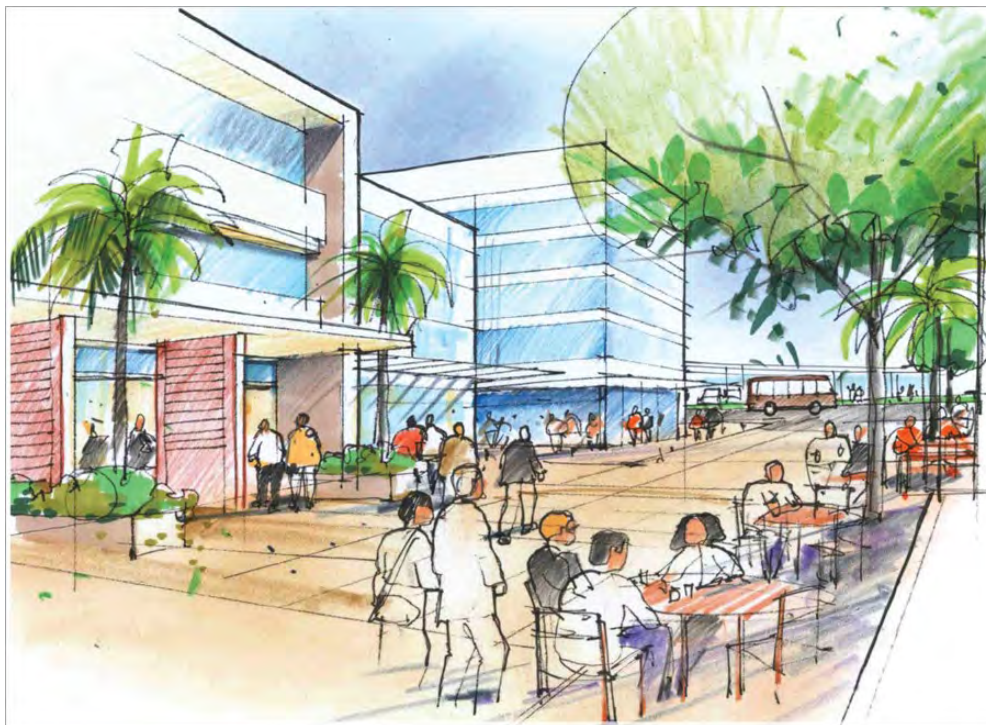

1.4.5.8 Key Development Site 6 – Sonning

Located in the Downtown Precinct on the eastern side of the Waikato River (refer to Figure 1.4.5ww)

a) Site Characteristics

- i. Flat, Central City fringe site, 9,700m².
- ii. Site is used for car parking and Sunday Farmers' Market.
- iii. Located on a prominent entry point to Hamilton's Central City.
- iv. Used as a pedestrian route between the Central City and Claudelands Event Centre.
- v. Western boundary adjoins the Waikato River margins and bank.
- vi. Northern boundary adjoins existing residential development.
- vii. Access off River Road on northern part of the Eastern Boundary. Significant portion of the eastern boundary adjoins the bridge buttressing for River Road crossing the railway line and Claudelands Road.
- viii. Southern boundary adjoins the railway line. A pedestrian footbridge connects Sonning to Claudelands Bridge.

b) Key Design Principles

- i. Development must maintain the amenity of the adjoining residential area to the north.
- ii. Active ground floor use to attract people to visit the site and enhance the viability of development.
- iii. Provide for safe and more clearly defined pedestrian and cycle paths through the site, along desire lines.
- iv. Potential for a sleeved parking building serving the site and providing parking for Central City visitors.

c) Proposed mix of uses on site

- i. Promote a mix of uses such as retail, offices, apartments and/or visitor accommodation.

Figures 1.4.5xx and 1.4.5yy show indicative concepts and future development preferences that are consistent with the design principles for this site.

Figure 1.4.5ww: Location map of Key Development Site 6



Figure 1.4.5xx: Indicative concept plan for Key Development Site 6

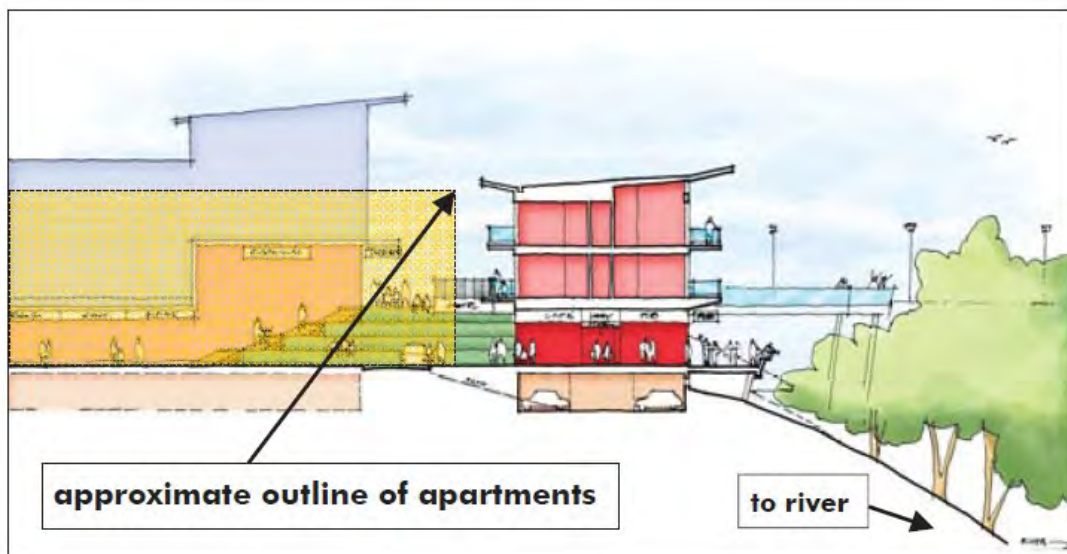
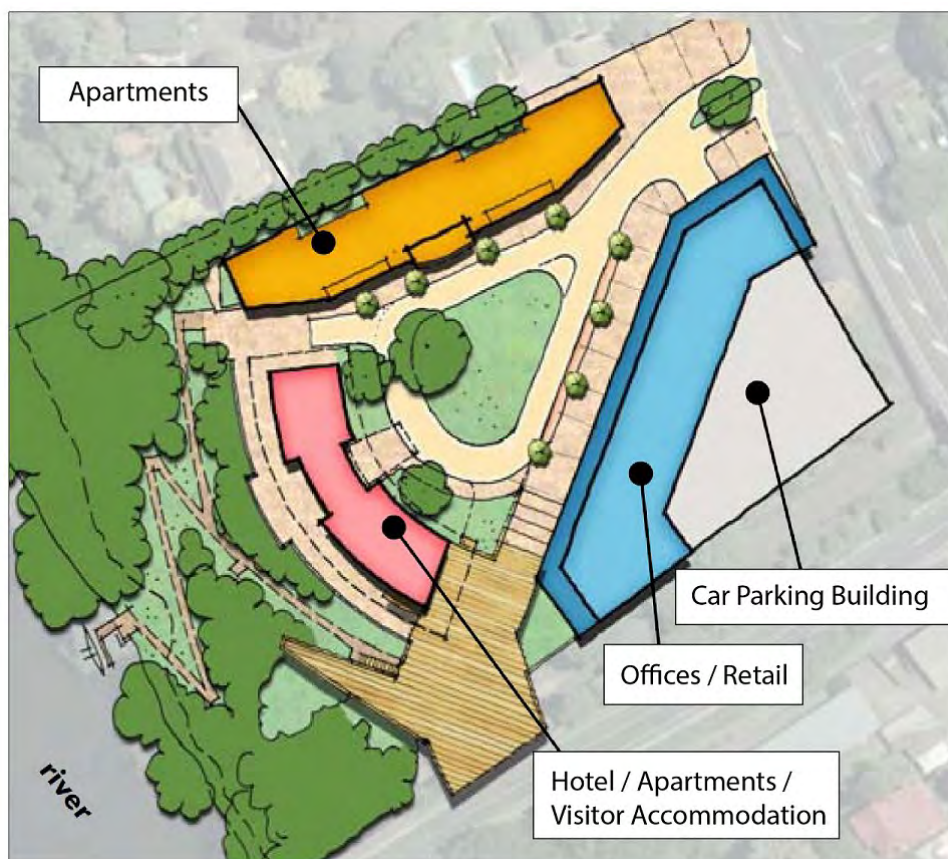

Figure 1.4.5yy: Indicative concept plan for Key Development Site 6

1.4.6 Riverfront Development Design Guide

1.4.6.1 Purpose

These design guidelines are developed to assist groups, landowners, developers, professionals and Council to prepare and assess applications for development within the Riverfront Overlay area as shown in Appendix 5 Figure 5-1.

This design guide applies to development within the Riverfront Overlay area, as shown in Appendix 5 Figure 5-1, and demonstrates how the area can evolve in a way which embraces the Waikato River as part of the Central City.

The existing river frontage in Hamilton is hidden from the Central City. There are a number of obvious connections between Victoria Street and the river's edge and existing built form turns its back on the river. To encourage the establishment of such connections in the public's favour, Council will, in line with the provisions for the Central City, provide incentives through additional height.

This area presents a major opportunity for Hamilton to create a premier public open space along the river's edge, supported by safe and legible connections and attractive and sustainable built form.

1.4.6.2 How to use the Design Guide

Applications for new buildings, including alterations and additions to existing buildings, within the Riverfront Overlay area as shown in Appendix 5 Figure 5-1 should provide an

assessment against the guidance outlined within this Appendix. In particular, it is expected that the proposed design will promote the key design principles, either as shown within the indicative development concepts, or in another manner that achieves a comparable outcome.

1.4.6.3 Background

- a) Figure 1.4.6a illustrates the existing situation along the riverfront in Hamilton's Central City. This shows sparse built form and an abundance of 'dead space' along the river's edge, currently utilised for parking or 'back of house' services.
- b) The existing open space along the river's edge, (Soldiers Memorial Park and Jesmond Park to the East and Grantham Reserve and the area surrounding the Rowing Club to the west) provide green 'book ends' framing the river and providing strong potential for improved connections along the river front itself and across the river from west to east.
- c) There are several 'character' and heritage buildings located along Victoria Street, and these have been highlighted in the plan. It is recommended that heritage buildings be preserved and enhanced with adjacent buildings sympathetic in scale, form and colour.
- d) Building height ranges from 3-4m to 30m along the river's edge, with higher buildings generally used as hotel and accommodation facilities. The form of the buildings ranges from small, narrow shop frontages to large format buildings such as the Casino.
- e) There are several spaces between buildings (refer to Figure 1.4.6a) that could provide successful linkages from Victoria Street to the river's edge.
- f) Activation of these spaces is fundamental to ensuring use and safety. Existing connections to the river are provided down Sapper Moore-Jones Place, the Riff Raff reserve connection and Alma Street.

1.4.6.4 Design Objectives

The following design objectives identify a future vision for Hamilton's Riverfront (refer to Appendix 5 Central City Zone, Figure 5-1 Central City Zone Precinct Plan).

A riverfront promenade will develop over time, with initial public space along the river's edge taking the form of 'pocket parks', as illustrated in Figure 1.4.6b.

Over time, new buildings will set back from the river's edge, and some areas will be built out in front of existing buildings to create a continuous riverside promenade, refer Figure 1.4.6c.

Design Objective	
A Public Riverfront	a) The riverfront will be developed as Hamilton's premiere public space, providing opportunities for people to access and appreciate the Waikato River.
A Connected Riverfront	b) The riverfront will be safely and easily accessible from Victoria Street via streets and laneways. Additional pedestrian connections from the east side of the river will

Design Objective	
	improve pedestrian connectivity not only to the river front, but also to the Central City.
An Active Riverfront	<p>c) The riverfront will be an active public space, with buildings fronting on and opening out on to a riverside promenade.</p> <p>d) This area will be prime real estate, with high quality new development creating complete street blocks between the river and Victoria Street.</p>
A Sustainable Riverfront	e) The riverfront will be sustainable. Built form will carefully consider daylighting principles to ensure that the buildings provide a pleasant environment both within the buildings themselves and also the public spaces which surround them and open out on to the river.
An Iconic Riverfront	f) The riverfront will be iconic – a destination within Hamilton, Waikato and New Zealand. A pedestrian bridge connecting west to east will be a feature, attracting people to the river's edge. The materials, lighting and landscaping along the promenade will be of a high quality, reflecting the significance and beauty of the Waikato River.

1.4.6.5 Design Principles

The following design principles provide guidance as to how the riverfront area should be developed over time to achieve the objectives listed above and the 2021 and 2041 vision (refer to 1.4.6b and 1.4.6c).

These design principles have informed District Plan rules and ensure riverfront development is appropriate and will not degrade or detract from this area of natural amenity.

Design Principles	
Promenade and open space	<p>a) As part of the development or redevelopment of any site adjoining the Waikato Riverbank area between London Street and Sapper Moore-Jones Place, provision shall be made for a continuous pedestrian promenade.</p> <p>b) The minimum width of the promenade is 5m, providing adequate space for pedestrian and cycle access.</p> <p>c) Open space in key locations (i.e. those identified within the medium and long term visions for the Riverfront) shall be provided with minimum dimensions of 15m in width alongside the promenade, to provide room for outdoor dining and other activities. Such space shall be accessible and appropriately designed and landscaped to achieve safe, attractive, comfortable space for use by patrons of restaurants, cafes and the general public.</p> <p>d) All public space, including the promenade, shall be designed in accordance with best practice CPTED principles.</p>

Design Principles	
Height	e) Height allowance will be in relation to provision of public space. Where significant public space is provided (in the form of promenade, public open space or similar, either connecting between Victoria Street and the Riverfront, or along the Riverfront) and gateway locations, additional height shall be provided for. Importantly, height will assist and enable the reading of the cityscape such that taller buildings will be associated with greater public accessibility to the Riverfront.
Built form	<p>f) Building setbacks, in addition to preserving general amenity values, will assist to preserve daylighting, human scale and openness of the proposed promenade (and reduce wind tunnelling effects). Buildings with boundaries adjoining the Riverbank will be required to have a minimum setback of 5m.</p> <p>g) In relation to the setbacks from internal boundaries at upper levels (i.e. fourth level and above), assessment criteria will facilitate a more enabling approach to guide whether the proposal minimises shadowing and loss of natural light on existing adjacent buildings by providing adequate separation between the proposed and existing development.</p> <p>h) Importantly, additional height allowance will be provided for where setbacks from boundaries provide for through-site links and public open space along the riverfront (refer to Figure 1.4.6d).</p> <p>i) Based on the height and built form principles, the preferred built form will be one of narrow buildings running perpendicular to the riverfront, providing for through-site links to the riverfront.</p>

1.4.6.6 Design Interventions

Figures 1.4.6b and 1.4.6c identify six medium-term interventions for key areas or catalyst sites key to realising the design objectives for the Riverfront Area.

Area/Site Reference Refer to Figures 1.4.6b and 1.4.6c	Design Interventions
1	Promote events and temporary activities within this space, drawing people to the river's edge and keeping people engaged through its evolving and temporary nature.
2	Encourage the formalisation of laneways and through-site links into public spaces. Activate laneways through ground-floor activities, such as 'hole-in-the-wall' cafes and encourage upper levels to overlook these spaces to promote safety and CPTED principles.
3	Key Development Site 3 – Victoria on the River (refer to 1.4.5.5).
4	Use streets connecting Victoria Street to the river's edge as key pedestrian links and areas of public space. Open out views to the river at the end of these streets, where possible, and connect the end of the street with the upper-level promenade. Encourage active, ground-floor uses with buildings fronting on to these streets.

Area/Site Reference Refer to Figures 1.4.6b and 1.4.6c	Design Interventions
5	Encourage the development of the 'Art Post' site in line with some of the initiatives outlined as part of the City Heart project, with additional built form complementing the Waikato Museum and better embracing its riverfront location.
6	Encourage the continuation of an upper-level riverside promenade along the western river bank through walkways, built out from the river bank where necessary to connect 'pocket parks' or areas of public space along the riverfront.
7	Provide at least eight pocket parks at regular intervals along the upper level promenade, terminating at major through-links, to act as activity nodes along the promenade that will support and encourage walking and enjoyment of the river environment.

Figure 1.4.6a: Existing Situation (2011) – An analysis of the existing riverfront, illustrating areas of vacant or underutilised space, age of buildings and potential connections

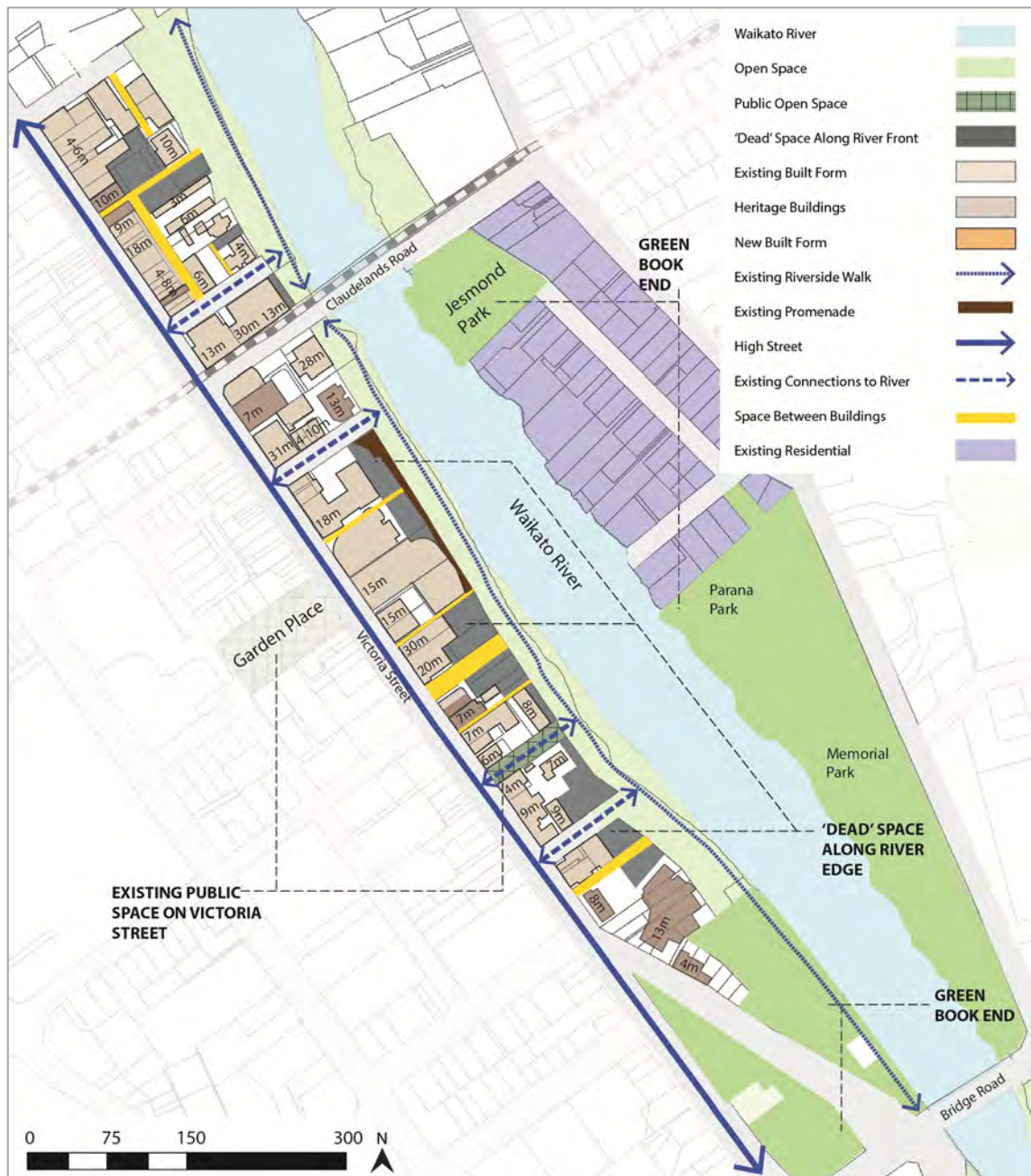

Figure 1.4.6b: Future Vision (2021) – Visual representation showing potential development along the riverfront at 2021, beginning with pockets of public spaces

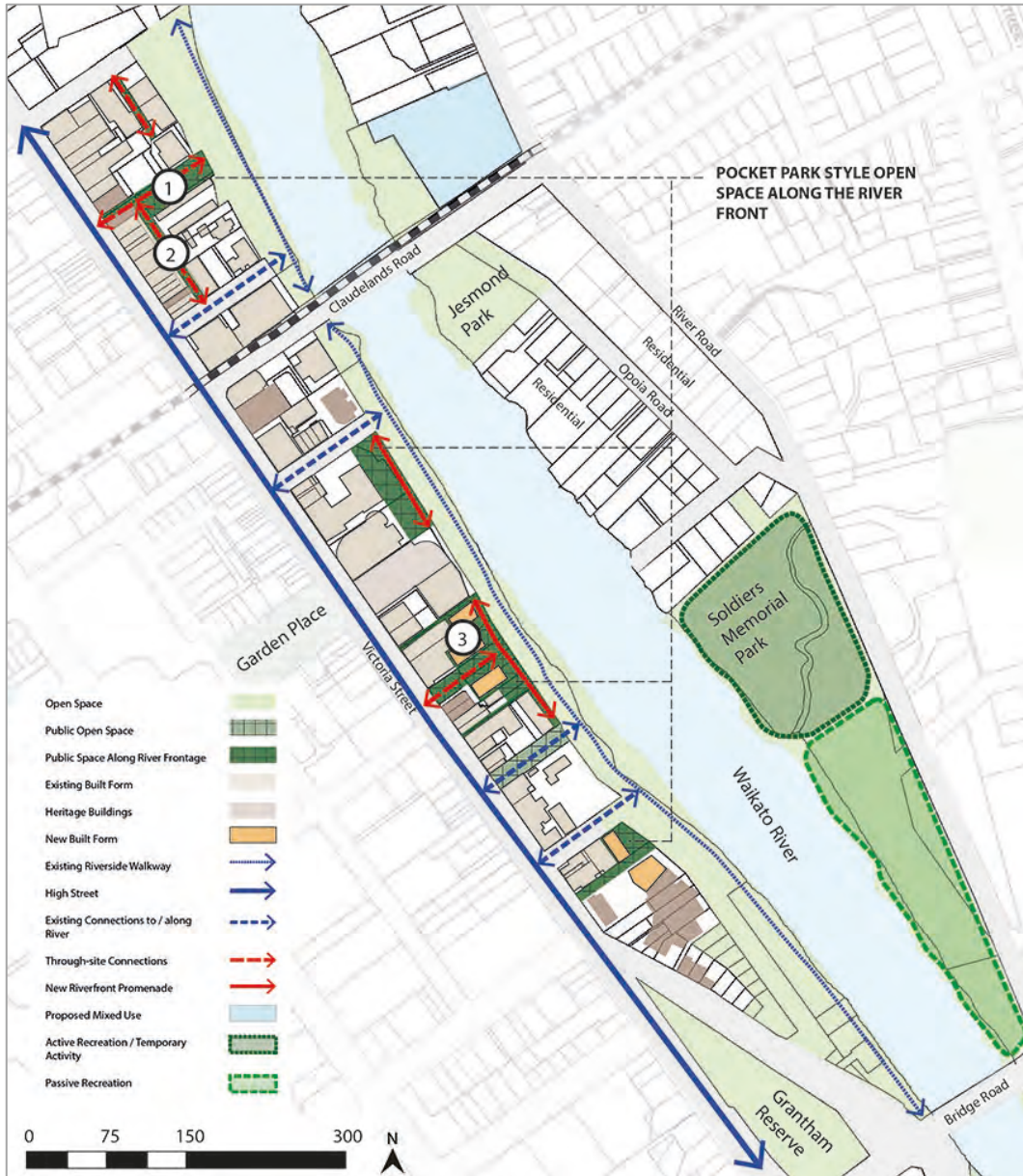

Figure 1.4.6c: Future Vision (2041) – Visual representation showing potential development along the riverfront (including indicative development within Opoia) and a continuous pedestrian promenade

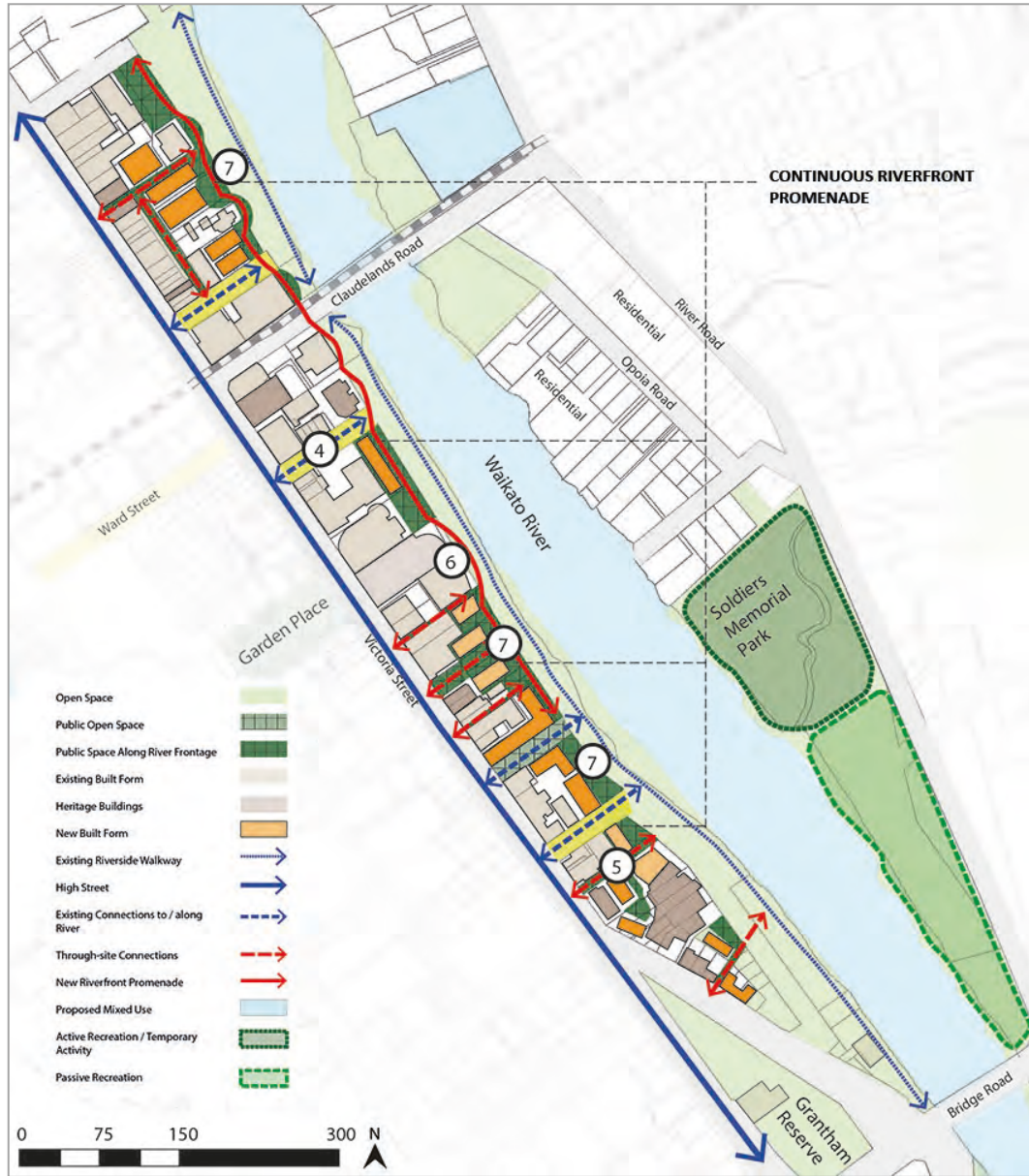
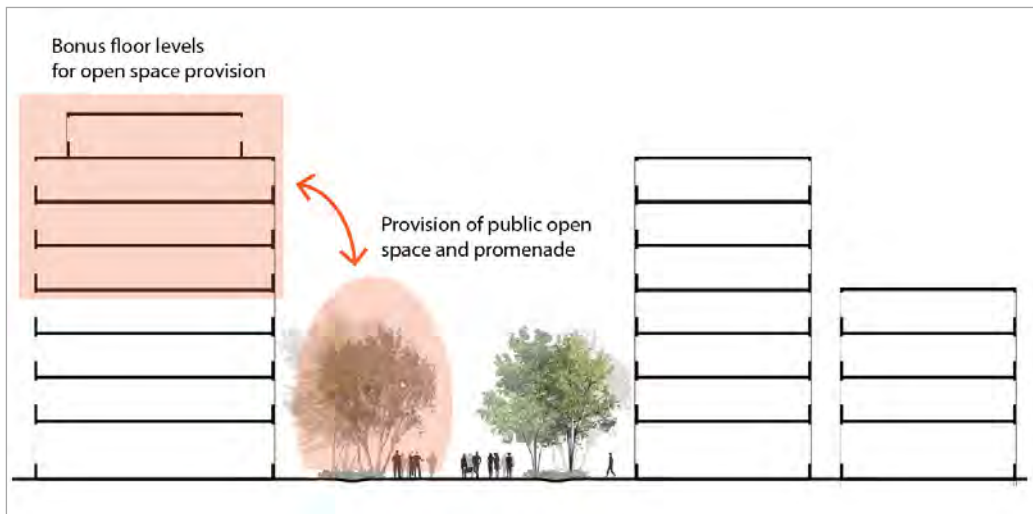

Figure 1.4.6d: Illustrating potential bonus height allowances when through-site linkages and public spaces are provided by development proposals along the riverfront



1.4.7 Lake Waiwhakareke Landscape Character Area Design Guide

1.4.7.1 Purpose

The Rotokauri Structure Plan, the Special Natural Zone and the Rotokauri – Lake Waiwhakareke Landscape Character Area identify the need to protect and enhance the special character of the Lake Waiwhakareke area. The District Plan’s rules regarding development and subdivision provide controls that will enable a sensitive response to this character.

Where these rules provide for an element of discretion through the ability of Council to impose conditions on, this guide provides further description and amplification of the area’s particular character. This will assist with consistent interpretation and provide more certainty to the development industry.

The Guide recognises Council’s commitment to the adaption of best practice urban design techniques as expressed in its urban design guide, *Vista*.

1.4.7.2 How to Use This Guide

Applications for development within the Rotokauri - Lake Waiwhakareke Landscape Character Area as shown on the planning maps provide for an assessment against the guidance outlined within this Appendix.

Within each element, the design guidelines are organised as follows.

Explanation

Rationale for that particular design element and how it contributes to the development of a sustainable neighbourhood.

Design consideration

Consideration to guide development outlining how a proposal should respond to particular elements of character.

Design guideline

Representative of good design solutions which help achieve the design consideration. They do not however preclude other ways of achieving good design.

1.4.7.3 Background

The Lake Waiwhakareke Landscape Character Area represents a distinctive landscape unit which is defined by Rotokauri Road to the east and north, Brymer Road to the west and Baverstock Road to the south. The characteristics of the Lake Waiwhakareke Landscape Character Area are described in the operative Waiwhakareke Natural Heritage Park Management Plan 2011 and summarised in this guide. This character is derived from the unique combination of natural, cultural and recreational values present in and around the lake and the Natural Heritage Park. Together the lake and Natural Heritage Park create a focal point for adjoining development and provide very significant and cultural opportunities that need to be recognised and reflected through future development.

The lake and the extensive natural areas provided within the Natural Heritage Park, combined with the sharply undulating topography that frame them, clearly sets this part of the Rotokauri Structure Plan area apart from the area to the north of Rotokauri Road.

The following character elements have influenced how the Rotokauri Structure Plan and Special Natural Zone seeks to manage development in this area.

- The sharply undulating topography of the area and the way in which it provides a point of difference in the landscape
- The native ecology of and the recreational resource presented by the Natural Heritage Park (including its value as an educational resource)
- The lake itself and its role in providing a strong focal point for the area
- The natural drainage pattern of the area
- The historic and cultural values associated with the area.

1.4.7.4 Understanding the Context

a) Explanation

The Lake Waiwhakareke Landscape Character Area is located at the southern end of the Rotokauri Structure Plan, in close proximity to existing urban development along Baverstock Road and to a lesser extent along Rotokauri Road. It will be dominated by the 50ha Natural Heritage Park that is ultimately intended to become a self-sustaining habitat sanctuary surrounding Lake Waiwhakareke and representative of the original ecosystem diversity of the Hamilton Basin.

The Natural Heritage Park will be managed by the operative Waiwhakareke Natural Heritage Park Management Plan 2011. This provides a framework for the future management of the Park and identifies some key concepts to consider during development of the Lake Waiwhakareke Landscape Character Area. The importance of the location of the entrances to the Park, treatment of the park edges, the planting scheme, the community parks and proposed street furniture design for the residential area are explained within this guide.

The context for development in the surrounding area is established by the Rotokauri Structure Plan. The key locational relationships to note are the presence of Hamilton Zoo adjacent to the southwestern corner of the Heritage Park, the neighbourhood centre proposed to the northeast, the proximity of the Wintec Rotokauri Campus and Nga Taiatea Wharekura School, the green corridor running from Lake Waiwhakareke and the importance of Rotokauri Road as a public transport corridor.

In order to design a development that respects the unique characteristics of a particular location, it is necessary to conduct the following:

- Context analysis
- Site analysis

b) Context analysis – Design consideration

Proposals should demonstrate an understanding of the context of the site, its relationship to the natural and surrounding built environment and the impact that has on the design of the site.

Design guideline

Prepare plans, diagrams and maps that illustrate the location of the site and its characteristics in relation to:

- Proximity to nearby services – shops, transport, schools, other services or recreation facilities
- Immediate surrounds – natural landscape, significant vegetation or waterways, buildings and land uses
- Adjoining infrastructure – roads, open spaces, public transport services

c) Site analysis – Design consideration

Proposals should demonstrate an understanding of the particular features of the site itself, both its natural features and character of the adjacent built up area.

Design guideline

Prepare plans, diagrams and maps that illustrate the characteristics of the site particularly in relation to:

- Natural features – slope, topography, vegetation, waterways, geotechnical considerations
- Orientation – prevailing winds, sun and shading (winter and summer), views, overlooking (to and from neighbours)
- Movement – desire lines, missing links to surrounding neighbourhoods (e.g. from Neighbourhood Centre and Wintec Rotokauri Campus through to Heritage Park and to Hamilton Zoo)
- Other features that may influence site layout – e.g. nearby open spaces, arterial roads

1.4.7.5 Designing for Topography

a) Explanation

The Lake Waiwhakareke area derives a major element of its character from topography. This is sharply undulating in its form with prominent east-west orientated ridgelines that give detail to the area, and provide a point of difference in the landscape.

The ridges and slopes act as local landmarks and enable long distance views to be gained both north to the Hakarimata Ranges and south to Lake Waiwhakareke. Utilising these opportunities will help create a sense of place and a stronger connection to the surrounding landscape.

Retaining the underlying landform is an important part of ensuring that the area's character is preserved once development occurs (refer Figure 1.4.7a). Particular consideration should therefore be given to:

- Designing for slope
- Alternating slope and landform
- Orientation and outlook

b) Designing for slope – Design consideration

Proposals should avoid unnecessary loss of underlying landform, to reflect the character of the site and surroundings and retain the significant features of the site.

Design guideline

- Minimise need for major engineering intervention
- Use existing topography and land features to define the structure of the subdivision – street layouts, open space, view shafts and building platforms (Refer Figures 1.4.7a, 1.4.7b and 1.4.7c)

Figure 1.4.7a: Design with existing features – landform, vegetation, waterways

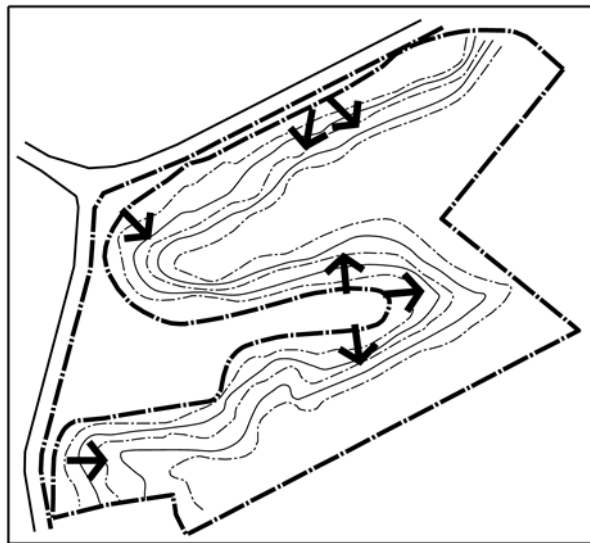
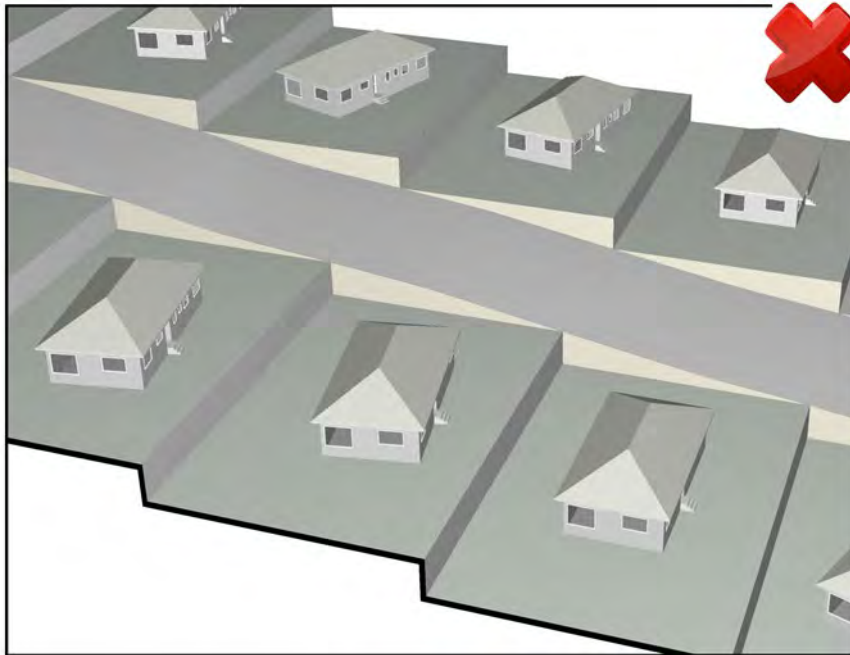

Figure 1.4.7b: Design that has worked with existing features – landform, vegetation, waterways



Figure 1.4.7c: Design that has not worked with existing features – landform, vegetation, waterways



c) Altering slope and landform – Design consideration

Where it is necessary to re-contour land to allow for access and building platforms, the intervention should not be large scale or visually obvious once planting has matured.

Design guideline

Site contouring and retention should be on a site-by-site basis to allow building platforms to be formed. House designs should be customised to reflect the slope and orientation of the site, discouraging single platform for each site on sloping terrain.

Use of retaining walls should be minimised by terracing and planting to mimic the natural features, particularly when viewed from the transport corridor.

d) Orientation and outlook – Design consideration

Proposals should take advantage of the sloping terrain to maximise the views available from both individual properties and the public realm (transport corridors and open spaces).

Design guideline

Consider long and short views when aligning transport corridors, open spaces and walkways to provide glimpses of the surrounding landscape and natural features.

1.4.7.6 Reinforcing Local Character

g) Explanation

The Natural Heritage Park will be a defining element of this area's character and surrounding development will establish both a physical and a natural relationship with it.

Residents will have the advantage of a large public space on their doorstep, notwithstanding that access to the Park will be limited and controlled. The Natural Heritage Park will incorporate small community parks at its entrances and these will serve as local purpose reserves.

The way in which landscaping treatments are handled within the developed areas can reinforce the natural settings of the Natural Heritage Park and provide a stronger sense of place and character for the neighbourhoods created around it.

The overall goal for the Natural Heritage Park is to create a self sustaining habitat sanctuary that represents the original ecosystem for this part of Hamilton. The Heritage Park Management Plan identifies the vegetative species appropriate for the differing terrain encountered within the area, such as ridge tops and hill slopes.

Important considerations are therefore:

- Physical and visual relationship to the Natural Heritage Park
- Links to and between existing habitats and features
- Species and planting combinations

b) Physical and visual relationship to Heritage Park – Design consideration

Surrounding development should provide an edge to the Natural Heritage Park, both to increase public surveillance and to offer an opportunity for people to circumnavigate the park and enjoy views into and beyond it.

Design guideline

Buildings along the northern boundary of the Natural Heritage Park should be of sufficient height and orientated towards the park in order to provide surveillance of the road, park or walkway.

Public access should preferably be along a perimeter street, open to cars as well as pedestrians, to provide surveillance from passing traffic and greater safety after dark.

If the site is only appropriate for a pedestrian walkway at the perimeter of the Natural Heritage Park, such as the fence of the hill slope, it should be connected to the street system and of sufficient width to provide long views allowing for curves and changes in topography. This will ensure some surveillance of pedestrians using the walkway.

Fencing adjacent to the walkway should be transparent enough to allow observation from neighbouring houses.

If the topography demands that some lots are side or rear-facing, fencing should be low and transparent and at least one main room should overlook the park edge (refer Figure 1.4.7d).

c) Link to existing habitats – Design consideration

Public and private spaces within the Lake Waiwhakareke Landscape Character Area should reflect ecosystems within the Natural Heritage Park and provide an extension of the parks habitat. This will create a network of indigenous flora and fauna, and reduce the risk of pest plant invasions of the park.

Design guideline

Identify opportunities to extend habitats which are favourable to flora and fauna beyond the extent of the Natural Heritage Park. While the network does not need to be continuous, it does need to take into account the preferred habitat and travel patterns of the particular species it is intended to encourage.

d) Species and planting combinations – Design consideration

The Natural Heritage Park Management Plan identifies a programme of weeds and predator eradication, and replanting of more appropriate species to encourage indigenous flora and fauna. Identifying and replicating those successful plant combinations both extends heritage plant character beyond its boundaries and creates a low maintenance landscape regime that adds to a sense of place in the surrounding development.

Design guideline

Based on the Heritage Park Management Plan, identify a plant palette and planting scheme which reflects the underlying indigenous combinations and avoids re-infestation of the Heritage Park by weeds. Refer Figure 1.4.7d.

Provide future residents with suggestions for selecting and maintaining planting schemes which extend the philosophy of the Heritage Park.

Any species planted should be eco-sourced.

Refer to *Plant Me Instead: Waikato Region* and *Gully Restoration Guide: A guide to assist in the ecological restoration of Hamilton's gully systems*.

Figure 1.4.7d: Topography and vegetation types at Waiwhakareke Natural Heritage Park

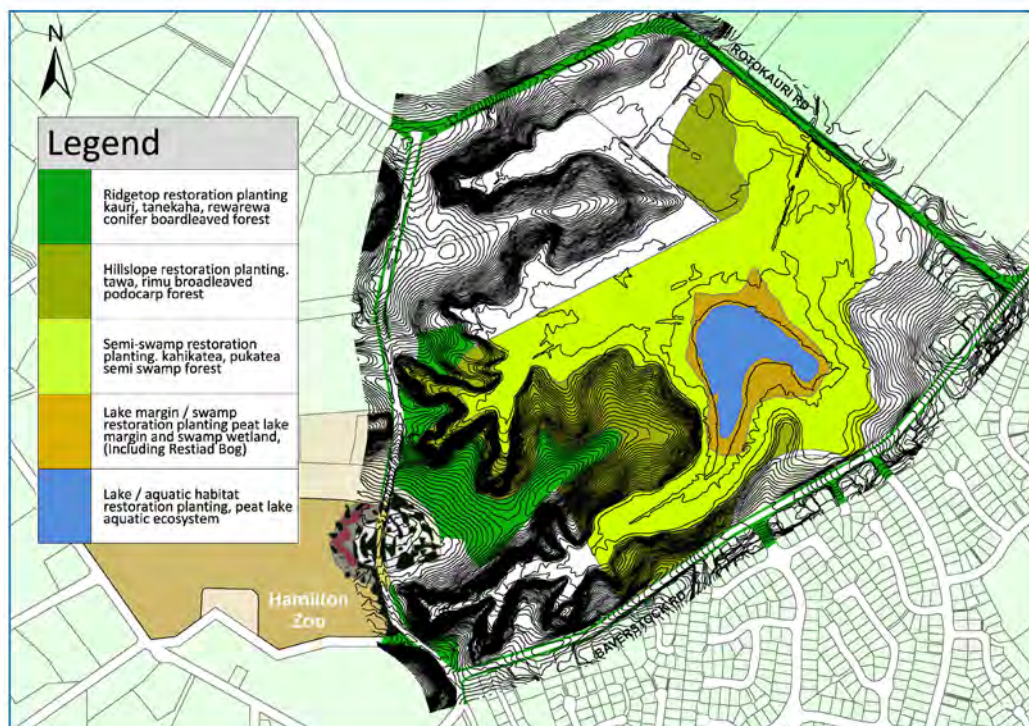

Note

Diagram shows proposed vegetation scheme inside the Natural Heritage Park. This concept should be extended into the surrounding Waiwhakareke Landscape Character Area through the introduction of a range of methods and eco-sourced plants.

1.4.7.7 Connectivity

a) Explanation

Topographical constraints present a number of challenges in terms of achieving high levels of connectivity for movements within and beyond the Lake Waiwhakareke Landscape Character Area. This is true for pedestrian and cyclists as well as motorised vehicles.

The alignment of roads in the area of land immediately north of the Natural Heritage Park is likely to be predominantly east-west in nature. However, in designing a network that encourages walking and cycling it is important to acknowledge that the elements of convenience, safety and amenity required by these users might differ from the needs of those driving cars.

With large parts of the Heritage Park likely to be enclosed by development, it is important that routes into and around the park are legible and provide a choice of routes reflecting desire lines.

Effective connectivity will therefore benefit from a consideration of the following.

- Walking
- Legibility
- Types of streets
- Additional links
- Street Furniture

b) Walking and cycling – Design consideration

Proposals should deliver a connected street network that provides a variety of direct routes for pedestrians and cyclists to nearby services such as the neighbourhood centre, Zoo and the closest entrance to the Natural Heritage Park.

Design guideline

The overall street network should be inter-connected, with block sizes that provide a choice of routes for pedestrians as directly as possible. Where possible, a street used by pedestrians and vehicles is preferable to provide the security of passing vehicles and avoid less used pedestrian-only links.

Given that vehicular traffic flows are expected to be low and slow moving, cyclists should be encouraged to use the street network. Connections to areas outside the Lake Waiwhakareke Landscape Character Area such as the neighbourhood centre may necessitate the provision of dedicated cycle lanes.

Block sizes will vary with topography and location, but ideally should not be longer than 120m between intersections.

c) Legibility – Design consideration

The street hierarchy should be legible for visitors and residents, and clearly signal the route to the park edge or entrances as distinct from more local access to residential blocks.

Design guideline

Identify the main routes to the edges and entrances to the park by the treatment of the street – width, landscape treatment, footpath width and location.

Visual signals, which may match the branding and arts programme proposed for the Waiwhakareke Natural Heritage Park can also act as subtle markers to identify the route to the park, such as colouring of street furniture and lights or distinctive markers along the route (refer Section 1.4.8).

On all streets, cyclists should be encouraged to use the street network. As the routes link to the main external circulation, additional measures such as dedicated cycle lanes may need to be considered.

d) Types of streets – Design consideration

The treatment of each street can vary depending on its location and role. In general it is assumed there will be three main types of streets with section dimensions and treatment to suit.

Local access streets – main circulation connecting sub-neighbourhoods and linking to the Natural Heritage Park.

Green Streets – smaller-scaled street adjacent to the Natural Heritage Park or local reserve.

Local Lane – smaller scaled cross-streets to serve blocks between local access streets.

Design guideline

The Rotokauri Structure Plan provides for low speed, green streets along the northern and south-eastern edges of the Natural Heritage Park in order to provide active frontages.

Minimising curb radii creates tight corners – forcing cars to slow and making it easier for pedestrians to cross.

Avoid roundabouts – these disadvantage pedestrians and cyclists and require more space at intersections (reducing the sense of enclosure and encouraging faster vehicle movement).

e) Additional links – Design consideration

Where streets are not appropriate, allow for safe alternative routes for pedestrians, with good surveillance (refer Figure 1.4.7e).

Design guideline

Pedestrian only routes should generally be not less than 2m wide, provide clear visibility from the main street footpath and contain no hidden spaces which could conceal people or activity from view of the main street.

Pedestrian routes should be overlooked by adjacent development with low or transparent fencing and preferably overlooked by main occupied rooms of the adjacent houses.

If the pedestrian routes are connecting two different levels, attempts should be made to keep the slope at 1:12 and where steps are necessary a handrail should be provided.

The above illustrations indicate an acceptable design for a given environment but should not be regarded as being a specific requirement or the only design solution that will be adopted.

f) Street furniture – Design consideration

Street furniture should cater for the safety and comfort of pedestrians and cyclists, including lighting, street trees and other planting, and items such as seats, rubbish bins and cycle parking racks.

Design guideline

Street lighting should provide high quality, safe environments for pedestrians.

The suite of furniture, including street lights, should co-ordinate with the colours and branding adopted for the Waiwhakareke Natural Heritage Park (refer Section 1.4.8).

Street planting should take into account the need to reflect the native vegetation and planting combinations within the Natural Heritage Park.

Figure 1.4.7e: Layout allows for safe alternative routes for pedestrians, with good surveillance

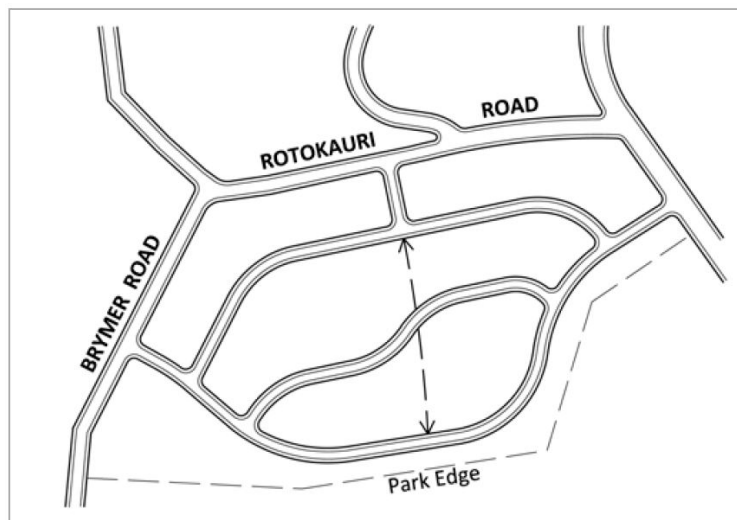

1.4.7.8 The Layout of Development

a) Explanation

The topography of the Lake Waiwhakareke Landscape Character Area presents significant opportunities and constraints for development. The sharply undulating terrain offers the possibility for residents to enjoy long distance views, but at the same time the orientation of the resulting street network may present challenges for maximising solar gain.

On flat land, rectangular or square lots represent the most efficient form of lot layouts. Sloping land however, requires a modified approach to be taken. It is also desirable that the size and shape of lots are configured to allow some flexibility in the types and density of housing that can be established.

The orientation of lots influences the amount of sun gained inside the house and in outdoor living areas. The layout of development should seek to maximise the proportion of dwellings receiving sun, particularly in the winter.

In planning the layout of development, the following issues need to be considered.

- Configuration of lots
- Solar orientation
- Front yard living

b) Configuration – Design consideration

Regardless of the density or housing type being built, the size and configuration of lots should allow for building platforms that provide good internal spaces and solar orientation as well as sunny and private outdoor areas (refer Figures 1.4.7f and 1.4.7g).

Design guideline

- The depth of the lots should allow for an efficient building platform and a distance of 20m back to back between buildings.

Figure 1.4.7f: Design for deeper back yards to allow sun in south-facing parts of the site, front setbacks of at least 3m allow for a front porch or deck

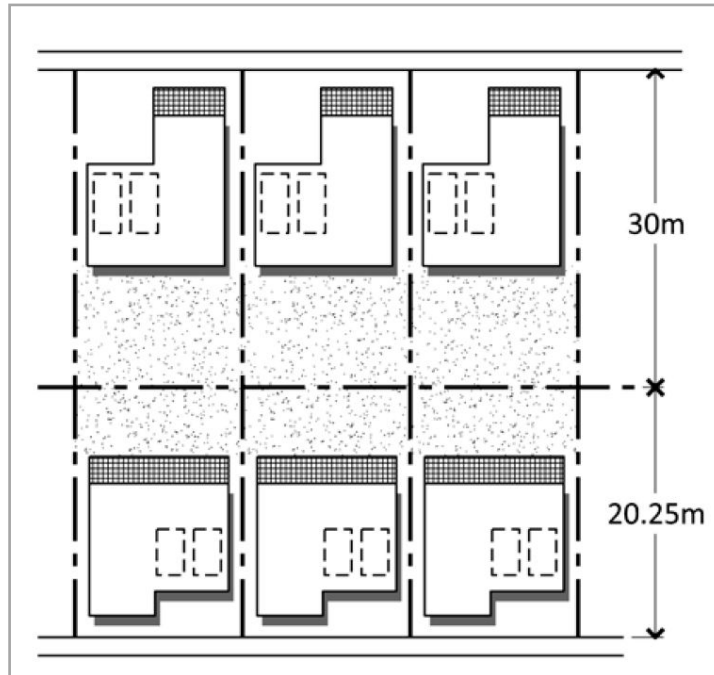
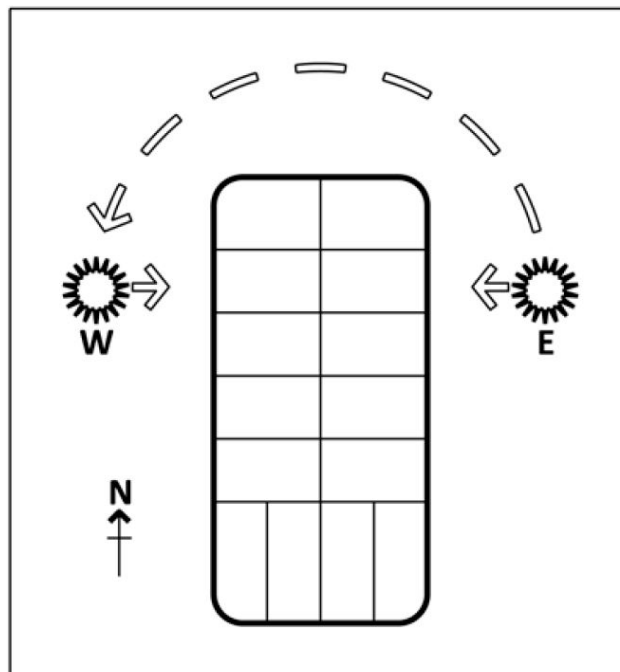

Figure 1.4.7g: Allotments oriented north-south or with north-facing back yards mean sun in front and rear setbacks most of the year



c) Solar orientation – Design consideration

Maximise opportunities for solar gain.

Design guideline

Maximise the number of lots with the long axis within range N200W to N300E or E200N to E300S.

Orientate houses to allow some living spaces setback from the northern boundary to gain northern sun in winter.

In a comprehensive development, zero lot lines can maximise useable outdoor space by setting houses to the southern boundary and locating service areas along that wall.

Vary the depth of north-south facing lots. Consider using the upper levels to create outdoor living platforms that receive some sunshine and may also pick up views over rooftops.

d) Front-yard living – Design consideration

Where the rear of the house may not receive sufficient sunshine, additional outdoor living space should be provided at the front of the house.

Design guideline

Where dwellings have a south-facing back yard, include some form of semi-private outdoor living space on the northern front of the house. Traditional verandas or decks can be treated to provide privacy for those using them but also providing 'eyes on the street' and an attractive frontage for passers-by (refer Figure 1.4.7h).

Upstairs balconies or bay windows also create sunny living spaces and enliven the frontage of a house.

Figure 1.4.7h: Terraces in the front yard allows sunny outdoor living on south-facing slopes

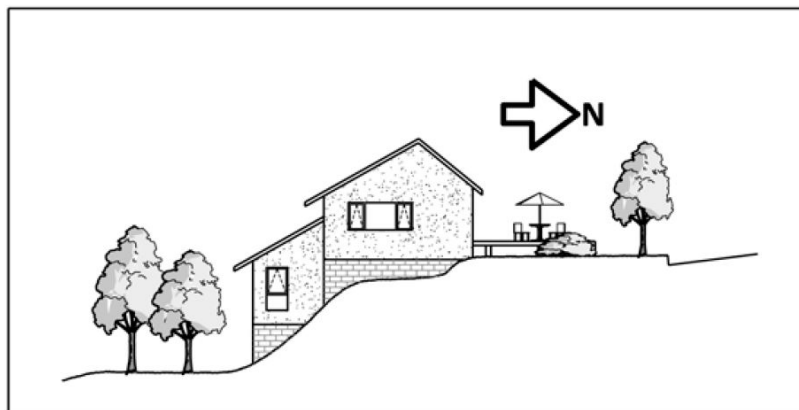

1.4.7.9 Stormwater Management

a) Explanation

Hydrological processes account, in large measure, for many of the natural features present in the Lake area. They are also of special significance for tangata whenua.

Lake Waiwhakareke itself is a sensitive receiving environment and can be adversely affected by both the quality and quantity of stormwater arising from surrounding development.

The management of stormwater must therefore take account of local drainage conditions, which in parts of the area will include peat soils and correspondingly high ground water levels. There are likely, however, to be significant opportunities for incorporating management measures as part of the design of public spaces.

In formulating stormwater management systems, the following matters should be taken into account.

- The potential impact of development on Lake Waiwhakareke
- Retention of natural drainage patterns
- Treatment of streets
- Integration into open space

b) The potential impact of development on Lake Waiwhakareke

Development around Lake Waiwhakareke shall manage the quality and quantity of runoff that enters the Lake in order to avoid any adverse effects on Lake Waiwhakareke.

Design guide

Development should be informed by an approved Integrated Catchment Management Plan. The ICMP should be used to identify any issues that may impact on the water quality of Lake Waiwhakareke.

c) Retention of natural drainage patterns – Design consideration

The natural drainage pattern of the area should be maintained where possible.

Design guideline

Identify natural watercourses in the early site analysis so they can help inform the subdivision layout. Where possible they should be retained and enhanced with vegetation as part of the open space network.

The use of impermeable surfaces should be minimised wherever possible.

Naturally occurring fresh springs should not be piped or diverted.

d) Location and treatment of streets – Design consideration

The street network should take into account overland flow paths and may be designed as temporary flood ways during major storm events. Treatment of berms and kerb systems can absorb some stormwater or minimise flows during extreme events.

Design guideline

Streets adjacent to public open spaces or water courses may be designed as temporary floodways during major events, provided that vehicular access can be maintained (at slow speed) and that water flows do not become a hazard for motorists or adjacent residents.

Swales and rain gardens can be considered, either in the centre of the carriageway or side berms. A 'soft' edge adjacent to a park or open space serves the dual purpose of stormwater management and extending the visual amenity of the park to the edge of the carriageway.

Consider permeable paving on low trafficked streets (such as local lanes) or parking bays which are offset from the main carriageway.

e) Integration into open space network – Design consideration

In addition to creating an open space network around existing water courses or wetlands, permanent water features can be incorporated into open spaces and circulation networks to add amenity or recreational features as well as assist with stormwater or minimise flows during extreme events (refer Figure 1.4.7i).

Design guideline

Incorporate stormwater management into hard and soft landscape design for open spaces and streetscapes. Features such as ponds, wetlands and rain gardens can be considered.

Pedestrian paths between levels can incorporate hard or soft flow paths, creating amenity and stormwater treatment. Care must be taken to ensure paths are still safe and useable during storm events.

Figure 1.4.7i: Pedestrian link on steep slopes provides opportunity for informal watercourse – width provides space for amenity planting as well as surveillance (CPTED)



1.4.8 Design Theme for Waiwhakareke Natural Heritage Park

1.4.8.1 Purpose

The Designation Open Space Zone near Lake Waiwhakareke in the Rotokauri Structure Plan is labelled the Waiwhakareke Natural Heritage Park on the planning maps. This Appendix provides guidance for development within the Park.

1.4.8.2 How to Use This Guide

Applications for development within the Rotokauri - Lake Waiwhakareke Landscape Character Area as shown on the planning maps provide for an assessment against the guidance outlined within this Appendix.

1.4.8.3 Background

Waiwhakareke Natural Heritage Park represents a rare opportunity for Hamilton City to integrate a significant ecological restoration project within its current environmental, promotional, planning and development strategies.

The design intent is to create a key ecological hub within the City. This will not only provide for the well being of the flora and fauna that will live within it, but also for the well being of the City's residents and visitors, through educational opportunities and amenity values it will provide.

Ecological viability and the need to meet the desires and aspirations of the community were key factors in the development of the overview concept for the park. This concept delivers both opportunities for recreation and community wellbeing by creating an accessible natural resource within the City. It also provides for the reintroduction of plants and animals that no longer inhabit the area.

1.4.8.4 Connections

There is an opportunity to create a significant link between the site and Hamilton Zoo. The entrances to the two facilities are located together to create a specific destination. This will allow integration between the facilities and permit efficient use of Council resources through shared use.

Specifically, the creation of a main entrance facility that would combine the entrance facilities of the park and zoo would mean that facilities such as administration, education and retail could be shared between the two amenities.

It is intended that facilities fundamental to the Heritage Park's development and operation are developed on the eastern side of Brymer Rd, and those fundamental to the Zoo's operation, or shared between the Heritage Park and Zoo, developed on the western side.

A number of important secondary nodes and potential access points have also been identified. These are located along Baverstock Road and Rotokauri Roads, indicating potential linkages for the community and Wintec. These nodes are important when considering the location requirements for community parks for Nawton and future communities that will establish as a result of the Rotokauri Structure planning process.

1.4.8.5 Design Overview

The Heritage Park concept involves the retirement and ecological restoration of approximately 50ha of farm land surrounding Waiwhakareke (Horseshoe Lake).

Key components of the concept include:

- a) The creation of an eco-centre, in association with Hamilton Zoo, to act as the main entrance to the park, a tourist destination in its own right.
- b) The reintroduction of indigenous flora and fauna to the site made possible by the use of predator proof fencing to enclose the site.
- c) The development of a publicly accessible walkway network within the site and a cycleway around the perimeter.
- d) While not part of this proposal, two parks will also be created for the local community.

1.4.8.6 Buildings

- a) Buildings will be of contemporary architectural design, reflecting the purpose and function of the park and the zoo.
- b) Buildings will be open to nature, providing opportunities for multi-functional use.
- c) Construction techniques, cladding and roofing materials will follow sustainable design principles, for example cladding buildings in a mixture of natural timbers.
- d) Building design will reflect the ecological themes of the park, yet provide for modern contemporary facilities.
- e) Significant areas of canopy will be incorporated into the building design in order to provide shade and shelter.
- f) A large membrane canopy, covering a paved plaza, will provide a sheltered environment for planting day demonstrations and educational opportunities.
- g) At the main entrance to the park, an integrated facilities building will be constructed.
- h) This will house interpretive material, indoor and outdoor demonstration areas, toilet facilities and provide secure storage for maintenance equipment.
- i) Where possible, sustainable building principles will be used e.g. solar hot water heating, composting toilets.
- j) Building colours should reflect nature and be chosen so that the building blends into its surroundings (e.g. brown tones).

1.4.8.7 Parking

- a) The informal parkland at the main entrance between Brymer Road and the pest-proof fence can be used for overflow parking, and if required may be used for future car park extensions.

1.4.8.8 Main Entranceway

- a) The Zoo and Park will be physically linked by a central pedestrian spine.

- b) Entrance statements and traffic calming measures (decorative rumble strips along Brymer Road) will be used to slow traffic and create a sense of arrival.
- c) Local iwi will be closely involved in the design and development so that recognition of this site and elements of pre-European Māori life are reflected in the park.

1.4.8.9 Furniture and Facilities

- a) It is intended that any constructed elements within Waiwhakareke Natural Heritage Park be elegant and contemporary in nature, reflecting the processes and principles of the ecological design. All furniture should be designed specifically for the park and standard 'off the shelf' street furniture should be avoided.
- b) Facilities and site furniture such as seating, rubbish bins, boardwalks and interpretation panels are to be contextually appropriate. This means that they appear linked to the overall concept of the design when seen within the context of the site. All design should be subtle and symbolic in nature. Literal interpretations should be avoided.
- c) *Seats* – seats will resemble a stylised leaf shape and be constructed out of a renewable hardwood timber or recycled native timber, and a metal frame.
- d) *Rubbish Bins* – rubbish bins will also resemble a stylised leaf shape, constructed out of sheet metal with profile cut and embossed patterns and textures that symbolise the indigenous flora and fauna of the Natural Heritage Park.
- e) *Boardwalk* – the boardwalk network will be made of a renewable hardwood timber and detailed in areas of interpretation with the timber placed in a directional pattern (symbolising the patterns of a leaf).
- f) *Interpretation panels* – the interpretation panels will be constructed of curvilinear sheet metal with profile cut and embossed images and text, and recycled native timber. The timber will incorporate Māori carvings.
- g) *Balustrade (for viewing platforms)* – the balustrades will be constructed with curvilinear sheet metal uprights and steel rods in an overlapping stylised reed pattern.

1.4.9 Temple View Zone Urban Design Guide

1.4.9.1 Purpose of the Guide

The purpose of this guide is to give direction for further development in the Temple View area and assist in understanding the rationale behind the development of the five precincts and how they relate to the valued qualities and character of the Temple View Zone. It highlights urban issues that are specific to the Temple View Zone while assuming that general best practice urban design will be applied for any development. This will assist in ensuring that any development is consistent with the Zone and enhances the wider Temple View community. The District Plan's rules regarding development and subdivision provide controls that will enable a sensitive response to this character.

Where these rules provide for an element of discretion through the ability of Council to impose conditions, this guide provides further description and amplification of the area's particular character. This will assist with consistent interpretation and provide more certainty for future development. This guide responds to the broader scale urban design components of the Temple View Zone.

The Guide recognises Council's commitment to the adoption of best practice urban design techniques as expressed in its urban design guide, Vista.

1.4.9.2 Background

The Temple View area came into Hamilton City Council's jurisdiction in 2004 following a Local Government Boundary Adjustment process. This area consisted of the narrow land connection between the Temple View settlement and Hamilton's boundary at Dinsdale to the east, through to Collins Road to the south where Collins and Tuhikaramea Roads intersect. The majority of the former college campus was brought into Hamilton, with the exception of approximately 14 hectares containing the sports fields, tennis courts and maintenance areas that remained in Waipa District. This was due to mesh block boundaries at that time.

In 2014, following another Local Government Commission process initiated by the Church of Jesus Christ of Latter-day Saints Trust Board and supported by both Hamilton City Council and Waipa District Council, this remaining land area was amalgamated with Hamilton.

The Temple View Zone identifies an area of Temple View which, through a combination of layout, building scale and materiality, colour, landscape treatment and maintenance, has a distinctive character. Much of this character is derived from the cultural influence of the Hamilton New Zealand Temple of the Church of Jesus Christ of Latter-day Saints (the Temple) and the former Associated Church College of New Zealand (CCNZ) Campus, reflecting the combination of planned and opportune incremental development that occurred over the initial construction period throughout the 1950s and 1960s.

This process involved the construction of a range of buildings, some specifically for or in support of the former CCNZ, while others formed part of the construction industry which developed on site during this period. These, often simple structures, provided both masonry product and processed timber to the former CCNZ site and wider afield to support the building of chapels in other parts of New Zealand. Over time, buildings were removed, re-purposed or modified, and others added as required. This resulted in a variety of building styles and forms that reflected the pragmatic and utilitarian requirements of the time. The continued management of the area by the Church, the

application of a limited colour palette and the tended landscape provided a sense of consistency to what would otherwise have appeared markedly disparate elements.

At the closure of the CCNZ in 2009, many of the original structures, while appearing ostensibly sound, were over 50 years old and no longer met contemporary standards for building code compliance or structural integrity. With the closure, an opportunity to repurpose the former campus has provided for a mix of development to support the community. The application of this design guide, in combination with the restricted discretionary consent status for building demolition, will ensure that future development has reference to the original Temple View character.

Figure 1.4.9a: 2012 aerial photo showing the layout of the CCNZ campus prior to the site redevelopment



Figure 1.4.9b: 2012 photograph showing the former CCNZ campus above Tuhikaramea Road and the original teacher housing that lay immediately on either side of Tuhikaramea Road



Figure 1.4.9c: 2012 photograph showing the former CCNZ campus below Tuhikaramea Road and the original teacher housing that lay immediately on either side of Tuhikaramea Road



The Temple View Zone encompasses a broad area that includes the Temple and its immediate environs, the former CCNZ Campus, and the former Teacher Housing that lay on either side of Tuhikaramea Road. This Zone includes 6 heritage scheduled buildings, 3 stands of trees and 1 individual specimen tree that are protected through this Plan. (See Appendix 8 and 9.)

Figure 1.4.9d: 2012 photograph showing the Temple, former CCNZ Campus to the right of Tuhikaramea Road and the original Teacher Housing that lay on either side of Tuhikaramea Road, with residential development to the west.



Figure 1.4.9e: 2012 photograph showing the Temple



The Temple View Zone has been divided into two distinct areas: the Temple View Heritage Area, including the Temple and its immediate surrounds (identified as Precinct 5); and the Temple View Character Area, including the former CCNZ buildings, open space areas, the residential development aligning Tuhikaramea Road and the area south of the Temple (identified as Precincts 1, 2, 3 & 4).

As the Temple View Character Area is more diverse in character and has a greater scope for development opportunities, it has been divided into four areas: Precinct 1 being the elevated land and sports field to the north, Precinct 2 being the flatter land to the south, Precinct 3 being the former sports fields, tennis courts and maintenance sheds, and Precinct 4 to the south of the Temple containing existing living and visitor accommodation.

Figure 1.4.9f: Temple View Precincts

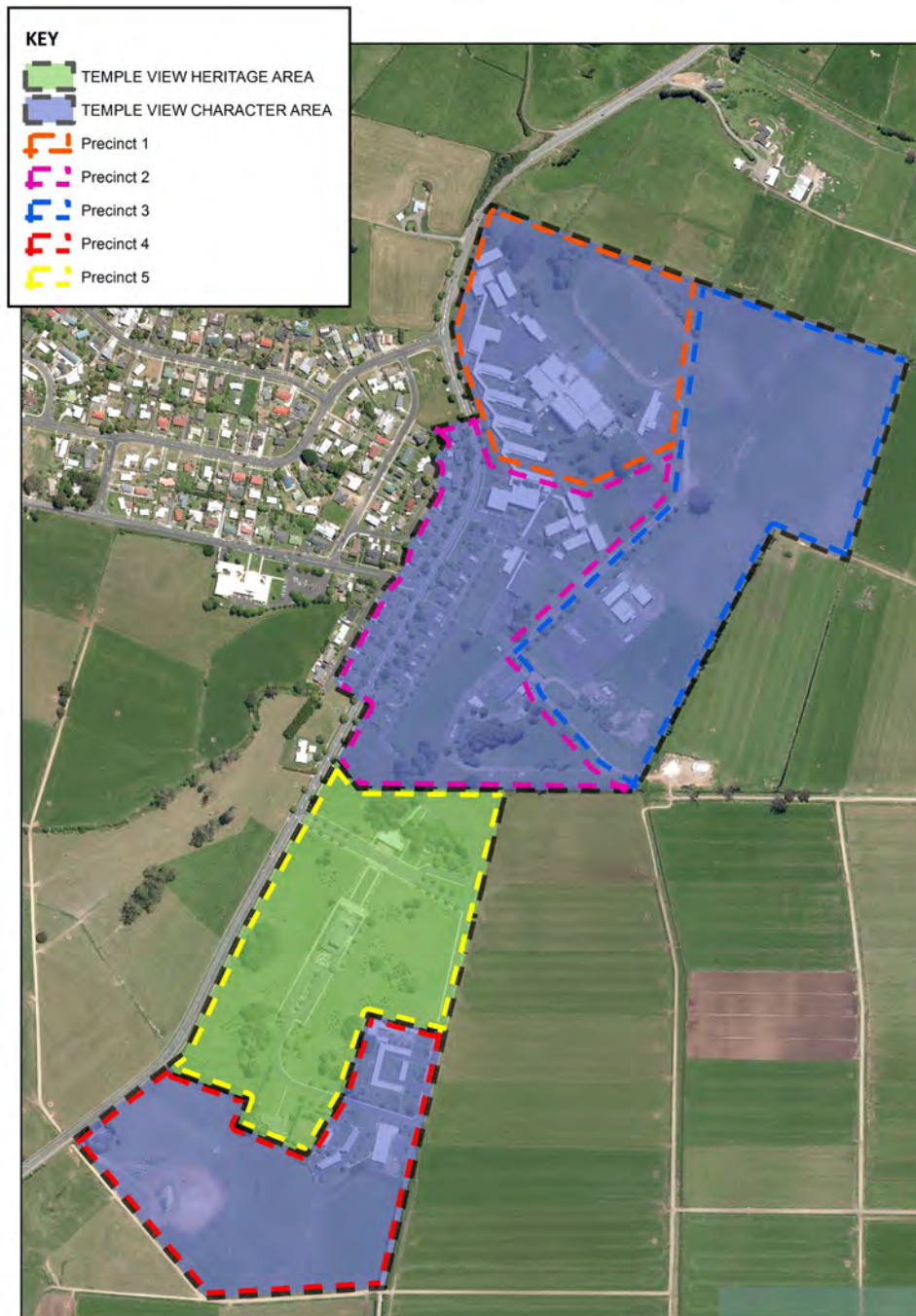

1.4.9.3 How to Use the Guide

Development of the precincts within the Temple View Zone will give form to the intended development and identity at a broad scale to the nature of the intended activities, their distribution and how they relate with the surrounding existing and proposed activities.

Development in the Temple View Character Area should reflect the activity mix for the four precincts. Similarly, development within the Temple View Heritage Area should reflect the activity mix within Precinct 5.

The design guidance below is split between the general design guidance that applies in the development of each precinct as well as identifying the locational specific design guidance for each.

1.4.9.4 Design Guidance

1.4.9.4.1 General Design Guidance

An application for an activity or activities within a precinct will need to address how the following outcomes will be achieved:

- a. How the overall design of the Precinct achieves the intended aesthetic and architectural coherence and is of a design, scale, form and character appropriate to its precinct location.
- b. How the arrangement of buildings, car parking, service areas and open spaces including provision for vehicular, cycle and pedestrian circulation will:
 - i. Be safe and convenient and achieve high standards of amenity
 - ii. Be functionally linked with and physically connected by walkways/cycleways to areas of open space within the Precinct
 - iii. Will enable safe pedestrian and cycle linkages to be created to the existing Temple View community
 - iv. Be aesthetically coherent and reinforce good urban design, particularly the orientation of buildings to outdoor public spaces, roads and utilising a variety of architectural elements consistent with the Temple View character
 - v. Give consideration to the identified heritage values of items listed within the District Plan.
- c. How the design and layout of roads will:
 - i. Ensure appropriate connections to existing and future roads
 - ii. Respond to the site's existing landform, vegetation, views, water courses (for the purposes of stormwater runoff) and areas of public open space
 - iii. Accommodate safe traffic speeds and sightlines for all road users (pedestrians, cyclists and motorists)
 - iv. Provide sufficient width to safely accommodate all road users, parking, footpaths, cycle ways, amenity landscaping and compliance with Council's Infrastructure Technical Specifications
 - v. Promote a consistent design theme to achieve high amenity values
 - vi. Have regard to the future design relationship between the road, adjoining land and adjacent precincts.
- d. How the location and size of future development sites have been identified in a manner that:
 - i. Responds to the context within which the development site is to be located, including roads, open space, pedestrian linkages, views and natural features
 - ii. Where they are for residential housing, is appropriate to the type and form of housing (medium density or high density) they will contain

- iii. Has regard to the relationship with existing grain and scale of developed areas
- iv. Gives consideration to the size, shape and aspect of the land, and its suitability for future development
- v. Integrates the development of sites within the relevant precinct as a whole.

1.4.9.4.2 Local Character Specific Design Guidance

In order to evaluate the appropriateness of any development within a Precinct an understanding of the character of the area is required. Much of the character of the Temple View Zone is derived from the cultural influence of the Temple, the associated former CCNZ campus and the evolution of this area with a variable building vernacular since the 1950s. In 2012, these characteristics provided a collective character that gave the Temple View Zone a superficial consistency of appearance which allowed the diverse components to be perceived as a whole. This has been used as the basis of determining the four sections which contributed significantly to the character of the area (refer to Figure 1.4.9g):

1. The Tuhikaramea Road Corridor
2. The Former Teacher Housing adjacent to the Tuhikaramea Road Corridor
3. The former Church College Campus
4. The Temple of The Church of Jesus Christ of Latter-day Saints.

Each of these sections contains elements which mark it as distinct from the others and warrant specific consideration. The following sections outline the specific elements or combination of elements that contributed to this character and offer suggestions as to how future development can respond and maintain that character.

Figure 1.4.9g: Temple View Local Character Areas



1. The Tuhikaramea Road Corridor

The original character of the Tuhikaramea Road Corridor was informed by the degree of consistency and repetition of the elements within a linear corridor when compared to a typical residential street. Although these elements were somewhat variable, typically the road corridor was defined by delineating elements such as a low masonry curtilage wall of uniform cream colour, metal balustrade atop a retaining wall or round timber bollards. These delineating elements typically contain some permutation of the simple combination of footpath, lawn, street trees and the road carriage way of Tuhikaramea Road.

At the northern entrance to Temple View, the sweeping driveway into the former CCNZ created an atypical entrance node with a broad swath of grass separating the development from the road corridor. This then returned to the more typical configuration of street trees, grass and footpath. The absence of a delineating element, combined with the curvature of the roadway, presented a less defined edge to the corridor. As a result a more expansive experience was obtained with the character being augmented by more lawn, palm trees and built form (the former privacy wall and covered walkway).

The original stature of street trees and extent of their canopy, when viewed from along the road alignment, formed an unbroken visual element, which reinforced the corridor experience. Elements to either side were partially visible beneath or above the canopy, but only readily seen when viewed perpendicular to the alignment of the street trees.

These are the characteristics that are to form the basis of all future developments.

Design Guidance:

- Where a low curtilage wall is proposed, it shall be similar to the original masonry materiality of Temple View and the standard tree and pathway berm configurations utilised along Tuhikaramea Road, especially within the former Teacher Housing Character Area.
- Where no curtilage wall is proposed, the standard berm configuration of trees, pathway and grass berm should be maintained where practical.
- Where no curtilage walls are utilised, any delineating elements, such as courtyard and walkway walls should allow visibility into and from the street. Where the delineating element is a building that building should address the street.
- Alternate design configurations may be considered where they maintain or enhance the spatial and visual integrity of the road corridor as it was in 2012 and provide best practice urban design solutions.
- The road alignment is to be maintained where possible so as to maintain the integrity of the visual corridor. Where, according to roading design best practice, improvements (such as roundabouts or traffic islands for traffic calming) are required, vertical deviations are preferred over horizontal deviations and any deviations should be contained as much as practicable within the existing road corridor.
- Encourage arrival features and/or gateway markers at key locations within the Tuhikaramea Road Corridor.

Figure 1.4.9h: 2012 photograph showing the Tuhikaramea Road Corridor



Figure 1.4.9i: 2012 photograph showing the Tuhikaramea Road Corridor



2. Former Teacher Housing Corridor on Tuhikaramea Road

The character of the former Teacher Housing closely associated with the Tuhikaramea Road Corridor was informed by a level of spatial consistency and repetition of residential scale architecture, materiality and colour. In addition to a consistent architectural vernacular, albeit with a degree of variation in architectural form, the former Teacher Housing layout provided a regular manner relative to their setback from the Tuhikaramea Road corridor and their spacing in-between.

The buildings were relatively modest in size being mainly one storey, some with basements, but varying in configuration with both single dwelling and duplex configurations. The buildings were oriented toward the Tuhikaramea Road Corridor with modest gates and simple direct pathways leading from the street to the houses.

While pedestrian access was afforded from Tuhikaramea Road, no parking was available on Tuhikaramea Road; garages and vehicular access were obtained only from the rear of these properties. Demarcation between individual properties was very limited and for the most part achieved through soft landscaping of a residential character.

The former Teacher Housing Character Corridor contains one building listed as a Heritage Item under this Plan, being the First House /George Biesinger House (H133).

Design Guidance

- Development within this area should respond with appropriate scale and setback, in a similar manner to the former residential setback alignment. The development should address Tuhikaramea Road, where practical and contiguous grades allow, and present an attractive frontage for passers-by. It should also offer an appropriate response to any adjoining open space.
- Consideration should be given to strategies to reduce or ameliorate the discontinuous grades.
- Where discontinuous grades prevent a direct visual connection with the street, alternative configurations which provide attractive street frontage treatments consistent with good urban design may be considered.
- Consideration should be given to alternative dwelling orientations which respond to the wider area and may result in a better urban design outcome for the overall development.
- Vehicle parking should be provided on Tuhikaramea Road.
- Pedestrian access should be provided from Tuhikaramea Road, with garages and vehicular access provided at the rear of the development.
- In addition to the above, development along the western side of Tuhikaramea Road should respond to the residential scale and grain of development to which it is immediately adjacent.
- Materials and colour should be compatible with the Temple View Character area.
- Development should respond to existing heritage buildings and consider scale, materials and contextual cues.

Figure 1.4.9j: 2012 photograph showing the typology of the original Teacher housing on Tuhikaramea Road



Figure 1.4.9k: 2012 photograph showing the typology of the original Teacher Housing on Tuhikaramea Road



3. The Former Church College of New Zealand Campus

The character of the former CCNZ Campus was informed by the distribution of built form over elevated topography within the wider park-like campus. The buildings were generally of similar institutional scale, one to two storey rectilinear form of a variety of construction materials. The majority of the built form reflected the combination of planned and opportune incremental development that occurred during the construction period (which spanned the 1950s till the late 1970s). This process involved the construction of a range of buildings, some specifically for or in support of the former CCNZ, while others formed part of a construction industry which developed on site during the initial construction period. Over time some of these buildings were removed, others re-purposed or modified, and others added. The application of a limited colour palette and tended landscape, provided a sense of consistency to disparate structures which might otherwise have appeared markedly different.

The distribution of the former CCNZ buildings followed either Tuhikaramea Road or the elevated terrace overlooking the campus sport fields, with the orientation of the buildings predominately to the north. Only the Matthew Cowley Administration building (now demolished) and the repurposed Wendell B Mendenhall Library addressed Tuhikaramea Road. These buildings and the now demolished privacy wall and covered walkway, when viewed from Tuhikaramea Road, conveyed the character of an institutional but introverted development.

When approaching Temple View from the north, the former CCNZ campus appeared as a cluster of large buildings that dominated the ridgeline with groups of specimen trees in the fore ground. The largest of these buildings was the now demolished David O McKay building. This building was flanked by an ordered array of similar coloured single and double-storied buildings. Although the buildings addressed the open space, with the playing field in the foreground providing a balance to the bulk of the buildings, the elevated position, limited windows and the expanse of surrounding open space conveyed a sense of introversion.

During the life of the former CCNZ Campus there was a consistent quality of maintenance of the surrounding landscape, with tidy groomed planting and specimen trees and stands of trees contained within a wider matrix of manicured lawn. In combination, the application of a limited colour palette and tended landscape provided a sense of coherence to the disparate structures. Overall the former CCNZ campus conveyed a coherent albeit introverted character in spite of the differences in architectural form.

The Character Area contains 5 buildings listed as a Heritage Item under this Plan being the GRB Building (H107), The Wendell B Mendenhall Library (H109), Kai Hall (H134), the Block Plant (H135) and the First House (H133). These buildings are valued because of their association with the former CCNZ and the missionaries involved in their construction. (See Appendix 8.)

This area also contains three stands of significant trees, which extends into the Heritage Area (being T62, T63 and part of T64). These stands are predominantly Kahikatea with some Titoki. These trees are scheduled under this Plan (see Appendix 9).

Design Guidance:

- Development within this area should contain either larger scale elements or clusters of buildings particularly along the northern ridgeline and Tuhikaramea Road frontages.
- Developments within this area should address the street by providing an active edge and “eyes on the street” with an attractive frontage for passers-by. This should be particularly emphasised for development on Tuhikaramea Road frontages.
- Garages and parking should be located such that they do not dominate the street frontage.
- Development should offer an appropriate response to any adjoining open space.
- Development should respond to existing heritage buildings and consider scale, materials and contextual cues.

Figure1.4.9I: 2012 photograph showing the former Church College of New Zealand campus



Figure 1.4.9m: 2012 photograph showing the former Church College of New Zealand campus



4. The Temple of the Church of Jesus Christ of Latter-day Saints

The Hamilton New Zealand Temple of the Church of Jesus Christ of Latter-day Saints (H108) is listed as a Heritage Item under this Plan. This building has not been ranked by Heritage New Zealand Pouhere Taonga but is valued because of its historic, cultural and architectural qualities.

The heritage values of this area are derived from the combination of the built and landscaped environment immediately surrounding the Temple, and the significant role the church has played in the physical, spiritual and social development of the local community and further afield. The Temple itself was the first in the southern hemisphere and is the focal point of the Church of Jesus Christ of Latter-day Saints in New Zealand.

The siting, design and landscape treatment of the Temple emphasise the vertical proportions of the building and create an impression of a monument. Other buildings within the area include the Visitors Centre, which has a strong visual relationship with the north elevation of the Temple and the central parking area, the Temple President's House which is visually connected by the walled car parking area to the south of the Temple, and the dormitory accommodation on the eastern side. Much of the character of this area is due to the relative absence of other buildings particularly when viewed from Tuhikaramea Road. Consequently, landscaping and the tree planting emphasise the dramatic and dominant position of the Temple in the local landscape. This tree planting includes trees that mark periods of occupation and development of the site by the Church.

This area contains part of a stand of significant trees, predominantly Kahikatea with some Titoki, which extend from the former CCNZ Character Area (being part of T64). In addition, it contains one Bunya-bunya tree (T65). These trees are scheduled under this Plan as significant.

Design Guidance:

- Development shall maintain the primacy of the Temple as the key focus of the area.
- Existing view shafts to the temple shall be maintained with respect to siting of buildings and landscape elements. Consideration may be given to developments and landscape elements within these view shafts which improve the overall amenity of the area with respect to the temple setting.

- Any development should consider and relate to the grain and distribution of development within the immediate area.
- Development should respond to existing heritage building and consider the scale, materials and contextual cues presented by this building.

Figure 1.4.9n: 2012 photographs showing the Temple of the Church of Jesus Christ of Latter-day Saints



1.5 Other Methods of Implementation

Many issues require a regulatory response through District Plan rules. The Resource Management Act also requires that regard be paid to other methods that may provide for more effective resource management, either on their own or in combination with rules.

This section outlines some of the methods, other than District Plan regulation, that will be developed and implemented to give effect to the District Plan's objectives. These 'other methods' may change and develop over the life of the District Plan as the Council progresses its strategic and annual planning responsibilities through its 10-year Long-Term Plan.

The following list of 'other methods' is an indication of the types of methods that contribute towards achieving District Plan objectives, the list is not exhaustive.

1.5.1 Regulatory Methods Outside the District Plan

- a) National Environmental Standards (air-quality standards, assessing and managing contaminants in soil, sources of human drinking water standards, telecommunication facilities, electricity transmission).
- b) National Policy Statements such as Electricity Transmission and Renewable Electricity Generation.
- c) Additional matters for consenting process for land affected by instability or inundation in the Resource Management Act, section 106.
- d) Civil Defence Emergency Management Act 2002 and Civil Defence Emergency Management Plans.
- e) Soil Conservation and Rivers Control Act 1941.
- f) Hazardous Substances and New Organisms Act 1996 and regulations.
- g) Reserves Act 1977 and the development, implementation and review Reserves Act 1977 Management Plans for Council reserves.
- h) Historic Places Act 1993.
- i) Wildlife Act 1953.
- j) Local Government Act 1974 and 2002.
- k) Electoral Act 1993 and regulations (e.g. election signs).
- l) Speed Limit Bylaws and safer speed areas.
- m) Traffic Bylaws (including restrictions on heavy vehicle transport routes).
- n) Hamilton City Council Bylaws.
- o) Enforcement action under the Resource Management Act.
- p) Consenting process and enforcement action under the Building Act 2004 and regulations.
- q) Public Works Act 1981 and designations.
- r) Land Transport Act 1998 and regulations.

-
- s) Utilities Access Act 2010.
 - t) Waikato Regional Policy Statement, Regional Plans and Strategies (e.g. Regional Land Transport Strategy).
 - u) Other Regional or Sub-Regional Strategies (e.g. Futureproof and Sub-Regional Three Waters Strategy).
 - v) Hamilton City Strategies (e.g. Access Hamilton and any associated action plans, Hamilton Urban Growth Strategy) and Plans.

1.5.2 Education and Advocacy

- a) Information from Land Information Memorandum/Project Information Memorandum.
- b) Information about contaminants in soil from:
 - i. Hamilton City Council's Selected Land-use Register.
 - ii. Waikato Regional Council's Register of Contaminated Land.
 - iii. Land Information Memorandum.
 - iv. Ministry for the Environment's Hazardous Activities and Industries List.
 - v. Ministry for the Environment's Contaminated Land Guidelines.
 - vi. Department of Labour's Health and Safety Guidelines on the Cleanup of Contaminated Sites.
 - vii. Industry health and environmental guidelines for assessing and managing contaminated sites.
- c) Guides and technical advice include information on:
 - i. Planting in the City, including recommendations on native planting.
 - ii. Earthworks.
 - iii. Good-quality urban design (e.g. *Vista* – highlights key urban design principles).
 - iv. Low-Impact Urban Design and Development principles.
 - v. Efficient water use and conservation (e.g. water-sensitive techniques including technologies such as low-flow shower heads and dual-flush toilets in new developments; water-efficient appliances (e.g. washing machines)).
- d) Promote the Hamilton Waste Management and Minimisation Plan including:
 - i. Waste audits and waste reduction to be carried out by high waste-generating activities.
 - ii. Re-use, recycling and disposal of waste including demolition materials.
- e) Advocate or promote:
 - i. Good-quality urban design. Specific advice is available through the Urban Design Panel.
 - ii. The incorporation of public art into the City.
 - iii. Water-sensitive approaches to water use and disposal and the benefits of energy- and water-efficiency mechanisms and changing behaviour.

-
- iv. Conservation of landscape, ecological values and gully restoration including voluntary protection of natural environments (e.g. QEII covenants).
 - v. Undergrounding of network utility services where possible.
 - vi. Improvements to passenger transport, walkable environments and the outcomes stated in the action plans developed under Access Hamilton.
 - vii. Broadband across the City.
 - viii. The benefits of a compact city coupled with good urban design and the advantages of medium-density and mixed-use development.
- f) Manage landowner expectations by clear and consistent information about:
- i. The constraints and opportunities of having a scheduled building/structure/site.
 - ii. The timing and sequencing of development of different parts of the City, in accordance with the Hamilton Urban Growth Strategy.
 - iii. Location of business and industrial activities in centres.
- g) Make available natural hazard information. Information about the risks of natural hazards should be provided to assist with the planning and preparation for natural hazard events.
- h) Build civic consciousness and pride through public promotion of sites that are of character-defining significance or unique to Hamilton and its history.

1.5.3 Council Projects and Initiatives (Subject to Long Term Plan and Annual Plan)

- a) Local Government Act 2002 policies and plans identifying community outcomes, establishing council financial policies, operational/management programmes and infrastructure plans (e.g. Long-term Plans, activity management plans, and budgets).
- b) Council work shows leadership in:
 - i. Co-ordination with other network utility operators regarding the location of new utility services.
 - ii. Urban design, accessibility, innovation, sustainability and optimisation.
 - iii. Best practice solutions.
- c) Council provides services such as:
 - i. Monitoring and enforcement.
 - ii. Transportation and Three Water infrastructure services.
 - iii. Inner-city free wireless internet.
- d) Implement the Public Art Plan and commission public art.
- e) Provide infrastructure in a manner that supports residential, business, industrial activities in preferred locations in accordance with City and Regional growth strategies.

-
- f) Develop Integrated Catchment Management Plans and/or water impact assessments for the long-term sustainable management of water resources and align Council works with those Catchment Management Plans and river bank stability programmes.
 - g) Maintain Hamilton City Infrastructure Technical Specifications, as a guide for acceptable engineering practice and design solutions.
 - h) Develop and implement Hamilton City Council Three Waters Management Plan.
 - i) Activity Management Plans for development and management of infrastructure to respond to City growth, renewal and enhanced service levels (including improved service levels to meet environmental objectives).
 - j) Observe responsibilities under Council's resource consents for water take, wastewater and stormwater management to increase water efficiency and the resulting slowing of growth in demand.
 - k) Undertake appropriate site investigation, assessment and design, and ensure good management practices are followed for Council-controlled infrastructure and community facilities.
 - l) Undertake demonstration projects (including public-private) for:
 - i. Mixed-use developments.
 - ii. Medium-density residential.
 - iii. Higher-density Central City living.
 - iv. Use of new technology in key public sites.
 - m) Implement Waikato-Tainui Raupatu Claims (Waikato River) Settlement Act 2010, (Hamilton City Council and other parties) through an integrated River Management Plan and associated joint management agreements and documents.
 - n) Facilitate public access from the Central City to the riverbank.
 - o) Develop a Master Plan for future development of the River Corridor.
 - p) Adopt appropriate place and street names, commemorative signs or pou.
 - q) Enhance identified Hamilton character areas, precincts and built and natural character.
 - r) Construct gateways, under the Gateways Policy, including securing land.
 - s) Develop and implement an Open Space Plan that will set the direction for the future provision of open space in Hamilton, taking account of City growth, demographic change and changes in recreation patterns. As well as providing for recreation needs the plan will acknowledge the role of open space in protecting areas of natural, cultural and historic value. The plan will emphasise the benefits of providing open space that serves multiple values and is connected to provide for pedestrian/cycle paths and ecological links.
 - t) Develop and implement action plans as described in Access Hamilton, including for parking, safety, travel demand, active travel and passenger transport.

- u) Secure necessary land, consents and designations for infrastructure (e.g. land for waste and recycling, and materials recovery activities; transport corridors; Three Waters networks).
- v) Develop an Opoia Precinct Framework to guide future development, which builds upon engagement with key stakeholders and addresses key issues including access, connectivity, residential amenity and mix of use.

1.5.4 Collaboration and Partnership

- a) Involve and consult with tangata whenua.
- b) Work with tangata whenua to improve community understanding of tikanga and customs (e.g. meaning and significance of waahi tapu sites, sensitivities about funeral activities near to food retail activities, scattering of ashes in waterways) .
- c) Work with Futureproof partnership to implement the Futureproof Strategy.
- d) Collaborate with the Waikato Regional Council, landowners and occupiers in the identification and assessment of potentially contaminated land and the remediation, management or containment of contaminated land.
- e) Collaborate with Waikato Regional Council, Civil Defence, and other territorial authorities, to collect and analyse natural hazard risk information.
- f) Collaborate with Waikato Regional Council to develop and implement public education and awareness programmes on natural hazards and their associated risks.
- g) Participate in any regional natural hazards forum to promote organisational integration and information sharing across jurisdictional and plan boundaries.
- h) Co-ordinate upgrades with other network utility operators so road corridor openings are minimised.
- i) Advocate for enhanced advertising standards in commercial centres and along industrial frontages.
- j) Develop public-private partnerships and joint ventures with the Crown and other councils, as appropriate.
- k) Work with infrastructure providers (e.g. Council, NZTA, Kiwi Rail) to develop infrastructure including roads, walkways and cycleways, passenger transport, water services, energy and telecommunications infrastructure, public space and reserves to complement land uses.
- l) Maintain an ongoing partnership between Hamilton City Council and event organisers.
- m) Maintain an ongoing relationship with the controlling authorities of major facilities.
- n) Work with key stakeholders to manage adverse social effects created by alcohol and substance abuse (e.g. liquor ban bylaws, discouraging liquor outlets from neighbourhood centres).
- o) Work with community groups in conservation and ecological restoration efforts within Hamilton City.

- p) Collaborate with Mighty River Power for design of infrastructure to allow for careful management of public walkways/cycleways within the operating range of the Waikato Hydro System.
- q) Engage with stakeholders involved in the movement of goods that exceed normal maximum size of loads to ensure their operating needs are being considered as part of managing the transport network.

1.5.5 Economic Instruments

- a) Develop Development Contributions and Financial Contributions policies that are consistent with the City's strategies, Hamilton City Long-term Plan, Annual Plans and Activity Management Plans.
- b) Development agreements between Council and developers for the funding of additional infrastructure and the use and upgrading of existing infrastructure.
- c) Cost recovery for services provided (fees and charges).
- d) Incentives (e.g. development bonuses, rebates, financial contributions for reserves, discounts) for proposals to:
 - i. Encourage high-level adoption of water-sensitive techniques, including financial incentives for water-efficient appliances or financial disincentives (e.g. water metering).
 - ii. Retain, plant or covenant native bush areas.