

TABLE OF CONTENTS

4	Featured Product: NRCR	26	Accessories
8	EZ Series	29	Accessory Compatibility Chart
10	EZTR Bundles	30	PVC Vent Accessories
14	NRCB Combination Boiler	32	Single Wall Vent Accessories
16	Commercial Rack Systems	38	Single Vent
18	Commercial Wifi Adapter	39	Concentric Vent
20	High Efficiency Models	40	DVC Vent Kits
22	Mid Efficiency & Commercial Models	42	New Noritz Support Site / Noritz University
24	Temperature Rise & Sizing Charts	43	ProCard +



NORITZ
25
YEAR
WARRANTY

UNMATCHED PERFORMANCE
NOW WITH THE
INDUSTRY'S BEST
WARRANTY

EZ TR75

GALLON TANK REPLACEMENT
NORITZ
TANKLESS WATER HEATERS

TRAILBLAZERS IN THE FIELD OF TANKLESS WATER HEATING

Noritz has been an innovator in the water heating industry for over 70 years. We introduced the first modern, electronically controlled tankless water heaters in 1981 and we remain the leader in energy savings and superior hot water delivery today.

Serving both homeowners & commercial users across the U.S. and Canada, Noritz America offers a broad range of tankless gas water heaters to meet the varying needs of its broad spectrum of customers.



NRCR

NORITZ RESIDENTIAL CONDENSING RECIRCULATION

Tech Specs		NRCR92DV	NRCR111DV
GQ Reference Number		GQ-C2660WXQ-FF US	GQ-C3260WXQ-FF US
BTU Input Range		18,000 - 165,000	18,000 - 199,900
Min / Max Flow Rate		0.5 GPM - 9.2 GPM	0.5 GPM - 11.1 GPM
Flow Rate at ΔT	30°F	9.2 GPM	11.1 GPM
	45°F	7.1 GPM	8.7 GPM
	80°F	4.0 GPM	4.9 GPM
Dimensions		27" (Height) x 18.5" (Width) x 14.1" (Depth)	
Weight		73 lbs.	
Connection Sizes	Water Inlet	3/4"	
	Hot Water Inlet	3/4"	
	Gas Inlet	3/4" (1/2" up to 60ft.)	3/4" (1/2" up to 40 ft.)
	Condensing Drain	1/2" Threaded	
Freeze Protection		Yes, pump circulation + resistance heat	
UEF		0.97	
Warranty		15 Year Warranty on Heat Exchanger, 5 year warranty on parts & 1 year reasonable labor	
Temp Settings	°F Mode	100-140° (In 5° Intervals) (9 Options)	
	°C Mode	37-48°C (In 1°C Intervals), 50-60°C (In 5° Intervals) (15 Options)	
Recirc Lengths		200 feet (1/2") / 500 feet (3/4")	
Venting Style		2" PVC (65 feet), 3" PVC (150 feet) or Flex Vent (35 feet)	
Wifi Compatible		In Development	

RECIRCULATION REIMAGINED

The Noritz NRCR series offers the latest cutting edge recirculation technology in a tankless water heater. This unit is equipped with high quality stainless steel heat exchangers for extreme corrosion and thermal stress resistance, giving your tankless a longer lifespan. In addition, a recirculation pump comes integrated with the unit to give you hot water faster and without the wait.

FEATURES

In addition to a new integrated recirculation pump, Noritz has redesigned and reformulated the heart of what makes the tankless work - The Heat Exchanger. By using a special stainless steel blend the heat exchanger has not only gained better efficiency, but also SUPERIOR durability.



INTEGRATED RECIRCULATION PUMP

- » 15 Year Heat Exchanger Warranty
- » Steady BTU Mode
- » Integrated Recirculation Pump
- » High Quality Stainless Steel Heat Exchangers
- » Best-in-Class Thermal Efficiency
- » Improved Smart Scheduling Interface
- » CA Title 24 Compliant
- » Easier Serviceability
- » On-Demand Mode
- » Heat Shrink Durability
- » Flex Vent Capable

NRCR

WHAT'S INSIDE



INDUSTRY LEADING WARRANTY

The NRCR features a 15 year warranty on its heat exchangers, which is one of the best warranties on a tankless with an integrated pump.

BEST-IN-CLASS EFFICIENCY

With a UEF rating of 0.97, the NRCR helps reduce harmful emissions by featuring one of the best thermal efficiencies in the tankless market.

REENGINEERED HEAT EXCHANGER

The NRCR's heat exchangers are composed of high quality stainless steel and designed for easier serviceability.

STEADY BTU MODE

An industry first, the NRCR's revolutionary burner control eliminates issues with high incoming water temperature in the summer by reducing effective BTU output to less than 5 KBTU.

INTEGRATED RECIRCULATION PUMP

Built with an integrated pump allowing a 1/2" loop with a length of up to 200 feet (or 3/4" up to 500 feet), the longest in the industry.

NRCR ACCESSORIES

Get ultimate comfort and control out of your NRCR when paired with any of our additional accessories.

COMING SOON



UPDATED FOR 2022

OUTDOOR VENT KIT

VC-6-1

Our new plastic outdoor vent cap is now easier to install and features a new elegant design. Compatible with EZ, NRCR, and NCC199CDV models.



UPDATED FOR 2022

2" SV CONVERSION KIT

SV-CK-2-1

Upgraded for 2022, our 2" single vent conversion kit upgrades direct vent (DV) installs to non-direct vent (SV) operation



CROSSOVER KIT

CSV-BPK

Our crossover kit brings recirculation to homes without a return line. Set your NRCR to crossover mode after installation and your home is ready for faster, hot water.



UNIVERSAL CONCENTRIC TERMINATION KIT

PVC-UCVK

The universal concentric vent kit allows for versatile venting installation for your tankless unit. It provides an up-and-out horizontal termination option for all GQ59, GQ60, and NRCB models.

WIRELESS ON-DEMAND BUTTON KIT FOR NRCR SERIES

Want to offer instant hot water with the press of a button? We've got you covered. The latest additions to the Noritz NRCR accessory line-up include a wireless on-demand button kit, an optional motion sensor, and an extra wireless transmitter. The featured products allow full utilization of the NRCR's on-demand recirculation system. Endless hot water just got easier.



1 x Wireless Motion Sensor

WIRELESS MOTION SENSOR

WLB-MS

Activate your tankless water heater from anywhere in your home when you come in range of the sensor.



1 x Receiver 2 x Transmitters

WIRELESS ON-DEMAND BUTTON KIT

WLB

Activate the NRCR's on-demand recirculation mode with this Title 24 compliant wireless push button. Kit contents include 2 wireless transmitters, wireless receiver, and a signal connector.



1 x Transmitter

EXTRA WLB TRANSMITTER

WLB-ET

One additional transmitter for WLB wireless on-demand button kit.

ADDITIONAL NRCR ACCESSORIES

MODEL NO.	CONTENTS	QTY
EZ2-CK	Flex Vent 2" Conversion Kit	1
EZ2-FVK-1	2" Flex Vent Kit (25 ft.)	1
EZ2FVK-2-1	2" Flex Vent Kit (35 ft.)	1
NC-1W	Wall Hanging Residential Condensate Neutralizer Kit	1
IHK-GB	On Demand Button	1

MODEL NO.	CONTENTS	QTY
IHK-RS	On Demand Switch	1
PC-10S	Pipe Cover	1
PVC-#LPT	Low Profile Termination Vent	1
RC-9018M	Remote Controller (to set timer manually)	1

FEATURED MODES

Equipped with a variety of customizable modes, the Noritz NRCR helps you simplify and personalize your home's hot water usage.

STEADY BTU MODE

An industry first, the NRCR's revolutionary burner control eliminates issues with high incoming water temperature in the summer by reducing effective BTU output to less than 5 KBTU. This prevents water temperature fluctuations while keeping your tankless running efficiently.

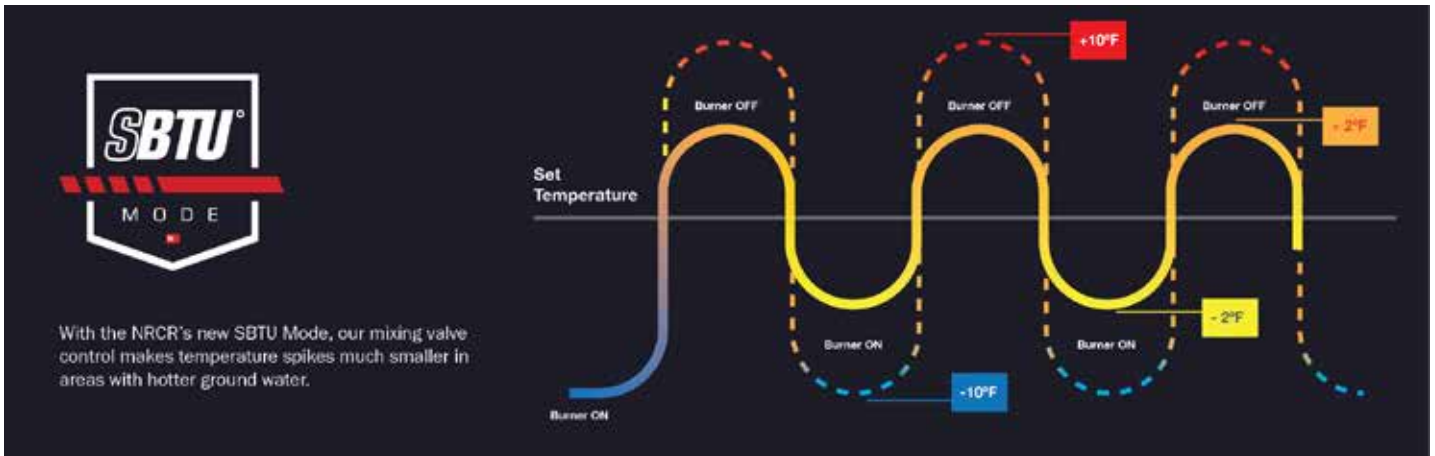

CROSSOVER MODE

Is your home missing a return line? Now you can experience home recirculation with the NRCR's Crossover Mode. Utilizing our Crossover Kit (Item# CSV-BPK, sold separately), you can enjoy the full benefits of a recirculation line without the need to install additional piping in your home.

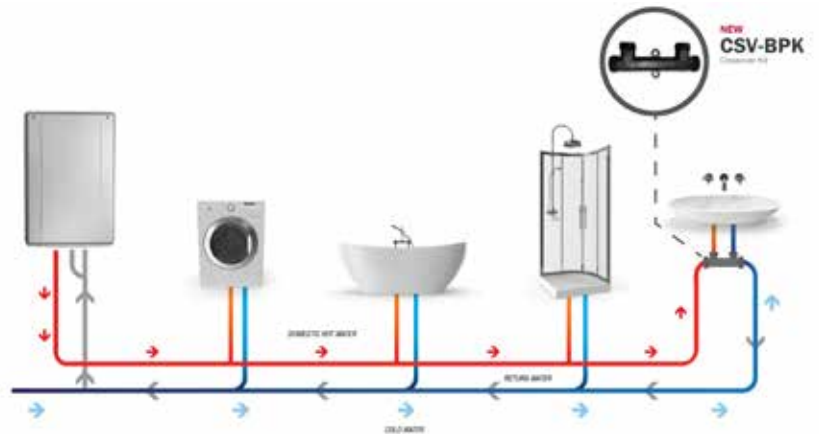

FULL RECIRCULATION

Built with an integrated pump, the NRCR brings your home hot water faster than ever by utilizing your dedicated return line.





EZ SERIES

Unmatched Performance NOW WITH THE INDUSTRY'S BEST WARRANTY

The Noritz EZ Series is the industry leader in tankless. Featuring top mounted connections to accommodate any installation scenario and manufactured with the highest quality materials, the EZ Series line is built to keep your home with hot water for years to come. Our industry-leading 25 year warranty is also just another reason why the EZ Series is the preferred choice for homeowners.

We believe in our product and want homeowners to have the latest and greatest tankless technology available. That's why Noritz has done what no one else has in the tankless industry: We've backed our EZ Series with a 25 year warranty. For more information, visit www.Noritz.com/EZWarranty

Tech Specs		EZ98DV	EZ111DV
GQ Reference Number		GQ-C2860WX-FF US	GQ-C3260WX-FF US
Min./Max. Btuh		18,000 - 180,000	18,000 - 199,900
Min/Max Flow Rate		0.5 GPM / 9.8 GPM	0.5 GPM / 11.1 GPM
Dimensions (Inches)		27.0 x 18.5 x 14.1	27.0 x 18.5 x 14.1
Weight (lbs)		70 lbs.	70 lbs.
UEF		0.97	0.97
Max. Hot Water Capacity		35°F Rise: 9.8 GPM	35°F Rise: 11.1 GPM
Connection Sizes	Water Inlet	3/4"	3/4"
	Hot Water Outlet	3/4"	3/4"
	Gas Inlet (1/2 in. capable)	3/4" (1/2 in. up to 50 ft.)	3/4" (1/2 in. up to 40 ft.)
Temp. Settings		100-140°F (In 5° intervals)	100-140°F (In 5° intervals)
Default Temp. Option		120, 125, 130, 140°F	120, 125, 130, 140°F
Warranty		25 Year Heat Exchanger. 5 year warranty on parts & 1 year reasonable labor	
Ultra Low NOx		Yes	
Quick Connect		Yes	
Remote Included		Yes	
Wifi Compatible		Yes	
High Altitude Approved		Up to 10,000 ft.	
Mobile Home Approved		Yes (OD or DV Install Only)	Yes (OD or DV Install Only)
PVC		2" or 3"	
Energy Star		Yes	
Pump Kit Compatible		Yes	





EZ SERIES

WHAT'S INSIDE

TOP MOUNTED WATER CONNECTIONS

Top mounted connections allow for previous water lines to be reconnected faster.

DUAL HIGH GRADE STAINLESS STEEL HEAT EXCHANGERS

Featuring greater resistance to corrosion and buildup, keeping your system running for years to come.

NEW STEADY BTU MODE

SBTU mode eliminates issues with high incoming water temperature in the summer by reducing effective BTU output to less than 5 KBTU, preventing water temperature fluctuations while keeping your tankless running efficiently.

QUICK CONNECT

Get your hot water up and running faster with our EZ installation process.

WIRELESS CAPABILITY

Combined with the Noritz Connect app, users have control of all heater functions and diagnostic tools.

1/2" GAS LINE COMPATIBLE

Compatible with most installations, the 1/2" gas line is found underneath the unit for a more convenient install.

KEY SPECS

Model	EZ98	EZ111
Max Hot Water Capacity	9.8	11.1
UEF	0.97 UEF	
BTU	180,000	199,900









EZTR BUNDLES

ALL-IN-ONE RESIDENTIAL TANK REPLACEMENT BUNDLE

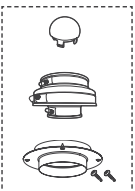
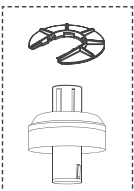
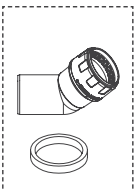
The Noritz EZTR bundles include select accessories to help get you up and running with your installation. Each model is designed for different water demands for residential applications.

ALL NECESSARY PARTS INCLUDED

Each EZTR50 and EZTR75 bundle includes the heater itself, a flex vent conversion kit (25 feet of 2-inch flex), an isolation valve kit, and a startup guide. The EZTR40 also comes with a heater, vent kit, and service valves.

<p>Bag 1</p> <p>Flex Feeder Base Junction Support Base Junction Adapter</p> 	<p>Bag 2</p> <p>Top Flex Support Rain Cap</p> 	<p>Bag 3</p> <p>Rigid 45 Elbow 2" Flex Vent Gasket</p> 	<p>EZ2-CK</p> <p>Required To Utilize Flex Vent Kits For EZ98/111 and NRCR</p>  <p>Flex Vent 2" Conversion Kit</p>
<p>Flex-Vent Conversion Kit (EZTR50 & EZTR75 Only)</p> 	<p>Isolation Valves/PRV included</p> 	<p>25 ft. 2" Flex Vent</p> 	<p>Aluminum Flex Sleeve</p> 



EZTR50 TANKLESS BUNDLE

The EZTR50 package comes with an EZ98DV tankless, plus all the aforementioned components, for replacement of a 50-gallon tank water heater.



EZTR75 TANKLESS BUNDLE

The EZTR75 package contains an EZ111DV tankless, plus all the aforementioned components, for replacement of a 75-gallon tank water heater.



EZTR40 TANKLESS BUNDLE

The EZTR40 package is designed for quick and direct indoor replacement of 40-gallon tank water heaters.

TECH SPECS

Vents Through Existing, Round 3" Or 4" B-Vent

2" Flex



PVC, 2" Flex, OD or SV Convertible



Model	EZTR40	EZTR50	EZTR75
GQ Reference Number	NRC663-FSV	EGQ-C2860WX-FF US	EGQ-C3260WX-FF US
Vent Type	Flex Vent	Convertible Vent	Convertible Vent
Dimensions (inches)	27.2 x 18.3 x 9.4	27.0 x 18.5 x 14.1	27.0 x 18.5 x 14.1
Weight (lbs)	50 lbs.	70 lbs.	70 lbs.
Min. / Max. Btuh	15,000 - 120,000	18,000 - 180,000	18,000 - 199,900
UEF	0.87	0.97	0.97
Max. Hot Water Capacity	6.6 GPM	9.8 GPM	11.1 GPM
Water Inlet	3/4"		
Hot Water Outlet	3/4"		
Gas Inlet (1/2 in. capable)	1/2" (1/2 in. up to 100 ft.)	3/4" (1/2 in. up to 50 ft.)	3/4" (1/2 in. up to 40 ft.)
Temp. Settings	115 - 140°F (In 5° Intervals)	100-140°F (In 5° intervals)	
Warranty	12 year warranty on heat exchanger, 5 year warranty on parts, & 1 year reasonable labor	INDUSTRY LEADING 25 YEAR HEAT EXCHANGER WARRANTY 5 year warranty on parts & 1 year reasonable labor	
Ultra Low NOx	Yes		
Quick Connect	No	Yes	
Remote Included	Digital Display	Yes	
Min. / Max. Flow Rate	0.5 GPM / 6.6 GPM	0.5 GPM / 9.8 GPM	0.5 GPM / 11.1 GPM
High Altitude Approved	Up to 3,500 ft.	Up to 10,000 ft.	
Indoor / Outdoor	Indoor Only	Indoor / Outdoor	
Wifi Compatible	Yes		
Pump Kit Compatible	No	Yes	
EZTR / EZ Series Options			
Bundle	Yes	Yes (Model EZTR50)	Yes (Model EZTR75)
Sold Separately	No	Yes (Model EZ98)	Yes (Model EZ111)

EZ SERIES ACCESSORIES

The Noritz EZ Series adapts to your installation needs, providing professional installers and their homeowner-customers with a wider range of tankless options, covering the majority of residential, tank-replacement opportunities. Choose the way you install the EZ98 or EZ111 with any of these available accessories. Tackle a wide variety of install scenarios with the most versatile tankless on the market.

Single Vent

COMING SOON

Accessories required for this install:

UPDATED FOR 2022

SV-CK-2-1

2" SV Conversion Kit

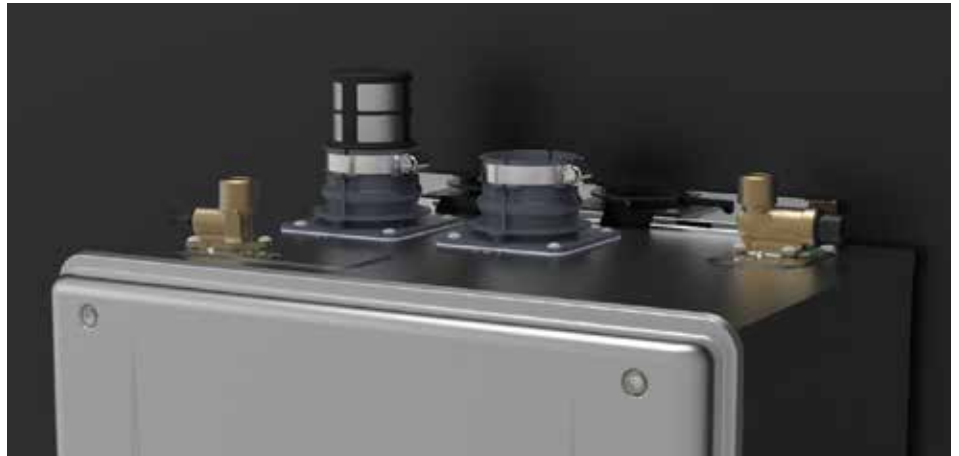

Direct Vent

⇒ Utilizing 2" PVC

Additional optional accessories:

PVC-2CT (2" PVC)
PVC-3CT (3" PVC)

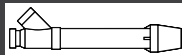

Outdoor Installation

UPDATED FOR 2022

Accessories required for this install:

⇒ **VC-6-1**

Outdoor Vent Cap
(Not available for EZTR40)



EZ SERIES FLEX VENT KITS

EZTR 2" FLEX VENT KIT (25 FEET)

Accessories required for this install:

EZ2FVK-1

Bag 1



- Flex Feeder
- Base Junction Support
- Base Junction Adapter

Bag 2

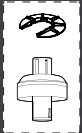

- Top Flex Support
- Rain Cap

Bag 3

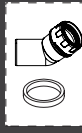

- Rigid 45° Elbow
- 2" Flex Vent Gasket



25 Foot
2" Flex Vent

EZ2-CK

Required To Utilize Flex Vent Kits For EZ98/111 and NRCR



Flex Vent 2"
Conversion Kit

25 Ft. Flex Vent Included



Optional Accessory
EZ2-DK-1 (25')



Optional Diffuser Kit
(For use if keeping existing rain cap)

EZTR 2" FLEX VENT KIT (35 FEET)

Accessories required for this install:

EZ2FVK-2-1

Bag 1



- Flex Feeder
- Base Junction Support
- Base Junction Adapter

Bag 2



- Top Flex Support
- Rain Cap

Bag 3



- Coupler Retainer
- 2" Flex Vent Gasket
- O-Ring Lubricant
- 45° Elbow

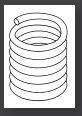

- 35 Foot
2" Flex Vent

EZ2-CK

Required To Utilize Flex Vent Kits For EZ98/111 and NRCR



Flex Vent 2"
Conversion Kit

35 Ft. Flex Vent Included



Optional Accessory
EZ2-DK-2 (35')



Optional Diffuser Kit
(For use if keeping existing rain cap)

Install Through Existing B-Vent Up To 35 Feet (Optional, Sold Separately)

WIRELESS COMPATIBILITY

Accessories required for this install:



⇒ **NWC-ADAPTER**
Wireless Adapter



⇒ NORITZ® CONNECT

Pair our NWC-Adapter with the Noritz Connect App for wireless control of your tankless water heater.

For more information visit
WIFI.NORITZ.COM



COMBINATION BOILER

NRCB

NRCB180 | NRCB199

Model		NRCB180DV	NRCB199DV
GQ Reference Number		GHQ-C2801WX-FF US	GHQ-C3201WX-FF US
Gas Input Rate (Domestic Hot Water Mode)	Max	180,000 BTUH	199,900 BTUH
	Min	18,000 BTUH	18,000 BTUH
Gas Input (Heating Mode)	Max	100,000 BTUH	120,000 BTUH
	Min	18,000 BTUH	18,000 BTUH
Hot Water Capacity Flow Rate	35° F Rise	9.8 GPM	11.1 GPM
	45°F Rise	7.5 GPM	8.4 GPM
	80°F Rise	4.3 GPM	4.7 GPM
Installation		Indoor / Outdoor with VCK-NRCB (sold separately)	
Flue System		Sealed Combustion Direct Vent, Single Vent	
Gas Pressure	NG	3.5" WC-10.5" WC	
	LP	8.0" WC-14.0" WC	
Heat Exchanger	Primary	SS316L (Austenite)	
	Secondary	SS316L (Austenite)	
	Plate Type Heat Exchanger	SCR (Austenite)* *Stress Corrosion Resistant	
DHW Heating Priority		Simultaneous Heating and Domestic Capable	
AFUE		95%	
Wifi Compatible		In Development	

THE NEW HERO IN HOME HEATING AND HOT WATER

Most combination boilers prioritize the call for hot water while your home is being heated. This causes your home heating to go cold while things like the shower are running. The NRCB is the industry's first to be able to handle both simultaneously to provide ease and comfort.

FEATURES

- » Corrosion Resistant
- » Self Regulating Flow
- » 2" and 3" PVC, CPVC and PP Venting Capable
- » 11:1 Turndown Ratio
- » 1/2 Inch Gas Line Capable
- » High Grade Stainless Steel Heat Exchangers
- » Outdoor Temperature Reset Sensor
- » External Pump Terminal
- » Scalding Prevention for DHW Safety
- » Up to 11.1 GPM
- » High Capacity Internal Pump
- » Maintains Set DHW Temp. in All Conditions
- » Simultaneous DHW and Heat¹
- » Larger hot water demand can be connected with EZ Series

NRCB180 | NRCB199

COMBINATION BOILER



ULTRA LOW EMISSIONS BY PREMIX BURNER

The NRCB's Premix Burner help eliminate harmful emissions into the environment.

ALL STAINLESS STEEL HEAT EXCHANGERS (3 TOTAL)

Made with high quality stainless steel, these main components are built to last and bring you years of heating and hot water.

SIMULTANEOUS OPERATING OF DHW AND HEATING¹

The NRCB is the industry's first tankless combi boiler to offer simultaneous DHW and home heating.

HIGH DELIVERING CAPACITY OF DHW (MAX 199K / 180K BTUH)

High delivery capacity ensures your family is never without hot water again.

STABILITY AND QUICK TEMPERATURE CONTROL OF DHW AND HEATING

Prevent temperature spikes with our built-in stability and quick temp control.

¹Dependent on heating and DHW temperatures



COMMERCIAL RACK SYSTEM (CR)

Preengineered Rack Systems

Noritz offers a commercial water heating solution that gives you all the benefits of tankless water heaters in one easy to install pre-fabricated package. Ideal for an existing or planned boiler and storage tank replacement, the Noritz Commercial Rack (CR) system (formerly CWHS) is made to provide a true alternative or supplement to the old storage tank setup.

Upgraded for 2020, the Noritz CR Commercial Rack System has been redesigned for maximum performance and ease of installation. The CR is a pre-fabricated racking system for use in flat rooftop or mechanical room applications for commercial multi-systems. A new low profile design and a variety of installation options make this new rack system ideal for business owners looking to replace outdated storage tanks.

ADDITIONAL OPTIONS AND ACCESSORIES



WH-3

Wall Hanging Rack

The new wall hanging rack allows installers to accommodate for existing conduit and piping without interference, reducing additional installation time. A new floor stand also comes included which allows for easy positioning while fixing to a wall.



CR60-WK

CR60 Wheel Kit

Noritz CR60 Wheel Kit is designed to simplify logistics of moving Noritz Commercial Racks from the crate to the mechanical room. Designed to last, the wheel kits are compatible to move all Noritz Commercial Rack configurations for years to come.



CR60-CA

2020 CR System Update

The updated Noritz CR Commercial Rack System brings new features designed to create a hassle free and easy installation. The CR system update comes with a redesigned gas header with built-in gas sediment traps and an additional shutoff valve, simplifying both installation and service.

FEATURES

NEW LOW PROFILE DESIGN

Redesigned with lower center of gravity for increased stability and easier transportation.

NEW WALL MOUNT OPTION

The redesigned wall mounted option allows for more space savings without sacrificing performance.

REDUCED INSTALL TIME

Pre-piped condensate manifold and condensate line along with pre-wiring required for multi-systems reduces installation time.

SIMPLIFIED VENTING

Built-in non-return valve allows for common venting up to 6 units on a single manifold without the need for external accessories.

EASY SCALABILITY

Standardized water and gas lines allow easy connection of multiple rack systems in-line.

FEATURES



EFFICIENCY

Each CR system comes standard with the ultra-efficient NCC199CDV model unit, rated at 0.97 UEF. Fully modulating, with turn-down ratios of up to 67:1², the CR system provides exceptional energy savings potential over a storage tank set up.

With all of these benefits plus the Noritz trademark quality, the Noritz CR system provides a true business-friendly replacement for any existing system.

¹Floor mounted racks only

²With one 6 unit system CR rack. Multiple racks can be combined together to get turndown ratios of up to 300:1 with 24 units and the SC-401-24M system controller.

³NWCC-ADAPTER



REDUNDANCY

Built-in redundancy from using multiple Noritz water heaters ensures continuous hot water, even in the worst case of a unit going down. Isolation valves (included) allow for easy maintenance or service without interrupting hot water service to the rest of the building. The pre-installed (included) system controller monitors and controls the units to ensure even wear and proper operation of each unit.

With the optional wireless adapter³, you can further enhance system reliability by monitoring the units at the touch of a finger and receiving service alerts automatically.



FLEXIBILITY

The new CR offers unmatched versatility and flexibility compared against a boiler or storage system. At 30" in depth, the CR system can fit through any standard 32" doorway. Able to be installed indoors or outdoors, floor-mounted or wall-mounted, the possibilities for reducing building footprint are extensive. Indoor installations can be vented with PVC, CPVC, or PP, either horizontally or vertically, and convertible to allow either room air or direct vent combustion air options.

DIMENSIONS

Item Number	Rack Type	UPC	Included Main Components		Cold / Hot Water & Gas Manifold				Rack Dimensions			Weight (lbs)
			GQ-C3260WZ-FF US	SC-401-6M	Cold	Hot	Condensate Drain Manifold	Gas Manifolds	L	D	H	
CR60-WH-2-LP	2 Unit Wall Hanging, LP	860003319932	2	1	2"	2"	3/4"	2"	54 1/4"	17"	44"	259
CR60-WH-2-NG	2 Unit Wall Hanging, NG	860003319949										
CR60-WH-3-LP	3 Unit Wall Hanging, LP	860003319956	3	1	2"	2"	3/4"	2"	78"	17"	44"	386
CR60-WH-3-NG	3 Unit Wall Hanging, NG	860003319963										
CR60-FS-4-LP	4 Unit Free Standing, LP	860003319970	4	1	2"	2"	3/4"	2"	54 1/4"	30"	56 3/4"	444
CR60-FS-4-NG	4 Unit Free Standing, NG	860003319987										
CR60-FS-5-LP	5 Unit Free Standing, LP	850018743099	5	1	2"	2"	3/4"	2"	78"	30"	56 3/4"	560
CR60-FS-5-NG	5 Unit Free Standing, NG	850018743082										
CR60-FS-6-LP	6 Unit Free Standing, LP	817000013752	6	1	2"	2"	3/4"	2"	78"	30"	56 3/4"	641
CR60-FS-6-NG	6 Unit Free Standing, NG	860003319994										

HOT WATER SUPPLY CAPACITY

Item Number	Heater Qty	Heater Configuration	Min BTU/hr Input	Max BTU Input	Hot Water Capacity (GPM)						
					50°	60°	70°	80°	90°	100°	110°
CR60-WH-2-LP	2	Wall Hanging In-Series	18,000	399,800	15.7	13.1	11.2	9.8	8.7	7.8	7.1
CR60-WH-2-NG											
CR60-WH-3-LP	3	Wall Hanging In-Series	18,000	599,700	23.5	19.6	16.8	14.7	13.1	11.8	10.7
CR60-WH-3-NG											
CR60-FS-4-LP	4	Free Standing 2x2 Back to Back	18,000	799,600	31.3	26.1	22.4	19.6	17.4	15.7	14.2
CR60-FS-4-NG											
CR60-FS-5-LP	5	Free Standing 3x2 Back to Back	18,000	999,500	39.2	32.7	28.0	24.5	21.8	19.6	17.8
CR60-FS-5-NG											
CR60-FS-6-LP	6	Free Standing 3x3 Back to Back	18,000	1,199,400	47.0	39.2	33.6	29.4	26.1	23.5	21.4
CR60-FS-6-NG											



COMMERCIAL WIFI ADAPTER

The new Noritz NWCC-ADAPTER allows businessowners and contractors to take full control of their commercial tankless system. The NWCC adapter connects with our dedicated app to give users monitoring, troubleshooting, and more. In addition, the NWCC Adapter also comes as a packaged option with a Noritz System Controller (SC-#) to get your unit running right out of the box.

FEATURES

SERVICE ALARMS

React proactively. Prevent critical errors with warning alarms for necessary service.

MULTI-SITE MONITORING

Simultaneous system monitoring. Up to 6 per adapter through our dedicated dashboard.

SITE-SPECIFIC NOTIFICATIONS

Notifications for any installation. Set your parameters and cater your alerts to your business.

ALERTS DIRECTLY TO YOU

Email and text message alerts. Get notifications across desktop and mobile.

LINK UP TO 24 UNITS WITH OUR SYSTEM CONTROLLER BUNDLES

No hot water project demand is too large for our NWCC Commercial Wifi Adapter and System Controller bundles. These bundles come with everything needed to link your commercial install for up to 6, 12, or 24 tankless units. (See page 28 for more details)



System Controller



NWCC-Adapter

HOW IT WORKS

⇒ ERROR DATA COLLECTED WHEN A PROBLEM IN YOUR SYSTEM OCCURS

When problems arise in your commercial units, the Noritz NWCC adapter immediately transmits all error information.



⇒ CONTRACTOR IS NOTIFIED ABOUT ERROR VIA MOBILE APP AS WELL AS DESKTOP ALERTS

The NWCC adapter utilizes our dedicated app and immediately sends this information over the web to contractors and business owners. This allows them to take action or be proactive to prevent further issues.

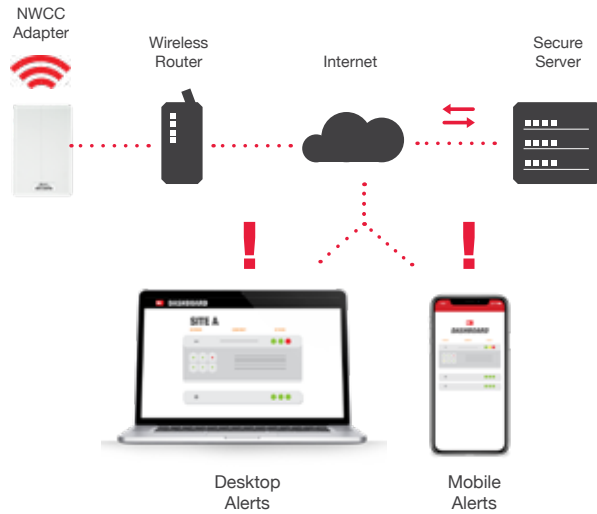

ADDITIONAL FEATURES

KEEP TABS ON WHAT MATTERS



With the NWCC-Adapter you can keep track of your Noritz Commercial installation over the internet. Whether it's one site or multiple sites, the organized dashboard and alarm system will keep you updated when you need to know.

< FAN SPEED MM 49 >
IS GREATER THAN "100"



Alert! Fan Error.
Unit # NCC199CDV



CUSTOM LOGIC BASED ALARMS

Customize when you want to get a preventative alarm to your preference. Not sure what you want to set it at? We've provided you default templates you can tweak so you can choose alarms you want to get via text or email.

FILTER AND FIND



Sift through information fast and effectively with custom dashboard setups and filter by the information you want to know. Want to see only the heaters with errors? Or perhaps you want to see only the heaters in a certain territory or district.

ORGANIZE AND CONQUER

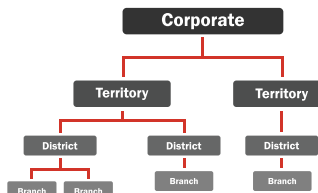

With the Commercial dashboard you can maintain your internal organization structure. Setup users and dashboards based off hierarchy and control who can see what.

EZ & NRC



Model	EZ111DV	NRC111DV	NRC111OD	EZ98DV	NRC98DV
GQ Reference Number	GQ-C3260WX-FF US	GQ-C3257WX-FF US	GQ-C3257WX US	GQ-C2860WX-FF US	GQ-C2857WS-FF US
Vent Type	Versatile Venting	DV	OD	Versatile Venting	DV
SV Conversion	Yes	Yes	N/A	Yes	Yes
Dimensions (Inches)	27.0 x 18.5 x 14.1	24.2 x 18.3 x 9.4	24.2 x 18.3 x 9.4	27.0 x 18.5 x 14.1	24.2 x 18.3 x 9.4
Weight (lbs)	70 lbs.	68 lbs.	66 lbs.	70 lbs.	58 lbs.
Min./Max. Btuh	18,000 - 199,900	16,000-199,900	16,000-199,900	18,000 - 180,000	16,000 - 180,000
UEF	0.97	0.91	0.91	0.97	0.91
Max. Hot Water Capacity	35°F Rise: 11.1 GPM			35°F Rise: 9.8 GPM	35°F Rise: 9.8 gpm
Water Inlet	3/4"				
Hot Water Outlet	3/4"				
Gas Inlet (1/2 in. capable)	3/4" (1/2 in. up to 40 ft.)			3/4" (1/2 in. up to 50 ft.)	
Temp. Settings	100-140°F (In 5° intervals)				115-140°F (In 5° Intervals)
Default Temp. Option	120, 125, 130, 140°F				
Warranty	25 YEAR HEAT EXCHANGER, 5 year warranty on parts & 1 year reasonable labor	12 year warranty on heat exchanger, 5 year warranty on parts & 1 year reasonable labor (Residential Installs)		25 YEAR HEAT EXCHANGER, 5 year warranty on parts & 1 year reasonable labor	12 year warranty on heat exchanger, 5 year warranty on parts & 1 year reasonable labor (Residential Installs)
Ultra Low NOx	Yes				
Quick Connect	Yes				
Remote Included	Yes				
Min/Max Flowrate	0.5 GPM / 11.1 GPM	0.5 GPM / 11.1 GPM		0.5 GPM / 9.8 GPM	0.5 GPM / 9.8 GPM
Wifi Compatible	Yes				
High Altitude Approved	Up to 10,000 ft.	Up to 8,000 ft.		Up to 10,000 ft.	Up to 8,000 ft.
Mobile Home Approved	Yes (OD or DV Install Only)				
PVC	2" or 3"	3" or 4"	No	2" or 3"	3" or 4"
Energy Star	Yes				
Pump Kit Compatible	Yes				

Vent Type

DV - PVC, CPVC, PP Vent
 SV - Stainless Steel Vent
 DVC - Concentric, Stainless Steel Vent
 OD - Outdoor Vent

Versatile Venting

See page 9-11

Approvals

Residential





Model	NRC98OD	NRC71DV	NRC71OD	NRC66DV	NRC66OD
GQ Reference Number	GQ-C2857WS US	N/A	N/A	N/A	N/A
Vent Type	OD	DV	OD	DV	OD
SV Conversion	N/A	Yes	N/A	Yes	N/A
Dimensions (Inches)	24.2 x 18.3 x 9.4	23.6 x 13.8 x 6.7	20.5 x 13.8 x 6.7	23.6 x 13.8 x 6.7	20.5 x 13.8 x 6.7
Weight (lbs)	57 lbs.	41 lbs.	40 lbs.	39 lbs.	36 lbs.
Min./Max. Btuh	16,000 - 180,000	15,000 - 157,000	15,000 - 157,000	15,000-120,000	15,000-120,000
UEF	0.92	0.89	0.89	0.89	0.89
Max. Hot Water Capacity	35°F Rise: 9.8 gpm	30°F Rise: 7.1 gpm	30°F Rise: 7.1 gpm	30°F Rise: 6.6 gpm	30°F Rise: 6.6 gpm
Water Inlet	3/4"				
Hot Water Outlet	3/4"				
Gas Inlet (1/2 in. capable)	3/4" (1/2 in. up to 50ft)	3/4" (1/2 in. up to 70ft)		1/2" (1/2 in. up to 100 ft)	1/2" (1/2 in. up to 100 ft)
Temp. Settings	115-140°F (In 5° Intervals)			100 - 140°F (In 5° Intervals)	100 - 140°F (In 5° Intervals)
Default Temp. Option	120, 125, 130, 140°F	120, 130, 135, 140°F		120, 130, 135, 140°F	120, 130, 135, 140°F
Warranty	12 year warranty on heat exchanger, 5 year warranty on parts & 1 year reasonable labor (Residential Installs)				
Ultra Low NOx	Yes				
Quick Connect	Yes	No			
Remote Included	Yes	Digital Display			
Min/Max Flowrate	0.5 GPM / 9.8 GPM	0.5 GPM / 7.1 GPM	0.5 GPM / 7.1 GPM	0.5 GPM / 6.6 GPM	0.5 GPM / 6.6 GPM
Wifi Compatible	Yes				
High Altitude Approved	Up to 8,000 ft.				
Mobile Home Approved	Yes (OD or DV Install Only)				
PVC	No	3"	No	3"	No
Energy Star	Yes				
Pump Kit Compatible	Yes	No			

For technical support, contact us at
(866)766-7489

Visit us at
Support.Noritz.com

› Mid Efficiency (Non Condensing)

NR



Model	NR98DVC	NR98SV	NR98OD	NR83DVC	NR83OD	NR66OD	NR50OD
GQ Reference Number	GQ-2857WX-FFA US	GQ-2857WX-F US	GQ-2857WX US	GQ-2457WS-FFA US	GQ-2457WS US	N/A	N/A
Vent Type	DVC	SV	OD	DVC	OD	OD	OD
SV Conversion	N/A						
Dimensions (Inches)	23.6 x 13.8 x 9.4	23.6 x 13.8 x 9.4	23.6 x 13.8 x 9.4	23.6 x 13.8 x 9.4	23.6 x 13.8 x 9.4	20.5 x 13.8 x 6.7	20.5 x 13.8 x 6.7
Weight (lbs)	58 lbs.	54 lbs.		49 lbs.	45 lbs.	35 lbs.	32 lbs.
Min./Max. Btuh	16,000 - 199,900			18,000 -180,000		15,000-140,000	15,000-120,000
UEF	0.82						
Max. Hot Water Capacity	45°F Rise: 7.5 gpm			30°F Rise: 8.3 gpm		30°F Rise: 6.6 gpm	30°F Rise: 5.0 gpm
Water Inlet	3/4"						
Hot Water Outlet	3/4"						
Gas Inlet (1/2 in. capable)	3/4" (1/2" up to 40ft)			3/4" (1/2" up to 50ft)		3/4" (1/2" up to 80ft)	1/2" (1/2" up to 100ft)
Temp. Settings	100-140°F (In 5° Intervals)			115-140°F (In 5° Intervals)			
Default Temp. Option	120, 125, 130, 140°F					120, 130, 135, 140°F	
Warranty	12 year warranty on heat exchanger, 5 year warranty on parts & 1 year reasonable labor* (Residential Installs)						
Ultra Low NOx	Yes						
Quick Connect	Yes					No	No
Remote Included	Yes					Digital Display	
Min/Max Flowrate	0.5 GPM / 9.8 GPM			0.5 GPM / 8.3 GPM		0.5 GPM / 6.6 GPM	0.5 GPM / 5.0 GPM
Wifi Compatible	Yes						
High Altitude Approved	Up to 8,000 ft.						
Mobile Home Approved	Yes	No	Yes				
PVC	No						
Energy Star	No						
Bundle Kit	Yes	No		Yes	No		No
Pump Kit Compatible	Yes					No	

Commercial Models

Commercial Models



	Condensing			Non-Condensing		
Model	NCC300OD	NCC300DV	NCC199CDV	NC380SV	NC199DVC	NC199OD
GQ Reference Number	GQ-C5032WZ US	GQ-C5032WZ-FF US	GQ-C3260WZ-FF US	N/A	GQ-2857WZ-FFA US	GQ-2857WZ US
SV Conversion	N/A	Yes	Yes	No	N/A	N/A
Vent Type	OD	DV	DV / OD	SV	DVC	OD
Dimensions (Inches)	32.7 x 18.9 x 14.2	32.7 x 18.9 x 14.2	27.0 x 18.5 x 14.1	29.7 x 19.1 x 11.8	23.6 x 13.8 x 11.0	23.6 x 13.8 x 9.4
Weight (lbs)	108 lbs.		70 lbs.	106 lbs.	58 lbs.	54 lbs.
Min./Max. Btuh	15,000 - 300,000		18,000 - 199,900	22,500 - 380,000	16,000 - 199,900	
Thermal Efficiency / UEF	97%		0.97 UEF	NG: 80% LP: 81%	0.82 UEF	
Max. Hot Water Capacity	35°F Rise: 13.2 GPM		35°F Rise: 11.1 GPM	35°F Rise: 13.2 GPM	35°F Rise: 9.8 GPM	
Water Inlet	1"	3/4"	3/4"	1"	3/4"	3/4"
Hot Water Outlet	1"	3/4"	3/4"	1"	3/4"	3/4"
Gas Inlet (1/2 in. capable)	3/4"	3/4"	3/4"	3/4"	3/4"	3/4"
Temp. Settings	100-150°F (In 5°F Intervals), 160, 170, 185° F			100-150°F (In 5°F Intervals), 160, 170, 180°F	100-150°F (In 5° F Intervals), 160, 170, 185° F	
Default Temp. Option	N/A			120, 130, 140, 180°F	120, 130, 140, 185°F	
Warranty	5 year warranty on heat exchanger, 5-year warranty on parts & 1-year reasonable labor*		10 year warranty on heat exchanger , 5 year warranty on parts & 1 year reasonable labor*	5 year warranty on heat exchanger, 5 year warranty on parts & 1 year reasonable labor*		
Ultra Low NOx	Yes			No	Yes	
Quick Connect	Yes					
Remote Included	Yes					
Min/Max Flowrate	0.5 GPM / 13.2 GPM		0.5 GPM / 11.1 GPM	0.7 GPM / 13.2 GPM	0.5 GPM / 9.8 GPM	
High Altitude Approved	Up to 4,500 ft.		Up to 10,000 ft.	Up to 8,000 ft.		
Wifi Compatible	Yes					
Common Vent Capable	No		Up to 6 Units	No		
Commercial Energy Star	Yes		No			
PVC	No	Yes		No		
ASME	No			Yes	No	

APPROVALS

Commercial



Add "-NG" or "-LP" to the end of the model number to specify gas type.

*Refer to our warranty terms & conditions for more details.

*Disclaimer: For units with more output than 200,000 BTUH, please check with your local boiler inspector to verify if ASME is required in your state.

























































> Temperature Rise

Temp Rise (F°)	Commercial				Residential											
	Condensing		Non-Condensing		Condensing								Non-Condensing			
	NCC300	NCC199CDV	NC380	NC199	EZ111	NRCR111	NRC111	EZ98	NRC98	NRCR92	NRC71	NRC66 NRC63-FSV	NR98	NR83	NR66	NR50
30	13.2	11.1	13.2	9.8	11.1	11.1	11.1	9.8	9.8	9.2	7.1	6.6	9.8	8.3	6.6	5.0
35	13.2	11.1	13.2	9.6	11.1	11.1	10.9	9.8	9.6	9.2	7.1	6.4	9.6	8.3	6.6	5.0
40	13.2	9.8	13.2	8.4	9.8	9.7	9.3	8.6	8.4	8	7.1	5.5	8.4	7.6	5.8	5.0
45	12.4	8.7	13.2	7.5	8.7	8.6	8.4	7.6	7.4	7.1	6.5	4.9	7.5	6.7	5.3	4.2
50	11.6	7.8	12.2	6.7	7.8	7.8	7.4	6.9	6.7	6.4	5.8	4.4	6.7	6.1	4.6	3.9
55	10.6	7.1	11.1	6.1	7.1	7.1	6.9	6.3	6.1	5.8	5.3	4.1	6.1	5.5	4.3	3.7
60	9.7	6.5	10.1	5.6	6.5	6.5	6.2	5.7	5.6	5.3	4.9	3.7	5.6	5.0	3.8	3.3
65	9.0	6.0	9.4	5.2	6.0	6	5.8	5.3	5.2	4.9	4.5	3.4	5.2	4.7	3.6	3.1
70	8.3	5.6	8.7	4.8	5.6	5.5	5.3	4.9	4.8	4.6	4.2	3.2	4.8	4.3	3.3	2.8
75	7.8	5.2	8.1	4.5	5.2	5.2	5.1	4.6	4.5	4.3	3.9	3.0	4.5	4.0	3.1	2.7
80	7.3	4.9	7.6	4.2	4.9	4.8	4.6	4.4	4.2	4	3.7	2.8	4.2	3.8	2.9	2.5
85	6.8	4.6	7.2	4.0	4.6	4.6	4.5	4.1	3.9	3.8	3.4	2.6	4.0	3.6	2.8	2.4
90	6.5	4.4	6.8	3.7	4.4	4.3	4.1	3.8	3.7	3.6	3.2	2.5	3.7	3.4	2.6	2.2
95	6.1	4.1	6.4	3.5	4.1	4.1	4.0	3.6	3.5	3.4	3.1	2.3	3.5	3.2	2.5	2.1
100	5.8	3.9	6.1	3.4	3.9	3.9	3.7	3.4	3.4	3.2	2.9	2.2	3.4	3.0	2.3	2.0

Temperature Rise - Combi Boilers

Temp Rise (F°)	Boilers	
	NRCB199	NRCB180
30	11.1	9.8
35	10.8	9.8
40	9.5	8.5
45	8.4	7.5
50	7.6	6.8
55	6.9	6.2
60	6.3	5.7
65	5.8	5.3
70	5.4	4.9
75	5.0	4.6
80	4.7	4.3
85	4.4	4.0
90	4.2	3.8
95	4.0	3.6
100	3.8	3.4

Sizing Chart

MODEL	SUMMER WATER SUPPLY (70 °F)		WINTER WATER SUPPLY (45 °F)	
				
NC380	      	5.3 SHOWERS AT 13.2 GPM	   	4.2 SHOWERS AT 10.4 GPM
NCC300	      	5.3 SHOWERS AT 13.2 GPM	   	3.5 SHOWERS AT 8.75 GPM
NRCR111, NRC111, NCC199, EZ111, NRCB199	    	4.1 SHOWERS AT 10.6 GPM	  	2.5 SHOWERS AT 6.2 GPM
NRC98, NR98, NC199, EZ98, NRCB180	   	3.7 SHOWERS AT 9.2 GPM	 	2.2 SHOWERS AT 5.6 GPM
NR83	   	3.3 SHOWERS AT 8.1 GPM	 	2.0 SHOWERS AT 5.0 GPM
NRCR92, NRC71	  	3.1 SHOWERS AT 7.8 GPM	 	2.0 SHOWERS AT 4.8 GPM
NR66, EZTR40	  	2.6 SHOWERS AT 6.6 GPM	 	1.5 SHOWERS AT 3.8 GPM
NR50	 	2.0 SHOWERS AT 5.0 GPM		1 SHOWER AT 3.3 GPM

Venting Type

	Residential Models											Commercial Models				
	NR83	NR98	NRC66	NRC71	NRC98	NRC111	EZTR40	EZ98 EZ111	NRCB	NRCR	NCC199	NC199	NCC300	NC380		
	DVC	DVC	SV	DV	DV	DV	DV	SVF	DV	DV	DV	CDV	DVC	DV	SV	
4" CAT III Vent			✓													
5" CAT III Vent														✓	✓	
Concentric SS Vent	✓	✓											✓			
2" Flex Pipe							✓	✓		✓						
2" PVC Vent								✓	✓	✓	✓					
3" PVC Vent				✓	✓	✓	✓	✓	✓	✓	✓					
4" PVC Vent					✓	✓								✓		

Length (including fittings)

Pipe Size	10'	20'	30'	40'	50'	60'	70'	80'	90'	100'	125'
	3m	6m	9m	12m	15m	18m	21m	24m	27m	30m	38m
3/4"	360	247	199	170	151	137	126	117	110	104	92
1"	678	466	374	320	284	257	237	220	207	195	173
1 1/4"	1,390	957	768	657	583	528	486	452	424	400	355
1 1/2"	2,090	1,430	1,150	985	873	791	728	677	635	600	532
2"	4,020	2,760	2,220	1,900	1,680	1,520	1,400	1,300	1,220	1,160	1,020
2 1/2"	6,400	4,400	3,530	3,020	2,680	2,430	2,230	2,080	1,950	1,840	1,630
3"	11,300	7,780	6,250	5,350	4,740	4,290	3,950	3,670	3,450	3,260	2,890
4"	23,100	15,900	12,700	10,900	9,660	8,760	8,050	7,490	7,030	6,640	5,890

Table 1

For less than 8" WC initial supply pressure

Maximum natural gas delivery capacity (0.5" Pressure Drop) [Schedule 40 Metallic Pipe]

Values in Table are in Cubic Feet of Gas per Hour (0.60 Specific Gravity, 0.5" Pressure Drop, inlet pressure less than 2 psi). Contact your gas supplier for BTU/Cubic Foot ratings. For simplification of your calculations, 1 Cubic Foot of Gas is approximately equivalent to 1000 BTU.

Length (including fittings)

Pipe Size	10'	20'	30'	40'	50'	60'	70'	80'	90'	100'	125'
	3m	6m	9m	12m	15m	18m	21m	24m	27m	30m	38m
1/2"	454	312	250	214	190	172	158	147	138	131	116
3/4"	949	652	524	448	397	360	331	308	289	273	242
1"	1,787	1,228	986	844	748	678	624	580	544	514	456
1 1/4"	3,669	2,552	2,025	1,733	1,536	1,392	1,280	1,191	1,118	1,056	936
1 1/2"	5,497	3,778	3,034	2,597	2,302	2,085	1,919	1,785	1,675	1,582	1,402
2"	10,588	7,277	5,844	5,001	4,433	4,016	3,695	3,437	3,225	3,046	2,700
2 1/2"	16,875	11,598	9,314	7,971	7,065	6,401	5,889	5,479	5,140	4,856	4,303
3"	29,832	20,503	16,465	14,092	12,489	11,316	10,411	9,865	9,087	8,584	7,608
4"	43,678	30,020	24,107	20,632	18,286	16,569	15,243	14,181	13,305	12,568	11,139

Table 2

For 8" WC - 10.5" WC initial supply pressure
Maximum natural gas delivery capacity (3.0" Pressure Drop)

Values in Table are in Cubic Feet of Gas per Hour (0.60 Specific Gravity, 3.0" Pressure Drop, 8.0" WC or greater supply pressure, inlet pressure less than 2 psi). Contact your gas supplier for BTU / Cubic Foot ratings. For simplification of your calculations, 1 Cubic Foot of Gas is approximately equivalent to 1000 BTU

Length (including fittings)

Pipe Size	10'	20'	30'	40'	50'	60'	80'	100'	125'	150'	175'	200'
	3m	6m	9m	12m	15m	18m	24m	30m	38m	45m	53m	60m
1/2"	291	200	160	137	122	110	101	94	89	84	74	67
3/4"	608	418	336	287	255	231	212	197	185	175	155	140
1"	1,150	787	632	541	480	434	400	372	349	330	292	265
1 1/4"	2,350	1,620	1,300	1,110	985	892	821	763	716	677	600	543
1 1/2"	3,520	2,420	1,940	1,660	1,480	1,340	1,230	1,140	1,070	1,010	899	814
2"	6,790	4,660	3,750	3,210	2,840	2,570	2,370	2,200	2,070	1,950	1,730	1,570

Table 3

Maximum Undiluted Propane (LP) Delivery Capacity in Thousands of BtuH (0.5" WC Pressure Drop) [Schedule 40 Metallic Pipe]

For reference only. Please consult gas pipe manufacturer for actual pipe capacities.



WLB

Wireless On-Demand Button kit

Model Number	Description	Qty.
WLB	Wireless Push Button kit. Includes 1 receiver and 2 transmitters	1

WLB-MS

Wireless Motion Sensor



1 x Wireless Motion Sensor

Model Number	Description	Qty.
WLB-MS	Wireless Motion Sensor (WLB Required; Sold Separately)	1



RPK-EXT

External Recirculation Pump

Model Number	Description	Qty.
RPK-EXT	External recirculation pump kit with remote ² (condensing/non-condensing) ¹	1

¹Applicable Models (both LP and NG):

NR83DVC, NR98DVC, NR98SV, NRC98DV, NRC-111DV, EZ98DV, EZ111DV, EZTR50, EZTR75

Outdoor Models (kit must be installed INDOORS only):

NR83OD, NR98OD, NRC98OD, NRC111OD, EZ98DV/EZ111DV (with Outdoor Vent Cap)

²Includes External Remote for daily pump scheduling



SS

Scale Shield Water Treatment

Model Number	Description	Qty.
SS-HB-3	Water treatment for all residential models and combi models w/ 1 unit	1
HBC-3	Replacement cartridge for SS-HB-3	1

WLB-ET

Extra Transmitter for WLB



1 x Transmitter

Model Number	Description	Qty.
WLB-ET	Additional transmitter for WLB on-demand button kit. (WLB Required; Sold Separately)	1

IK-WV-200-3-SW-LF
IK-WV-200-3-TH-LF



ALSO AVAILABLE



IK-WV

Isolator Valve Kit

Model Number	Description	Qty.
IK-WV-200-3-SW-LF	Lead free 3/4" sweat iso valve kit w/ male 500K Btuh pressure relief valve	1
IK-WV-200-3-TH-LF	Lead free 3/4" threaded iso valve kit w/ male 500K Btuh pressure relief valve	1
IK-WV-300-1-SW-LF	Lead Free 1" sweat iso valve kit with male 500K Btuh Pressure Relief Valve for NC380 & NCC300	1
IK-WV-300-1-TH-LF	Lead Free 1" threaded iso valve kit with male 500K Btuh; Pressure Relief Valve for NC380 & NCC300	1



NC-1W / NT20A

Condensate Neutralizer Kit (External)

Model Number	Description	Qty.
NC-1W	Residential condensate neutralizer kit for NRC111, NRC98, NRC711, NRC66, EZTR40, EZ98, EZ111, NRCB, and NRCR	1
NT20A¹	Commercial condensate neutralizer kit for NC199, NCC199CDV, and NCC300 series	1

¹NT20A for commercial only



PC-#

Pipe Cover

Model Number	Description	Qty.
PC-1S	Pipe Cover (NRC66, NRC71, NR50, NR66)	1
PC-2S	Pipe Cover (NR98SV/OD, NR83OD)	1
PC-2S-GRY	Stone gray pipe cover for NC199OD	1
PC-3S	Pipe cover (NRC98DV/OD & NRC111DV/OD)	1
PC-4S-SUS	Stainless steel PC for NC380SV	1
PC-5S	Pipe cover for NR98DVC & NR83DVC	1
PC-5S-GRY	Stone gray pipe cover for NC199DVC	1
PC-7S	Pipe cover for NCC300 OD/DV	1
PC-10S	Pipe cover for NRRCR, EZ Series (GQ60 Models), and NCC199CDV (GQ60 Model)	1

QC-#

Quick Connect Cable



Model Number	Description	Qty.
QC-1	Quick connect cable for NC380 ¹	1
QC-2	Quick connect cable (NR83, NR98, NRC111, NRC98, NCC199, NC199, EZ98, EZ111, NCC300, NRRCR) ¹	1

¹Up to 2 units only



DSCL-KIT

Noritz Descale Kit

Model Number	Description	Qty.
DSCL-KIT	Noritz Descale Kit includes: - 5 gal. bucket w/ lid (qty 1) - Submersible pump (qty 1) - 5 ft. hoses (qty 2)	1

MR-2

Commercial Multi-Rack System



Model Number	Description	Qty.
MR-2	Commercial multi-rack system ¹	1

¹Fits 2 heaters, front and back
Refer to page 18 for complete accessories compatibility chart.

RC-#

Remote Controller

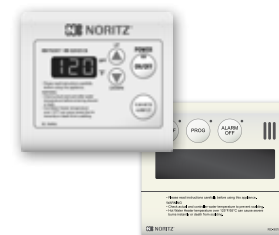

Model Number	Description	Qty.
RC-7651M	Remote controller (all residential models)	1
RC-9018M	Commercial remote controller (Excluding NC380)/ NRRCR Controller	1

Remotes will require a remote cord



RB-#
Recess Box

Model Number	Description	Qty.
RB-510	Recess box for NRC66, NR50, NR66, NRC71	1
RB-700-1	Recess box for NR98 and NR83	1
RB-900-1	Recess box for NRC111 and NRC98	1

For OD models only



RC-CORD#
Remote Controller Cord

Model Number	Description	Qty.
RC-CORD10	10 feet in length	1
RC-CORD26	26 feet in length	1



MK-NRCB-1
Manifold Kit

Model Number	Description	Qty.
MK-NRCB-1	Manifold kit for NRCB model	1



NWC-ADAPTER
Wireless Adapter

Model Number	Description	Qty.
NWC-ADAPTER	Wireless adapter (NAW-1 US) for current tankless models	1

*Not compatible with NRCB models.

Refer to page 29 for complete accessories compatibility chart.



NWCC-ADAPTER
Commercial Wireless Adapter

Model Number	Description	Qty.
NWCC-ADAPTER	Wireless adapter for current commercial tankless models	1



SC-#
System Controller

Model Number	Description	Qty.
SC-401-6M	System controller for up to 6 units for the NCC199, NCC300 & NC380 series	1
SCU-401-12M	System controller for up to 12 units for the NCC199, NCC300 & NC380 series	1
SCU-401-24M	System controller for up to 24 units for the NCC199, NCC300, & NC380 series	1
SC-401-6M-EXT	System controller for up to 6 units for the NC199	1
SC-401-6M-WIFI	System controller bundle w/ NWCC Adapter and System Controller for NCC199CDV (6 units)	1
SCU-401-12M-WIFI	System controller bundle w/ NWCC Adapter and System Controller for NCC199CDV and NCC300 (12 units)	1
SCU-401-24M-WIFI	System controller bundle w/ NWCC Adapter and System Controller for NCC199CDV (24 units)	1

Accessories Compatibility Chart

Accessories	Part #	Residential Models																		Commercial Models													
		EZ Series (GQ60)	NR50		NR66		NR83		NR98			NRC66		NRC71		NRC98		NRC111		NRCR		NRCB		EZTR40		NCC300		NCC199 (GQ60)		NC199		NC380	
			DV	OD	OD	DVC	OD	DVC	SV	OD	DV	OD	DV	OD	DV	OD	DV	OD	DV	DV	SVF	DV	OD	CDV	DVC	OD	SD						
RC Outdoor Junction Box	0700757		✓	✓					✓	✓	✓	✓	✓	✓	✓	✓								✓			✓	✓					
Universal Concentric Vent Termination Kit	PVC-UCVK	✓																		✓	✓					✓							
Low Profile Vent (2")	PVC-2LPT	✓																		✓	✓					✓							
Low Profile Vent (3")	PVC-3LPT	✓																		✓	✓					✓							
Crossover Valve Bypass Kit	CSV-BPK																			✓													
Crossover Valve	cCS-V																			✓													
Lead-Free Isolation Valve Kit	IK-WV-200-3-SW-LF	✓	✓	✓	✓	✓	✓	✓	✓	✓	✓	✓	✓	✓	✓	✓	✓	✓	✓	✓	✓	✓	✓	✓		✓	✓	✓					
	IK-WV-200-3-TH-LF	✓	✓	✓	✓	✓	✓	✓	✓	✓	✓	✓	✓	✓	✓	✓	✓	✓	✓	✓	✓	✓	✓	✓		✓	✓	✓					
	IK-WV-300-1-SW-LF																								✓						✓		
	IK-WV-300-1-TH-LF																								✓						✓		
Multi-Rack System	MR-2						✓	✓	✓						✓	✓	✓	✓						✓	✓	✓	✓	✓	✓	✓	✓		
Condensate Neutralizer Kit	NC-1W	✓									✓	✓	✓	✓	✓	✓	✓	✓	✓	✓	✓	✓	✓	✓	✓	✓	✓	✓	✓	✓	✓		
	NT20A																							✓	✓	✓							
Pipe Cover	PC-1S		✓	✓							✓	✓	✓	✓																			
	PC-2S					✓			✓	✓																							
	PC-2S-GRY																														✓		
	PC-3S													✓	✓	✓	✓																
	PC-4S-SUS																														✓		
	PC-5S				✓		✓																										
	PC-5S-GRY																										✓						
	PC-7S																								✓	✓							
	PC-10S	✓																			✓						✓						
Quick Connect Cable	QC-1																														✓		
	QC-2	✓			✓	✓	✓	✓	✓					✓	✓	✓	✓	✓	✓	✓	✓	✓	✓	✓		✓	✓	✓	✓	✓	✓		
Recess Box	RB-510		✓	✓								✓		✓																			
	RB-700-1					✓				✓																				✓			
	RB-900-1																																
Remote Controller	RC-7651M	✓	✓	✓	✓	✓	✓ ¹	✓ ¹	✓ ¹	✓	✓	✓	✓	✓ ¹	✓ ¹	✓ ¹	✓ ¹	✓													✓ ¹		
	RC-9018M	✓																			✓				✓	✓	✓	✓ ¹	✓ ¹				
Remote Controller Cord	RC-CORD10	✓	✓	✓		✓		✓ ¹	✓ ¹	✓	✓	✓	✓	✓	✓ ¹	✓ ¹	✓ ¹	✓ ¹						✓	✓	✓	✓	✓ ¹	✓ ¹	✓	✓		
	RC-CORD26	✓	✓	✓		✓		✓	✓	✓	✓	✓	✓	✓	✓	✓	✓	✓						✓	✓	✓	✓	✓	✓	✓	✓		
System Controller	SC-401-6M-EXT																											✓	✓				
	SCU-401-24M																								✓	✓	✓				✓		
	SCU-401-12M																								✓	✓	✓				✓		
	SC-401-6M																								✓	✓	✓				✓		
	SC-401-6M-WIFI																								✓	✓	✓						
	SCU-401-12M-WIFI																								✓	✓	✓						
Building Management System	BMS1-SC-401-6M																							✓	✓	✓	✓	✓	✓	✓			
EZTR Optional Diffuser Kit	EZ2-DK	✓																		✓						✓							
Manifold Kit	MK-NRCB-1																														✓		
Wireless Push Button Kit	WLB																														✓		
Motion Sensor	WLB-MS																														✓		
Extra Transmitter for WLB	WLB-ET																														✓		
Scale Shield Water Treatment	SS-HB-3	✓	✓	✓	✓	✓	✓	✓	✓	✓	✓	✓	✓	✓	✓	✓	✓	✓	✓	✓	✓	✓	✓	✓	✓	✓	✓	✓	✓	✓	✓		
Replacement Cartridge for SS-HB-3	HBC-3	✓	✓	✓	✓	✓	✓	✓	✓	✓	✓	✓	✓	✓	✓	✓	✓	✓	✓	✓	✓	✓	✓	✓	✓	✓	✓	✓	✓	✓	✓		
2" SV Conversion Kit	SV-CK-2-1	✓																													✓		
3" SV Conversion Kit	SV-CK-3-1																														✓		
Wireless Adapter	NWC-ADAPTER	✓	✓	✓	✓	✓	✓	✓	✓	✓	✓	✓	✓	✓	✓	✓	✓	✓	✓							✓	✓	✓	✓	✓	✓		

¹Included w/ heater purchase
²Two units required

³Must be installed indoors
⁴Only for EZ Series and NRCB

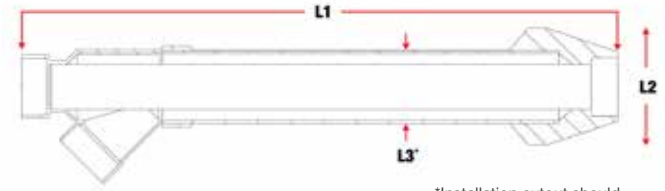

*Installation cutout should be at least 1/2" larger than dimension L3

PVC-#CT

PVC Concentric horizontal termination kit

Model Number	Description	L1	L2	L3	Qty.
PVC-2CT	2" PVC Concentric Termination	41"	7.38"	3.5"	1
PVC-3CT	3" PVC Concentric Termination	48"	8.75"	4.5"	1

DIAGRAM:
Horizontal Configuration

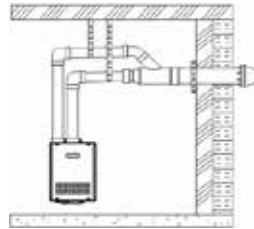
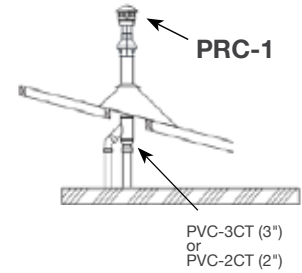

DIAGRAM:
Vertical Configuration



PVC-UCVK

Universal Concentric Vent Termination Kit

Model Number	Description	L1	L2	L3	Qty.
PVC-UCVK	Universal Concentric Vent Termination Kit	31"	20"	4.5"	1

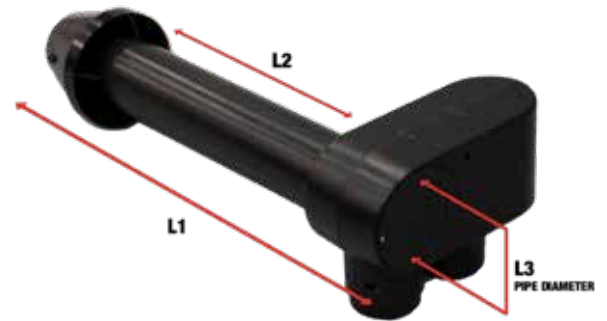

PVC-#LPT

Low Profile Vent

Model Number	Description	L1	L2	Qty.
PVC-2LPT	Low Profile Vent (2")	2.37"	2.37"	1
PVC-3LPT	Low Profile Vent (3")	3.50"	3.38"	1

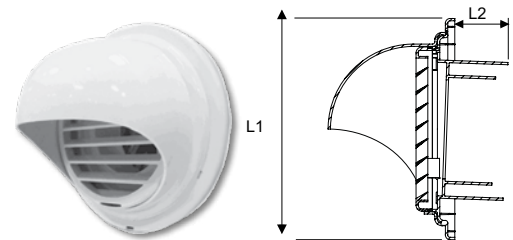

PVT-HL

Plastic Horizontal Termination

Model Number	Description	L1	L2	Qty.
PVT-HL¹	2" PVC ²	7.5"	2.0"	6
	3" PVC			
	4" PVC			

¹Not approved for Canada
²Needs 2" reducer

SV-CK-2-1

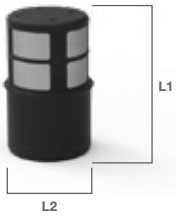

SV-CK-3-1



COMING SOON

SV-CK-#-1

2" and 3" SV Conversion Kit

Model Number	Description	L1	L2	Qty.
SV-CK-2-1	2" SV Conversion Kit	3.88"	2.37"	1
SV-CK-3-1	3" SV Conversion Kit	3.56"	3.48"	1

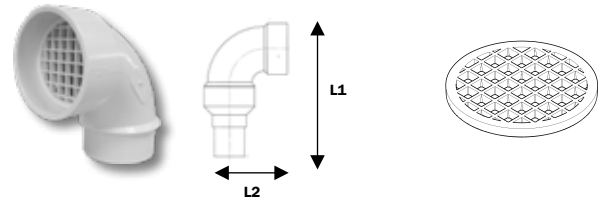

SV-CK-#

DV to SV Conversion Kit

Model Number	Description	L1	L2	Qty.
SV-CK-2	2" PVC (EZ/CDV)	10.4"	6.7"	1
SV-CK-3	3" PVC (NRC)	6.7"	6.4"	1
SV-CK-4	4" PVC (NCC300)	2.85"	2.96"	1
SV-CKM-23	2" or 3" (Screen Only)	-	-	1

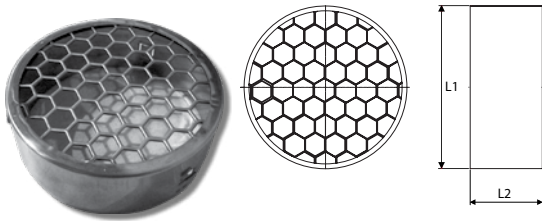

VT#-PVCS

PP or Stainless Steel Bird Screen for PVC Termination

Model Number	Description	L1	L2	Qty.
VT2-PVCS	2" Polypropylene (White)	2"	3"	6
VT3-PVCS	3" Stainless Steel	2.8"	3"	6
VT4-PVCS	4" Stainless Steel	4.5"	3"	6



PRC-1

Plastic Rain Cap

Model Number	Description	L1	L2	Qty.
PRC-1	2" (EZ98, EZ111, NCC199CDV)	7.7"	6.2"	1
	3" (For NRC111, NCC199, NRC98, NRC71, NRC66, NRCB, & NCC199CDV)			
	4" (For NRC111, NCC199, NRC98, NCC300)			



VK4-PVC2SUS

4" Adapter

Model Number	Description	Qty.
VK4-PVC2SUS	Convert from 4" for PVC to 4" single-wall stainless steel venting	1
PVC4XVP5-ADAPT	4" for PVC to 5" stainless steel vent adapter (NCC300)	1



CR#-PVC

Cosmetic Ring

Model Number	Description	Qty.
CR3-PVC	3" Cosmetic ring for PVC	1
CR4-PVC	4" Cosmetic ring for PVC	1

VP#-#STR

Rigid vent pipe stainless steel single-wall

Model Number	Venting Series	L1	L2	Qty.
VP4-6STR	4" SUS	2.1"	6"	6
VP4-12STR	4" SUS	2.1"	12"	6
VP4-24STR	4" SUS	2.1"	24"	6
VP4-36STR	4" SUS	2.1"	36"	6
VP4-48STR	4" SUS	2.1"	48"	6
VP5-6STR	5" SUS	2.7"	6"	6
VP5-12STR	5" SUS	2.7"	12"	6
VP5-24STR	5" SUS	2.7"	24"	6
VP5-36STR	5" SUS	2.7"	36"	6
VP5-48STR	5" SUS	2.7"	48"	6

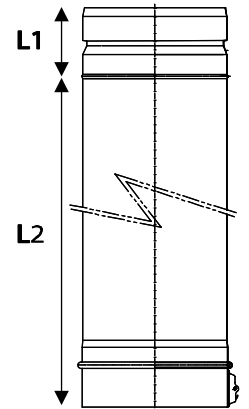

VP#-#ADJ

Adjustable vent pipe stainless steel single wall

Model Number	Venting Series	L1	L2	Qty.
VP4-9.4ADJ	4" SUS	2.1"	6.8 - 9.1"	6
VP4-13.4ADJ	4" SUS	2.1"	9.5 - 14.6"	6
VP4-21.4ADJ	4" SUS	2.1"	15.4 - 26.5"	6
VP4-60ADJ	4" SUS	2.1"	36-60"	6
VP5-9.4ADJ	5" SUS	2.7"	6.8 - 9.1"	6
VP5-13.4ADJ	5" SUS	2.7"	9.5 - 14.6"	6
VP5-21.4ADJ	5" SUS	2.7"	15.4 - 26.5"	6

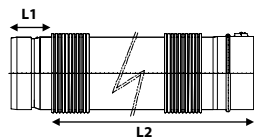
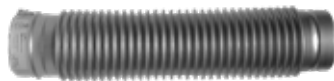
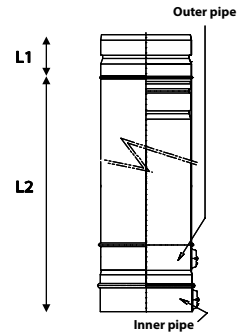

VP#-18FLEX

Semi-flexible vent pipe stainless steel single wall

Model Number	Venting Series	L1	L2	Qty.
VP4-18FLEX	4" SUS	2.1"	16.75"	6
VP5-18FLEX	5" SUS	2.1"	16.75"	6

4" SUS	For NR98SV
5" SUS	For NC380 Series
Concentric SUS	For DVC Series

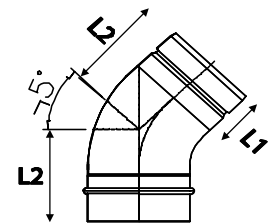

VP#-45ELB

45° Vent pipe elbow stainless steel single-wall

Model Number	Venting Series	L1	L2	Qty.
VP4-45ELB	4" SUS	2.1"	4.0"	6
VP5-45ELB	5" SUS	2.7"	5.4"	6

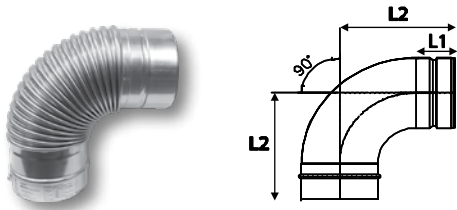

VP#-90ELB

90° Vent pipe elbow stainless steel single wall

Model Number	Venting Series	L1	L2	Qty.
VP4-90ELB	4" SUS	2.1"	6.2"	6
VP5-90ELB	5" SUS	2.7"	7.9"	6

*Non-flexible

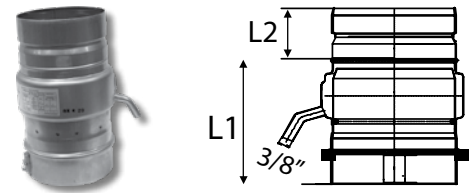

DT#-V

Vent pipe vertical drain tee stainless steel single wall

Model Number	Venting Series	L1	L2	Qty.
DT4-V	4" SUS	5.1"	2.1"	6
DT5-V	5" SUS	6.2"	2.1"	6

*Non-flexible

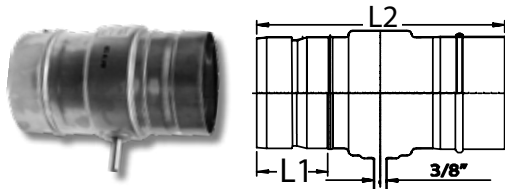

DT#

Vent pipe horizontal drain tee stainless steel single-wall

Model Number	Venting Series	L1	L2	Qty.
DT4	4" SUS	2.1"	7.2"	6
DT5	5" SUS	2.1"	8.0"	6

*Non-flexible

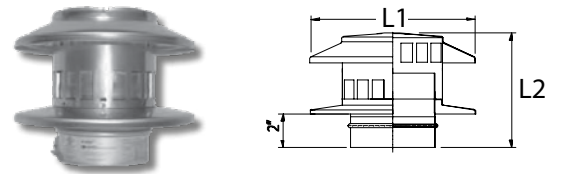

RC#

Vent pipe rain cap stainless steel single wall

Model Number	Venting Series	L1	L2	Qty.
RC4	4" SUS	7.8"	6.6"	6
RC5	5" SUS	11"	7.2"	6

*Non-flexible

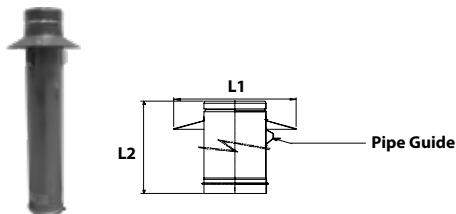

SCP5

Storm collar vent pipe stainless steel single wall

Model Number	Venting Series	L1	L2	Qty.
SCP5	5" SUS	8.8"	25.2"	6

5" SUS	For NC380 Series
Concentric SUS	For DVC Series

> Single Wall Vent Accessories

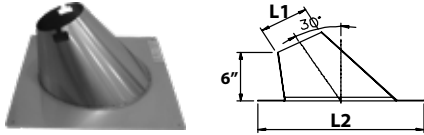

ARF#

Angled roof flashing stainless steel single-wall

Model Number	Venting Series	L1	L2	Qty.
ADJRF34 ²	4" ¹	5.7"	14.3"	1
ARF5	5" SUS	7"	18"	1
CARF-1	Concentric SUS ¹	8"	16"	1

¹Galvalume for ADJRF34

²0-45 degree roof pitch

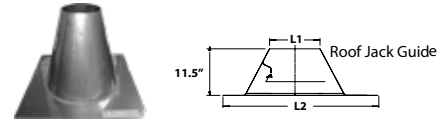

FRF5

Stainless steel flat roof flashing stainless steel single-wall

Model Number	Venting Series	L1	L2	Qty.
FRF5	5" SUS	6.3"	18"	1

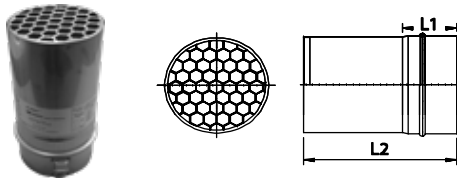

VT#-S

Straight termination w/ birdscreen stainless steel single-wall vent pipe

Model Number	Venting Series	L1	L2	Qty.
VT4-S	4" SUS	2.1"	6.2"	6
VT5-S	5" SUS	2.7"	7.9"	6

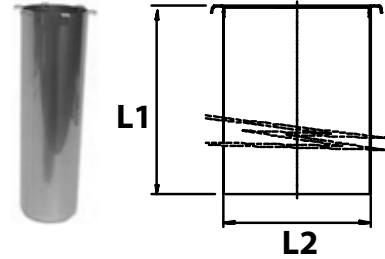

RJ#

Roof Jack

Model Number	Venting Series	L1	L2	Qty.
ADJRJ34 ¹	4"	18.2"	4.6"	6
RJ5	5" SUS	18"	6"	6

¹Galvalume for ADJRF34

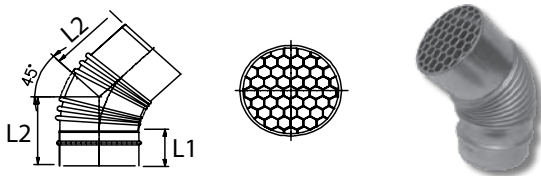

VT#-S45

45° Vent pipe termination w/ birdscreen stainless steel single-wall

Model Number	Venting Series	L1	L2	Qty.
VT4-S45	4" SUS	2.1"	4"	6
VT5-S45	5" SUS	2.7"	5.4"	6

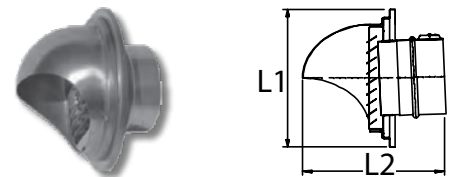

VT#-SH

Vent pipe termination w/ hood stainless steel single-wall vent pipe

Model Number	Venting Series	L1	L2	Qty.
VT4-SH	4" SUS	7.4"	6.1"	6
VT5-SH	5" SUS	7.4"	6.6"	6

4" SUS	For NR98SV
--------	------------

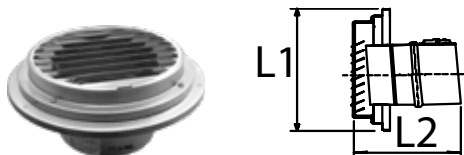

VT#-SL

Vent pipe termination w/ louver stainless steel single-wall

Model Number	Venting Series	L1	L2	Qty.
VT4-SL	4" SUS	7.4"	3.2"	6
VT5-SL	5" SUS	7.4"	3.7"	6

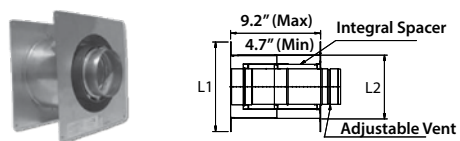

WT#

Vent pipe wall thimble stainless steel single-wall

Model Number	Venting Series	L1	L2	Qty.
WT4	4" SUS	10"	7"	1
WT5	5" SUS	12.2"	10.7"	1

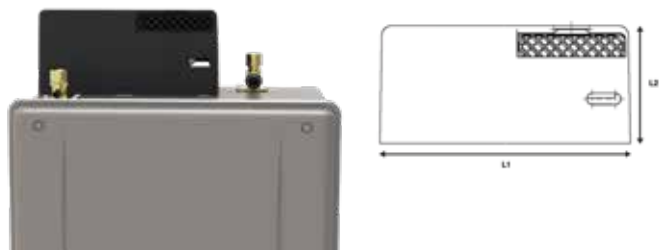

VC-#

Outdoor vent caps for SV models

Model Number	Venting Series	L1	L2	Qty.
VC-6-1	Outdoor vent cap for EZ, NRCR, and CDV models.	10.9"	5.1"	1
VCK-NRCB	Outdoor conversion kit for NRCB boiler	10.4"	5.3"	1
VC-132	Outdoor vent cap for NC380	18.9"	7.6"	1

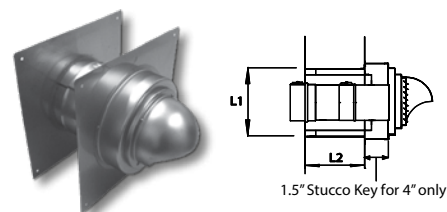

WT4-H-#

Adjustable wall thimble w/ termination stainless steel single-wall vent pipe

Model Number	Venting Series	L1	L2	Qty.
WT4-H-8-1	4" SUS	5.8"	4.1 - 7.8"	1
WT4-H-14-1	4" SUS	5.8"	7.8" - 14"	1



VP4-ADAPT-1

Appliance adapter vent pipe stainless steel single-wall

Model Number	Venting Series	L1	L2	Qty.
VP4-ADAPT1	4" SUS	1.2"	4.9"	6

*Only used with non-Noritz unit but want to use for N-Vent

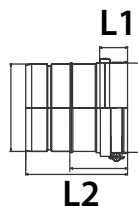

4" SUS	For NR98SV Series
--------	-------------------

> Single Wall Vent Accessories

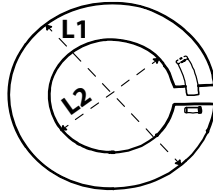

CR#

Stainless steel cosmetic ring

Model Number	Venting Series	L1	L2	Qty.
CR4-SUS	4" SUS	7.2"	4.3"	1
CR5-SUS	Concentric and 5" SUS	9.9"	5.4"	1

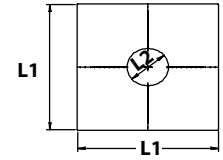

FS#

Stainless steel fire stop

Model Number	Venting Series	L1	L2	Qty.
FS4	4" SUS	18"	4.4"	6
FS5	5" SUS	20.4"	5.4"	6

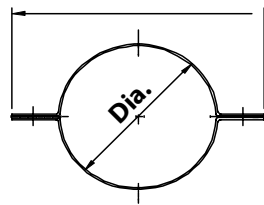

SC#

Stainless steel support clamp

Model Number	Venting Series	Dia.	L2	Qty.
SC4	4" SUS	6"	-	5 Sets
SC5	5" SUS	7"	-	5 Sets

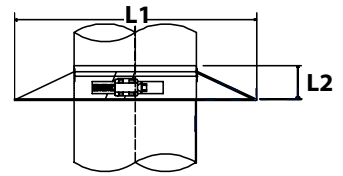

SCR#

Storm collar ring

Model Number	Venting Series	L1	L2	Qty.
SCR4-1	4"	9"	6"	1
CSCR-1	Concentric and 5" SUS	9.1"	4"	6

4" SUS	For NR98
5" SUS	For NC380 Series
Concentric SUS	For DVC Series

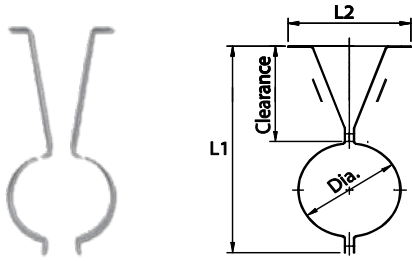

SS5-#

5" and concentric SUS venting series stainless steel support straps

Model Number	Clearance	L1	L2	Qty.
SS5-1	1"	6.8"	6"	5 Sets
SS5-2	2"	7.8"	6"	5 Sets
SS5-4	4"	9.8"	6"	5 Sets
SS5-6	6"	11.8"	6"	5 Sets

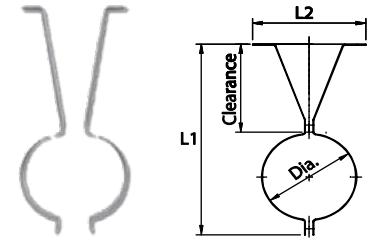

SS4-#

4" SUS venting series stainless steel support straps

Model Number	Clearance	L1	L2	Qty.
SS4-1	1"	5.7"	4.7"	5 Sets
SS4-2	2"	6.6"	4.7"	5 Sets
SS4-4	4"	8.7"	4.7"	5 Sets
SS4-6	6"	10.7"	4.7"	5 Sets



BG-DVC-#

Stainless steel bug guard

Model Number	Venting Series	Description	Qty.
BG-DVC-H	Concentric SUS	Horizontal	1
BG-DVC-V	Concentric SUS	Vertical	1

Image and drawing shown: BG-DVC-V



FP-5-OUT

Stainless steel face plates

Model Number	Venting Series	L1	L2	Qty.
FP-5-OUT	Concentric SUS	6.7"	8.7"	1

4" SUS	For NR98
5" SUS	For NC380 Series
Concentric SUS	For DVC Series

VK4-V1

Vent Pipe Vertical Kit (Stainless steel single wall)

Model Number	Venting Series	Qty.
VK4-V1	4" SUS	1

N-Vent Vertical Vent Kit VK4-V1

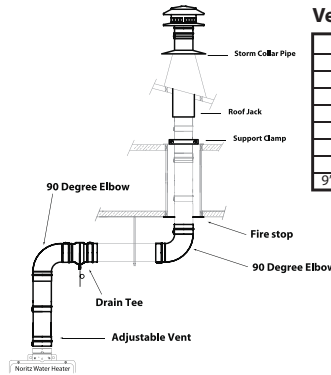

Vertical Kit Contains:

Description	Part Number	Quantity
Drain Tee	DT4	1
90 Degree Elbow	VP4-90ELB	2
Firestop	FS4	1
Support Clamp	SC4	1
Roof Jack	RJ4	1
Storm Collar Pipe	SCP4	1
Rain Cap	RC4	1
9"- 13.4" Adjustable Vent	VP4-13.4ADJ	1



VK4-H-#-1

Vent Pipe Horizontal Kit (Stainless steel single wall)

Model Number	Venting Series	Qty.
VK4-H-8-1	4" SUS ¹	1
VK4-H-14-1	4" SUS ²	1

N-Vent Horizontal Vent Kit VK4-H-*

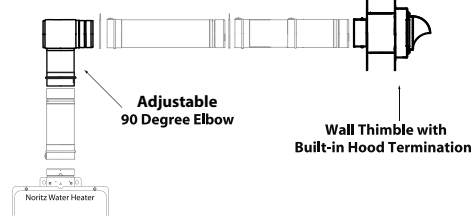

Horizontal Kit Contains:

Description	Part Number	Quantity
Wall Thimble with Built-in Hood Termination	WT4-H-#-1 (# Based on wall thickness)	1
Vertical Adjustment Range (7.5" - 11")	VP4-90ADJELB	1

Wall Thickness	Venting Kit Number
4.1" - 7.4"	VK4-H-8-1
7.4" - 14"	VK4-H-14-1



¹ 4.1 - 7.4" Wall thickness

² 7.4 - 14" Wall thickness

4" SUS	For NR98SV
5" SUS	For NC380 Series
Concentric SUS	For DVC Series

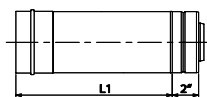

CVP-#STR

Rigid vent pipe stainless steel double-wall

Model Number	Venting Series	L1	L2	Qty.
CVP-4STR	Concentric SUS	3.3"	-	5 Sets
CVP-12STR	Concentric SUS	11.8"	-	5 Sets
CVP-24STR	Concentric SUS	23.6"	-	5 Sets
CVP-36STR	Concentric SUS	35.4"	-	5 Sets

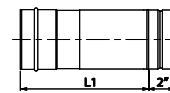

CVP-#ADJ

Adjustable vent pipe stainless steel double-wall

Model Number	Venting Series	L1	L2	Qty.
CVP-11ADJ	Concentric SUS	8.3 - 11.2"	-	6
CVP-16ADJ	Concentric SUS	11 - 16.7"	-	6
CVP-40ADJ	Concentric SUS	22.8 - 40.6"	-	6

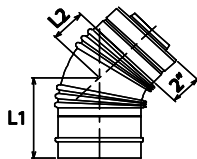

CVP-45ELB

45° Vent pipe elbow - Stainless steel double-wall

Model Number	Venting Series	L1	L2	Qty.
CVP-45ELB¹	Concentric SUS	5.3"	2.2"	6

¹ Non-Flexible

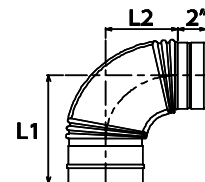

CVP-90ELB

90° Vent pipe elbow - Stainless steel double-wall

Model Number	Venting Series	L1	L2	Qty.
CVP-90ELB¹	Concentric SUS	8.1"	4.9"	6

¹ Non-Flexible

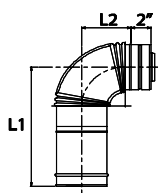

CVP-90ADJELB

90° Adjustable vent pipe elbow - Stainless steel double-wall

Model Number	Venting Series	L1	L2	Qty.
CVP-90ADJELB	Concentric SUS	12.6 - 15.8"	4.9"	6

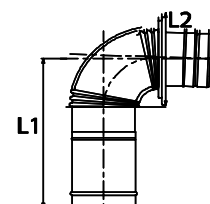

CWF-90ELB

90° Adjustable vent pipe elbow w/ wall flange - Stainless steel double-wall

Model Number	Venting Series	L1	L2	Qty.
CWF-90ELB	Concentric SUS	12.6 - 15.8"	8.7"	6

Concentric SUS	For DVC Series
----------------	----------------

> DVC Vent Kits

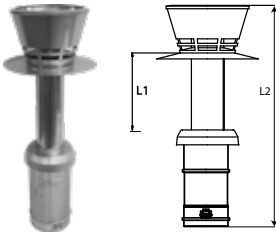

CRCAI-1-F

Vent pipe rain cap - Stainless steel double-wall

Model Number	Venting Series	L1	L2	Qty.
CRCAI-1-F	Concentric SUS	10.6"	26.5"	1

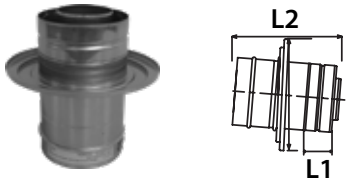

CWF-F

Vent pipe w/ wall flange - Stainless steel double-wall

Model Number	Venting Series	L1	L2	Qty.
CWF-F	Concentric SUS	2"	8.7"	6



CVP-ADAPT-M2M

Concentric vent pipe male to male - stainless steel double-wall

Model Number	Venting Series	L1	L2	Qty.
CVP-ADAPT-M2M	Concentric	5"	5.5"	1

Newest heater models. Version 1 venting.

Note the venting has changed. Before installation, confirm the termination piece ordered on the table below. If a vent termination piece from the "Existing Vent Kit" column is being utilized, a CVP-ADAPT-M2M (Fig 1) adapter must be utilized. If a vent termination from the "New Vent Kit" column is utilized, no adapter is necessary.

	EXISTING VENT KIT	NEW VENT KIT
HORIZONTAL	CVK-H CVK-H2 CWF	CVK-H-F CVK-H2-F CWF-F
VERTICAL	CRCAI-1 CVK-V-1	CRCAI-1-F CVK-V-1-F



CVP-ADAPT-F2F

Concentric vent pipe adapter female to female - stainless steel double-wall

Model Number	Venting Series	L1	L2	Qty.
CVP-ADAPT-F2F	Concentric	5"	7.5"	1

Prior heater models. Version 2 venting.

Concentric SUS	For DVC Series
----------------	----------------

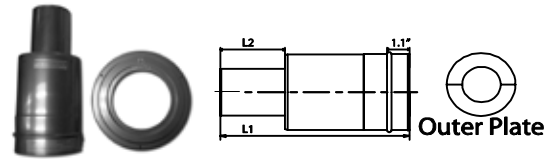

CVT-S

Straight termination w/ birdscreen - Stainless steel double-wall vent pipe

Model Number	Venting Series	L1	L2	Qty.
CVT-S	Concentric SUS	11"	3.9"	6



CWT-H

Builder's edition wall thimble - Galvalume double-wall vent pipe

Model Number	Venting Series	L1	L2	Qty.
CWT-H	Concentric	Min 3.5"	1.5"	1

HORIZONTAL INSTALLATIONS

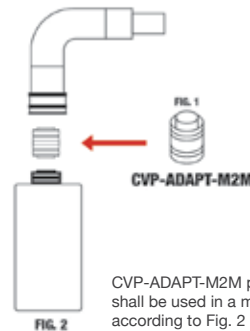

CVP-ADAPT-M2M piece shall be used in a manner according to Fig. 2

VERTICAL INSTALLATIONS

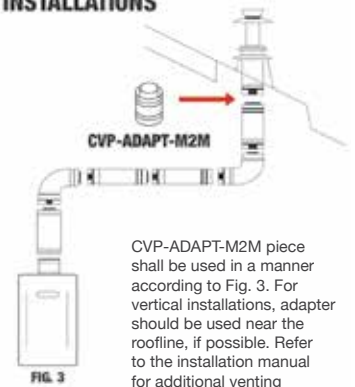

CVP-ADAPT-M2M piece shall be used in a manner according to Fig. 3. For vertical installations, adapter should be used near the roofline, if possible. Refer to the installation manual for additional venting instructions.

HORIZONTAL INSTALLATIONS

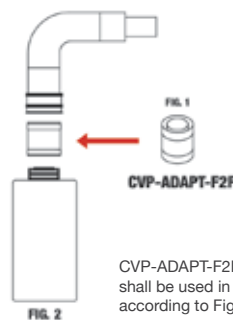

CVP-ADAPT-F2F piece shall be used in a manner according to Fig. 2

VERTICAL INSTALLATIONS

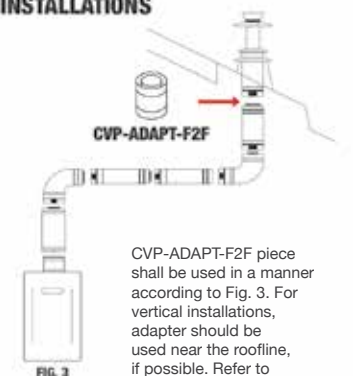

CVP-ADAPT-F2F piece shall be used in a manner according to Fig. 3. For vertical installations, adapter should be used near the roofline, if possible. Refer to the installation manual for additional venting instructions.

Horizontal - Kits

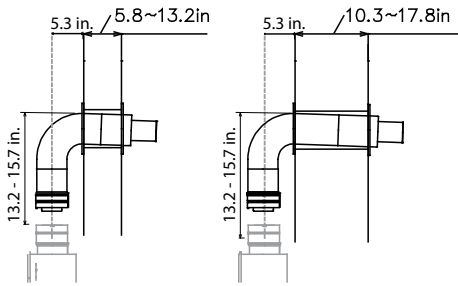

Standard Wall Kit
Includes inner & outer plates
CVK-H-F
Wall Thickness Range
From 5.8"-13.2"

Thick Wall Kit
Includes inner & outer plates
CVK-H2-F
Wall Thickness Range
From 10.3"-17.8"



Horizontal - Build your own

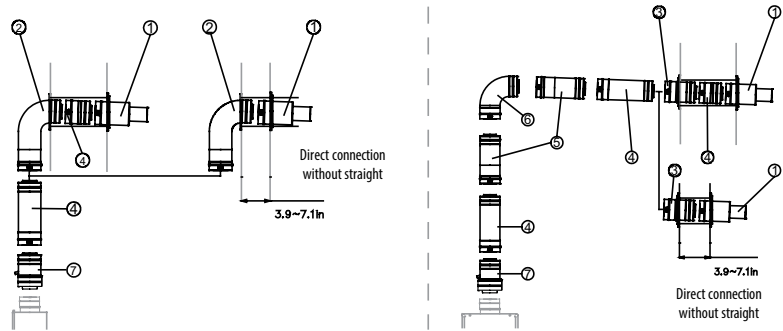

No	1	2	3	4	5	6	7
Description	Straight Bird Screen w/ Outer Plate	90° Adj w/ Wall Flange	Straight Vent Pipe w/ Wall Flange	Straight	Adjustable	45/ 90 Degree	Drain Tee
Part Number	CVT-S	CWF-90ELB	CWF-F	CVP-4/12/24/36STR	CVP-11/16/40ADJ	CVP-45/90ELB	CDT-V

CVK-H-F

Vent pipe horizontal kit - Stainless steel double-wall

Model Number	Venting Series	Qty.
CVK-H-F	Concentric SUS ¹	1
CVK-H2-F	Concentric SUS ²	1

¹ (5.8 - 13.2" Wall thickness)
² (10.3 - 17.8" Wall thickness)

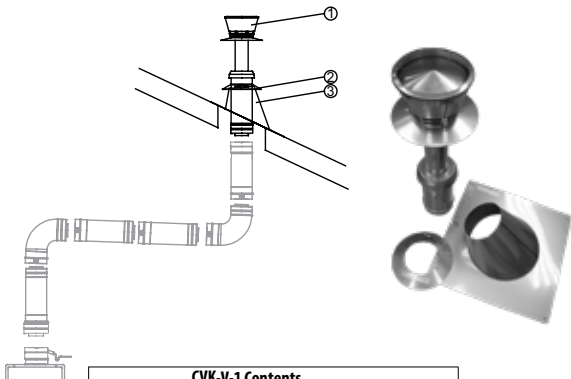

CVK-V-1 Contents		
No	Description	Part Number
1	Concentric Rain Cap	CRCAL-1-F
2	Storm Collar	CSCR-1
3	Adjustable Roof Flashing (0-45 Degrees)	CARF-1



Snorkel Kit

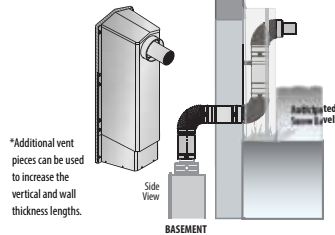

*Additional vent pieces can be used to increase the vertical and wall thickness lengths.

Snorkel Kit (CVK-SNRK) Contents		
PCS	Description	Part #
1	Snorkel case top	SNRK-C1
2	Snorkel case bottom	SNRK-C2
3	Concentric 11" adjustable vent pipe	CVP-11ADJ
4	Concentric 16" adjustable vent pipe	CVP-16ADJ
5	Concentric snorkel termination elbow	CVP-SNRK-90ELB
6	Concentric 90 degree elbow	CVP-90ELB
7	Concentric 90 degree adjustable elbow	CVP-90ADJELB
8	Adjustable support strap	SSS-3ADJ
9	Screw set	S-12
10	Concentric vent pipe, male to male	CVP-ADAPT-M2M



CVK-V-1-F

Vent pipe vertical kit - Stainless steel double-wall

Model Number	Venting Series	Qty.
CVK-V-1-F	Concentric SUS ¹	1

CVK-SNRK-F

Vent pipe horizontal snorkel kit - Stainless steel double-wall

Model Number	Venting Series	Qty.
CVK-SNRK-F	Concentric SUS	1

¹0-45° Roof Pitch



Newly Updated

SUPPORT SITE & PARTS ORDERING

GET CERTIFIED PARTS FOR ANY NORITZ REPAIR. PERIOD.

Our newly redesigned support page is your go-to source for all technical specs and support documents for all Noritz tankless water heaters.

One of the biggest updates we're excited to share is the addition of parts ordering online! Find all the parts you need, available 24/7 to order. Stock your truck with all those necessary parts today!

Visit [SUPPORT.NORITZ.COM](https://support.noritz.com)

FEATURES



NEW Parts Ordering Online

Get the parts you need 24/7. Our new parts ordering feature saves time and minimizes waiting when you need it most. Keep your parts stocked and ready for any scenario.



Technical Literature

Our technical literature page offers owners a vast library of documents for each heater including spec sheets, owner's guides, install manuals, parts lists, and certification documents.



Part Search Tool

Allows you to search for parts easily. Access a complete overview of technical spec info, installation, accessories, approvals, & warranty.



Warranty Calculator

This calculator is designed to approximate the length of your warranty terms. Now more precise when you add an installation date or maintenance monitor data.



NORITZ[®] UNIVERSITY

HONE YOUR CRAFT.

Noritz prides itself in providing our installers all the tools necessary to make every install a great one. Noritz University provides a library of resources available online, along with live virtual events on a number of products and topics every week.

In addition, Noritz online training courses are available to everyone who wants to learn more about the ins and outs of our tankless water heaters at their own pace. From domestic units to combination boilers, our courses are designed to deepen your knowledge of Noritz tankless technology.

Available Online Courses Include:

- *R1 training*
- *Noritz tankless models with pump*
- *EZTR bundles*
- *Combination boilers*

Get started today at [Training.Noritz.com](https://training.noritz.com)



Noritz is excited to introduce ProCard+! Available as an upgrade to our existing ProCard, this new subscription-based program brings you even more qualified leads as well as tools to expand your business with Noritz, the industry's most trusted line of tankless water heaters.

Get More Leads

With ProCard+, installers receive even more qualified leads, thanks to our new and improved lead retrieval system.



Business Profile +

ProCard+ users enjoy access to our Business Profile Plus, a customizable profile page with additional pictures, reviews and business information.



Custom Prequalifying Questions

Gain quick access to customer information with customizable questionnaires and photo submissions.



Rise to the Top

Our ProCard+ users automatically place higher in our 'Find an Installer' page, giving your business more leads in your area.



TAKE YOUR BUSINESS TO THE NEXT LEVEL

ProCard+ brings even more benefits to contractors looking to expand their business and service even more customers in their area.

	PROCARD	PROCARD +
Get Listed on our Contractor Finder	✓	✓
Register Warranties	✓	✓
Get Leads	✓	✓
Advanced Business Profile	-	✓
Higher Ranking on Contractor Finder	-	✓
Improved Lead Retrieval System	-	✓
Customize Prequalifying Questions for Customers	-	✓

To register or to get more information about our ProCard+ program, email us at ProPlus@Noritz.com



TRAILBLAZERS IN THE FIELD OF TANKLESS WATER HEATING

Noritz is on the forefront of the tankless industry by pushing the limits of our technology to develop the most reliable and efficient products on the market. Combined with our world-class customer service, Noritz is the first choice in tankless water heating, giving installers peace of mind when choosing a tank replacement.

Noritz America | www.Noritz.com



11160 Grace Avenue
Fountain Valley, CA 92708

Phone:
1-866-766-7489

Tech Support Hours:
Monday - Friday
5am - 6pm PST
Sat-Sun
7am - 4pm PST

Fax:
(714) 241-1514



Follow us on social media
@NORITZAMERICA

01/22