



 **NORITZ**[®]
TANKLESS WATER HEATERS

2024

PRODUCT GUIDE



EZ SERIES
25
YEAR
WARRANTY

Table of Contents

Noritz Flagship Products

4 Featured Product: Hybrid Hot

6 NRCR

10 EZ Series

14 EZTR Bundles

16 NRCB

18 NCC199CDV

20 Commercial Rack Systems

Technical Specs

22 High Efficiency Models

24 Mid Efficiency / Commercial Models

26 Temperature Rise / Gas Sizing Charts

Accessories

28 Accessory Compatibility Chart

29 Accessories

32 PVC Vent Accessories

34 Single Wall Vent / Single Wall Vent Accessories

38 Single Vent

39 Concentric Vent

41 Concentric Vent Kits

Installer Programs and Support

42 New Noritz Support Site / Noritz University

43 ProCard +



Did you know?

Noritz began in 1951 as Noritsu Bath Industry in Motomachi, Kobe

Over 50 years in the field of tankless water heating

Noritz has been an innovator in the water heating industry for over 70 years. We introduced the first modern, electronically controlled tankless water heaters in 1981 and we remain the leader in energy savings and superior hot water delivery today.

Serving both homeowners & commercial users across the U.S. and Canada, Noritz America offers a broad range of tankless gas water heaters to meet the varying needs of its broad spectrum of customers.





HH

HYBRID HOT SERIES

BY NORITZ®

Our latest innovation... The First Tankless and Tank Combo from Noritz

Endless Hot Water. Quicker Recovery.

The NEW Hybrid Hot Series by Noritz® brings together the storage of a standard tank with the power and efficiency of a tankless to take on any commercial hot water demand.

Combined to meet the hot water requirements of businesses, the Hybrid Hot Series by Noritz® utilizes the latest in tankless and tank storage technologies to create a powerful and reliable solution for business owners. The Hybrid Hot also offers common venting for multiple units to ensure endless hot water is always available.

Noritz is proud to present our latest innovation in tankless technology.



Scan to watch our
**Hybrid Hot
3D Explainer Video**

Performance

Approved Gas Types	Natural Gas or Propane
Efficiency	0.96 UEF 98% Thermal Efficiency
First Hour Rating	317 GPH

Recovery Capacity

Product Number	Approx. Tank Capacity	Max Input (Btu/hr)	GPH (LPH) vs Temperature Rise											
			30°F	40°F	50°F	60°F	70°F	80°F	90°F	100°F	110°F	120°F	130°F	140°F
NHH199100	119 Gal	199,900	780	585	468	390	334	292	260	234	213	195	180	167

Technical Specs

Hybrid Hot Series by Noritz®		
Product Number		NHH199100-1-NG
		NHH199100-1-LP
Installation Location		Indoor
Working Pressure	Water	15 - 150 psi
	Gas	NG: 3.5 - 10.5" LP: 8.0 - 14.0"
Connection Size	Cold Water	NPT 1-1/2"
	Hot Water	NPT 1-1/2"
	Return (Recirc)	NPT 3/4"
	Gas	NPT 3/4"
Vent	Type	DV / SV
	Size	2" / 3"
	Max Length	2": 65' / 3": 150'
	Common Vent	Yes (Up to 6 Units)
Dimensions		H: 67 3/4" W: 28" D: 43.5"
Weight		544 lbs.
Power Supply		120 VAC (60Hz)
Tank Capacity		119 Gallons (Cement Lined)
Tankless Capacity		18,000 - 199,900 BTU/h
Temperature Setting		100 - 185°F (37 - 85° C)



Features

The Best of Tank and Tankless

With an endless supply of hot water, lower pressure drop, and no limitation of hot water flow rate, the Hybrid Hot Series by Noritz® combines features of both technologies to provide the most reliable hot water delivery system to date for commercial applications.

Faster Hot Water Recovery

The Hybrid Hot offers the best BTU possible at the quickest rate, providing businesses with energy savings and more. Thanks to its larger pump, hot water recovery speed with the Hybrid Hot is faster than other tank and tankless combinations.

Cement Lining

With no anode rod and a greater warranty than other tanks on the market, our tank also features cement lining for superior corrosion resistance.

Continuous Hot Water Delivery

If your tank suddenly runs out of hot water, no need to worry. The Hybrid Hot Series by Noritz® can continue to provide hot water using the paired NCC199CDV tankless even after your stored supply is depleted*.

*Hot water capabilities are limited

10 Year Tank + Tankless Warranty

The Hybrid Hot Series by Noritz offers an industry leading 10 year warranty for both the tank and tankless, bringing peace of mind to business owners.

NCC199CDV - TRUE Commercial Tankless

The included Noritz NCC199CDV commercial tankless provides industry leading performance for any commercial water heating application and features high grade heat exchangers, common venting capability, and a high efficiency.

Recirculation Reinvented

NRCR

NORITZ RESIDENTIAL CONDENSING RECIRCULATION

The Noritz NRCR series offers the latest cutting edge recirculation technology in a tankless water heater. This unit is equipped with high quality stainless steel heat exchangers for extreme corrosion and thermal stress resistance, giving your tankless a longer lifespan. In addition, a recirculation pump comes integrated with the unit to give you hot water faster and without the wait.



Integrated Recirculation Pump

The NRCR Residential Condensing Tankless Water Heater uses a fully integrated pump to keep hot water close to even the farthest outlet in the home, minimizing the wait and, therefore, the waste of unused potable water down the drain.



Features

In addition to a new integrated recirculation pump, Noritz has redesigned and reformulated the heart of what makes the tankless work - The heat exchanger. By using a special stainless steel blend the heat exchanger has not only gained better efficiency, but also **SUPERIOR** durability.

Industry Leading Warranty

The NRCR features a 15 year warranty on its heat exchangers, which is one of the best warranties on a tankless with an integrated pump.

Best-In-Class Efficiency

The NRCR helps reduce harmful emissions by featuring some of the best UEF ratings in the tankless market.

Re-engineered Heat Exchanger

The NRCR's heat exchangers are composed of high quality stainless steel and designed for easier serviceability.

Steady BTU Mode

An industry first, the NRCR's revolutionary burner control eliminates issues with high incoming water temperature in the summer by reducing effective BTU output to less than 5 KBTU.

Integrated Recirculation Pump

Built with an integrated pump allowing a 1/2" loop with a length of up to 200 feet (or 3/4" up to 500 feet), the longest in the industry.

Technical Specifications

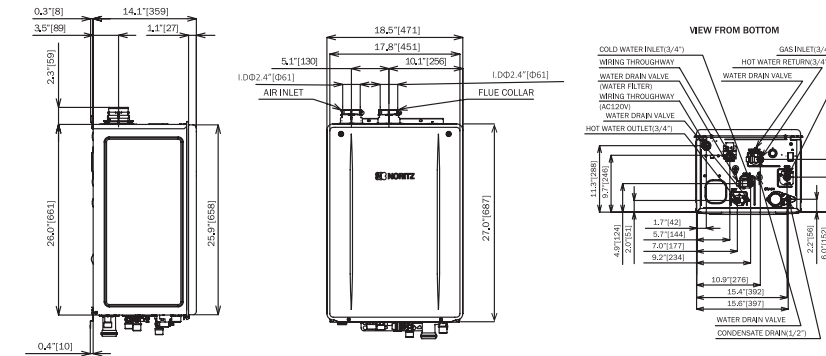

Model	NRCR92DV	NRCR111DV	
GQ Reference Number	GQ-C2660WXQ-FF US	GQ-C3260WXQ-FF US	
BTU Input Range	18,000 - 165,000	18,000 - 199,900	
Min / Max Flow Rate	0.5 GPM - 9.2 GPM	0.5 GPM - 11.1 GPM	
Flow Rate at ΔT	30°F	9.2 GPM	11.1 GPM
	45°F	7.1 GPM	8.7 GPM
	80°F	4.0 GPM	4.9 GPM
Dimensions	27" (Height) x 18.5" (Width) x 14.1" (Depth)		
Weight	73 lbs.		
Connection Sizes	Water Inlet	3/4"	
	Hot Water Inlet	3/4"	
	Gas Inlet	3/4" (1/2" up to 60ft.)	3/4" (1/2" up to 40 ft.)
	Condensing Drain	1/2" Threaded	
Freeze Protection	Yes, pump circulation + resistance heat		
UEF	0.95	0.96	
Warranty	15 Year Warranty on Heat Exchanger, 5 year warranty on parts & 1 year reasonable labor		
Temp Settings	°F Mode	100-140° (In 5° Intervals) (9 Options)	
	°C Mode	37-48°C (In 1°C Intervals), 50-60°C (In 5° Intervals) (15 Options)	
Recirc Lengths	200 feet (1/2") / 500 feet (3/4")		
Venting Lengths	2" PVC (65 feet), 3" PVC (150 feet) or Flex Vent (35 feet)		
Wifi Compatible	Yes		

Featured modes and accessories

Equipped with a variety of customizable modes, the Noritz NRCR helps you simplify and personalize your home's hot water usage.



An industry first, the NRCR's revolutionary burner control eliminates issues with high incoming water temperature in the summer by reducing effective BTU output to less than 5 KBTU. This prevents water temperature fluctuations while keeping your tankless running efficiently.

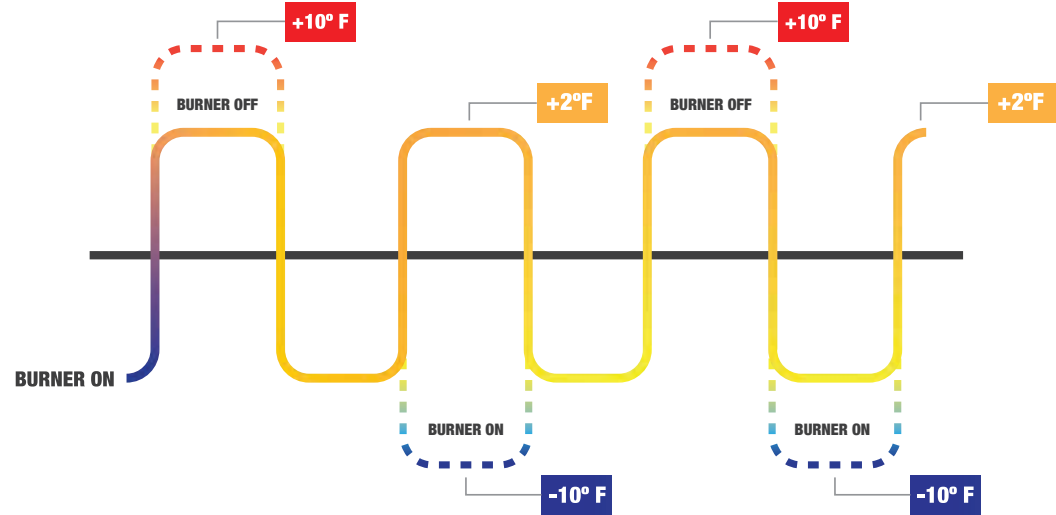

Scan your phone here to watch our SBTU Mode explainer video

Crossover Mode

Is your home missing a return line? Now you can experience home recirculation with the NRCR's Crossover Mode. Utilizing our Crossover Kit (Item# CSV-BPK, sold separately), you can enjoy the full benefits of a recirculation line without the need to install additional piping in your home.

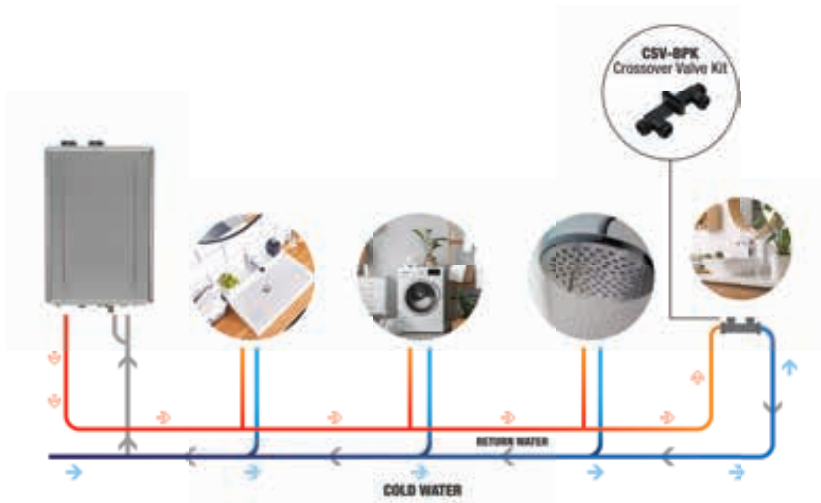

Full Recirculation

Built with an integrated pump, the NRCR brings your home hot water faster than ever by utilizing your dedicated return line.



Accessories

Get ultimate comfort and control out of your NRCR when paired with any of our additional accessories.

New No Roof Kit

NRK-1

The new Noritz No-Roof Kit provides a new venting option by eliminating the need to climb onto the rooftop to complete your installation. The kit also comes with all materials needed, cutting down further install time and material waste.



Scan to Watch Our No Roof Kit Installation Video



2" SV Conversion Kit

SV-CK-2-1

Upgraded for 2022, our 2" single vent conversion kit upgrades direct vent (DV) installs to non-direct vent (SV) operation



Outdoor Vent Kit

VC-6-1

Our new plastic outdoor vent cap is now easier to install and features a new elegant design. Compatible with EZ, NRCR, and NCC199CDV models.

Wireless On-Demand Button Kit For NRCR Series

Want to offer instant hot water with the press of a button? We've got you covered. The latest additions to the Noritz NRCR accessory line-up include a wireless on-demand button kit, an optional motion sensor, and an extra wireless transmitter. The featured products allow full utilization of the NRCR's on-demand recirculation system. Endless hot water just got easier.



1 x Transmitter

Extra WLB Transmitter

WLB-ET

One additional transmitter for WLB wireless on-demand button kit.



1 x Wireless Motion Sensor

Wireless Motion Sensor

WLB-MS

Activate your tankless water heater from anywhere in your home when you come in range of the sensor.



1 x Receiver 2 x Transmitters

Wireless On-Demand Button Kit

WLB

Activate the NRCR's on-demand recirculation mode with this Title 24 compliant wireless push button. Kit contents include 2 wireless transmitters, wireless receiver, and a signal connector.

Additional NRCR Accessories

MODEL NO.	CONTENTS	QTY
CSV-BPK	Crossover Kit	1
EZ2-CK-1	Flex Vent 2" Conversion Kit	1
EZ2-FVK-1	2" Flex Vent Kit (25 ft.)	1
EZ2FVK-2-1	2" Flex Vent Kit (35 ft.)	1
NC-1W	Wall Hanging Residential Condensate Neutralizer Kit	1
IHK-GB	On Demand Button	1
IHK-RS	On Demand Switch	1
PC-10S	Pipe Cover	1
PVC-#LPT	Low Profile Termination Vent	1
RC-9018M	Remote Controller (To set timer manually)	

Now Available - Wifi Connectivity NWC-ADAPTER and Noritz Connect App

Wifi connectivity is now available for the NRCR using the NWC-ADAPTER accessory, allowing full control of temperature, timers, and more when paired with your smartphone and the Noritz Connect app.

Item# NWC-ADAPTER

EZ SERIES

The Noritz EZ Series is the industry leader in tankless. Featuring top mounted connections to accommodate any installation scenario and manufactured with the highest quality materials, the EZ Series line is built to keep your home with hot water for years to come. Our industry-leading 25 year warranty is also just another reason why the EZ Series is the preferred choice for homeowners.



Features

We believe in our product and want homeowners to have the latest and greatest tankless technology available. That's why Noritz has done what no one else has in the tankless industry: We've backed our EZ Series with a 25 year warranty. For more information, visit Noritz.com/EZWarranty

Top Mounted Water Connections

Top mounted connections allow for previous water lines to be reconnected faster.

Dual High Grade Stainless Steel Heat Exchangers

Featuring greater resistance to corrosion and buildup, keeping your system running for years to come.

New Steady BTU Mode

SBTU mode eliminates issues with high incoming water temperature in the summer by reducing effective BTU output to less than 5 KBTU, preventing water temperature fluctuations while keeping your tankless running efficiently.

1/2" Gas Line Compatible

Compatible with most installations, the 3/4" fitting is found underneath the unit for a more convenient install.

Wireless Capability

Combined with the Noritz Connect app, users have control of all heater functions and diagnostic tools.



Unmatched Performance Now With The Industry's Best Warranty

We believe in our product and want homeowners to have the latest and greatest tankless technology available. That's why Noritz has done what no one else has in the tankless industry: We've backed our EZ Series with a 25 year warranty. For more information, visit noritz.com/ezwarranty

Technical Specifications

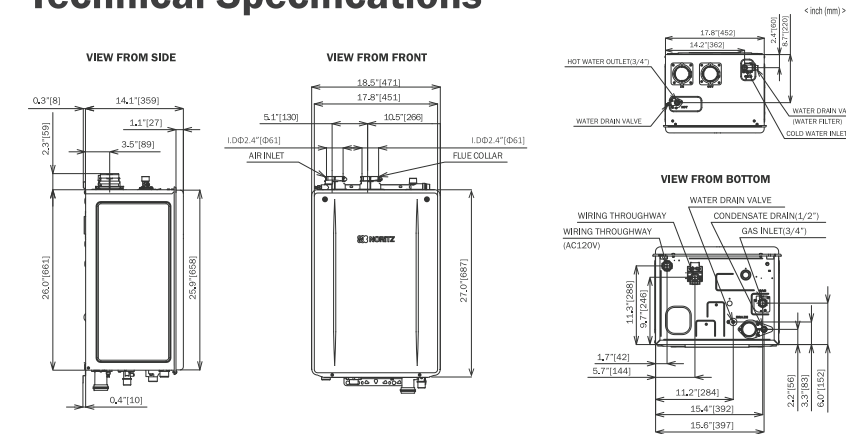

Model	EZ98DV	EZ111DV
GQ Reference Number	GQ-C2860WX-FF US	GQ-C3260WX-FF US
Min./Max. BTU_h	18,000 - 180,000	18,000 - 199,900
Min/Max Flow Rate	0.5 GPM / 9.8 GPM	0.5 GPM / 11.1 GPM
Dimensions (Inches)	27" (Height) x 18.5" (Width) x 14.1" (Depth)	
Weight (lbs)	70 lbs.	70 lbs.
UEF	0.96	0.96
Max. Hot Water Capacity	35°F Rise: 9.8 GPM	35°F Rise: 11.1 GPM
Water Inlet	3/4"	3/4"
Hot Water Outlet	3/4"	3/4"
Gas Inlet (1/2 in. Capable)	3/4" (1/2 in. up to 50 ft.)	3/4" (1/2 in. up to 40 ft.)
Temp. Settings	100-140°F (In 5° intervals)	100-140°F (In 5° intervals)
Default Temp. Option	120, 125, 130, 140°F	120, 125, 130, 140°F
Warranty	25 Year Heat Exchanger, 5 year warranty on parts & 1 year reasonable labor	
Ultra Low NO_x	Yes	
Quick Connect	Yes	
Remote Included	Yes	
Wifi Compatible	Yes	
High Altitude Approved	Up to 10,000 ft.	
Mobile Home Approved	Yes (OD or DV Install Only)	Yes (OD or DV Install Only)
PVC	2" or 3"	
Energy Star	Yes	
Pump Kit Compatible	Yes	

EZ SERIES Accessories

Install It Your Way

The Noritz EZ Series adapts to your installation needs, providing professional installers and their homeowner customers with a wider range of tankless options, covering the majority of residential, tank-replacement opportunities. Choose the way you install the EZ98 or EZ111 with any of these available accessories. Tackle a wide variety of install scenarios with the most versatile tankless on the market.

New No Roof Kit NRK-1

The new Noritz No-Roof Kit provides a new venting option by eliminating the need to climb onto the rooftop to complete your installation. The kit also comes with all materials needed, cutting down further install time and material waste.

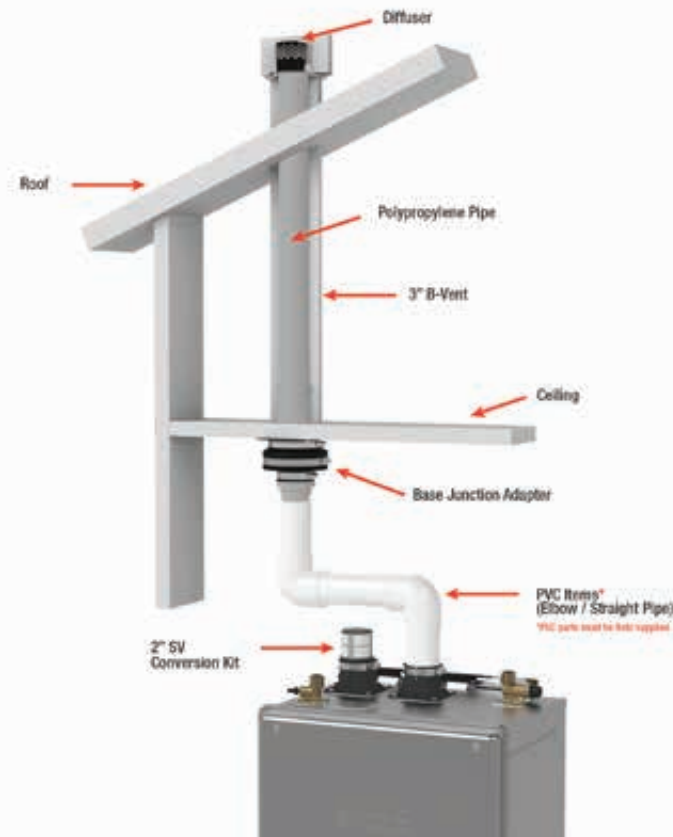

Direct Vent Utilizing 2\"/>

Additional Optional Accessories:
PVC concentric horizontal termination kit

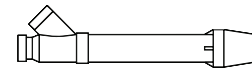

Single Vent 2\"/>

Upgraded for 2022, our 2\"/>



Outdoor Installation Outdoor Vent Cap VC-6-1

The Outdoor Vent Kit allows for outdoor installations of your EZ Series tankless. Our new plastic outdoor vent cap is now easier to install and features a new elegant design.



Scan to Watch Our
No Roof Kit
Installation Video

EZ SERIES Flex Vent Kits

Available in both 25 and 35 feet, our flex vent kits are designed to bring homeowners more installation versatility and come with all the necessary parts making it easy to install the Noritz EZ Series of your choice.

EZTR 2\"/>

Accessories required for this install:

EZ2FVK-1



EZ2-CK-1

Required To Utilize Flex Vent Kits For EZ98/111 and NRCR



Flex Vent 2\"/>

25 Ft.
Flex Vent Included



Optional Accessory

Optional Diffuser Kit
(For use if keeping
existing rain cap)

EZ2-DK-1 (25')



Install Through Existing B-Vent Up To 25 Feet (Optional, Sold Separately)

EZTR 2\"/>

Accessories required for this install:

EZ2FVK-2-1

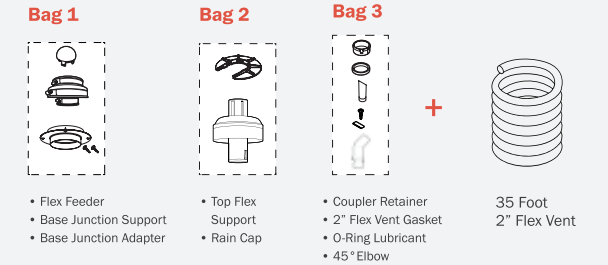

EZ2-CK-1

Required To Utilize Flex Vent Kits For EZ98/111 and NRCR



Flex Vent 2\"/>

35 Ft.
Flex Vent Included



Optional Accessory

Optional Diffuser Kit
(For use if keeping
existing rain cap)

EZ2-DK-2 (35')



Install Through Existing B-Vent Up To 35 Feet (Optional, Sold Separately)

Wirelessly Control Your Noritz Tankless

Wireless control for your Noritz tankless is now at your fingertips. Set water temperatures and perform troubleshooting from your mobile phone when you pair our wireless adapter and Noritz Connect app today!

Diagnose And Maintain

Homeowner and contractor alerts & reminders for fast and proactive maintenance.

Wireless Control

Control heater functions over our full featured app.

Flexible Installation

Weather resistant wireless adapter allows for installation indoors or outdoors.

Usage Statistics

Track your usage over time with generated charts based on your use.



NWC-ADAPTER
Wireless Adapter

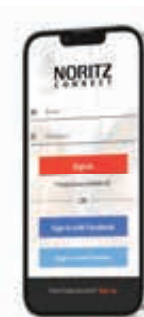

NORITZ CONNECT

Control at your Fingertips

Pair our NWC-Adapter with the Noritz Connect App for wireless control of your tankless water heater.

For more information visit

WIFI.NORITZ.COM

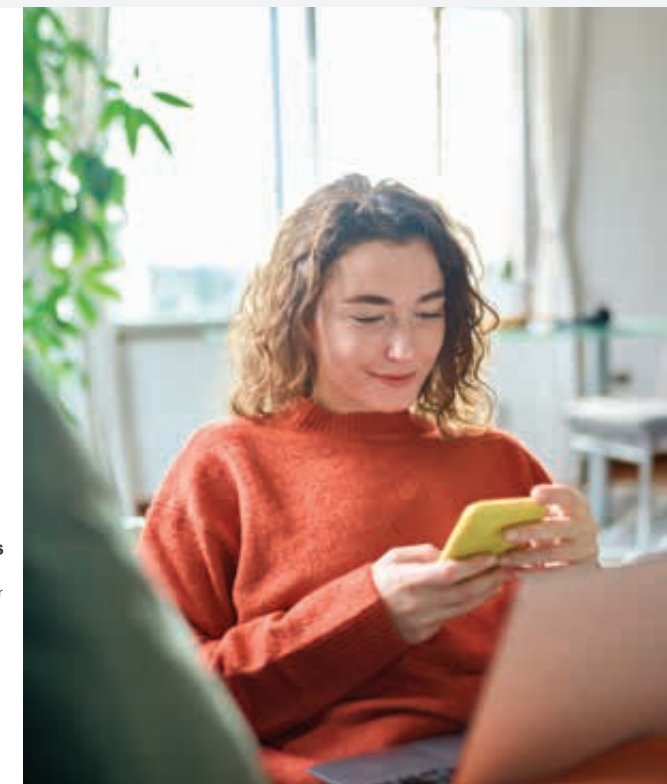

EZTR BUNDLES

All-In-One Residential Tank Replacement Bundle

The Noritz EZTR bundles include select accessories to help get you up and running with your installation. Each model is designed for different water demands for residential applications.

All Parts Needed for Installation Included

Each EZTR50 and EZTR75 bundle includes the heater itself, a flex vent conversion kit (25 feet of 2-inch flex), an isolation valve kit, and a startup guide. The EZTR40 also comes with a heater, vent kit, and service valves.

EZ2-CK-1

Required To Utilize Flex Vent Kits For EZ98/111 and NRCR



Flex Vent 2" Conversion Kit

25 ft. 2" Flex Vent



Isolation Valves/ PRV included



Aluminum Flex Sleeve



EZTR50

50 Gallon Tankless Bundle

The EZTR50 package comes with an EZ98DV tankless, plus all the aforementioned components, for replacement of a 50-gallon tank water heater.



EZTR75

75 Gallon Tankless Bundle

The EZTR75 package contains an EZ111DV tankless, plus all the aforementioned components, for replacement of a 75-gallon tank water heater.



EZTR40

40 Gallon Tankless Bundle

The EZTR40 package is designed for quick and direct indoor replacement of 40-gallon tank water heaters.

Technical Specifications

	Vents Through Existing, Round 3" Or 4" B-Vent		
	2" Flex	PVC, 2" Flex, OD or SV Convertible	
Model	EZTR40	EZTR50	EZTR75
GQ Reference Number	NRC663-FSV	EGQ-C2860WX-FF US	EGQ-C3260WX-FF US
Vent Type	Flex Vent	Convertible Vent	Convertible Vent
Dimensions (inches)	27.2 x 18.3 x 9.4	27.0 x 18.5 x 14.1	27.0 x 18.5 x 14.1
Weight (lbs)	50 lbs.	70 lbs.	70 lbs.
Min. / Max. BTUh	15,000 - 120,000	18,000 - 180,000	18,000 - 199,900
UEF	0.87	0.96	0.96
Max. Hot Water Capacity	6.6 GPM	9.8 GPM	11.1 GPM
Water Inlet		3/4"	
Hot Water Outlet		3/4"	
Gas Inlet (1/2 in. capable)	1/2" (1/2 in. up to 100 ft.)	3/4" (1/2 in. up to 50 ft.)	3/4" (1/2 in. up to 40 ft.)
Temp. Settings	115 - 140°F (In 5° Intervals)	100-140°F (In 5° intervals)	
Warranty	12 year warranty on heat exchanger, 5 year warranty on parts, & 1 year reasonable labor	INDUSTRY LEADING 25 YEAR HEAT EXCHANGER WARRANTY 5 year warranty on parts & 1 year reasonable labor	
Ultra Low NOx		Yes	
Quick Connect	No	Yes	
Remote Included	Digital Display	Yes	
Min. / Max. Flow Rate	0.5 GPM / 6.6 GPM	0.5 GPM / 9.8 GPM	0.5 GPM / 11.1 GPM
High Altitude Approved	Up to 3,500 ft.	Up to 10,000 ft.	
Indoor / Outdoor	Indoor Only	Indoor / Outdoor	
Wifi Compatible		Yes	
Pump Kit Compatible	No	Yes	
EZTR / EZ Series Options			
Bundle	Yes	Yes (Model EZTR50)	Yes (Model EZTR75)
Sold Separately	No	Yes (Model EZ98)	Yes (Model EZ111)



Combination Boiler

NRCB

The New Hero in Home Heating and Hot Water

Most combination boilers prioritize the call for hot water while your home is being heated. This causes your home heating to go cold while things like the shower are running. The NRCB is the industry's first to be able to handle both simultaneously to provide ease and comfort.

Features

- » Corrosion Resistant
- » Self Regulating Flow
- » 2" and 3" PVC, CPVC and PP Venting Capable
- » 11:1 Turn down Ratio
- » 1/2 Inch Gas Line Capable
- » High Grade Stainless Steel Heat Exchangers
- » Outdoor Temperature Reset Sensor
- » External Pump Terminal
- » Scalding Prevention for DHW Safety
- » Up to 11.1 GPM
- » High Capacity Internal Pump
- » Maintains Set DHW Temp. in All Conditions
- » Simultaneous DHW and Heat¹
- » Larger hot water demand can be connected with EZ Series

¹ Dependant on heating and DHW set temperatures

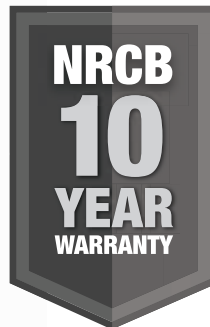

Technical Specifications

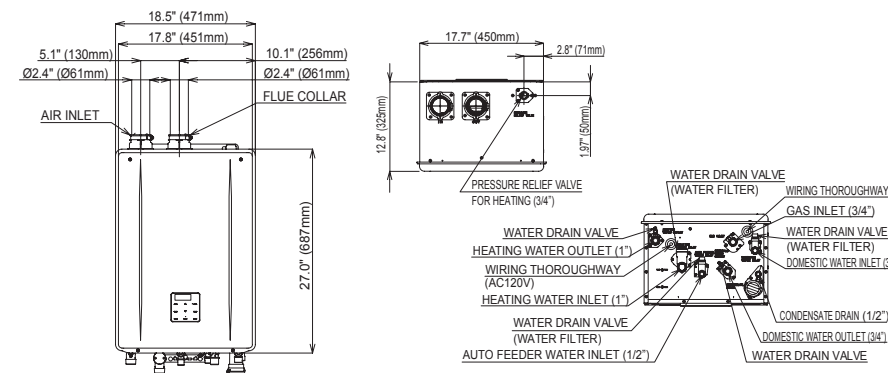

Model		NRCB180DV	NRCB199DV
GQ Reference Number		GHQ-C2801WX-FF US	GHQ-C3201WX-FF US
Gas Input Rate (Domestic Hot Water Mode)	Max	180,000 BTU/h	199,900 BTU/h
	Min	18,000 BTU/h	18,000 BTU/h
Gas Input (Heating Mode)	Max	100,000 BTU/h	120,000 BTU/h
	Min	18,000 BTU/h	18,000 BTU/h
Hot Water Capacity Flow Rate	35° F Rise	9.8 GPM	11.1 GPM
	45° F Rise	7.5 GPM	8.4 GPM
	80° F Rise	4.3 GPM	4.7 GPM
Installation		Indoor / Outdoor with VCK-NRCB (sold separately)	
Flue System		Sealed Combustion Direct Vent, Single Vent	
Gas Pressure	NG	3.5" WC-10.5" WC	
	LP	8.0" WC-14.0" WC	
Heat Exchanger	Primary	SS316L (Austenite)	
	Secondary	SS316L (Austenite)	
	Plate Type Heat Exchanger	SCR (Austenite)* *Stress Corrosion Resistant	
DHW Heating Priority		Simultaneous Heating and Domestic Capable	
AFUE		95%	

Features

Homeowners will enjoy the improved comfort made possible by the unit's ability to simultaneously¹ heat domestic water and room space. No longer will the possibility exist of a shower impacting room temperature.

All Stainless Steel Heat Exchangers (3 Total)

Made with high quality stainless steel, these main components are built to last and bring you years of heating and hot water.

Ultra Low Emissions By Premix Burner

The NRCB's Premix Burner help eliminate harmful emissions into the environment.

High Delivering Capacity Of DHW (Max 199k / 180k BTU/h)

High delivery capacity ensures your home is never without hot water again.

Simultaneous Operating Of DHW And Heating¹

The NRCB is the industry's first tankless combi boiler to offer simultaneous DHW and home heating.

Stability And Quick Temperature Control Of DHW And Heating

Prevent temperature spikes with our built-in stability and quick temp control.

¹ Dependent on heating and DHW temperatures



Commercial Tankless Water Heater

NCC199CDV

The new NCC199CDV provides industry leading performance for any commercial water heating application. An impressive 10-year heat exchanger warranty comes included, providing businesses with years of hot water without the worry.

Next Gen TRUE Commercial Tankless

T Trusted

Since 1951, Noritz commitment and mission has been to "make people happy through hot water." With over 16,000,000 units serving people's hot water needs worldwide, our goal is to provide sustainable customer focused solutions for hot water.

R Reliable

Noritz Commercial Tankless Water Heaters are modular and can be linked to create redundancy. Even when one unit needs service or is not in operation, hot water will be delivered seamlessly by other units in the system. Noritz Redundancy in commercial applications provides a reliable, uninterrupted source of hot water which translates to piece of mind for our customers & their bottom line.

U Unmatched

Noritz Commercial Tankless Water Heaters are the only TRUE commercial grade tankless water heaters on the market and we continue to lead the industry in terms of innovation, quality, and performance. In addition, Noritz Intelligent Modular Water Heating Technology can link up to 24 units in a single system providing unmatched performance and reliability.

E Efficient

For the rest of the pack, efficiency is a mere watermark to aim for. For Noritz, efficiency is our name. From an ultra efficient 0.96 UEF to the lean JPS just in time manufacturing process we utilize to manufacture our product.



**ENERGY STAR
CERTIFIED**



Technical Specifications

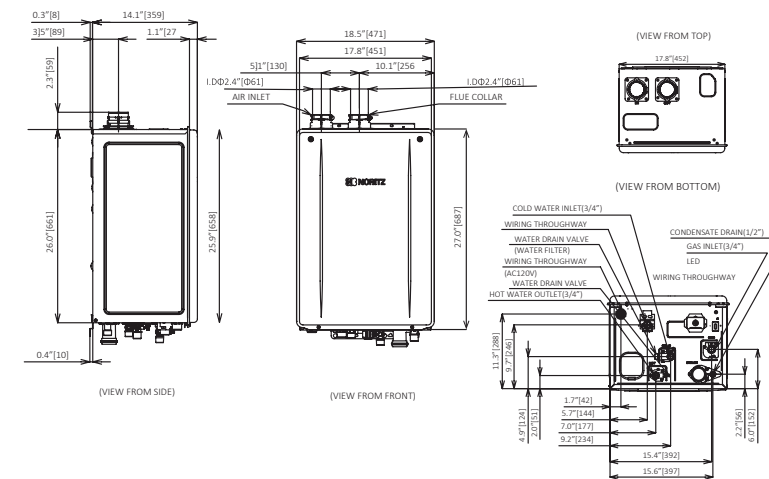

Model		NCC199CDV
Min. / Max. BTU		18K - 199,900 BTU _h
Capacity Range		0.5 - 11.1 GPM (30°F Rise)
Weight		70 lbs.
UEF		0.96
Connection Sizes	Water Inlet	NPT 3/4"
	Hot Water Outlet	NPT 3/4"
	Gas Inlet	NPT 3/4"
	Condensate Drain	NPT 1/2"
Water Holding Capacity		0.82 Gallon (3.1 L)
Temperature Settings	°F Mode	100-150° (In 5° F Intervals) 160° F, 170° F, 185° F (14 Options)
	°C Mode	37-48° C (In 1°C intervals), 50-85°C (In 5° intervals) (20 options)
Operating Pressure		15-150 psi (Recommended 50 to 80 psi for maximum performance)
Included Accessories		Remote controller, remote controller cord, anchoring screws, wall mounting bracket

Features

In addition to our industry-leading warranty, the NCC199CDV various features businesses need for seamless operation, including high grade heat exchangers, common venting for multiple units, and a high efficiency for continuous energy savings throughout the life of their system.

10 Year Heat Exchanger Warranty

The Noritz NCC199CDV is backed with a 10 year heat exchanger warranty. Visit NORITZ.COM/CDVWARRANTY for more details.

Dual High Grade Stainless Steel Heat Exchangers

The right materials for the right situation. The NCC199CDV utilizes 2 types of stainless steel: High temperature for the primary and corrosion resistant for the secondary.

Pre-Mix Burner

Combined with a unique negative pressure Venturi gas valve, the NCC199CDV is Energy Star certified & features an ultra-efficient 0.96 UEF.

New Common Vent Capability

Provides scalability of up to 6 heaters on a single venting system without the need for an external non-return valve.

2" Vent Connections

Offers flexible venting options for vertical or horizontal termination with PVC, CPVC, or PP venting, as well as outdoor installations with OD vent cap. Ability to vent up to 65' with 2" and 150' with 3" materials.

Ultra Low Nox

Produces only 14 ppm. 33% less emissions than the SCAQMD limitations of 20ppm NO_x.

Commercial Rack System (CR)

Noritz offers a commercial water heating solution that gives you all the benefits of tankless water heaters in one easy to install pre-fabricated package. Ideal for an existing or planned boiler and storage tank replacement, the Noritz Commercial Rack (CR) system (formerly CWHS) is made to provide a true alternative or supplement to the old storage tank setup.



Preengineered Rack Systems

The CR is a pre-fabricated racking system for use in flat rooftop or mechanical room applications for commercial multi-systems. A low profile design and a variety of installation options make this rack system ideal for business owners looking to replace outdated storage tanks.



Flexibility

The new CR offers unmatched versatility and flexibility compared against a boiler or storage system. At 30" in depth, the CR system can fit through any standard 32" doorway. Able to be installed indoors or outdoors, floor-mounted or wall-mounted, the possibilities for reducing building footprint are extensive. Indoor installations can be vented with PVC, CPVC, or PP, either horizontally or vertically, and convertible to allow either room air or direct vent combustion air options.



Efficiency

Each CR system comes standard with the ultra-efficient NCC199CDV model unit, rated at 0.96 UEF. Fully modulating, with turn-down ratios of up to 67:1², the CR system provides exceptional energy savings potential over a storage tank set up. With all of these benefits plus the Noritz trademark quality, the Noritz CR system provides a true business-friendly replacement for any existing system.



Redundancy

Built-in redundancy from using multiple Noritz water heaters ensures continuous hot water, even in the worst case of a unit going down. Isolation valves (included) allow for easy maintenance or service without interrupting hot water service to the rest of the building. The pre-installed (included) system controller monitors and controls the units to ensure even wear and proper operation of each unit.

With the optional wireless adapter³, you can further enhance system reliability by monitoring the units at the touch of a finger and receiving service alerts automatically.

¹Floor mounted racks only
²With one 6 unit system CR rack. Multiple racks can be combined together to get turn down ratios of up to 300:1 with 24 units and the SC-401-24M system controller.
³NWCC-ADAPTER

Features and Benefits

New Low Profile Design
 Redesigned with lower center of gravity for increased stability and easier transportation.

Easy Scalability
 Standardized water and gas lines allow easy connection of multiple rack systems in-line.

Reduced Install Time
 Pre-piped condensate manifold and condensate line along with pre-wiring required for multi-systems reduces installation time.

New Wall Mount Option
 The redesigned wall mounted option allows for more space savings without sacrificing performance.

Simplified Venting
 Built-in non-return valve allows for common venting up to 6 units on a single manifold without the need for external accessories.

Commercial Rack System Dimensions

Item Number	Rack Type	UPC	Included Main Components		Cold / Hot Water & Gas Manifold				Rack Dimensions			Weight (lbs)
			GQ-C3260WZ-FF US	SC-401-6M	Cold	Hot	Condensate Drain Manifold	Gas Manifolds	L	D	H	
CR60-WH-2-LP	2 Unit Wall Hanging, LP	860003319932	2	1	2"	2"	3/4"	2"	54 1/4"	17"	44"	259
CR60-WH-2-NG	2 Unit Wall Hanging, NG	860003319949										
CR60-WH-3-LP	3 Unit Wall Hanging, LP	860003319956	3	1	2"	2"	3/4"	2"	78"	17"	44"	386
CR60-WH-3-NG	3 Unit Wall Hanging, NG	860003319963										
CR60-FS-3-LP	3 Unit Free Standing, LP	850018743556	3	1	2"	2"	3/4"	2"	52 1/4"	30"	56 3/4"	386
CR60-FS-3-NG	3 Unit Free Standing, NG	850018743549										
CR60-FS-4-LP	4 Unit Free Standing, LP	860003319970	4	1	2"	2"	3/4"	2"	54 1/4"	30"	56 3/4"	444
CR60-FS-4-NG	4 Unit Free Standing, NG	860003319987										
CR60-FS-5-LP	5 Unit Free Standing, LP	850018743099	5	1	2"	2"	3/4"	2"	78"	30"	56 3/4"	560
CR60-FS-5-NG	5 Unit Free Standing, NG	850018743082										
CR60-FS-6-LP	6 Unit Free Standing, LP	817000013752	6	1	2"	2"	3/4"	2"	78"	30"	56 3/4"	641
CR60-FS-6-NG	6 Unit Free Standing, NG	860003319994										

CA Update Commercial Rack System Dimensions

Item Number	Rack Type	UPC	Included Main Components		Cold / Hot Water & Gas Manifold				Rack Dimensions			Weight (lbs)
			GQ-C3260WZ-FF US	SC-401-6M	Cold	Hot	Condensate Drain Manifold	Gas Manifolds	L	D	H	
CR60-WH-2-LP-CA	2 Unit Wall Hanging, LP	850018743365	2	1	2"	2"	3/4"	2"	54 1/4"	17"	44"	259
CR60-WH-2-NG-CA	2 Unit Wall Hanging, NG	850018743358										
CR60-WH-3-LP-CA	3 Unit Wall Hanging, LP	850018743389	3	1	2"	2"	3/4"	2"	78"	17"	44"	386
CR60-WH-3-NG-CA	3 Unit Wall Hanging, NG	850018743372										
CR60-FS-3-LP-CA	3 Unit Free Standing, LP	850018743570	3	1	2"	2"	3/4"	2"	52 1/4"	30"	56 3/4"	386
CR60-FS-3-NG-CA	3 Unit Free Standing, NG	850018743563										
CR60-FS-4-LP-CA	4 Unit Free Standing, LP	850018743402	4	1	2"	2"	3/4"	2"	54 1/4"	30"	56 3/4"	444
CR60-FS-4-NG-CA	4 Unit Free Standing, NG	850018743396										
CR60-FS-5-LP-CA	5 Unit Floor Mount, LP	850018743426	5	1	2"	2"	3/4"	2"	78"	30"	56 3/4"	560
CR60-FS-5-NG-CA	5 Unit Floor Mount, NG	850018743419										
CR60-FS-6-LP-CA	6 Unit Free Standing, LP	850018743440	6	1	2"	2"	3/4"	2"	78"	30"	56 3/4"	641
CR60-FS-6-NG-CA	6 Unit Free Standing, NG	850018743433										

Hot Water Supply Capacity

Item Number	Heater Qty	Heater Configuration	Min BTU/hr Input	Max BTU Input	Hot Water Capacity (GPM)						
					50°	60°	70°	80°	90°	100°	110°
CR60-WH-2-LP	2	Wall Hanging In-Series	18,000	399,800	15.7	13.1	11.2	9.8	8.7	7.8	7.1
CR60-WH-2-NG											
CR60-WH-3-LP	3	Wall Hanging In-Series	18,000	599,700	23.5	19.6	16.8	14.7	13.1	11.8	10.7
CR60-WH-3-NG											
CR60-FS-3-LP	3	Free Standing	18,000	599,700	23.5	19.6	16.8	14.7	13.1	11.8	10.7
CR60-FS-3-NG											
CR60-FS-4-LP	4	Free Standing 2x2 Back to Back	18,000	799,600	31.3	26.1	22.4	19.6	17.4	15.7	14.2
CR60-FS-4-NG											
CR60-FS-5-LP	5	Free Standing 3x2 Back to Back	18,000	999,500	39.2	32.7	28.0	24.5	21.8	19.6	17.8
CR60-FS-5-NG											
CR60-FS-6-LP	6	Free Standing 3x3 Back to Back	18,000	1,199,400	47.0	39.2	33.6	29.4	26.1	23.5	21.4
CR60-FS-6-NG											

Additional System Options and Accessories

2020 CA System Update



The updated CR system update comes with a redesigned gas header with built-in gas sediment traps and an additional shutoff valve, simplifying both installation and service.

Wall Hanging Rack



Our wall hanging rack allows installers to accommodate for existing conduit and piping without interference, reducing additional installation time.

CR60 Wheel Kit



Noritz CR60 Wheel Kit is designed to simplify logistics of moving all Noritz Commercial Racks configurations from the crate to the mechanical room.



High Efficiency (Condensing)

EZ, NRCR & NRC						
	Model	EZ111DV	NRCR111DV	NRC111DV	NRC111OD	EZ98DV
GQ Reference Number	GQ-C3260WX-FF US	GQ-C3260WXQ-FF US	GQ-C3257WX-FF US	GQ-C3257WX US	GQ-C2860WX-FF US	GQ-C2660WXQ-FF US
Vent Type	Versatile Venting	Versatile Venting	DV	OD	Versatile Venting	Versatile Venting
SV Conversion	Yes	Yes	Yes	N/A	Yes	Yes
Dimensions (Inches)	27" x 18.5" x 14.1"	27" x 18.5" x 14.1"	24.2" x 18.3" x 9.4"	24.2" x 18.3" x 9.4"	27" x 18.5" x 14.1"	27" x 18.5" x 14.1"
Weight (lbs)	70 lbs.	73 lbs.	68 lbs.	66 lbs.	70 lbs.	73 lbs.
Min./Max. BTUh	18,000 - 199,900	18,000 - 199,900	16,000-199,900	16,000-199,900	18,000 - 180,000	18,000 - 165,000
UEF	0.96	0.96	0.91	0.91	0.96	0.95
Max. Hot Water Capacity	35°F Rise: 11.1 GPM			35°F Rise: 9.8 GPM		35°F Rise: 9.2 GPM
Water Inlet	3/4"			3/4" (1/2" up to 60 ft.)		
Hot Water Outlet	3/4"			3/4" (1/2" up to 60 ft.)		
Gas Inlet (1/2 in. capable)	3/4" (1/2 in. up to 40 ft.)			3/4" (1/2 in. up to 50 ft.)		3/4" (1/2" up to 60 ft.)
Temp. Settings	100-140°F (In 5° intervals)					
Default Temp. Option	N/A		120, 125, 130, 140°F		N/A	
Warranty	25 YEAR HEAT EXCHANGER, 5 year warranty on parts & 1 year reasonable labor	15 YEAR HEAT EXCHANGER, 5 year warranty on parts & 1 year reasonable labor	12 year warranty on heat exchanger, 5 year warranty on parts & 1 year reasonable labor (Residential Installs)		25 YEAR HEAT EXCHANGER, 5 year warranty on parts & 1 year reasonable labor	15 YEAR HEAT EXCHANGER, 5 year warranty on parts & 1 year reasonable labor
Ultra Low NOx	Yes					
Quick Connect	Yes					
Remote Included	Yes					
Min/Max Flow rate	0.5 GPM / 11.1 GPM	0.5 GPM / 11.1 GPM	0.5 GPM / 11.1 GPM		0.5 GPM / 9.8 GPM	0.5 GPM / 9.2 GPM
Wifi Compatible	Yes					
High Altitude Approved	Up to 10,000 ft.		Up to 8,000 ft.		Up to 10,000 ft.	
Mobile Home Approved	Yes (OD or DV Install Only)					
PVC	2" or 3"	2" or 3"	3" or 4"	No	2" or 3"	
Energy Star	Yes					
Pump Kit Compatible	Yes	No	Yes		No	
Venting	2" / 3" PVC Vent 2" Flex Pipe		3" / 4" PVC Vent		N/A	2" / 3" PVC Vent 2" Flex Pipe

Vent Type

DV - PVC, CPVC, PP Vent
SV - Stainless Steel Vent
DVC - Concentric, Stainless Steel Vent
OD - Outdoor Vent

Versatile Venting

See page 14

Approvals

Residential



High Efficiency (Condensing)

NRC						
	Model	NRC98DV	NRC98OD	NRC71DV	NRC71OD	NRC66DV
GQ Reference Number	GQ-C2857WS-FF US	GQ-C2857WS US	N/A	N/A	N/A	N/A
Vent Type	DV	OD	DV	OD	DV	OD
SV Conversion	Yes	N/A	Yes	N/A	Yes	N/A
Dimensions (Inches)	24.2" x 18.3" x 9.4"	24.2" x 18.3" x 9.4"	23.6" x 13.8" x 6.7"	20.5" x 13.8" x 6.7"	23.6" x 13.8" x 6.7"	20.5" x 13.8" x 6.7"
Weight (lbs)	58 lbs.	57 lbs.	41 lbs.	40 lbs.	39 lbs.	36 lbs.
Min./Max. BTUh	16,000 - 180,000	16,000 - 180,000	15,000 - 157,000	15,000 - 157,000	15,000-120,000	15,000-120,000
UEF	0.91	0.92	0.89	0.89	0.89	0.89
Max. Hot Water Capacity	35°F Rise: 9.8 GPM	35°F Rise: 9.8 GPM	30°F Rise: 7.1 GPM	30°F Rise: 7.1 GPM	30°F Rise: 6.6 GPM	30°F Rise: 6.6 GPM
Water Inlet	3/4"					
Hot Water Outlet	3/4"					
Gas Inlet (1/2 in. capable)	3/4" (1/2 in. up to 50ft)		3/4" (1/2 in. up to 70ft)		1/2" (1/2 in. up to 100 ft)	1/2" (1/2 in. up to 100 ft)
Temp. Settings	115-140°F (In 5° Intervals)					
Default Temp. Option	120, 125, 130, 140°F		120, 130, 135, 140°F		120, 130, 135, 140°F	120, 130, 135, 140°F
Warranty	12 year warranty on heat exchanger, 5 year warranty on parts & 1 year reasonable labor (Residential Installs)					
Ultra Low NOx	Yes					
Quick Connect	Yes			No		
Remote Included	Yes			Digital Display		
Min/Max Flow rate	0.5 GPM / 9.8 GPM		0.5 GPM / 7.1 GPM	0.5 GPM / 7.1 GPM	0.5 GPM / 6.6 GPM	0.5 GPM / 6.6 GPM
Wifi Compatible	Yes					
High Altitude Approved	Up to 8,000 ft.					
Mobile Home Approved	Yes (OD or DV Install Only)					
PVC	3" or 4"	No	3"	No	3"	No
Energy Star	Yes					
Pump Kit Compatible	Yes			No		
Venting	3" / 4" PVC Vent	N/A	3" PVC Vent	N/A	3" PVC Vent	N/A

Mid Efficiency (Non Condensing)

NR



Model	NR98DVC	NR98SV	NR98OD	NR83DVC	NR83OD	NR66OD	NR50OD
GQ Reference Number	GQ-2857WX-FFA US	GQ-2857WX-F US	GQ-2857WX US	GQ-2457WS-FFA US	GQ-2457WS US	N/A	N/A
Vent Type	DVC	SV	OD	DVC	OD	OD	OD
SV Conversion	N/A						
Dimensions (Inches)	23.6" x 13.8" x 9.4"	23.6" x 13.8" x 9.4"	23.6" x 13.8" x 9.4"	23.6" x 13.8" x 9.4"	23.6" x 13.8" x 9.4"	20.5" x 13.8" x 6.7"	20.5" x 13.8" x 6.7"
Weight (lbs)	58 lbs.	54 lbs.		49 lbs.	45 lbs.	35 lbs.	32 lbs.
Min./Max. BTUh	16,000 - 199,900			18,000 - 180,000		15,000-140,000	15,000-120,000
UEF	0.82						
Max. Hot Water Capacity	45 °F Rise: 7.5 GPM			30 °F Rise: 8.3 GPM		30 °F Rise: 6.6 GPM	30 °F Rise: 5.0 GPM
Water Inlet	3/4"						
Hot Water Outlet	3/4"						
Gas Inlet (1/2 in. capable)	3/4" (1/2" up to 40ft)			3/4" (1/2" up to 50ft)		3/4" (1/2" up to 80ft)	1/2" (1/2" up to 100ft)
Temp. Settings	100-140 °F (In 5° Intervals)			115-140 °F (In 5° Intervals)			
Default Temp. Option	120, 125, 130, 140 °F				120, 130, 135, 140 °F		
Warranty	12 year warranty on heat exchanger, 5 year warranty on parts & 1 year reasonable labor* (Residential Installs)						
Ultra Low NOx	Yes						
Quick Connect	Yes				No	No	
Remote Included	Yes				Digital Display		
Min/Max Flow rate	0.5 GPM / 9.8 GPM			0.5 GPM / 8.3 GPM		0.5 GPM / 6.6 GPM	0.5 GPM / 5.0 GPM
Wifi Compatible	Yes						
High Altitude Approved	Up to 8,000 ft.						
Mobile Home Approved	Yes	No		Yes			
PVC	No						
Energy Star	No						
Bundle Kit	Yes	No		Yes	No		No
Pump Kit Compatible	Yes					No	

Commercial Models

NC
NCC



	Condensing			Non-Condensing		
Model	NCC3000D	NCC300DV	NCC199CDV	NC380SV	NC199DVC	NC199OD
GQ Reference Number	GQ-C5032WZ US	GQ-C5032WZ-FF US	GQ-C3260WZ-FF US	N/A	GQ-2857WZ-FFA US	GQ-2857WZ US
SV Conversion	N/A	Yes	Yes	No	N/A	N/A
Vent Type	OD	DV	DV / OD	SV	DVC	OD
Dimensions (Inches)	32.7" x 18.9" x 14.2"	32.7" x 18.9" x 14.2"	27.0" x 18.5" x 14.1"	29.7" x 19.1" x 11.8"	23.6" x 13.8" x 11.0"	23.6" x 13.8" x 9.4"
Weight (lbs)	108 lbs.		70 lbs.	106 lbs.	58 lbs.	54 lbs.
Min./Max. BTUh	15,000 - 300,000**		18,000 - 199,900	22,500 - 380,000**	16,000 - 199,900	
Thermal Efficiency / UEF	97%		0.96 UEF	NG: 80% LP: 81%	0.82 UEF	
Max. Hot Water Capacity	35 °F Rise: 13.2 GPM		35 °F Rise: 11.1 GPM	35 °F Rise: 13.2 GPM	35 °F Rise: 9.8 GPM	
Water Inlet	1"		3/4"	1"	3/4"	3/4"
Hot Water Outlet	1"		3/4"	1"	3/4"	3/4"
Gas Inlet (1/2 in. capable)	3/4"		3/4"	3/4"	3/4"	3/4"
Temp. Settings	100-150 °F (In 5 °F Intervals), 160, 170, 185 ° F			100-150 °F (In 5 °F Intervals), 160, 170, 180 °F	100-150 °F (In 5 ° F Intervals), 160, 170, 185 ° F	
Default Temp. Option	N/A			120, 130, 140, 180 °F	120, 130, 140, 185 °F	
Warranty	5 year warranty on heat exchanger, 5-year warranty on parts & 1-year reasonable labor*		10 year warranty on heat exchanger , 5 year warranty on parts & 1 year reasonable labor*	5 year warranty on heat exchanger, 5 year warranty on parts & 1 year reasonable labor*		
Ultra Low NOx	Yes			No	Yes	
Quick Connect	Yes					
Remote Included	Yes					
Min/Max Flow rate	0.5 GPM / 13.2 GPM		0.5 GPM / 11.1 GPM	0.7 GPM / 13.2 GPM	0.5 GPM / 9.8 GPM	
High Altitude Approved	Up to 4,500 ft.		Up to 10,000 ft.	Up to 8,000 ft.		
Wifi Compatible	Yes					
Common Vent Capable	No	Up to 6 Units		No		
Commercial Energy Star	Yes					
PVC	No	Yes		No		
ASME	No***			No	Yes	

Approvals

Commercial



Add "-NG" or "-LP" to the end of the model number to specify gas type.
 *Refer to our warranty terms & conditions for more details.
 **Disclaimer: For units with more output than 200,000 BTUh, please check with your local boiler inspector to verify if ASME is required in your state.
 ***Only available for installation in the following states: California, Minnesota, and Wisconsin. Please check your local codes for details.

Accessories

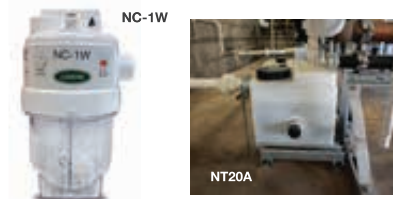

NC-1W / NT20A

Condensate Neutralizer Kit

Model Number	Qty	Description
NC-1W	1	Residential condensate neutralizer kit for NRC111, NRC98, NRC711, NRC66, EZTR40, EZ98, EZ111, NRCB, and NRRC
NT20A	1	Commercial condensate neutralizer kit for NC199, NCC199CDV, and NCC300 series



PC-#

Pipe Cover

Model Number	Qty	Description
PC-1S	1	Pipe Cover (NRC66, NRC71, NR50, NR66)
PC-2S	1	Pipe Cover (NR98SV/OD, NR830D)
PC-2S-GRY	1	Stone gray pipe cover for NC1990D
PC-3S	1	Pipe cover (NRC98DV/OD & NRC111DV/OD)
PC-4S-SUS	1	Stainless Steel PC for NC380SV
PC-5S	1	Pipe cover for NR98DVC & NR83DVC
PC-5S-GRY	1	Stone gray pipe cover for NC199DVC
PC-7S	1	Pipe cover for NCC300 OD/DV
PC-10S	1	Pipe cover for NRRC, EZ Series (GQ60 Models), and NCC199CDV (GQ60 Model)

DSCL-KIT

Noritz Descale Kit

Model Number	Qty	Description
DSCL-KIT	1	Noritz Descale Kit includes: - 5 gal. bucket w/ lid (qty 1) - Submersible pump (qty 1) - 5 ft. hoses (qty 2)



MR-2

Commercial Multi-Rack System

Model Number	Qty	Description
MR-2	1	Commercial multi-rack system ¹

¹Fits 2 heaters, front and back
Refer to page 28 for complete accessories compatibility chart.



RC-#

Remote Controller

Model Number	Qty	Description
RC-7651M	1	Remote controller (all residential models)
RC-9018M	1	Commercial remote controller (Excluding NC380) / NRRC controller (For timer control)



QC-#

Quick Connect Cable

Model Number	Qty	Description
QC-1	1	Quick connect cable for NC380 ¹
QC-2	1	Quick connect cable (NR83, NR98, NRC111, NRC98, NCC199, NC199, EZ98, EZ111, NCC300, NRRC) ¹

¹Up to 2 units only



RB-#

Recess Box

Model Number	Qty	Description
RB-510	1	Recess box for NRC66, NR50, NR66, NRC71
RB-700-1	1	Recess box for NR98 and NR83
RB-900-1	1	Recess box for NRC111 and NRC98



RC-CORD#

Remote Controller Cord

Model Number	Qty	Description
RC-CORD10	1	10 feet in length
RC-CORD26	1	26 feet in length



SC-#

System Controller

Model Number	Qty	Description
SC-401-6M	1	System controller for up to 6 units for the NCC199, NCC300 & NC380 series
SCU-401-12M	1	System controller for up to 12 units for the NCC199, NCC300 & NC380 series
SCU-401-24M	1	System controller for up to 24 units for the NCC199, NCC300, & NC380 series
SC-401-6M-EXT	1	System controller for up to 6 units for the NC199



Accessories

NWC-ADAPTER

Wireless Adapter

Model Number	Qty	Description
NWC-ADAPTER	1	Wireless adapter (NAW-1 US) for current tankless models

*Not compatible with NRCC models.
Refer to page 29 for complete accessories compatibility chart.



MK-NRCB-1

Manifold Kit

Model Number	Qty	Description
MK-NRCB-1	1	Manifold kit for NRCC model



PVC Vent Accessories



PVC-#CT

PVC Concentric Horizontal Termination Kit

Model Number	Qty	Description	L1	L2	L3
PVC-2CT	1	2" PVC Concentric Termination	41"	7.38"	3.5"
PVC-3CT	1	3" PVC Concentric Termination	48"	8.75"	4.5"

Note:
For 4", use IPEX #196021

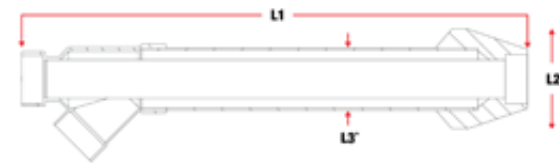

*Installation cutout should be at least 1/2" larger than dimension L3

DIAGRAM:
Horizontal Configuration

DIAGRAM:
Vertical Configuration

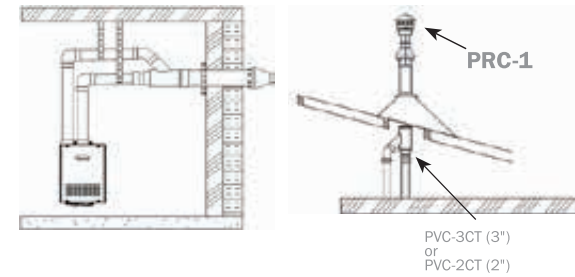

PVC-UCVK

Universal Concentric Vent Termination Kit

Model Number	Qty	Description	L1	L2	L3
PVC-UCVK	1	Universal Concentric Vent Termination Kit	31"	20"	4.5"



PVC-#LPT

Low Profile Vent

Model Number	Qty	Description	L1	L2
PVC-2LPT	1	Low Profile Vent (2")	2.37"	2.37"
PVC-3LPT	1	Low Profile Vent (3")	3.50"	3.38"

PVT-HL

Plastic Horizontal Termination

Model Number	Qty	Description	L1	L2
PVT-HL ²	6	2" PVC ²	7.5"	2.0"
PVT-HL ¹	6	3" PVC	7.5"	2.0"
PVT-HL ¹	6	4" PVC	7.5"	2.0"

¹ Not approved for Canada
² When using on 2" PVC, must use a 2" reducer

PVC Vent Accessories

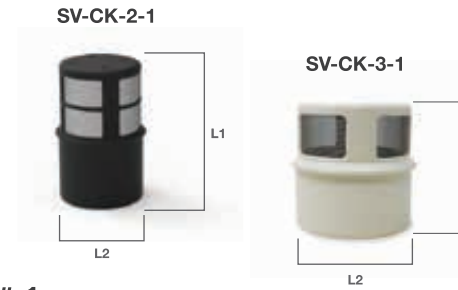

SV-CK-#-1

2" and 3" SV Conversion Kit

Model Number	Qty	Description	L1	L2
SV-CK-2-1	1	2" SV Conversion Kit	3.88"	2.37"
SV-CK-3-1	1	3" SV Conversion Kit	3.56"	3.48"

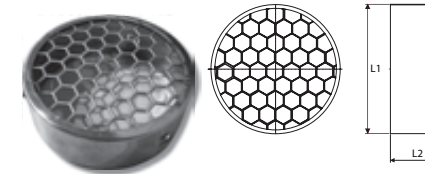

VT#-PVCS

PP or Stainless Steel Bird Screen for PVC Termination

Model Number	Qty	Description	L1	L2
VT2-PVCS	1	2" Polypropylene (White)	2"	3"
VT3-PVCS	1	3" Stainless Steel	2.8"	3"
VT4-PVCS	1	4" Stainless Steel	4.5"	3"



SV-CKM-23

DV to SV Conversion Kit

Model Number	Qty	Description
SV-CKM-23	1	2" or 3" (Screen Only)



PRC-1

Plastic Rain Cap

Model Number	Qty	Description	L1	L2
PRC-1 ²	1	2" (EZ98, EZ111, NCC199CDV)	7.7"	6.2"
PRC-1 ¹	1	3" (For NRC111, NCC199, NRC98, NRC71, NRC66, NRCB, & NCC199CDV)	7.7"	6.2"
PRC-1 ¹	1	4" (For NRC111, NCC199, NRC98, NCC300)	7.7"	6.2"

¹ Not approved for Canada
² Not approved for Canada; Needs 3"x2" bushing



VC-#

Outdoor Vent Cap

Model Number	Qty	Description	L1	L2
VC-6-1 ¹	1	Outdoor vent cap for DV Models (EZ, NRCR, and CDV)	10.9"	5.1"
VCK-NRCB	1	Outdoor conversion kit for DV models including NRCB boiler	10.4"	5.3"

VC-132	1	Outdoor vent cap for SV Model including NC380	18.9"	7.6"
--------	---	---	-------	------

¹ Not approved for Canada



CR#-PVC

Cosmetic Ring

Model Number	Qty	Description
CR3-PVC	1	3" Cosmetic ring for PVC
CR4-PVC	1	4" Cosmetic ring for PVC

Single Wall Vent

VP# - #STR

Rigid vent pipe stainless steel single-wall

Model Number	Qty	Venting Series	L1	L2
VP4-6STR	6	4" SUS	2.1"	6"
VP4-12STR	6	4" SUS	2.1"	12"
VP4-24STR	6	4" SUS	2.1"	24"
VP4-36STR	6	4" SUS	2.1"	36"
VP4-48STR	6	4" SUS	2.1"	48"
VP5-6STR	6	5" SUS	2.7"	6"
VP5-12STR	6	5" SUS	2.7"	12"
VP5-24STR	6	5" SUS	2.7"	24"
VP5-36STR	6	5" SUS	2.7"	36"
VP5-48STR	6	5" SUS	2.7"	48"

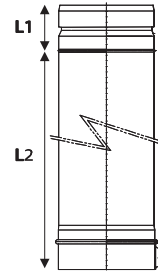

VP# - #ADJ

Adjustable vent pipe stainless steel single wall

Model Number	Qty	Venting Series	L1	L2
VP4-9.4ADJ	6	4" SUS	2.1"	6"
VP4-13.4ADJ	6	4" SUS	2.1"	12"
VP4-21.4ADJ	6	4" SUS	2.1"	24"
VP4-60ADJ	6	4" SUS	2.1"	36"
VP5-9.4ADJ	6	5" SUS	2.7"	48"
VP5-13.4ADJ	6	5" SUS	2.7"	6"
VP5-21.4ADJ	6	5" SUS	2.7"	12"

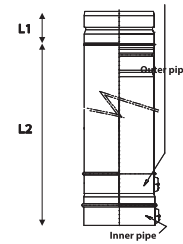

VP#-45ELB

45° Vent pipe elbow stainless steel single-wall

Model Number	Qty	Description	L1	L2
VP4-45ELB	6	4" SUS	2.1"	4.0"
VP5-45ELB	6	5" SUS	2.7"	5.4"

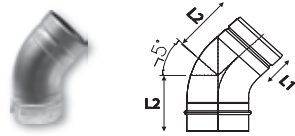

VP#-90ELB

90° Vent pipe elbow stainless steel single wall

Model Number	Qty	Description	L1	L2
VP4-90ELB	6	4" SUS	2.1"	6.2"
VP5-90ELB	6	5" SUS	2.7"	7.9"

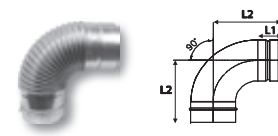

VP#-18FLEX

Semi-flexible vent pipe stainless steel single wall

Model Number	Qty	Description	L1	L2
VP4-18FLEX	6	4" SUS	2.1"	16.75"
VP5-18FLEX	6	5" SUS	2.1"	16.75"



4" SUS	For NR98SV
5" SUS	For NC380 Series
Concentric SUS	For DVC Series

Single Wall Vent Accessories

ARF#

Angled roof flashing stainless steel single-wall

Model Number	Qty	Description	L1	L2
ADJRF34 ²	1	4"¹	5.7"	14.3"
ARF5*	1	5" SUS	5.8"	7.8" - 14"
CARF-1*	1	Concentric SUS*	5.8"	7.8" - 14"

1Galvalume for ADJRF34
20-45 degree roof pitch

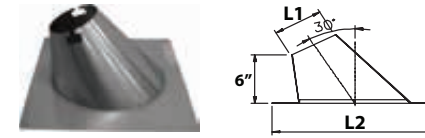

WT#

Vent pipe wall thimble stainless steel single-wall

Model Number	Qty	Description	L1	L2
WT4	1	4" SUS	10"	7"
WT5	1	5" SUS	12.2"	10.7"

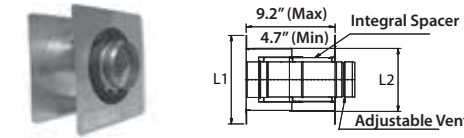

SS to PVC Vent Adapters

4" Adapter

Model Number	Qty	Description
VK4-PVC2SUS	1	Convert from 4" for PVC to 4" single-wall stainless steel venting
PVC4XVP5-ADAPT	1	4" for PVC to 5" stainless steel vent adapter (NCC300)



VT#-SH

Vent pipe termination w/ hood stainless steel single-wall vent pipe

Model Number	Qty	Description	L1	L2
VT4-SH	6	4" SUS	7.4"	6.1"
VT5-SH	6	5" SUS	7.4"	6.6"

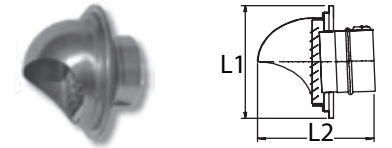

WT4-H-#

Adjustable wall thimble w/ termination stainless steel single-wall vent pipe

Model Number	Qty	Description	L1	L2
WT4-H-8-1	1	4" SUS	5.8"	4.1" - 7.8"
WT4-H-14-1	1	5" SUS	5.8"	7.8" - 14"

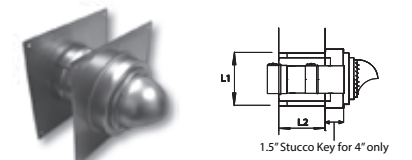

VP4-ADAPT-1

Appliance adapter vent pipe stainless steel single-wall

Model Number	Qty	Venting Series	L1	L2
VP4-ADAPT1	6	4" SUS	1.2"	4.9"

*Only used with non-Noritz units to use with our VP4 venting.

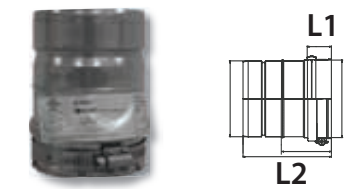

Single Wall Vent Accessories

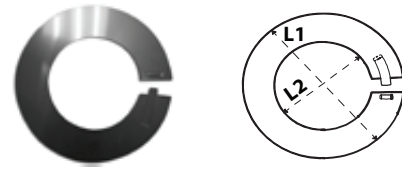

CR#

Stainless steel cosmetic ring

Model Number	Qty	Venting Series	L1	L2
CR4-SUS	1	4" SUS	7.2"	4.3"
CR5-SUS	1	Concentric and 5" SUS	9.9"	5.4"

FS#

Stainless steel fire stop

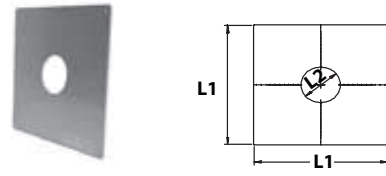

Model Number	Qty	Venting Series	L1	L2
FS4	6	4" SUS	18"	4.4"
FS5	6	5" SUS	20.4"	5.4"

SS5-#

5" and concentric SUS venting series stainless steel support straps

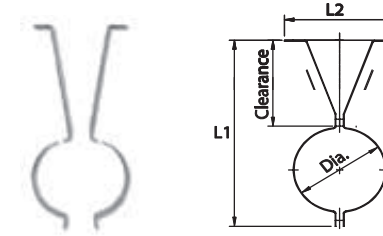

Model Number	Qty	Clearance	L1	L2
SS5-1	5 Sets	1"	6.8"	6"
SS5-2	5 Sets	2"	7.8"	6"
SS5-4	5 Sets	4"	9.8"	6"
SS5-6	5 Sets	6"	11.8"	6"

SS4-#

4" SUS venting series stainless steel support straps

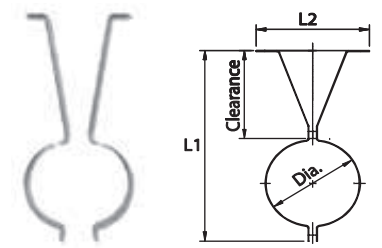

Model Number	Qty	Clearance	L1	L2
SS4-1	5 Sets	1"	5.7"	4.7"
SS4-2	5 Sets	2"	6.6"	4.7"
SS4-4	5 Sets	4"	8.7"	4.7"
SS4-6	5 Sets	6"	10.7"	4.7"

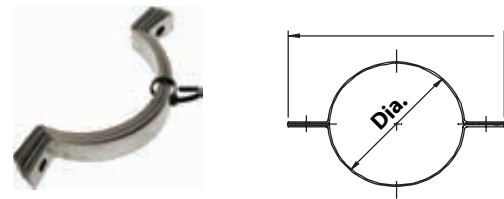

SC#

Stainless steel support clamp

Model Number	Qty	Venting Series	Diameter
SC4	5 Sets	4" SUS	6"
SC5	5 Sets	5" SUS	7"

SCR#

Storm Collar Ring

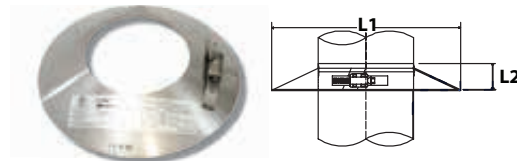

Model Number	Qty	Venting Series	L1	L2
SCR4-1	1	4"	9"	6"
CSCR-1	6	Concentric and 5" SUS	9.1"	4"

4" SUS	For NR98
5" SUS	For NC380 Series
Concentric SUS	For DVC Series

BG-DVC-#

Stainless steel bug guard



Model Number	Qty	Venting Series	Description
BG-DVC-H	1	Concentric SUS	Horizontal
BG-DVC-V	1	Concentric SUS	Vertical

Image and drawing shown: BG-DVC-V

FP-5-OUT

Stainless steel face plates



Model Number	Qty	Venting Series	L1	L2
FP-5-OUT	1	Concentric SUS	6.7"	8.7"

4" SUS	For NR98
5" SUS	For NC380 Series
Concentric SUS	For DVC Series

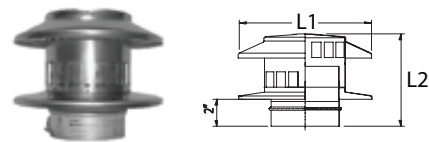

RC#

Venting Pipe Rain Cap

Model Number	Qty	Venting Series	L1	L2
RC4	6	4" SUS	7.8"	6.6"

Single Wall Vent Kits

Concentric Venting

N-Vent Vertical Vent Kit VK4-V1

Vertical Kit Contains:

Description	Part Number	Quantity
Drain Tee	DT4	1
90 Degree Elbow	VP4-90ELB	2
Firestop	FS4	1
Support Clamp	SC4	1
Roof Jack	RJ4	1
Storm Collar Pipe	SCP4	1
Rain Cap	RC4	1
9"- 13.4" Adjustable Vent	VP4-13.4ADJ	1

SV

VK4-V1

Vent Pipe Vertical Kit (Stainless steel single wall)

Model Number	Qty	Venting Series
VK4-V1	1	4" SUS

N-Vent Horizontal Vent Kit VK4-H-*

Horizontal Kit Contains:

Description	Part Number	Quantity
Wall Thimble with Built-in Hood Termination	WT4-H-#-1 (# Based on wall thickness)	1
Vertical Adjustment Range (7.5" - 11")	VP4-90ADJELB	1

Wall Thickness	Venting Kit Number
4.1" - 7.4"	VK4-H-8-1
7.4" - 14"	VK4-H-14-1

SV

VK4-H-#-1

Vent Pipe Horizontal Kit (Stainless steel single wall)

Model Number	Qty	Venting Series
VK4-H-8-1	1	4" SUS ¹

VK4-H-14-1	1	4" SUS ²
------------	---	---------------------

1 4.1 - 7.4" Wall thickness
2 7.4 - 14" Wall thickness

4" SUS	For NR98
--------	----------

CVP-#STR

Rigid vent pipe stainless steel double-wall

Model Number	Qty	Venting Series	L1
CVP-4STR	5 Sets	Concentric SUS	3.3"
CVP-12STR	5 Sets	Concentric SUS	11.8"
CVP-24STR	5 Sets	Concentric SUS	23.6"
CVP-36STR	5 Sets	Concentric SUS	35.4"

CVP-45ELB

45° Vent pipe elbow - Stainless steel double-wall

Model Number	Qty	Venting Series	L1	L2
CVP-45ELB ¹	6	Concentric SUS	5.3"	2.2"

1 Non-Flexible

CVP-90ADJELB

90° Adjustable vent pipe elbow - Stainless steel double-wall

Model Number	Qty	Venting Series	L1	L2
CVP-90ADJELB	6	Concentric SUS	12.6 - 15.8"	4.9"

CVP-#ADJ

Adjustable vent pipe stainless steel double-wall

Model Number	Qty	Venting Series	L1
CVP-11ADJ	6	Concentric SUS	8.3 - 11.2"
CVP-16ADJ	6	Concentric SUS	11 - 16.7"
CVP-40ADJ	6	Concentric SUS	22.8 - 40.6"

CVP-90ELB

90° Vent pipe elbow - Stainless steel double-wall

Model Number	Qty	Venting Series	L1	L2
CVP-90ELB ¹	6	Concentric SUS	8.1"	4.9"

1 Non-Flexible

CWF-90ELB

90° Adjustable vent pipe elbow w/ wall flange - Stainless steel double-wall

Model Number	Qty	Venting Series	L1	L2
CWF-90ELB	6	Concentric SUS	12.6 - 15.8"	4.9"

Concentric SUS	For DVC Series
----------------	----------------

Concentric Venting

Concentric Vent Kits

CRCAI-1-F

Vent pipe rain cap - Stainless steel double-wall

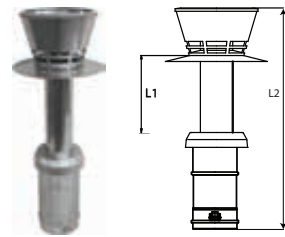

Model Number	Qty	Venting Series	L1	L2
CRCAI-1-F	1	Concentric SUS	10.6"	26.5"

CWF-F

Vent pipe w/ wall flange - Stainless steel double-wall



Model Number	Qty	Venting Series	L1	L2
CWF-F	6	Concentric SUS	2"	8.7"

CVT-S

Straight termination w/ bird screen - Stainless steel double-wall vent pipe

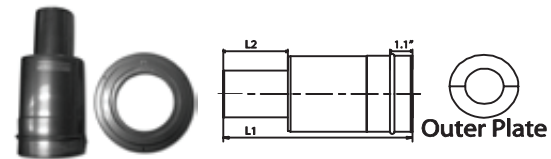

Model Number	Qty	Venting Series	L1	L2
CVT-S	6	Concentric SUS	11"	3.9"

CWT-H

Builder's edition wall thimble - Galvalume double-wall vent pipe



Model Number	Qty	Venting Series	L1	L2
CWT-H	1	Concentric	Min 3.5"	1.5"

Horizontal - Kits

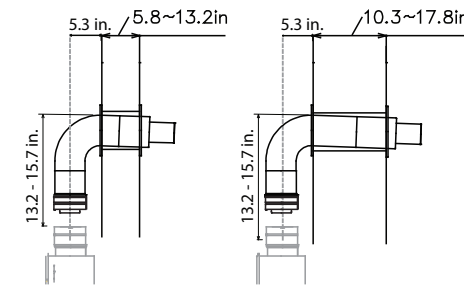

Standard Wall Kit
Includes inner & outer plates
CVK-H-F
Wall Thickness Range
From 5.8"-13.2"

Thick Wall Kit
Includes inner & outer plates
CVK-H2-F
Wall Thickness Range
From 10.3"-17.8"

Horizontal - Build your own

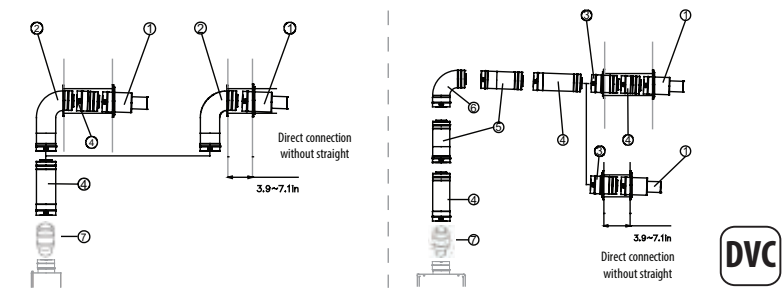

No	1	2	3	4	5	6	7
Description	Straight Bird Screen w/ Outer Plate	90° Adj w/ Wall Flange	Straight Vent Pipe w/ Wall Flange	Straight	Adjustable	45/90 Degree	M2M
Part Number	CVT-S	CWF-90ELB	CWF-F	CVP-4/12/24/36STR	CVP-11/16/40ADJ	CVP-45/90ELB	CVP-ADAPT-M2M

CVK-H-F

Vent pipe horizontal kit - Stainless steel double-wall

Model Number	Qty	Venting Series	L1
CVK-H-F	1	Concentric SUS ¹	8.3 - 11.2"

CVK-H2-F	1	Concentric SUS ²	11 - 16.7"
----------	---	-----------------------------	------------

1 (5.8 - 13.2" Wall thickness)
2 (10.3 - 17.8" Wall thickness)

Note the venting has changed. Before installation, confirm the termination piece ordered on the table below. If a vent termination piece from the "Existing Vent Kit" column is being utilized, a CVP-ADAPT-M2M (Fig 1) adapter must be utilized. If a vent termination from the "New Vent Kit" column is utilized, no adapter is necessary.

	Existing Vent Kit	New Vent Kit
Horizontal	CVK-H CVK-H2 CWF	CVK-H-F CVK-H2-F CWF-F
Vertical	CRCAI-1 CVK-V-1	CRCAI-1-F CVK-V-1-F

CVP-ADAPT-M2M

Concentric vent pipe male to male - stainless steel double-wall

Model Number	Qty	Venting Series	L1	L2
CVP-ADAPT-M2M	1	Concentric	5"	5.5"

Note the venting has changed. Before installation, confirm the unit ordered on the table below. If a vent termination piece from the "Existing Unit" column is being utilized, a CVP-ADAPT-F2F (Fig 1) adapter must be utilized. If a vent termination from the "New Unit" column is utilized, no adapter is necessary.

Existing Unit	New Unit
NR83-DVC NR98-DVC NR981-DVC NC199-DVC NC1991-DVC	NR83DVC (GQ-2457WS-FFA US) NR98DVC (GQ-2857WX-FFA US) NC199DVC (GQ-2857WZ-FFA US)

CVP-ADAPT-F2F

Concentric vent pipe adapter female to female - stainless steel double-wall

Model Number	Qty	Venting Series	L1	L2
CVP-ADAPT-F2F	1	Concentric	5"	7.5"

Prior heater models. Version 2 venting.

Concentric SUS	For DVC Series
----------------	----------------

HORIZONTAL INSTALLATIONS

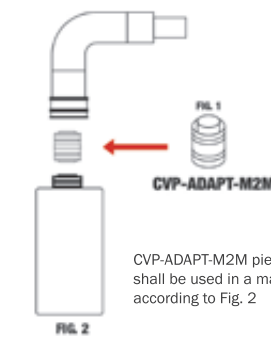

CVP-ADAPT-M2M piece shall be used in a manner according to Fig. 2

VERTICAL INSTALLATIONS

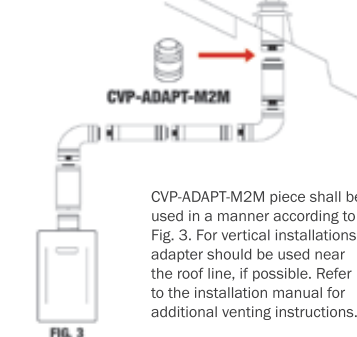

CVP-ADAPT-M2M piece shall be used in a manner according to Fig. 3. For vertical installations, adapter should be used near the roof line, if possible. Refer to the installation manual for additional venting instructions.

HORIZONTAL INSTALLATIONS

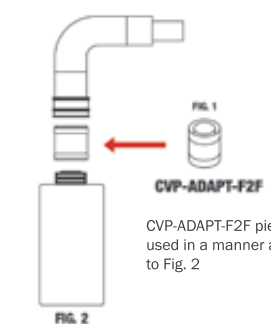

CVP-ADAPT-F2F piece shall be used in a manner according to Fig. 2

VERTICAL INSTALLATIONS

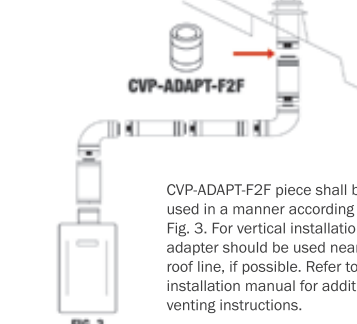

CVP-ADAPT-F2F piece shall be used in a manner according to Fig. 3. For vertical installations, adapter should be used near the roof line, if possible. Refer to the installation manual for additional venting instructions.

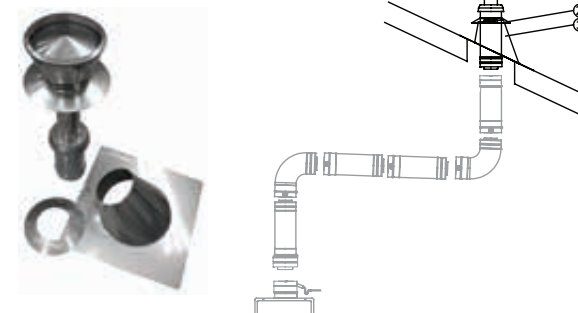

CVK-V-1-F Contents		
No	Description	Part Number
1	Concentric Rain Cap	CRCAI-1-F
2	Storm Collar	CSCR-1
3	Adjustable Roof Flashing (0-45 Degrees)	CARF-1



CVK-V-1-F

Vent pipe vertical kit - Stainless steel double-wall

Model Number	Qty	Venting Series
CVK-V-1-F	1	Concentric SUS ¹

¹10-45° Roof Pitch

Snorkel Kit

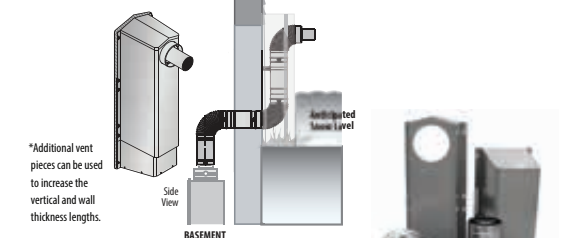

*Additional vent pieces can be used to increase the vertical and wall thickness lengths.

Snorkel Kit (CVK-SNRK) Contents		
PCS	Description	Part #
1	Snorkel case top	SNRK-C1
2	Snorkel case bottom	SNRK-C2
3	Concentric 11" adjustable vent pipe	CVP-11ADJ
4	Concentric 18" adjustable vent pipe	CVP-18ADJ
5	Concentric snorkel termination elbow	CVP-SNRK-90ELB
6	Concentric 90 degree elbow	CVP-90ELB
7	Concentric 90 degree adjustable elbow	CVP-90ADJELB
8	Adjustable support strap	SSS-3ADJ
9	Screw set	S-12
10	Concentric vent pipe, male to male	CVP-ADAPT-M2M



CVK-SNRK-F

Vent pipe horizontal snorkel kit - Stainless steel double-wall

Model Number	Qty	Venting Series
CVK-SNRK-F	1	Concentric SUS

Support Site and Parts Ordering

Get Certified Parts For Any Noritz Repair. Period.

Our newly redesigned support page is your go-to source for all technical specs and support documents for all Noritz tankless water heaters.

One of the biggest updates we're excited to share is the addition of parts ordering online! Find all the parts you need, available 24/7 to order. Stock your truck with all those necessary parts today!

Visit Support.Noritz.com



Take Your Business To The Next Level

Premium ProCard subscription provided by Service Whale®

Features & Benefits



Parts Ordering Online

Get the parts you need 24/7. Our new parts ordering feature saves time and minimizes waiting when you need it most. Keep your parts stocked and ready for any scenario.



Technical Literature

Our technical literature page offers owners a vast library of documents for each heater including spec sheets, owner's guides, install manuals, parts lists, and certification documents.



Part Search Tool

Allows you to search for parts easily. Access a complete overview of technical spec info, installation, accessories, approvals, & warranty.



Warranty Calculator

This calculator is designed to approximate the length of your warranty terms. Now more precise when you add an installation date or maintenance monitor data.



Get started today at Training.Noritz.com

Hone Your Craft

Noritz prides itself in providing our installers all the tools necessary to make every install a great one. Noritz University provides a library of resources available online, along with live virtual events on a number of products and topics every week.

In addition, Noritz online training courses are available to everyone who wants to learn more about the ins and outs of our tankless water heaters at their own pace. From domestic units to combination boilers, our courses are designed to deepen your knowledge of Noritz tankless technology.

Available Online Courses Include:

- R1 and R2 training
- Condensing Models
- NRCR tankless model with pump
- EZ Series / EZTR bundles
- Combination boilers

Cursos en Español Ahora Disponible!

El entrenamiento Residencial R1 es el mejor lugar para comenzar a aprender sobre los calentadores de agua sin tanque Noritz

Need an in-person training for your team?

Scan to request a live training at your jobsite with a Noritz professional. We offer 3 training classes for installers:

Level 1 -
Basic Maintenance and Proper Installation

Level 2 -
Maintenance, Troubleshooting, and Teardown

Level 3 -
Tankless Teardown

Our Newest Program for Contractors - ProCard Plus!

Noritz is excited to introduce **ProCard+**! Available as an upgrade to our existing ProCard, this new subscription-based program brings you even more qualified leads as well as tools to expand your business with Noritz, the industry's most trusted line of tankless water heaters.

ProCard+ brings even more benefits to contractors looking to expand their business and service even more customers in their area.

	PROCARD	PROCARD +
Get Listed on our Contractor Finder	✓	✓
Register Warranties	✓	✓
Get Leads	✓	✓
Advanced Business Profile	-	✓
Higher Ranking on Contractor Finder	-	✓
Improved Lead Retrieval System	-	✓
Customize Prequalifying Questions for Customers	-	✓

Features & Benefits



Get More Leads

With ProCard+, installers receive even more qualified leads, thanks to our new and improved lead retrieval system.



Business Profile +

ProCard+ users enjoy access to our Business Profile Plus, a customizable profile page with additional pictures, reviews and business information.



Custom Prequalifying Questions

Gain quick access to customer information with customizable questionnaires and photo submissions.



Rise to the Top

Our ProCard+ users automatically place higher in our 'Find an Installer' page, giving your business more leads in your area.

To register or to get more information about our ProCard+ program, email us at ProPlus@Noritz.com

Trailblazers in the field of Tankless Water Heating



Noritz is on the forefront of the tankless industry by pushing the limits of our technology to develop the most reliable and efficient products on the market. Combined with our world-class customer service, Noritz is the first choice in tankless water heating, giving installers peace of mind when choosing a tank replacement.



11160 Grace Avenue
Fountain Valley, CA 92708

Phone:
1-866-766-7489

Tech Support Hours:
Monday - Friday
5am - 6pm PST
Saturday
6am - 3pm PST

Follow us on social media
@NORITZAMERICA

