

2026 Product Guide

Residential and Commercial Water Heating Solutions



NEW FOR 2026

PRO

UPGRADED LINEUP



Noritz Flagship Products

- 4 Featured Product: EZ Series Pro
- 8 EZTR Bundles
- 10 NRCR Recirculating Tankless
- 14 NRCB Combination Boiler
- 15 EcoTough Heat Pump
- 16 Hybrid Hot Series
- 18 CMK/CRK Quick Commercial Manifold & Rack Kits
- 20 Commercial Rack Systems
- 22 TTS Synergy Series

Technical Specs

- 24 High Efficiency Models
- 26 Mid Efficiency / Commercial Models
- 28 Temperature Rise / Gas Sizing Charts

Accessories

- 30 Accessory Compatibility Chart
- 31 Accessories
- 34 PVC Vent Accessories
- 36 Single Wall Vent
- 37 Single Wall Vent Accessories
- 39 Single Wall Vent Kits
- 40 Concentric Venting
- 42 Concentric Vent Kits



**Over 70 years
in the field of
hot water heating.**

Noritz has been an innovator in the water heating industry for over 70 years. We introduced the first modern, electronically controlled tankless water heaters in 1981 and we remain the leader in energy savings and superior hot water delivery today.

Serving both homeowners & commercial users across the U.S. and Canada, Noritz America offers a broad range of water heating solutions to meet the varying needs of its broad spectrum of customers.



EZ SERIES PRO

The Top Tankless™

Meet the new EZ Series Pro — same trusted performance, smarter control. A new full function display streamlines installation and gives you greater visibility and control over your system. Paired with an unmatched 25 year warranty, ultra-high efficiency, and Bluetooth® connectivity, the EZ Series Pro line continues to set the standard for fast, reliable hot water delivery.

Pro Features

NEW Digital Control Panel

The EZ Series Pro now features an upgraded full function display for maximum visibility of operating status and additional heater functions.

Greater Efficiency

Our EZ Series Pro line offers an industry-leading **0.98 UEF RATING**, making it even more efficient than previous models by generating less harmful emissions.

Latch Cover Design

The new latch cover design now provides quick and easy access to internal parts and components.

The BEST Tankless Warranty on the Market

Noritz offers a 25 year warranty exclusively for our EZ Series Pro, leading the market with the best tankless warranty available.

Bluetooth® Connectivity

All EZ Series Pro models come equipped with Bluetooth® connectivity, providing more control of heater functions including temperature settings, timers, and more.

Available in One Gas Type

Natural Gas (NG) is the default gas type on our EZ Series Pro but if liquid propane (LP) is preferred, all units come with a gas conversion kit that helps to easily update your unit's gas type.



Install Your Way

The EZ Series Pro adapts to any installation scenario with a full range of venting options for both indoor and outdoor applications.

Direct Vent (Indoor)	Flex Vent (Indoor)	No Roof Kit	Single Vent (Indoor)	Outdoor
PVC-2CT (2" PVC) PVC-3CT (3" PVC) Direct vent utilizing 2 or 3" PVC	EZ2FVK-1 EZ2FVK-2-1 25 / 35' Flex Vent Conversion Kit	NRK-1 No-Roof Kit	SV-CK-2-1 2" Conversion Kit	VC-6-1 Outdoor Vent Cap

New For 2026 Upgraded Control Panel

Noritz is excited to introduce our upgraded EZ Series Pro line for 2026, which include enhanced monitoring capabilities thanks to our newly upgraded display panel. This update allows users to track system performance directly at the unit or remotely via Bluetooth® connectivity and provide greater operational visibility while maintaining the high-performance standards of our EZ Series Pro.

- Fast And Easy Setup Process**
Stay on top of your annual required maintenance by setting reminders directly through the control panel.
- Maintenance Reminders**
Get your EZ Series Pro up and running quickly thanks to our streamlined setup using our upgraded display.
- Easy Recirculation Scheduling**
Pairing your EZ Pro with our recirculation pump kit (RPK-EXT-P) and setting run times has never been easier thanks to our full function display.
- View Status And Error History**
Owners can now view real-time status and past errors of their unit directly through the control panel settings.



Technical Specs



Model Number	EZ71DV Pro	EZ98DV Pro	EZ111DV Pro
GQ Reference Number	GQ-C2661WX-FF-1 US NG	GQ-C2861WX-FF-1 US NG	GQ-C3261WX-FF-1 US NG
Min / Max BTU	12,800 - 160,000	12,800 - 180,000	12,800 - 199,900
Min. / Max. Flow Rate	0.4 - 7.1 GPM	0.4 - 9.8 GPM	0.4 - 11.1 GPM
UEF	0.98 UEF		
Max. Hot Water Capacity	30° Rise: 9.0 GPM	30° Rise: 9.8 GPM	30° Rise: 11.1 GPM
Dimensions	18.1" (w) x 26.1" (h) x 11.8" (d)		
Weight	62 pounds		
Connection Sizes	Water Inlet	NPT 3/4"	
	Hot Water Outlet	NPT 3/4"	
	Gas Inlet	NPT 3/4"	
	Condensate Drain	NPT 1/2"	
Temperature Settings	F° Mode	100 - 140° F (In 5° Intervals) (9 options)	
	C° Mode	37 - 48° C (In 1° intervals), 50-60° C (In 5° intervals) (15 options)	
Freeze Protection	Indoor: -30°F / Outdoor: -4° F		
Warranty	25 year heat exchanger warranty / 5 year warranty on parts / 1 year reasonable labor		
Bluetooth® Compatible	Yes		
Venting Lengths	2" PVC (75 feet), 3" PVC (150 feet), 4" PVC (65 feet)		
Hydrogen Compatible	Yes		
Installation	Indoor / Outdoor (with VC-6-1 vent cap)		
Pump Kit Compatible	Yes		
Bundle Options			
Bundle Available	N/A	Yes (EZTR50)	Yes (EZTR75)

Additional Features

Top Mounted Water Connections

Top mounted connections allow for previous water lines to be reconnected faster.

Hydrogen Ready

The EZ Series Pro is our first tankless to offer Hydrogen compatibility, which further reduces harmful emissions.

Dual High Grade Stainless Steel Heat Exchangers

Featuring greater resistance to corrosion and buildup, keeping your system running for years to come.

1/2" Gas Line Compatible

Compatible with most installations, the 3/4" fitting is found underneath the unit for a more convenient install.

Steady BTU Mode

SBTU mode eliminates issues with high incoming water temperature in the summer by reducing effective BTU output to less than 5 KBTU, preventing water temperature fluctuations while keeping your tankless running efficiently.

Accessories

Install It Your Way

The Noritz EZ Series Pro adapts to your installation needs, providing professional installers and their homeowner-customers with a wider range of tankless options, covering the majority of residential, tank-replacement opportunities. Choose the way you install the EZ71, EZ98 or EZ111 with any of these available accessories. Tackle a wide variety of install scenarios with the most versatile tankless on the market.

SPK-EZ5

Pro Service Kit

Our latest Pro service kit comes with a variety of parts and components to help with maintenance of our latest Pro line of units.



Part Number	Description	Qty
FABH001	High Limit Switch - 194 (GQ59EZ, GQ60EZ/NRCR)	1
FHCH010	High Limit Switch - 194 (GQ61EZ/NRCR, GQ61-1EZ/NRCR)	1
FAQH001	High Limit Switch - 198 (GQ59NCC, GQ60NCC)	1
FHDH001	High Limit Switch - 198 (GQ61NCC, GQ61-1NCC)	1
FAQH002	High Limit Switch - 221 (All NCC)	1
FABH002	High Limit Switch - 320 (All GQ59)	1
SKJ730E	Igniter Set w/ Wires & Sleeve (All GQ59)	1
SKJ72Y9	Igniter (Set) (All GQ60)	1
SKJ745E	Igniter w/ Ignition Plug (Set) (All GQ61, All GQ-61-1)	1
SKJ7411	Igniter (Set) (All GQ61, All GQ-61-1)	1
SKJ71VZ	Ignition Plug w/ Gasket (All GQ59)	1
SKJ72MT	Ignition Plug w/ Gasket (All GQ60)	1
SKJ7412	Ignition Plug w/ Gasket (Set) (All GQ61, All GQ-61-1)	1
SKJ72N1	O-Ring Kit (All Models)	1
SKJ72N0	Screw Kit (All Models)	1
SKJ73XX	Screw Kit (All Models)	1
EGBD032	Water Filter (All Models)	3
FFSD032	Water Filter (All Models)	3
DTJD006	Water Filter Cap (All Models)	3
EPAD001	Water Flow Sensor (Set) (All GQ59, GQ60NCC)	1
EDGD101	Water Flow Sensor (Set) (GQ60EZ/NRCR)	1
EGGD037	Water Flow Sensor (Set) (GQ60NRCR)	1
FHCD041	Water Flow Sensor (Set) (GQ61EZ/NRCR, GQ61-1EZ/NRCR)	1
FHED031	Water Flow Sensor (Set) (GQ61NRCR, GQ61-1NRCR)	1
EPAD002	Water Flow Sensor (Set) (GQ61NCC, GQ61-1NCC)	1
ETFD051	Water Servo - Main (Set) (All GQ59, GQ60NCC)	1
FBMD011	Water Servo - Main (Set) (GQ60EZ/NRCR)	1
FCDD214	Water Servo - Main (Set) (GQ61NCC, GQ61-1NCC)	1
FHCD051	Water Servo (Set) (GQ61EZ/NRCR, GQ61-1EZ/NRCR)	1
ETFD050	Water Servo - Bypass (Set) (All GQ59, ALL GQ60, GQ61NCC, GQ61-1NCC)	1

NRK-1

No Roof Kit

The Noritz No-Roof Kit provides a new venting option by eliminating the need to climb onto the rooftop to complete your installation. The kit also comes with all materials needed, cutting down further install time and material waste.

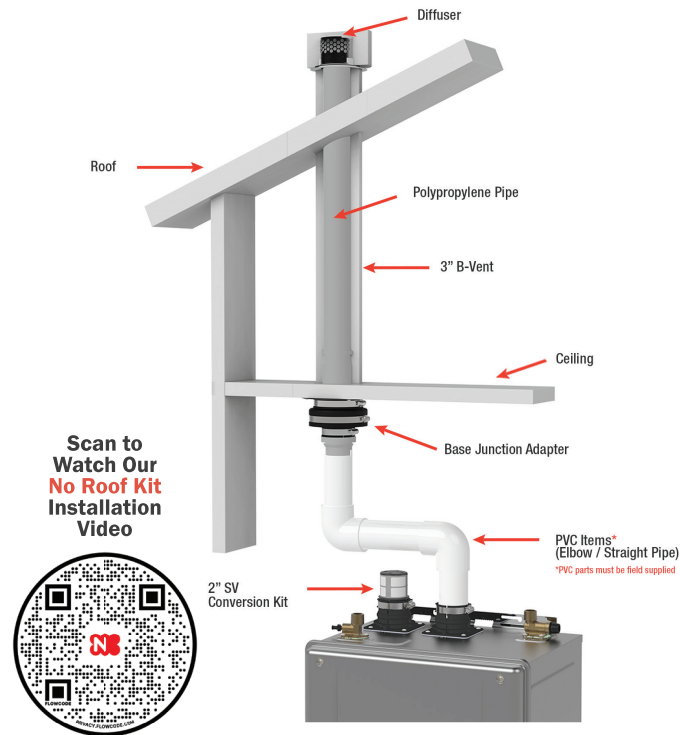

Scan to Watch Our No Roof Kit Installation Video



Venting Accessories



Single Vent 2" SV Conversion Kit SV-CK-2-1

Our 2" single vent conversion kit upgrades direct vent (DV) installs to non-direct vent (SV) operation.



Outdoor Installation Outdoor Vent Cap VC-6-1

The Outdoor Vent Kit allows for outdoor installations of your EZ Series Pro tankless. Our new plastic outdoor vent cap is now easier to install and features a new elegant design.



Direct Vent Utilizing 2" PVC PVC-2CT (2" PVC) PVC-3CT (3" PVC)

Additional Optional Accessories:
PVC concentric horizontal termination kit

EZ SERIES^{PRO} Flex Vent Kits

Available in both 25 and 35 feet, our flex vent kits are designed to bring homeowners more installation versatility and come with all the necessary parts making it easy to install the Noritz EZ Series Pro of your choice.

25 Feet EZTR 2" Flex Vent Kit

Accessories required for this install:

EZ2FVK-1

Bag 1



- Flex Feeder
- Base Junction Support
- Base Junction Adapter

Bag 2



- Top Flex Support
- Rain Cap

Bag 3



- Rigid 45° Elbow
- 2" Flex Vent Gasket



- 25 Feet of 2" Flex Vent

25 ft. Flex Vent Included

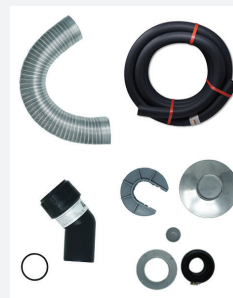

EZ2-CK-1

Required To Utilize Flex Vent Kits For EZ Series Pro and NRCR



Flex Vent 2" Conversion Kit

Optional Accessory

Optional Diffuser Kit (For use if keeping existing rain cap)

EZ2-DK-1 (25')

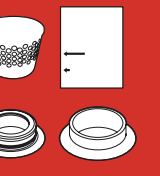

Install Through Existing B-Vent Up To 25 Feet (Optional, Sold Separately)

35 Feet EZTR 2" Flex Vent Kit

Accessories required for this install:

EZ2FVK-2-1

Bag 1



- Flex Feeder
- Base Junction Support
- Base Junction Adapter

Bag 2



- Top Flex Support
- Rain Cap

Bag 3



- Coupler Retainer
- 2" Flex Vent Gasket
- O-Ring Lubricant
- 45° Elbow



- 35 Foot 2" Flex Vent

35 ft. Flex Vent Included



EZ2-CK-1

Required To Utilize Flex Vent Kits For EZ Series Pro and NRCR



Flex Vent 2" Conversion Kit

Optional Accessory

Optional Diffuser Kit (For use if keeping existing rain cap)

EZ2-DK-2 (35')

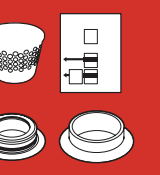

Install Through Existing B-Vent Up To 35 Feet (Optional, Sold Separately)

EZ START PLUS[®]

Mobile app for iOS and Android

Our new EZ Start Plus[®] app gives users more control of their tankless water heater functions via Bluetooth[®]:

- Update Temperature Settings
- Program Recirculation Scheduling
- Quick Initial Setup Process
- Tools for Quick and Easy Maintenance
- Easily Switch Between Recirculation Modes
- Check Unit Status and Error Codes
- Recordable Maintenance Monitors for Quicker Troubleshooting
- Quick Links on Error Codes
- Trial Operation for Parts
- Ability to Copy and Save Unit Settings for Faster Unit Set Up



Scan Here to Download the EZ Start Plus[®] app

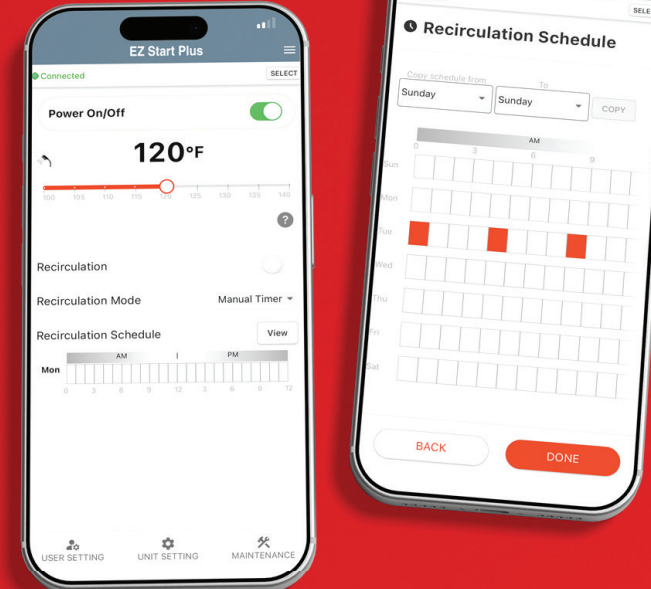

EZTR PRO Bundles

All-In-One Residential Tank Replacement Bundles

The Noritz EZTR Pro bundles include select accessories to help speed up installation and get your home's hot water up and running. In addition, our EZTR50 and EZTR75 bundles have now been updated to our latest **EZ Series Pro** models, providing homeowners with the latest and greatest iteration of our award-winning flagship tankless.

Ideal for Medium-Sized Homes

EZTR50

50 GALLON TANK REPLACEMENT

- EZ98 Pro Tankless Water Heater
- Isolation Valves / PRV
- Flex Vent Conversion Kit
- Flex Feeder w/ Base Junction Support and Adapter
- Top Flex Support Rain Cap
- Aluminum Flex Sleeve
- Polypropylene Flex Vent (25 ft.)



Ideal for Larger Homes

EZTR75

75 GALLON TANK REPLACEMENT

- EZ111 Pro Tankless Water Heater
- Isolation Valves / PRV
- Flex Vent Conversion Kit
- Flex Feeder w/ Base Junction Support and Adapter
- Top Flex Support Rain Cap
- Aluminum Flex Sleeve
- Polypropylene Flex Vent (25 ft.)

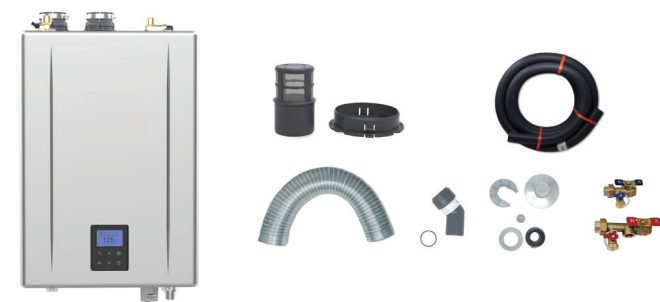

Also Available

EZTR40

40 Gallon Tankless Bundle

The EZTR40 package is designed for quick and direct indoor replacement of 40-gallon tank water heaters.

All Parts Needed for Installation Included

Each EZTR50 and EZTR75 Pro bundle includes the heater itself, a flex vent conversion kit (25 feet of 2-inch flex), an isolation valve kit, and a startup guide. The EZTR40 also comes with a heater, vent kit, and service valves.

Technical Specifications

Vents Through Existing, Round 3" Or 4" B-Vent



Model Number	EZTR40	EZTR50	EZTR75
GQ Reference Number	GQ-C1956WS-F US	EGQ-C2861WX-FF-1 US NG	EGQ-C3261WX-FF-1 US NG
Vent Type	2" Flex Vent	Convertible Vent	Convertible Vent
Dimensions (Inches)	27.2"(h) x 18.3"(w) x 9.4"(d)	26.1"(h) x 18.1"(w) x 11.8"(d)	26.1"(h) x 18.1"(w) x 11.8"(d)
Weight (lbs)	50 lbs.	62 lbs.	62 lbs.
Min. / Max. BTUh	15,000 - 120,000 BTU/h	12,800 - 180,000 BTU/h	12,800 - 199,900 BTU/h
UEF	0.87	0.98	0.98
Max. Hot Water Capacity	6.6 GPM	9.8 GPM	11.1 GPM
Water Inlet	3/4"		
Hot Water Outlet	3/4"		
Gas Inlet (1/2 in. capable)	1/2" (1/2 in. up to 100 ft.)	3/4" (1/2 in. up to 50 ft.)	3/4" (1/2 in. up to 40 ft.)
Temp. Settings	115 - 140°F (In 5° Intervals)	100-140°F (In 5° intervals) (9 Options)	
Warranty	12 year warranty on heat exchanger, 5 year warranty on parts, & 1 year reasonable labor	INDUSTRY LEADING 25 YEAR HEAT EXCHANGER WARRANTY 5 year warranty on parts & 1 year reasonable labor	
Ultra Low NOx	Yes		
Quick Connect	No	Yes	
Remote Included	Digital Display	Built-in Display	
Min. / Max. Flow Rate	0.5 GPM / 6.6 GPM	0.4 GPM / 9.8 GPM	0.4 GPM / 11.1 GPM
High Altitude Approved	Up to 3,500 ft.	Up to 10,200 ft.	
Bluetooth® Compatible	No; Wifi Only	Yes	
Pump Kit Compatible	No	Yes	
EZTR / EZ Series Options			
Bundle	Yes (Model EZTR40)	Yes (Model EZTR50)	Yes (Model EZTR75)
Sold Separately	No	Yes (Model EZ98; GQ-C2861WX-FF-1 US NG)	Yes (Model EZ111; GQ-C3261WX-FF-1 US NG)

NORITZ® NRCR PRO

The NRCR Pro line now takes our best-selling recirculating tankless and gives it a spec boost thanks to the newly upgraded full function display, which provides a smoother setup process, maximum visibility of heater status, and more. In addition, the NRCR Pro continues to provide improved efficiency, Bluetooth® connectivity, and the best warranty for a recirculating tankless. These upgrades make our NRCR Pro the first choice for homeowners looking for faster, reliable hot water delivery with recirculation.

Pro Features

- ➔ **New Digital Control Panel** The new control panel upgrade now features a larger display and gives homeowners and contractors more visibility of heater updates and functions.
- ➔ **Industry-Leading 15 Year Warranty** The NRCR Pro comes with a 15 year warranty on its heat exchangers - one of the best warranties on a tankless with an integrated recirculation pump.
- ➔ **Greater Efficiency** An improved **0.98 UEF RATING** makes our NRCR Pro even more efficient than previous models while generating less harmful emissions.
- ➔ **Bluetooth® Connectivity** All NRCR Pro models come equipped with Bluetooth® connectivity, providing users with more control of heater functions including pump timers, temperature settings, and more.
- ➔ **Available in One Gas Type** Natural Gas (NG) is the default gas type on all NRCR Pro models but if liquid propane (LP) is preferred, all units come with a gas conversion kit that helps to easily update your unit's gas type.
- ➔ **Latch Cover Design** The new latch cover design now provides quick and easy access to internal parts and components.

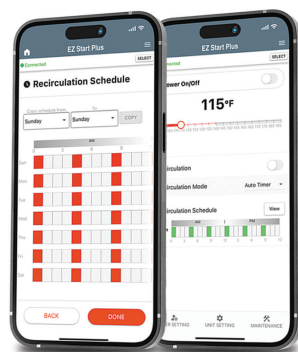

EZ START PLUS®

App Highlight:
Bluetooth® Control

Our new EZ Start Plus® app allows users more control of heater functions including recirculation pump timers, temperature settings, and more.



Pump Comes Integrated

The NRCR Pro uses a fully integrated **ECM pump** to keep hot water close to even the farthest outlet in the home, minimizing the wait and, therefore, the waste of unused potable water down the drain.

New For 2026 Upgraded Control Panel

More control. More visibility. Same Pro performance. Noritz's NRCR Pro upgrade features an enhanced display panel for real-time system monitoring – at the unit or remotely via Bluetooth®. The result: deeper operational visibility, backed by the same high-performance standards you expect from the NRCR Pro line.

- ➔ **Fast And Easy Setup Process** Get your NRCR Pro up and running quickly thanks to our streamlined setup using the new control panel.
- ➔ **Maintenance Reminders** Set maintenance reminders right from the control panel – so you never miss an annual service.
- ➔ **Easy Recirculation Scheduling** Scheduling your recirculation run times is now a breeze thanks to the upgraded process in our new control panel.
- ➔ **View Status And Error History** Owners can now view real-time status and past errors of their unit directly through the control panel settings.



Technical Specs

Model Number	NRCR92DV	NRCR111DV
GQ Reference Number	GQ-C2661WXQ-FF-1 US	GQ-C3261WXQ-FF-1 US
Min. / Max. BTU/h	12,800 - 165,000 BTU/h	12,800 - 199,900 BTU/h
Min. / Max Flow Rate	0.4 - 9.2 GPM	0.4 - 11.1 GPM
UEF	0.98 UEF	
Max. Hot Water Capacity	30° Rise: 9.2 GPM	30° Rise: 11.1 GPM
Dimensions	18.1" (w) x 26.1" (h) x 11.8" (d)	
Weight	64 pounds	
Connection Sizes	Water Inlet	3/4" NPT
	Hot Water Outlet	3/4" NPT
	Gas Inlet	3/4" NPT
	Condensate Drain	1/2" NPT
	Recirculation Return	3/4" NPT
Temperature Settings	°F Mode	100-140°F (In 5°F intervals) (9 Options)
	°C Mode	37-48°C (In 1°C intervals), 50-60°C (In 5°C intervals) (15 Options)
Freeze Protection	Indoor: -30°F / Outdoor: -4°F	
Warranty	15 year heat exchanger warranty / 5 year warranty on parts / 1 year reasonable labor	
Bluetooth® Compatible	Yes	
Venting Lengths	2" PVC (75 feet), 3" PVC (150 feet), 4" (65 feet)	
Hydrogen Compatible	Yes	
Installation	Indoor / Outdoor (with VC-6-1 vent cap)	
Recirculation Lengths	200 feet (1/2") / 500 feet (3/4")	

Additional Features

Control with our EZ Start Plus App

Our EZ Start Plus app works via Bluetooth® to bring users control of all heater functions and diagnostic tools.

Integrated Recirculation Pump

Built with an integrated pump allowing a 1/2" loop with a length of up to 200 feet (or 3/4" up to 500 feet), the longest in the industry.

1/2" Gas Line Compatible

Compatible with most installations, the 3/4" fitting is found underneath the unit for a more convenient install.

Supports 2 Crossover Valves

The NRCR Pro supports use of 2 crossover valves (item #cCS-V) for homes without a return line.

Compact Design Simplifies Installation Process

The NRCR Pro installation process is now a breeze for contractors thanks to a reduction in overall weight and a more compact design. In addition, its new longer vent capability allows for greater installation options.



NRCR PRO Featured Modes and Accessories

Equipped with a variety of customizable modes, the Noritz NRCR helps you simplify and personalize your home's hot water usage.

Featured Mode Full Recirculation

Built with an integrated pump, the NRCR brings your home hot water faster than ever by utilizing your dedicated return line.



Featured Mode Crossover Mode

With the NRCR Pro's Crossover Mode, homes without a return line can now enjoy the benefits of recirculation. Simply utilize our crossover kit (item# CSV-BPK, sold separately) and get faster hot water without the need to install additional piping.

Item# CSV-BPK

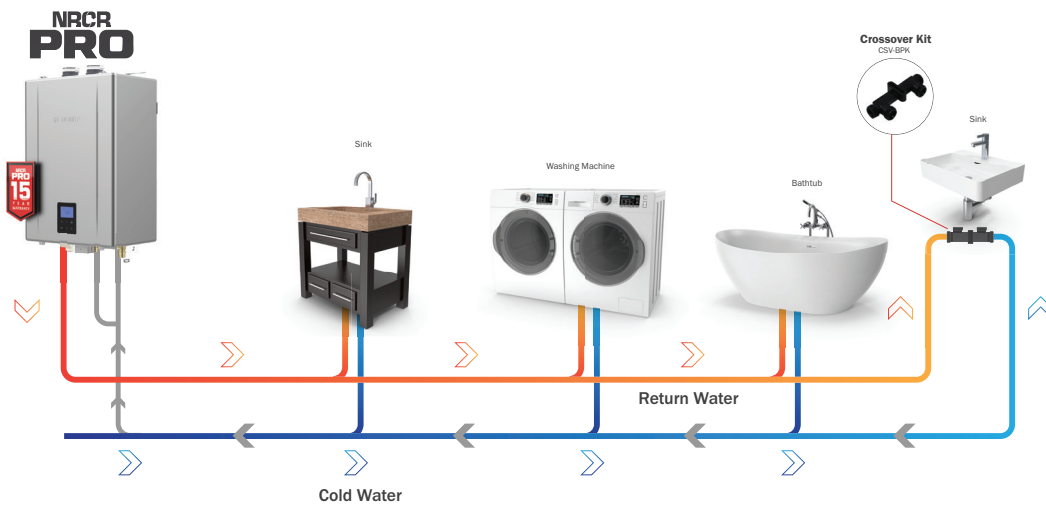

Featured Mode Two Crossover Mode

Enjoy full recirculation in larger sized homes with our Two Crossover Mode, which allows a constant flow of hot water to even the furthest fixtures.

Item# CSV-BPK & cCS-V

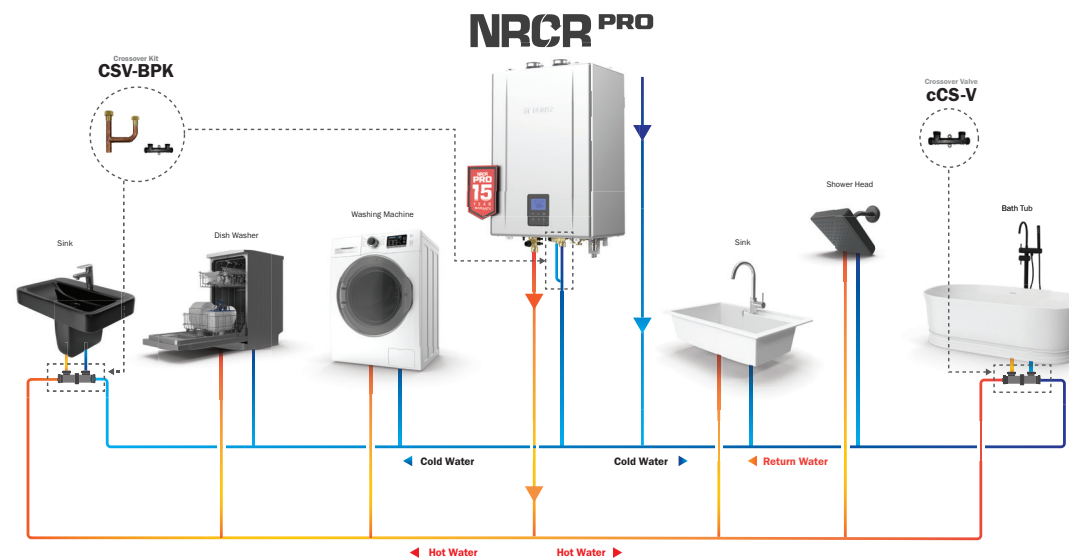

Featured Mode



The NRCR Pro's revolutionary burner control eliminates issues with high incoming water temperature in the summer by reducing effective BTU output to less than 5 KBTU. This prevents water temperature fluctuations while keeping your tankless running efficiently.

Scan your phone here to watch our SBTU Mode explainer video

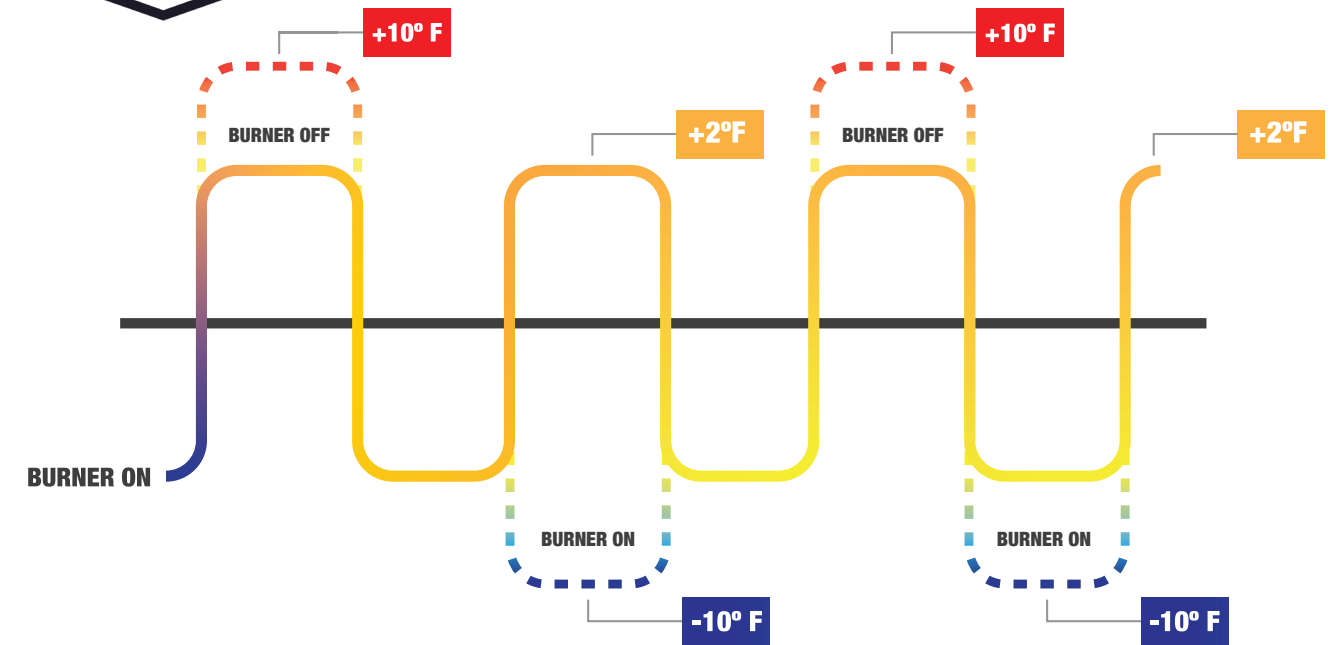

Wireless Push Buttons

Wireless On-Demand Button Kit For NRCR Pro

Our wireless on-demand button kit allows full utilization of the NRCR Pro's on-demand recirculation system. Endless hot water just got easier.



1 x Receiver 2 x Transmitters

Wireless On-Demand Button Kit

WLB

Activate the NRCR's on-demand recirculation mode with this Title 24 compliant wireless push button. Kit contents include 2 wireless transmitters, wireless receiver, and a signal connector.



1 x Transmitter

Extra WLB Transmitter

WLB-ET

One additional transmitter for WLB wireless on-demand button kit.



1 x Wireless Motion Sensor

Wireless Motion Sensor

WLB-MS

Activate your tankless water heater from anywhere in your home when you come in range of the sensor.

Additional Accessories

Item No.	Contents	Qty
CSV-BPK	Crossover Valve Kit w/ Branch Pipe	1
cCS-V	Crossover Valve	1
EZ2-CK-1	Flex Vent 2" Conversion Kit	1
EZ2-FVK-1	2" Flex Vent Kit (25 ft.)	1
EZ2FVK-2-1	2" Flex Vent Kit (35 ft.)	1
IHK-GB	On Demand Button	1
IHK-RS	On Demand Switch	1
NC-1W	Wall Hanging Residential Condensate Neutralizer Kit	1
NRK-1	No Roof Kit	1
PC-11S	NRCR Pro Pipe Cover	1
PVC-#LPT	Low Profile Termination Vent	1
SPK-EZ5	New Service Kit for Pro Models	1
SV-CK-1	2" SV Conversion Kit	1
VC-6-1	Outdoor Vent Kit	1



NRCB

COMBINATION BOILER

Most combination boilers prioritize the call for hot water while your home is being heated. This causes your home heating to go cold while things like the shower are running. The NRCB is the industry's first to be able to handle both simultaneously to provide ease and comfort.

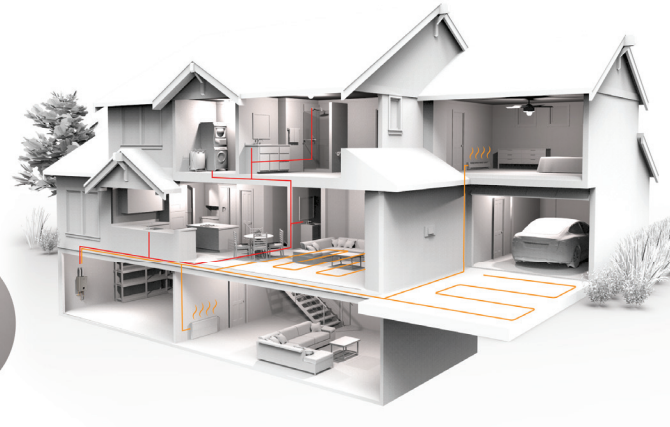

Technical Specifications

Model Number		NRCB180DV	NRCB199DV
GQ Reference Number		GHQ-C2801WX-FF US	GHQ-C3201WX-FF US
Gas Input Rate (Domestic Hot Water Mode)	Max	180,000 BTUh	199,900 BTUh
	Min	18,000 BTUh	18,000 BTUh
Gas Input (Heating Mode)	Max	100,000 BTUh	120,000 BTUh
	Min	18,000 BTUh	18,000 BTUh
Hot Water Capacity Flow Rate	35° F Rise	9.8 GPM	11.1 GPM
	45° F Rise	7.5 GPM	8.4 GPM
	80° F Rise	4.3 GPM	4.7 GPM
Installation		Indoor / Outdoor with VCK-NRCB (sold separately)	
Flue System		Sealed Combustion Direct Vent, Single Vent	
Gas Pressure	NG	3.5" WC-10.5" WC	
	LP	8.0" WC-14.0" WC	
Heat Exchanger	Primary	SS316L (Austenite)	
	Secondary	SS316L (Austenite)	
	Plate Type Heat Exchanger	SCR (Austenite)* *Stress Corrosion Resistant	
DHW Heating Priority		Simultaneous Heating and Domestic Capable	
AFUE		95%	

Features

➔ All Stainless Steel Heat Exchangers (3 Total)

Made with high quality stainless steel, these main components are built to last and bring you years of heating and hot water.

➔ Ultra Low Emissions By Premix Burner

The NRCB's Premix Burner help eliminate harmful emissions into the environment.

➔ High Delivering Capacity Of DHW

High delivery capacity ensures your home is never without hot water again. (Max 199k / 180k BTUh)

➔ Simultaneous Operating of DHW And Heating¹

The NRCB is the industry's first tankless combi boiler to offer simultaneous DHW and home heating.

➔ Stability And Quick Temperature Control Of DHW And Heating

Prevent temperature spikes with our built-in stability and quick temp control.

¹Dependent on heating and DHW temperatures



Model Lineup Information

Model Number	First Hour Rating	UEF	Storage Volume
NHP50	58	3.46	50 gal.
NHP65	70	3.34	65 gal.
NHP80	86	3.48	80 gal.
NHP120*	120	3.38	120 gal.

*NHP120 available by special order

ECOTOUGH HEAT PUMP

High Efficiency Electric

Unmatched Efficiency and Hot Water Delivery for Residential Applications

Item# NHP50/65/80/120*

Combining the latest heat pump technology with a cement lined tank for superior corrosion resistance, the Noritz EcoTough Heat Pump operates by taking air in the surrounding area and converting it to hot water which is then stored in the tank. The process utilizes less electricity than traditional water heaters, making it considerably more efficient as well. In addition, the integrated controller also provides a variety of modes for customized homeowner needs.

Features

➔ Built to Perform

The Noritz EcoTough Heat Pump features a cement lined tank for superior corrosion resistance, longer tank life, as well as reduced future maintenance.

➔ More Power - Same Footprint

Offering the same footprint of a traditional tank heater, the EcoTough Heat Pump provides greater output and efficiency without taking up more space in your home.

➔ Performance for Years to Come

Includes our industry-leading 10 year Noritz warranty, providing homeowners with years of improved hot water delivery.

➔ Ease of Use and Access

Our Noritz Heat Pump has been designed for easier installation and service accessibility by maintenance professionals.

➔ No Anode Rod Required

Unlike other heat pumps on the market, the EcoTough Heat Pump does not require an anode rod to operate.

➔ Customizable Operation Modes

Includes 5 modes to customize your heat pump and its daily operation:

- Hybrid (standard)
- Electric
- Heat Pump
- Super (High Demand)
- Vacation

Scan to view the complete technical specs for the Noritz EcoTough Heat Pump





UPGRADED FOR 2025
WITH THE NEW
**NCC199CDV
PRO**

HH

HYBRID HOT SERIES

BY NORITZ®

The First Tankless And Tank Combo From Noritz. Now With The NCC199CDV Pro.

Endless Hot Water. Quicker Recovery.

The Hybrid Hot Series by Noritz brings together the storage of a standard tank with the power and efficiency of a tankless to take on any commercial hot water demand.

Combined to meet the hot water requirements of businesses, the Hybrid Hot Series by Noritz utilizes the latest in tankless and tank storage technologies to create a powerful and reliable solution for business owners. The Hybrid Hot also offers common venting for multiple units to ensure endless hot water is always available.

Performance

Approved Gas Types	Natural Gas or Propane	
NCC199CDV Pro (GQ-C3261Z-FF US) Efficiency		0.98 UEF (For CDV Pro tankless)
	Ratings not certified by AHRI	96% Thermal Efficiency (For system)
First Hour Rating**	317 GPH	

**First hour rating is a calculation based on 100°F temperature rise, with recovery capacity plus 70% usable tank volume



Scan to watch our
**Hybrid Hot
3D Explainer Video**

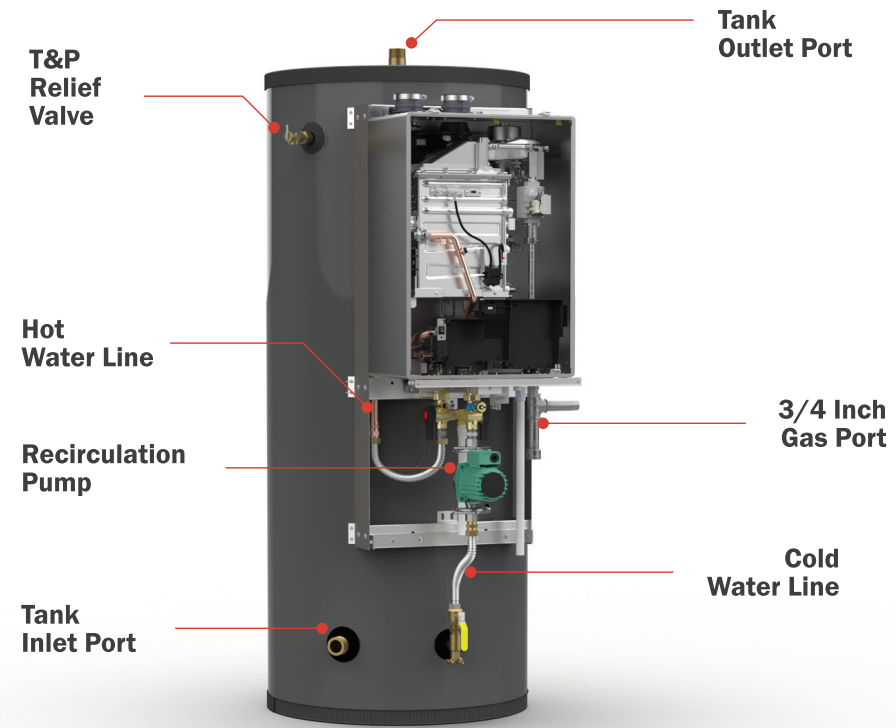

Technical Specs

Model Number		NHH199100-1
Installation Location		Indoor
Appliance Type		NCC199CDV Pro (GQ-C3261Z-FF US) Tankless Water Heater paired with Insulated Storage Tank, Pump, and Controller
Weight		536 lbs (Product Weight) 642 lbs (Shipping Weight)
Working Pressure	Water	15 - 150 psi
	Gas	NG: 3.5 - 10.5" LP: 8.0 - 13.0"
Connection Size	Cold Water	NPT 1 1/2"
	Hot Water	NPT 1 1/2"
	Return (Recirc)	NPT 3/4"
	Gas	NPT 3/4"
Vent	Type	DV / SV
	Size	2" / 3"
	Max Length	2": 75' / 3": 150'
	Common Vent	Yes (Up to 12 Units)
Dimensions		H: 67 3/4" W: 28" D: 41.2"
Power Supply		120 VAC (60Hz)
Tank Capacity		119 Gallons (Cement Lined)
Min. / Max. BTUh		12,800 - 199,900 BTUh
Water Temperature Setting		100 - 185°F (37 - 85° C)

Recovery Capacity

Product Number	Approx. Tank Capacity	Max Input (Btu/hr)	GPH (LPH) vs Temperature Rise											
			30°F	40°F	50°F	60°F	70°F	80°F	90°F	100°F	110°F	120°F	130°F	140°F
NHH199100-1	119 Gal	199,900	780	585	468	390	334	292	260	234	213	195	180	167

Features

→ The Best of Tank and Tankless

With an endless supply of hot water, lower pressure drop, and no limitation of hot water flow rate, the Hybrid Hot Series by Noritz® combines features of both technologies to provide the most reliable hot water delivery system to date for commercial applications.

→ Faster Hot Water Recovery

The Hybrid Hot offers the best BTU possible at the quickest rate, providing businesses with energy savings and more. Thanks to its larger pump, hot water recovery speed with the Hybrid Hot is faster than other tank and tankless combinations.

→ Cement Lining

With no anode rod and a greater warranty than other tanks on the market, our tank also features cement lining for superior corrosion resistance.

→ Continuous Hot Water Delivery

If your tank suddenly runs out of hot water, no need to worry. The Hybrid Hot Series by Noritz® can continue to provide hot water using the paired NCC199CDV Pro tankless even after your stored supply is depleted.*

*Hot water capabilities are limited

→ 10 Year Tank + Tankless Warranty

The Hybrid Hot Series by Noritz offers an industry leading 10 year warranty for both the tank and tankless, bringing peace of mind to business owners.

→ Upgraded with the NCC199CDV Pro

The included Noritz NCC199CDV Pro commercial tankless brings even more features and benefits to our most popular commercial tankless. This includes improved efficiency, built-in display, Bluetooth® connectivity, and more.

CMK / CRK

QUICK COMMERCIAL MANIFOLD & RACK KITS

Engineered for a streamlined installation experience, our CMK (Commercial Manifold Kit) and CRK (Commercial Rack Kit) bundle all the components needed to build a custom floor or wall mounted commercial system.*

*NCC199CDV Pro tankless units sold separately



CMK-SS Wall Hanging Bundle Kits

Includes manifold kit, wall mounting frame, and template for installation - everything needed to minimize downtime and get businesses up and running with faster hot water performance.

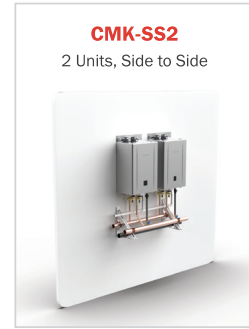

CMK-SS2
2 Units, Side to Side

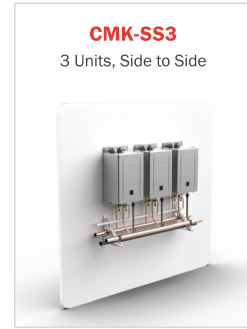

CMK-SS3
3 Units, Side to Side

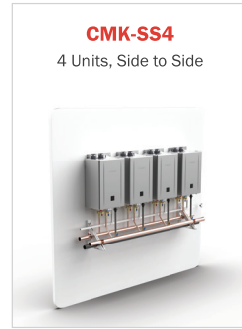

CMK-SS4
4 Units, Side to Side



CMK-BB Floor Standing Bundle Kits

Includes our manifold kit for 2 or 4 tankless units. Paired with CRK-BASE kit, the CMK-BB provides powerful performance with a faster setup.

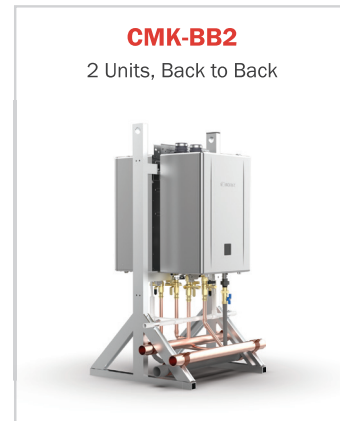

CMK-BB2
2 Units, Back to Back

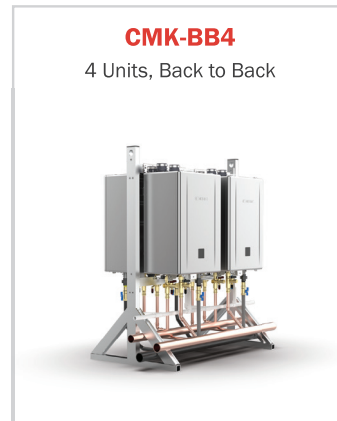

CMK-BB4
4 Units, Back to Back

Both Systems Fully Configurable Up to 24 Units*

Our CMK/CRK systems can expand up to 24 total units to tackle any business's hot water demand.

	Min. Common Gas Header	Min. Common Water Header	Min. Common Condensate Header
Up to 8 Units	2 in.	2 in.	0.75 in.
>8 and <=16	2.5 in.	2.5 in.	1 in.
>16 and <=24	3 in.	3 in.	1.25 in.

Up to 24 individual water heaters can be easily connected using multiples of CRK-BASE and CRK-ADDON kits. In order to ensure proper operation, additional accessories will be needed: System controller (SCU-401-6M, SCU-401-12M or SCU-401-24M) and remote cords (RC-CORD10 or RC-CORD26) which are sold separately, are required to ensure system balancing and load management. Manifold sizing is designed for a maximum of eight (8) water heaters. In order to connect units in greater number than eight, a common header of a larger diameter may be necessary. Refer to local plumbing and/or building code for minimum piping requirements.

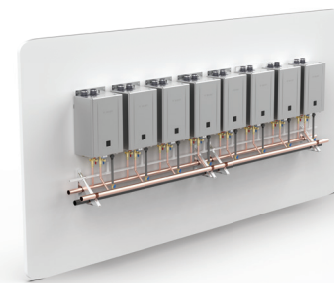

8 Units, Side to Side Wall Hanging System

Required Components:
2 x CMK-SS4
8 x NCC199CDV Pro Units
(Sold Separately)

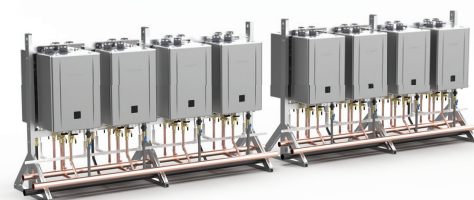

16 Units, Back to Back Floor Standing System

Required Components:
4 x CMK-BB4
2 x CRK-BASE
2 x CRK-ADDON
16 x NCC199CDV Pro Units
(Sold Separately)

Floor Standing Option

CMK-BB Floor standing, back to back

Step 1

Select number of NCC199CDV Pro tankless units needed for your system

NCC199CDV
PRO



Step 2

Choose your floor standing configuration



CMK-BB2

CMK-BB2
Floor Standing, 2 Unit
Commercial System

Max BTU/h
> 399,800 BTU/h



CMK-BB4

CMK-BB4
Floor Standing, 4 Unit
Commercial System

Max BTU/h
> 799,600 BTU/h

Step 3

Select the CRK-BASE



CRK-BASE
Expandable from
2 To 4 units

Step 4

Select optional extension for systems over 4 units



CRK-ADDON

Wall Hanging Option

CMK-SS Wall mount, side by side

Step 1

Select number of NCC199CDV Pro tankless units needed for your system



Step 2

Choose your wall hanging configuration



CMK-SS2
Wall Mounted, 2 Unit
Commercial System

Max BTU/h
> 399,800 BTU/h



CMK-SS3
Wall Mounted, 3 Unit
Commercial System

Max BTU/h
> 599,700 BTU/h



CMK-SS4
Wall Mounted, 4 Unit
Commercial System

MAX BTU/h
> 799,600 BTU/h



Scan to Watch
Our CMK
Explainer Video



Commercial Rack System (CR)

The Noritz CR Commercial Rack System (formerly CWHS) is designed for maximum performance and ease of installation. Our CR is a pre-fabricated racking system for use in flat rooftop or mechanical room applications for commercial multi-systems. A low profile design and a variety of installation options make this rack system ideal for business owners looking to replace outdated storage tanks.

Features

- Low Profile Design**

Redesigned with lower center of gravity for increased stability and easier transportation.
- Reduced Install Time**

Pre-piped condensate manifold and condensate line along with pre-wiring required for multi-systems reduces installation time.
- Wall Mount Option**

The redesigned wall mounted option allows for more space savings without sacrificing performance.
- Easy Scalability**

Standardized water and gas lines allow easy connection of multiple rack systems in-line.
- Simplified Venting**

Built-in non-return valve allows for common venting up to 6 units on a single manifold without the need for external accessories.

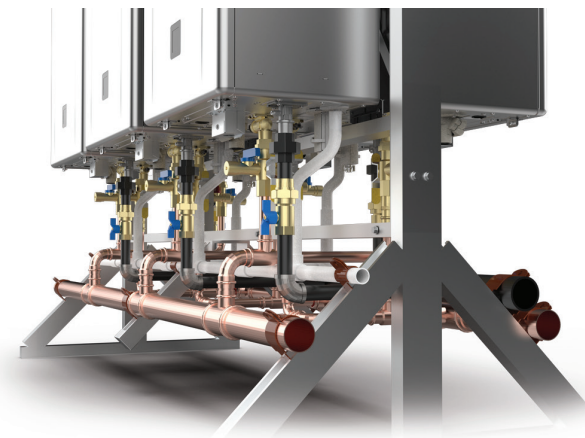

Also Available

CA Commercial System Update

The updated Noritz CR Commercial Rack System brings new features designed to create a hassle free and easy installation. The CR system update comes with a redesigned gas header with built-in gas sediment traps and an additional shutoff valve, simplifying both installation and service.

Benefits of a Noritz CR System



Efficiency

Each CR system comes standard with the ultra-efficient NCC199CDV Pro model unit, rated at 0.98 UEF. Fully modulating, with turn-down ratios of up to 96:1¹, the CR system provides exceptional energy savings potential over a storage tank set up. With all of these benefits plus the Noritz trademark quality, the Noritz CR system provides a true business-friendly replacement for any existing system.



Redundancy

Multiple Noritz water heaters provide built-in redundancy, ensuring continuous hot water even if a unit goes down. Included isolation valves make maintenance easy without interrupting service to the rest of the building, and the included system controller monitors each unit for even wear and proper operation.



Flexibility

The CR offers unmatched versatility compared to boiler or storage systems. At just 30" deep, it fits through any standard 32" doorway and can be installed indoors or outdoors, floor- or wall-mounted — significantly reducing your building footprint.

Indoor installations support PVC, CPVC, or PP venting in horizontal or vertical configurations, with the option to use either room air or direct vent combustion air.

¹With one 6 unit system CR rack. Multiple racks can be combined together to get turn down ratios of up to 384:1 with 24 units and the SCU-401-24M system controller.

Dimensions

Item Number	Rack Type	UPC	Included Main Components		Cold / Hot Water & Gas Manifold				Rack Dimensions			Total Weight (lbs)
			GQ-C3261WZ-FF US NG	SC-401-6M	Cold	Hot	Condensate Drain Manifold	Gas Manifolds	L	D	H	
CR61-WH-2	2 Unit Wall Hanging, NG & LP Convertible	817000014322	2	1	2"	2"	3/4"	2"	54 1/4"	17"	44"	243
CR61-WH-2-CA	2 Unit Wall Hanging, NG & LP Convertible; California (CPC) Compliant	817000016050	2	1	2"	2"	3/4"	2"	54 1/4"	17"	44"	243
CR61-WH-3	3 Unit Wall Hanging, NG & LP Convertible	817000014353	3	1	2"	2"	3/4"	2"	78"	17"	44"	362
CR61-WH-3-CA	3 Unit Wall Hanging, NG & LP Convertible; California (CPC) Compliant	817000016142	3	1	2"	2"	3/4"	2"	78"	17"	44"	362
CR61-FS-3	3 Unit Free Standing, NG & LP Convertible	817000015657	3	1	2"	2"	3/4"	2"	52 1/4"	30"	56 3/4"	362
CR61-FS-3-CA	3 Unit Free Standing, NG & LP Convertible; California (CPC) Compliant	817000016289	3	1	2"	2"	3/4"	2"	52 1/4"	30"	56 3/4"	362
CR61-FS-4	4 Unit Free Standing, NG & LP Convertible	817000015831	4	1	2"	2"	3/4"	2"	54 1/4"	30"	56 3/4"	412
CR61-FS-4-CA	4 Unit Free Standing, NG & LP Convertible; California (CPC) Compliant	817000016296	4	1	2"	2"	3/4"	2"	54 1/4"	30"	56 3/4"	412
CR61-FS-5	5 Unit Free Standing, NG & LP Convertible	817000015886	5	1	2"	2"	3/4"	2"	78"	30"	56 3/4"	520
CR61-FS-5-CA	5 Unit Free Standing, NG & LP Convertible; California (CPC) Compliant	817000016371	5	1	2"	2"	3/4"	2"	78"	30"	56 3/4"	520
CR61-FS-6	6 Unit Free Standing, NG & LP Convertible	817000015978	6	1	2"	2"	3/4"	2"	78"	30"	56 3/4"	593
CR61-FS-6-CA	6 Unit Free Standing, NG & LP Convertible; California (CPC) Compliant	817000016678	6	1	2"	2"	3/4"	2"	78"	30"	56 3/4"	593

Hot Water Supply Capacity

Item Number	Heater Quantity	Heater Configuration	Min BTU/hr Input	Max BTU Input	Hot Water Capacity (GPM)						
					50°	60°	70°	80°	90°	100°	110°
CR61-WH-2	2	Wall Hanging In-Series	12,800	399,800	15.7	13.1	11.2	9.8	8.7	7.8	7.1
CR61-WH-3	3	Wall Hanging In-Series	12,800	599,700	23.5	19.6	16.8	14.7	13.1	11.8	10.7
CR61-FS-3	3	Free Standing	12,800	599,700	23.5	19.6	16.8	14.7	13.1	11.8	10.7
CR61-FS-4	4	Free Standing 2x2 Back to Back	12,800	799,600	31.3	26.1	22.4	19.6	17.4	15.7	14.2
CR61-FS-5	5	Free Standing 3x2 Back to Back	12,800	999,500	39.2	32.7	28.0	24.5	21.8	19.6	17.8
CR61-FS-6	6	Free Standing 3x3 Back to Back	12,800	1,199,400	47.0	39.2	33.6	29.4	26.1	23.5	21.4

Additional Installation Options and Accessories



Wall Hanging Rack

The wall hanging rack allows installers to accommodate for existing conduit and piping without interference, reducing additional installation time. A floor stand also comes included which allows for easy positioning while fixing to a wall.



CR60 Wheel Kit

The Noritz wheel kit is designed to simplify logistics of moving Noritz Commercial Racks from the crate to the mechanical room. Designed to last, the wheel kits are compatible to move all Noritz Commercial Rack configurations for years to come.

Features

- Faster Mobility**

Relocate your CR system with ease using our wheel kit's rubber casters for a fast and smooth transition.
- Designed for the CR**

The Noritz wheel kit is designed to work smoothly with all configurations of Noritz Commercial Rack systems.
- Move Your System With Ease**

Placed at the ends of your CR floor standing system, the Noritz wheel kit provides installers an easier way to pick up and move without the need for heavy lifting.

The Total Tankless Solution

TTS SYNERGY SERIES

Offering high performance tankless rack systems as well as options to pair with a storage tank, the TTS Synergy Series offers industry leading performance in a wide range of configurations. Commercial Tankless engineering meets high performance with the TTS Synergy Series.

➤ **One Point Of Connection**

All connections are shared with the TTS Synergy Series via our one point of connection feature, providing a more streamlined installation that saves time while cutting costs in labor and additional parts.

➤ **Powered by the NCC199CDV Pro**

Our TTS Synergy Series utilizes the NCC199CDV Pro, which features the best warranty in the tankless industry - 10 years on the unit's heat exchanger.

➤ **Smaller Footprint**

The TTS Synergy Series provides greater space savings by using a compact design - giving it the ability to combine multiple heaters into the smallest footprint possible.

➤ **Storage and Wall Hanging Options Available**

In addition to our floor standing model, we also offer wall hanging configurations as well as storage and no storage tank options.

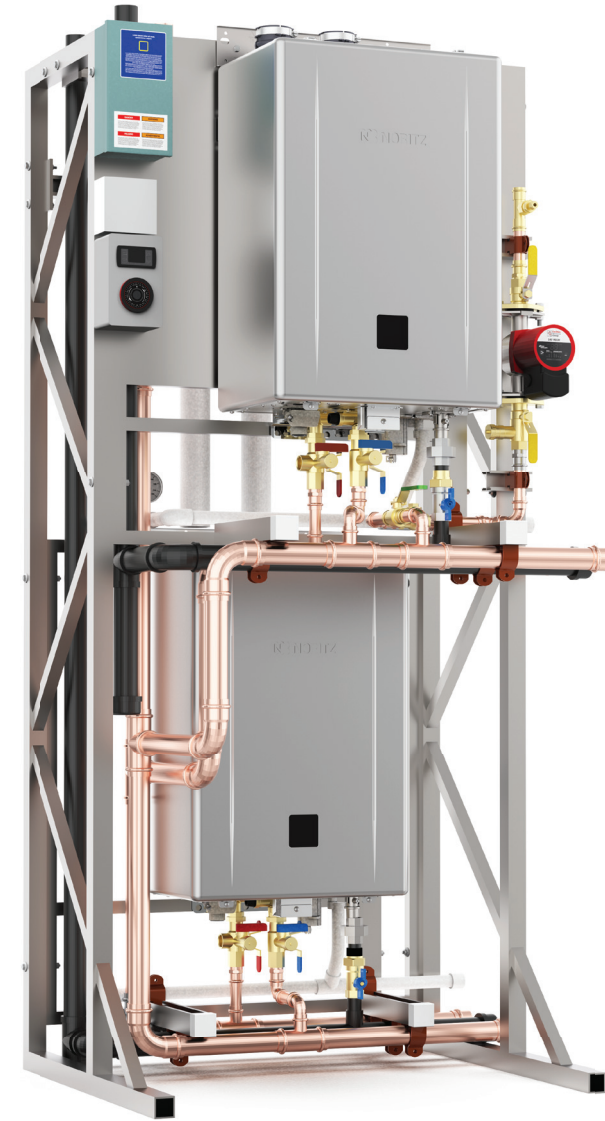

TTS-SWH Series

Item Number	Description	UPC
TTS-SWH2	Total Tankless Solution (Wall Hung) / Standard Model, 2 Unit NG & LP Convertible	817000016784
TTS-SWH3	Total Tankless Solution (Wall Hung) / Standard Model, 3 Unit NG & LP Convertible	817000016807
TTS-SWH4	Total Tankless Solution (Wall Hung) / Standard Model, 4 Unit NG & LP Convertible	817000016944

S Series

Item Number	Description	UPC
TTS-S2MINI	Total Tankless Solution (Compact Version) / Standard Model, 2 Unit NG & LP Convertible	817000016982
TTS-S3	Total Tankless Solution / Standard Model, 3 Unit NG & LP Convertible	817000017255
TTS-S4MINI	Total Tankless Solution (Compact Version) / Standard Model, 4 Unit NG & LP Convertible	817000017194
TTS-S5	Total Tankless Solution / Standard Model, 5 Unit NG & LP Convertible	817000017705
TTS-S6	Total Tankless Solution / Standard Model, 6 Unit NG & LP Convertible	817000017835

TWST Series

Item Number	Description	UPC
TTS-TWST2	Total Tankless Solution / Tankless with Storage Tank Model, 2 Unit NG & LP Convertible	817000014735
TTS-TWST3	Total Tankless Solution / Tankless with Storage Tank Model, 3 Unit NG & LP Convertible	817000017927
TTS-TWST4	Total Tankless Solution / Tankless with Storage Tank Model, 4 Unit NG & LP Convertible	817000017965
TTS-TWST5	Total Tankless Solution / Tankless with Storage Tank Model, 5 Unit NG & LP Convertible	817000018368
TTS-TWST6	Total Tankless Solution / Tankless with Storage Tank Model, 6 Unit NG & LP Convertible	817000018375
TTS-TWST2NST	Total Tankless Solution / Tankless with Storage Tank Model (Field Supplied Storage Tank), 2 Unit NG & LP Convertible	817000019372
TTS-TWST3NST	Total Tankless Solution / Tankless with Storage Tank Model (Field Supplied Storage Tank), 3 Unit NG & LP Convertible	817000019693
TTS-TWST4NST	Total Tankless Solution / Tankless with Storage Tank Model (Field Supplied Storage Tank), 4 Unit NG & LP Convertible	817000019730
TTS-TWST5NST	Total Tankless Solution / Tankless with Storage Tank Model (Field Supplied Storage Tank), 5 Unit NG & LP Convertible	817000019907
TTS-TWST6NST	Total Tankless Solution / Tankless with Storage Tank Model (Field Supplied Storage Tank), 6 Unit NG & LP Convertible	817000014742



Also Available
FIOP

Factory Installed Options

Our FIOP is our custom offerings that are tailored to the needs and demands of a business. If a demand is greater than one of our standard offerings, this is the solution for you.

TTS-SWH2



Model: TTS-SWH2 Max BTU/hr: 399,800

TTS-SWH3



Model: TTS-SWH3 Max BTU/hr: 599,700

TTS-SWH4



Model: TTS-SWH4 Max BTU/hr: 799,600

TTS-SWH Series

TTS-SWH2, TTS-SWH3, TTS-SWH4

The new TTS-SWH Series provides businesses with an all-new way to meet their water heating needs. This wall hung configuration brings even more space savings without sacrificing hot water delivery & continues to provide the redundancy found in the TTS Family.

Scan to view spec sheets and more for TTS-SWH



Features

- OPC (One Point of Connection) for water, recirculation return line, power, gas, venting & condensation drain
- Manifold systems
 - Hot water outlet, cold water inlet, gas, & condensate drain
- Building recirculation
- Reduction in labor hours
- Includes wall bracket
- Worry-free installation
- Designed to fit through 3'-0" x 7'-0" door
- Pre-engineered system
- Pre-configured control wiring
- Pre-installed system controllers
- Warranty
 - 10 years heat exchanger per tankless unit
 - 5 years water heater parts & components
 - 3 year circulation pump
- 1 year labor
- Additional included accessories:
 - Condensate neutralizer (Qty 1)
 - Expansion tank (Non-ASME)
 - 4.5 gallon (TTS-S2MINI/3/4MINI Models)

S Series

TTS-S2MINI, TTS-S3, TTS-S4MINI, TTS-S5, TTS-S6

The S Series utilizes a floor standing configuration and boasts all features found on our TTS Systems. Features a BTU range of 399,800 – 1,199,400 which is powerful enough for most commercial needs.

Features

- One Point of Connection
- Aluminum Frame
- 2 to 6 - Noritz NCC199CDV Pro (GQ61) Tankless Water Heaters with System Controller
- 1 1/2" Water & Gas Manifolds
- 3/4" Condensate Drain Manifold
- Expansion Tank Included
- Breaker Box w/ Included Circuit
- Breakers
- Pump Controller with Timer
- Surge Protector
- Building Recirculation Pump
- Shutoff Valves
- Well Immersed Thermistors for Easy Monitoring of Building Hot Water Performance



TTS-S2MINI
Up to 399,800 BTU/hr

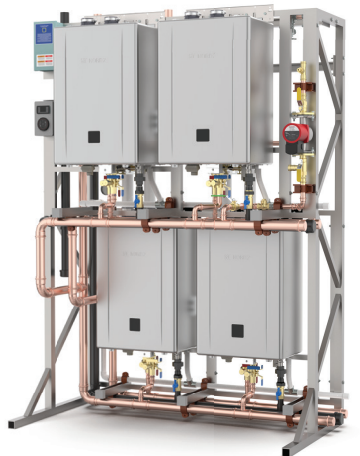

TTS-S4MINI
Up to 799,600 BTU/hr

Scan to view spec sheets and more for S Series



Tankless with Storage

TWST Series

TWST2, TWST3, TWST4, TWST5, TWST6

The TWST Series boasts all the features found on our TTS Systems while also utilizing a storage tank. This system can range from 399,800 to 1,199,400 BTU meaning it has enough power for most commercial scenarios.

Features

- One Point of Connection
- Aluminum Frame
- 2 to 6 - Noritz NCC199CDV Pro (GQ61) Tankless Water Heaters with System Controller
- 120 Gallon Storage Tank Included
- 1 1/2" Water & Gas Manifolds
- 3/4" Condensate Drain Manifold
- Expansion Tank Included
- Breaker Box w/ Included Circuit Breakers
- Pump Controller with Timer
- Surge Protector
- Building Recirculation Pump
- Storage Tank Recovery Circulator
- Shutoff Valves
- Well Immersed Thermistors for Easy Monitoring of Building Hot Water Performance
- 2" Hot Water Supply to Storage Tank
- Y - Strainer
- 2" Cold Make Up Water
- 2" Supply through Pump to Tankless
- 2" Pump Bypass
- Integrated 2" Check Valves







Model Shown:
TTS-TWST6

Scan to view spec sheets and more for TWST Series



High Efficiency (Condensing)

	EZ SERIES PRO		NRCR PRO		EZ SERIES PRO	
EZ & NRCR						
Model	EZ111DV	NRCR111DV	EZ98DV	NRCR92DV	EZ71DV	
GQ Reference Number	GQ-C3261WX-FF-1 US NG	GQ-C3261WXQ-FF-1 US NG	GQ-C2861WX-FF-1 US NG	GQ-C2661WXQ-FF-1 US NG	GQ-C2661WX-FF-1 US NG	
Vent Type	Versatile Venting		Versatile Venting		Versatile Venting	
SV Conversion	Yes	Yes	Yes	Yes	Yes	
Dimensions (Inches)	26.1" x 18.1" x 11.8"		26.1" x 18.1" x 11.8"		26.1" x 18.1" x 11.8"	
Weight (lbs)	62 lbs.	64 lbs.	62 lbs.	64 lbs.	62 lbs.	
Min./Max. BTUh	12,800 - 199,900		12,800 - 180,000		12,800 - 160,000	
UEF	0.98		0.98		0.98	
Max. Hot Water Capacity	30°F Rise: 11.1 GPM		30°F Rise: 9.8 GPM		30°F Rise: 7.1 GPM	
Water Inlet	3/4"					
Hot Water Outlet	3/4"					
Gas Inlet (1/2 in. capable)	3/4" (1/2 in. up to 40 ft.)		3/4" (1/2 in. up to 50 ft.)	3/4" (1/2 in. up to 60 ft.)	3/4" (1/2 in. up to 60 ft.)	
Temp. Settings	100-140°F (In 5° intervals) (9 Options)	100-140°F (In 5° intervals) (9 Options)	100-140°F (In 5° intervals) (9 Options)	100-140°F (In 5° intervals) (9 Options)	100-140°F (In 5° intervals) (9 Options)	
Warranty	25 YEAR HEAT EXCHANGER, 5 year warranty on parts & 1 year reasonable labor	15 YEAR HEAT EXCHANGER, 5 year warranty on parts & 1 year reasonable labor	25 YEAR HEAT EXCHANGER, 5 year warranty on parts & 1 year reasonable labor	15 YEAR HEAT EXCHANGER, 5 year warranty on parts & 1 year reasonable labor	25 YEAR HEAT EXCHANGER, 5 year warranty on parts & 1 year reasonable labor	
Hydrogen Compatible	Yes					
Ultra Low NOx	Yes					
Quick Connect	Yes					
Remote Included	No					
Min/Max Flow rate	0.4 GPM / 11.1 GPM	0.5 GPM / 11.1 GPM	0.4 GPM / 9.8 GPM	0.5 GPM / 9.2 GPM	0.4 GPM / 7.1 GPM	
Wifi Compatible	Yes					
Bluetooth® Compatible	Yes					
High Altitude Approved	Up to 10,200 ft.					
Mobile Home Approved	Yes (OD or DV Install Only)					
PVC	2" or 3" or 4"					
Energy Star	Yes					
Pump Kit Compatible	Yes	No	Yes	No	Yes	
Venting	2"/3"/4" PVC Vent 2" Flex Pipe					

Vent Type

DV - Direct Vent
SV - Single Vent
DVC - Direct Vent Concentric
OD - Outdoor

Versatile Venting









See page 6

Approvals

Residential



High Efficiency (Condensing)

	NRC							
NRC								
Model	NRC111DV	NRC111OD	NRC98DV	NRC98OD	NRC711DV	NRC711OD	NRC661ADV	NRC661AOD
GQ Reference Number	GQ-C3257WX-FF US	GQ-C3257WX US	GQ-C2857WS-FF US	GQ-C2857WS US	N/A	N/A	N/A	N/A
Vent Type	DV	OD	DV	OD	DV	OD	DV	OD
SV Conversion	Yes	N/A	Yes	N/A	Yes	N/A	Yes	N/A
Dimensions (Inches)	24.2" x 18.3" x 9.4"	24.2" x 18.3" x 9.4"	24.2" x 18.3" x 9.4"	24.2" x 18.3" x 9.4"	23.6" x 13.8" x 6.7"	20.5" x 13.8" x 6.7"	23.6" x 13.8" x 6.7"	23.6" x 13.8" x 6.7"
Weight (lbs)	68 lbs.	66 lbs.	58 lbs.	57 lbs.	41 lbs.	40 lbs.	39 lbs.	36 lbs.
Min./Max. BTUh	16,000-199,900		16,000 - 180,000		15,000 - 157,000		15,000-120,000	
UEF	0.91	0.91	0.91	0.92	0.89	0.89	0.89	0.89
Max. Hot Water Capacity	30°F Rise: 11.1 GPM		30°F Rise: 9.8 GPM		30°F Rise: 7.1 GPM		30°F Rise: 6.6 GPM	
Water Inlet	3/4"							
Hot Water Outlet	3/4"							
Gas Inlet (1/2 in. capable)	3/4" (1/2 in. up to 40 ft.)		3/4" (1/2 in. up to 50ft)		3/4" (1/2 in. up to 70ft)		1/2" (1/2 in. up to 100 ft)	1/2" (1/2 in. up to 100 ft)
Temp. Settings	100-140°F (In 5° intervals)			115-140°F (In 5° Intervals)				
Default Temp. Option	120, 125, 130, 140°F				120, 130, 135, 140°F			
Warranty	12 year warranty on heat exchanger, 5 year warranty on parts & 1 year reasonable labor (Residential Installs)							
Ultra Low NOx	Yes							
Quick Connect	Yes				No			
Remote Included	Yes				Digital Display			
Min/Max Flow rate	0.5 GPM / 11.1 GPM		0.5 GPM / 9.8 GPM		0.5 GPM / 7.1 GPM		0.5 GPM / 6.6 GPM	
Wifi Compatible	Yes							
High Altitude Approved	Up to 8,000 ft.							
Mobile Home Approved	Yes (OD or DV Install Only)							
PVC	3" or 4"	No	3" or 4"	No	3"	No	3"	No
Energy Star	Yes							
Pump Kit Compatible	Yes				No			
Venting	3" / 4" PVC Vent	N/A	3" / 4" PVC Vent	N/A	3" PVC Vent	N/A	3" PVC Vent	N/A

Mid Efficiency (Non Condensing)

NR							
	Model	NR98DVC	NR98SV	NR98OD	NR83DVC	NR83OD	NR662OD
GQ Reference Number	GQ-2857WX-FFA US LP GQ-2857WX-FFA US NG	GQ-2857WX-F US LP GQ-2857WX-F US NG	GQ-2857WX US LP GQ-2857WX US NG	GQ-2457WS-FFA US LP GQ-2457WS-FFA US NG	GQ-2457WS US LP GQ-2457WS US NG	N/A	N/A
Vent Type	DVC	SV	OD	DVC	OD	OD	OD
SV Conversion	N/A						
Dimensions (Inches)	23.6" x 13.8" x 9.4"	23.6" x 13.8" x 9.4"	23.6" x 13.8" x 9.4"	23.6" x 13.8" x 9.4"	23.6" x 13.8" x 9.4"	20.5" x 13.8" x 6.7"	20.5" x 13.8" x 6.7"
Weight (lbs)	58 lbs.	54 lbs.		49 lbs.	45 lbs.	35 lbs.	32 lbs.
Min./Max. BTU/h	16,000 - 199,900			18,000 - 180,000		15,000-140,000	15,000-120,000
UEF	0.82						
Max. Hot Water Capacity	30° F Rise: 9.8 GPM			30° F Rise: 8.3 GPM		30° F Rise: 6.6 GPM	30° F Rise: 5.0 GPM
Water Inlet	3/4"						
Hot Water Outlet	3/4"						
Gas Inlet (1/2 in. capable)	3/4" (1/2" up to 40ft)			3/4" (1/2" up to 50ft)		3/4" (1/2" up to 80ft)	1/2" (1/2" up to 100ft)
Temp. Settings	100-140° F (In 5° Intervals)			115-140° F (In 5° Intervals)			
Default Temp. Option	120, 125, 130, 140° F					120, 130, 135, 140° F	
Warranty	12 year warranty on heat exchanger, 5 year warranty on parts & 1 year reasonable labor* (Residential Installs)						
Ultra Low NOx	Yes						
Quick Connect	Yes					No	
Remote Included	Yes					Digital Display	
Min/Max Flow rate	0.5 GPM / 9.8 GPM			0.5 GPM / 8.3 GPM		0.5 GPM / 6.6 GPM	0.5 GPM / 5.0 GPM
Wifi Compatible	Yes						
High Altitude Approved	Up to 8,000 ft.						
Mobile Home Approved	Yes	No	Yes				
PVC	No						
Energy Star	No						
Bundle Kit	Yes	No		Yes	No		No
Pump Kit Compatible	Yes					No	

Commercial Models

NC NCC						
	Condensing			Non-Condensing		
Model	NCC3000D	NCC300DV	NCC199CDV	NC380SV	NC199DVC	NC199OD
GQ Reference Number	GQ-C5032WZ US	GQ-C5032WZ-FF US	GQ-C3261WZ-FF-1 US NG	N/A	GQ-2857WZ-FFA US	GQ-2857WZ US
SV Conversion	N/A	Yes	Yes	No	N/A	N/A
Vent Type	OD	DV	DV / OD	SV	DVC	OD
Dimensions (Inches)	32.7" x 18.9" x 14.2"		26.1" x 18.1" x 11.8"	29.7" x 19.1" x 11.8"	23.6" x 13.8" x 11.0"	23.6" x 13.8" x 9.4"
Weight (lbs)	108 lbs.		62 lbs.	106 lbs.	58 lbs.	54 lbs.
Min./Max. BTU/h	15,000 - 300,000**		12,800 - 199,900	22,500 - 380,000**	16,000 - 199,900	
Thermal Efficiency% / UEF	97%		0.98 UEF	NG: 80% LP: 81%	0.82 UEF	
Max. Hot Water Capacity	35° F Rise: 13.2 GPM		35° F Rise: 11.1 GPM	35° F Rise: 13.2 GPM	35° F Rise: 9.8 GPM	
Water Inlet	1"		3/4"	1"	3/4"	3/4"
Hot Water Outlet	1"		3/4"	1"	3/4"	3/4"
Gas Inlet (1/2 in. capable)	3/4"		3/4"	3/4"	3/4"	3/4"
Temp. Settings	100-150° F (In 5° F Intervals), 160, 170, 185° F		100-150° F (In 5° F Intervals), 160, 170, 185° F	100-150° F (In 5° F Intervals), 160, 170, 180° F	100-150° F (In 5° F Intervals), 160, 170, 185° F	
Default Temp. Option	120, 130, 140, 185° F		N/A	120, 130, 140, 180° F	120, 130, 140, 185° F	
Warranty	5 year warranty on heat exchanger, 5-year warranty on parts & 1-year reasonable labor*		10 YEAR WARRANTY ON HEAT EXCHANGER , 5 year warranty on parts & 1 year reasonable labor*	5 year warranty on heat exchanger, 5 year warranty on parts & 1 year reasonable labor*		
Ultra Low NOx	Yes			No	Yes	
Quick Connect	Yes					
Remote Included	Yes		Digital Control Panel	Yes		
Min/Max Flow rate	0.5 GPM / 13.2 GPM		0.4 GPM / 11.1 GPM	0.7 GPM / 13.2 GPM	0.5 GPM / 9.8 GPM	
High Altitude Approved	Up to 4,500 ft.		Up to 10,200 ft.	Up to 8,000 ft.		
Wifi Compatible	Yes					
Common Vent Capable	No		Up to 12 Units	No		
Commercial Energy Star	Yes			No		
PVC	No	Yes		No		
ASME	No***		No	Yes	No	

Approvals Commercial



*Refer to our warranty terms & conditions for more details.

**Disclaimer: For units with more output than 200,000 BTU/h, please check with your local boiler inspector to verify if ASME is required in your state.

***Only available for installation in the following states: California, Minnesota, and Wisconsin. Please check your local codes for details.

Temperature Rise

Temp Rise (F°)	Commercial						Residential										
	Condensing			Non-Condensing			Condensing						Non-Condensing				
	NCC300	NCC199CDV Pro	NC380	NC199	EZ111 Pro	NRCR111 Pro	NRC111	EZ98 Pro	NRC98	NRCR92 Pro	EZ71 Pro	NRC711	NRC66/EZTR40	NR98	NR83	NR662	NR501
30	13.2	11.1	13.2	9.8	11.1	11.1	11.1	9.8	9.8	9.2	9.0	7.1	6.6	9.8	8.3	6.6	5.0
35	13.2	11.1	13.2	9.6	11.1	11.1	10.9	9.8	9.6	9.2	8.4	7.1	6.4	9.6	8.3	6.6	5.0
40	13.2	9.8	13.2	8.4	9.8	9.7	9.3	8.6	8.4	8.0	7.7	7.1	5.5	8.4	7.6	5.8	5.0
45	12.4	8.7	13.2	7.5	8.7	8.6	8.4	7.6	7.4	7.1	6.9	6.5	4.9	7.5	6.7	5.3	4.2
50	11.6	7.8	12.2	6.7	7.8	7.8	7.4	6.9	6.7	6.4	6.2	5.8	4.4	6.7	6.1	4.6	3.9
55	10.6	7.1	11.1	6.1	7.1	7.1	6.9	6.3	6.1	5.8	5.7	5.3	4.1	6.1	5.5	4.3	3.7
60	9.7	6.5	10.1	5.6	6.5	6.5	6.2	5.7	5.6	5.3	5.2	4.9	3.7	5.6	5.0	3.8	3.3
65	9.0	6.0	9.4	5.2	6.0	6.0	5.8	5.3	5.2	4.9	4.8	4.5	3.4	5.2	4.7	3.6	3.1
70	8.3	5.6	8.7	4.8	5.6	5.5	5.3	4.9	4.8	4.6	4.4	4.2	3.2	4.8	4.3	3.3	2.8
75	7.8	5.2	8.1	4.5	5.2	5.2	5.1	4.6	4.5	4.3	4.0	3.9	3.0	4.5	4.0	3.1	2.7
80	7.3	4.9	7.6	4.2	4.9	4.8	4.6	4.4	4.2	4.0	3.9	3.7	2.8	4.2	3.8	2.9	2.5
85	6.8	4.6	7.2	4.0	4.6	4.6	4.5	4.1	3.9	3.8	3.6	3.4	2.6	4.0	3.6	2.8	2.4
90	6.5	4.4	6.8	3.7	4.4	4.3	4.1	3.8	3.7	3.6	3.4	3.2	2.5	3.7	3.4	2.6	2.2
95	6.1	4.1	6.4	3.5	4.1	4.1	4.0	3.6	3.5	3.4	3.2	3.1	2.3	3.5	3.2	2.5	2.1
100	5.8	3.9	6.1	3.4	3.9	3.9	3.7	3.4	3.4	3.2	3.1	2.9	2.2	3.4	3.0	2.3	2.0

Gas Sizing Charts

Length (including fittings)

Pipe Size	10'	20'	30'	40'	50'	60'	70'	80'	90'	100'	125'
	3m	6m	9m	12m	15m	18m	21m	24m	27m	30m	38m
3/4"	360	247	199	170	151	137	126	117	110	104	92
1"	678	466	374	320	284	257	237	220	207	195	173
1 1/4"	1,390	957	768	657	583	528	486	452	424	400	355
1 1/2"	2,090	1,430	1,150	985	873	791	728	677	635	600	532
2"	4,020	2,760	2,220	1,900	1,680	1,520	1,400	1,300	1,220	1,160	1,020
2 1/2"	6,400	4,400	3,530	3,020	2,680	2,430	2,230	2,080	1,950	1,840	1,630
3"	11,300	7,780	6,250	5,350	4,740	4,290	3,950	3,670	3,450	3,260	2,890
4"	23,100	15,900	12,700	10,900	9,660	8,760	8,050	7,490	7,030	6,640	5,890

Table 1
For less than 8" WC initial supply pressure

















Maximum natural gas delivery capacity (0.5" Pressure Drop) [Schedule 40 Metallic Pipe]

Values in Table are in Cubic Feet of Gas per Hour (0.60 Specific Gravity, 0.5" Pressure Drop, inlet pressure less than 2 psi). Contact your gas supplier for BTU/Cubic Foot ratings. For simplification of your calculations, 1 Cubic Foot of Gas is approximately equivalent to 1000 BTU.

Temperature Rise - Combi Boilers

Temp Rise (F°)	Boilers	
	NRCB199	NRCB180
30	11.1	9.8
35	10.8	9.8
40	9.5	8.5
45	8.4	7.5
50	7.6	6.8
55	6.9	6.2
60	6.3	5.7
65	5.8	5.3
70	5.4	4.9
75	5.0	4.6
80	4.7	4.3
85	4.4	4.0
90	4.2	3.8
95	4.0	3.6
100	3.8	3.4

Sizing Chart

Model Number	Summer Water Supply (70 °f)		Winter Water Supply (45 °f)	
	NC380		5.3 Showers At 13.2 GPM	
NCC300		5.3 Showers At 13.2 Gpm		3.5 Showers At 8.75 GPM
NRCR111, NRC111, NCC199, EZ111, NRCB199		4.1 Showers At 10.6 GPM		2.5 Showers At 6.2 GPM
NRC98, NR98, NC199, EZ98, NRCB180		3.7 Showers At 9.2 GPM		2.2 Showers At 5.6 GPM
EZ71, NR83, NRCR92		3.3 Showers At 8.1 GPM		2.0 Showers At 5.0 GPM
NRC711		3.1 Showers At 7.8 GPM		2.0 Showers At 4.8 GPM
NRC661, NR662 EZTR40		2.6 Showers At 6.6 GPM		1.5 Showers At 3.8 GPM
NR501		2.0 Showers At 5.0 GPM		1 Shower At 3.3 GPM

Length (including fittings)

Pipe Size	10'	20'	30'	40'	50'	60'	70'	80'	90'	100'	125'
	3m	6m	9m	12m	15m	18m	21m	24m	27m	30m	38m
1/2"	454	312	250	214	190	172	158	147	138	131	116
3/4"	949	652	524	448	397	360	331	308	289	273	242
1"	1,787	1,228	986	844	748	678	624	580	544	514	456
1 1/4"	3,669	2,552	2,025	1,733	1,536	1,392	1,280	1,191	1,118	1,056	936
1 1/2"	5,497	3,778	3,034	2,597	2,302	2,085	1,919	1,785	1,675	1,582	1,402
2"	10,588	7,277	5,844	5,001	4,433	4,016	3,695	3,437	3,225	3,046	2,700
2 1/2"	16,875	11,598	9,314	7,971	7,065	6,401	5,889	5,479	5,140	4,856	4,303
3"	29,832	20,503	16,465	14,092	12,489	11,316	10,411	9,865	9,087	8,584	7,608
4"	43,678	30,020	24,107	20,632	18,286	16,569	15,243	14,181	13,305	12,568	11,139

Table 2
For 8" WC - 10.5" WC initial supply pressure
Maximum natural gas delivery capacity (3.0" Pressure Drop)

Values in Table are in Cubic Feet of Gas per Hour (0.60 Specific Gravity, 3.0" Pressure Drop, 8.0" WC or greater supply pressure, inlet pressure less than 2 psi). Contact your gas supplier for BTU / Cubic Foot ratings. For simplification of your calculations, 1 Cubic Foot of Gas is approximately equivalent to 1000 BTU

Venting Type	Residential Models											Commercial Models			
	NR83	NR98		NRC661	NRC711	NRC98	NRC111	EZTR40	EZ98 EZ111 EZ71	NRCB	NRCR	NCC199	NC199	NCC300	NC380
	DVC	DVC	SV	DV	DV	DV	DV	SVF	DV	DV	DV	CDV	DVC	DV	SV
4" CAT III Vent			✓												
5" CAT III Vent														✓	✓
Concentric SS Vent	✓	✓											✓		
2" Flex Pipe							✓	✓			✓				
2" PVC Vent								✓	✓	✓	✓				
3" PVC Vent				✓	✓	✓	✓	✓	✓	✓	✓				
4" PVC Vent					✓	✓		✓			✓			✓	

Length (including fittings)

Pipe Size	10'	20'	30'	40'	50'	60'	80'	100'	125'	150'	175'	200'
	3m	6m	9m	12m	15m	18m	24m	30m	38m	45m	53m	60m
1/2"	291	200	160	137	122	110	101	94	89	84	74	67
3/4"	608	418	336	287	255	231	212	197	185	175	155	140
1"	1,150	787	632	541	480	434	400	372	349	330	292	265
1 1/4"	2,350	1,620	1,300	1,110	985	892	821	763	716	677	600	543
1 1/2"	3,520	2,420	1,940	1,660	1,480	1,340	1,230	1,140	1,070	1,010	899	814
2"	6,790	4,660	3,750	3,210	2,840	2,570	2,370	2,200	2,070	1,950	1,730	1,570

Table 3
Maximum Undiluted Propane (LP) Delivery Capacity in Thousands of BTU/h (0.5" WC Pressure Drop) [Schedule 40 Metallic Pipe]

For reference only. Please consult gas pipe manufacturer for actual pipe capacities.

Accessory Compatibility Chart

Accessories	Part #	Residential Models														Commercial Models										
		EZ Series Pro		NR501	NR662	NR83		NR98		NRC661		NRC711		NRC98		NRC111		NRCR Pro	NRCB	EZTR40	NCC300		NCC199 Pro	NC199		NC380
		DV	OD	OD	DVC	OD	DVC	SV	OD	DV	OD	DV	OD	DV	OD	DV	OD	DV	SV	SV	DV	OD	CDV	DVC	OD	SD
RC Outdoor Junction Box	0700757	✓	✓	✓					✓	✓	✓	✓	✓	✓	✓	✓				✓	✓	✓	✓	✓	✓	
Building Management System	BMS1-SC-401-6M																			✓	✓	✓	✓	✓	✓	
Crossover Valve Bypass Kit	CSV-BPK																									
Crossover Valve	cCS-V																									
EZTR Optional Diffuser Kit	EZ2-DK	✓																		✓						
Replacement Cartridge for SS-HB-3	HBC-3	✓	✓	✓	✓	✓	✓	✓	✓	✓	✓	✓	✓	✓	✓	✓	✓	✓	✓	✓	✓	✓	✓	✓	✓	
Lead-Free Isolation Valve Kit	IK-WV-200-5-TH-L	✓	✓	✓	✓	✓	✓	✓	✓	✓	✓	✓	✓	✓	✓	✓	✓	✓	✓			✓	✓	✓		
	IK-WV-200-5-TH-S	✓																				✓				
	IK-WV-300-1-SW-LF																				✓	✓			✓	
	IK-WV-300-1-TH-LF																				✓	✓			✓	
Manifold Kit	MK-NRCB-1																			✓						
Multi-Rack System	MR-2						✓	✓	✓											✓	✓	✓	✓	✓	✓	
Condensate Neutralizer Kit	NC-1W	✓								✓	✓	✓	✓	✓	✓	✓	✓	✓	✓	✓	✓	✓	✓	✓	✓	
	NT20A																				✓	✓	✓	✓	✓	
Wireless Adapter	NWC-ADAPTER	✓	✓	✓	✓	✓	✓	✓	✓	✓	✓	✓	✓	✓	✓	✓	✓	✓	✓	✓	✓	✓	✓	✓	✓	
Pipe Cover	PC-1S		✓	✓							✓	✓														
	PC-1S-Silver		✓	✓							✓	✓														
	PC-2S				✓	✓			✓																	
	PC-2S-GRY																							✓		
	PC-2S-Silver				✓		✓	✓																		
	PC-3S													✓	✓											
	PC-4S-SUS																								✓	
	PC-5S-GRY																							✓		
	PC-5S-Silver				✓		✓																			
	PC-7S																								✓	
	PC-10S																									
PC-11S	✓																									
Universal Concentric Vent Termination Kit	PVC-UCVK	✓								✓	✓	✓	✓	✓	✓	✓	✓	✓	✓							
2" PVC Concentric Termination	PVC-2CT	✓																								
3" PVC Concentric Termination	PVC-3CT	✓								✓	✓	✓	✓	✓	✓	✓	✓	✓								
Low Profile Vent (2")	PVC-2LPT	✓																								
Low Profile Vent (3")	PVC-3LPT	✓								✓	✓	✓	✓	✓	✓	✓	✓	✓								
Quick Connect Cable ²	QC-1																								✓	
	QC-2	✓			✓	✓	✓	✓	✓					✓	✓	✓	✓	✓	✓	✓	✓	✓	✓	✓	✓	
Remote Controller	QMEJ007																								✓ ³	
Recess Box	RB-510		✓	✓																						
	RB-700-1				✓			✓																	✓	
	RB-900-1													✓	✓											
Remote Controller	RC-7651M-A	✓ ³	✓ ³	✓ ³	✓ ³	✓ ³	✓ ³	✓ ³	✓ ³	✓ ³	✓ ³	✓ ³	✓ ³	✓ ³	✓ ³	✓ ³	✓ ³	✓ ³	✓ ³	✓ ³	✓ ³	✓ ³	✓ ³	✓ ³		
	RC-9018M																				✓ ³	✓ ³	✓ ³	✓ ³	✓ ³	
Remote Controller Cord	RC-CORD10	✓	✓	✓		✓ ¹	✓ ¹	✓ ¹	✓	✓	✓	✓	✓ ¹	✓ ¹	✓ ¹	✓ ¹	✓			✓	✓	✓	✓	✓	✓ ¹	
	RC-CORD26	✓	✓	✓		✓	✓	✓	✓	✓	✓	✓	✓	✓	✓	✓	✓	✓	✓	✓	✓	✓	✓	✓	✓	
System Controller	SC-401-6M-EXT																						✓ ⁴	✓ ⁴		
	SCU-401-24M																								✓ ⁴	
	SCU-401-12M																								✓ ⁴	
	SC-401-6M																								✓ ⁴	
Service Kits	SPK-EZ3																									
	SPK-EZ4	✓																								
	SPK-EZ5	✓																								
	SPK-NRCB2																								✓	
Scale Shield Water Treatment	SS-HB-3	✓	✓	✓	✓	✓	✓	✓	✓	✓	✓	✓	✓	✓	✓	✓	✓	✓	✓	✓	✓	✓	✓	✓	✓	
2" SV Conversion Kit	SV-CK-2-1	✓ ³																							✓ ³	
3" SV Conversion Kit	SV-CK-3-1									✓ ³	✓ ³	✓ ³	✓ ³													
4" DV to SV Conversion Kit	SV-CK-4																								✓ ³	
Outdoor Vent Cap	VC-6-1	✓																								
Wireless Push Button Kit	WLB																								✓ ³	
Motion Sensor	WLB-MS																								✓ ³	
Extra Transmitter for WLB	WLB-ET																								✓ ³	

¹Included w/ heater purchase
²Two units required
³Must be installed indoors
⁴Two or more units required

Accessories

All Noritz accessories are engineered for use with Noritz Tankless Heaters



DSCL-KIT

Noritz Descale Kit

Model Number	Qty	Description
DSCL-KIT	1	Noritz Descale Kit includes: - 5 gal. bucket w/ lid (qty 1) - Submersible pump (qty 1) - 5 ft. hoses (qty 2)



MR-2

Commercial Multi-Rack System

Model Number	Qty	Description
MR-2	1	Commercial multi-rack system ¹

¹Fits 2 heaters, front and back
 Refer to page 30 for complete accessories compatibility chart.



NC-1W / NT20A

Condensate Neutralizer Kit

Model Number	Qty	Description
NC-1W	1	Residential condensate neutralizer kit for NRC111, NRC98, NRC711, NRC661, EZTR40, EZ71, EZ98, EZ111, NRCB, and NRCR
NT20A	1	Commercial condensate neutralizer kit for NC199, NCC199, NCC199CDV Pro, and NCC300 series

IK-WV-200-5-TH-L

(Long Body)



IK-WV-200-5-TH-S

(Short Body)



IK-WV-300-1-SW-LF

IK-WV-300-1-TH-LF



IK-WV

Isolator Valve Kit

Model Number	Qty	Description
IK-WV-200-5-TH-L	1	Lead free 3/4" iso valve kit w/ male 200K BTU pressure relief valve (Long Body)
IK-WV-200-5-TH-S	1	Lead free 3/4" iso valve kit w/ male 200K BTU pressure relief valve (Short Body)
IK-WV-300-2-SW-LF	1	Lead free 1" sweat iso valve kit with male 500K BTU Pressure Relief Valve for NC380 & NCC300
IK-WV-300-2-TH-LF	1	Lead Free 1" threaded iso valve kit with male 500K BTU; Pressure Relief Valve for NC380 & NCC300



MK-NRCB-1

Manifold Kit

Model Number	Qty	Description
MK-NRCB-1	1	Manifold kit for NRCB model

Accessories

PC-#

Pipe Cover



Model Number	Qty	Description
PC-1S	1	Pipe Cover (NRC661, NRC711, NR501, NR662)
PC-1S-Silver (New Finish)	1	Silver Pipe Cover (NR501-OD, NR662-OD)
PC-2S	1	Pipe Cover (NR98SV/OD, NR830D)
PC-2S-GRY	1	Stone gray pipe cover for NC1990D
PC-2S-Silver (New Finish)	1	Silver Pipe Cover (NR98SV/OD, NR830D)
PC-3S	1	Pipe cover (NRC98DV/OD & NRC111DV/OD)
PC-4S-SUS	1	Stainless Steel PC for NC380SV
PC-5S	1	Pipe cover for NR98DVC & NR83DVC
PC-5S-GRY	1	Stone gray pipe cover for NC199DVC
PC-7S	1	Pipe cover for NCC300 OD/DV
PC-10S	1	Pipe cover for NRCR (GQ60), EZ Series (GQ60), and NCC199CDV (GQ60)
PC-11S	1	Pipe cover for NRCR Pro, EZ Pro, and CDV Pro

RC-#

Remote Controller



Model Number	Qty	Description
RC-7651M-A	1	Remote controller for current residential models
RC-7651M	1	Remote controller for NRC661, NRC711, NR83, NR98, NRC98, and NRC111
RC-9018M	1	Commercial remote controller (Excluding NC380) / NRCR (GQ60) controller (For timer control)

RC-CORD#

Remote Controller Cord



Model Number	Qty	Description
RC-CORD10	1	10 feet in length
RC-CORD26	1	26 feet in length

QC-#

Quick Connect Cable



Model Number	Qty	Description
QC-1	1	Quick connect cable for NC380 ¹
QC-2	1	Quick connect cable (NR83, NR98, NRC111, NRC98, NCC199, NCC199CDV Pro, NC199, EZ98, EZ111, NCC300, NRCR) ¹

¹Up to 2 units only

RB-#

Recess Box



Model Number	Qty	Description
RB-510	1	Recess box for NRC661, NR501, NR662, NRC711
RB-700-1	1	Recess box for NR98 and NR83
RB-900-1	1	Recess box for NRC111 and NRC98

RPK-#

External Recirculation Pump



Model Number	Qty	Description
RPK-EXT-P	1	External recirculation pump kit WITHOUT remote (For Pro Units)
RPK-EXT*	1	External recirculation pump kit with remote ² (Condensing / Non-Condensing) ¹

¹Applicable Models (both LP and NG):

NR83, NR98, NR98, NRC98, NRC111, EZ71, EZ98, EZ111, EZTR50, EZTR75, NCC199

² Includes Commercial Remote for daily pump scheduling

NOTE: Single use installations only, not compatible with quick connect installations.

Outdoor Models:

NR830D, NR980D, NRC980D, NRC1110D, EZ98 /EZ111 (with Outdoor Vent Cap)

* RPK must be installed INDOORS ONLY

SC-#

System Controller



Model Number	Qty	Description
SC-401-6M	1	System controller for up to 6 units for the NCC199, NCC300 & NC380 series
SCU-401-12M	1	System controller for up to 12 units for the NCC199, NCC300 & NC380 series
SCU-401-24M	1	System controller for up to 24 units for the NCC199, NCC300, & NC380 series
SC-401-6M-EXT	1	System controller for up to 6 units for the NC199

SPK-EZ5

Service kit for updated EZ /NRCR /CDV Pro models



Model Number	Qty	Description
SPK-EZ5 NEW	1	Service and parts kit for all EZ Series / NRCR / NCC199CDV models
SPK-EZ4 Also Available	1	Service and parts kit for EZ Series Pro / NRCR Pro / CDV Pro

SPK-#

Service Kits



Model Number	Qty	Description
SPK-EZ3	1	Service and parts kit for EZ Series / NRCR Series / NCC199 Series
SPK-1	1	Service parts kit starter
SPK-3	1	Service kit for low NOx 120 kbtu - 157 kbtu models
SPK-4	1	Service kit for low NOx - 180 kbtu - 199 kbtu models
SPK-5	1	Service kit for larger 2nd generation 194 kbtu - 380 kbtu models
SPK-6	1	Service kit for smaller 2nd/3rd generation under 199 kbtu models
SPK-7	1	Service kit for larger 3rd generation 199 kbtu - 250 kbtu models

WLB-ET

Extra Transmitter for WLB for NRCR

1 x Transmitter



Model Number	Qty	Description
WLB-ET	1	Additional transmitter for WLB on-demand button kit. (WLB Required; Sold Separately)

Accessories

SS

Scale Shield Water Treatment



Model Number	Qty	Description
SS-HB-3	1	Water treatment for all residential models and combi models w/ 1 unit
HBC-3	1	Replacement cartridge for SS-HB-3

SPK-NRCB2

Service kit for NRCB models



Model Number	Qty	Description
SPK-NRCB2	1	Service and parts kit for NRCB combination boiler models.

WLB

Wireless On-Demand Button kit for the NRCR



Model Number	Qty	Description
WLB	1	Wireless Push Button Kit. (Includes 1 receiver and 2 transmitters)

WLB-MS

Wireless Motion Sensor for NRCR

1 x Wireless Motion Sensor



Model Number	Qty	Description
WLB-MS	1	Wireless Motion Sensor (WLB Required; Sold Separately)

PVC Vent Accessories



PVC-#CT

PVC Concentric Horizontal Termination Kit

Model Number	Qty	Description	L1	L2	L3
PVC-2CT	1	2" PVC Concentric Termination	41"	7.38"	3.5"
PVC-3CT	1	3" PVC Concentric Termination	48"	8.75"	4.5"

Note:
For 4", use IPEX #196021

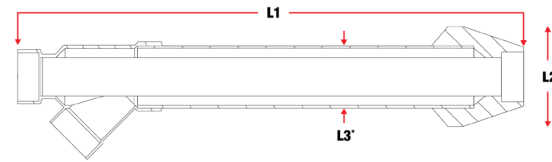

*Installation cutout should be at least 1/2" larger than dimension L3

DIAGRAM:
Horizontal Configuration

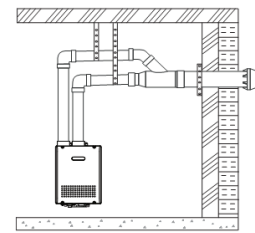
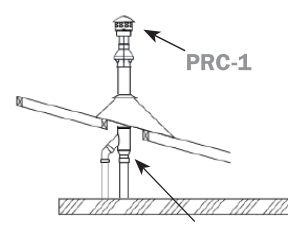

DIAGRAM:
Vertical Configuration



PVC-3CT (3")
or
PVC-2CT (2")



PVC-UCVK

Universal Concentric Vent Termination Kit

Model Number	Qty	Description	L1	L2	L3
PVC-UCVK	1	Universal Concentric Vent Termination Kit	31"	20"	4.5"

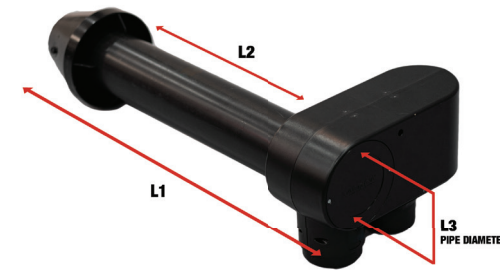

PVC-#LPT

Low Profile Vent

Model Number	Qty	Description	L1	L2
PVC-2LPT	1	Low Profile Vent (2")	2.37"	2.37"
PVC-3LPT	1	Low Profile Vent (3")	3.50"	3.38"

PVT-HL

Plastic Horizontal Termination

Model Number	Qty	Description	L1	L2
PVT-HL ²	6	2" PVC ²	7.5"	2.0"
PVT-HL ¹	6	3" PVC	7.5"	2.0"
PVT-HL ¹	6	4" PVC	7.5"	2.0"

¹ Not approved for Canada
² When using on 2" PVC, must use a 2" reducer

PVC Vent Accessories

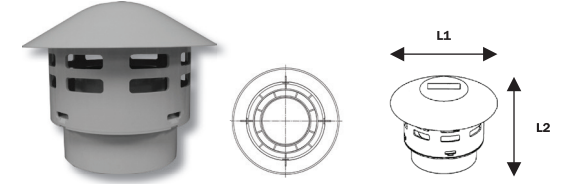

PRC-1

Plastic Rain Cap

Model Number	Qty	Description	L1	L2
PRC-1 ²	1	2" (EZ71, EZ98, EZ111, NCC199)	7.7"	6.2"
PRC-1 ¹	1	3" (For NRC111, NCC199, NRC98, NRC711, NRC6611, NRCB, & NCC199)	7.7"	6.2"
PRC-1 ¹	1	4" (For NRC111, NCC199, NRC98, NCC300)	7.7"	6.2"

¹ Not approved for Canada
² Not approved for Canada; Needs 3"x2" bushing

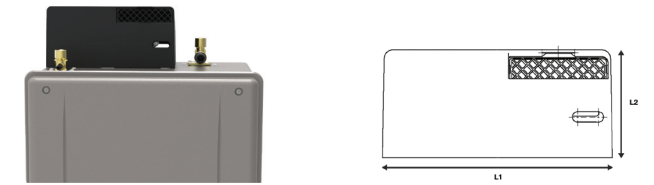

VC-#

Outdoor Vent Cap

Model Number	Qty	Description	L1	L2
VC-6-1 ¹	1	Outdoor vent cap for DV Models (EZ, NRCR, NCC199)	10.9"	5.1"
VCK-NRCB	1	Outdoor conversion kit for DV models including NRCB boiler	10.4"	5.3"
VC-132	1	Outdoor vent cap for SV Model including NC380	18.9"	7.6"

¹ Not approved for Canada

CR#-PVC

Cosmetic Ring

Model Number	Qty	Description
CR3-PVC	1	3" Cosmetic ring for PVC
CR4-PVC	1	4" Cosmetic ring for PVC

SV-CK-2-1

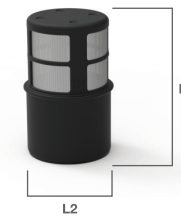

SV-CK-3-1

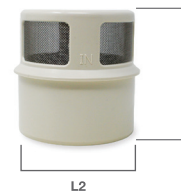

SV-CK-#-1

2" and 3" SV Conversion Kit

Model Number	Qty	Description	L1	L2
SV-CK-2-1	1	2" SV Conversion Kit	3.88"	2.37"
SV-CK-3-1	1	3" SV Conversion Kit	3.56"	3.48"
SV-CK-4	1	4" DV to SV Conversion Kit (NCC300)	2.85"	2.96"



VT#-PVCS

PP or Stainless Steel Bird Screen for PVC Termination

Model Number	Qty	Description	L1	L2
VT2-PVCS	1	2" Polypropylene (White)	2"	3"
VT3-PVCS	1	3" Stainless Steel	2.8"	3"
VT4-PVCS	1	4" Stainless Steel	4.5"	3"

Single Wall Vent

VP# - #STR

Rigid vent pipe stainless steel single-wall

Model Number	Qty	Venting Series	L1	L2
VP4-6STR	6	4" SUS	2.1"	6"
VP4-12STR	6	4" SUS	2.1"	12"
VP4-24STR	6	4" SUS	2.1"	24"
VP4-36STR	6	4" SUS	2.1"	36"
VP4-48STR	6	4" SUS	2.1"	48"
VP5-6STR	6	5" SUS	2.7"	6"
VP5-12STR	6	5" SUS	2.7"	12"
VP5-24STR	6	5" SUS	2.7"	24"
VP5-36STR	6	5" SUS	2.7"	36"
VP5-48STR	6	5" SUS	2.7"	48"

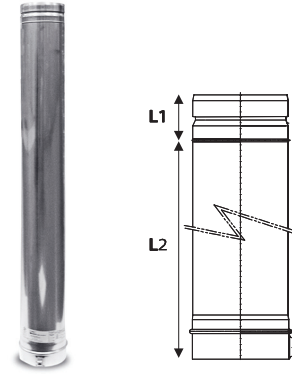

VP# - #ADJ

Adjustable vent pipe stainless steel single wall

Model Number	Qty	Venting Series	L1	L2
VP4-9.4ADJ	6	4" SUS	2.1"	9.4"
VP4-13.4ADJ	6	4" SUS	2.1"	13.4"
VP4-21.4ADJ	6	4" SUS	2.1"	21.4"
VP4-60ADJ	6	4" SUS	2.1"	60"
VP5-9.4ADJ	6	5" SUS	2.7"	9.4"
VP5-13.4ADJ	6	5" SUS	2.7"	13.4"
VP5-21.4ADJ	6	5" SUS	2.7"	21.4"

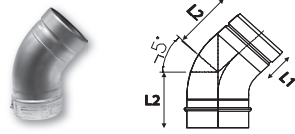
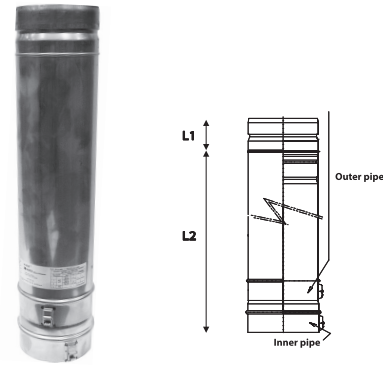

VP#-45ELB

45° Vent pipe elbow stainless steel single-wall

Model Number	Qty	Description	L1	L2
VP4-45ELB	6	4" SUS	2.1"	4.0"
VP5-45ELB	6	5" SUS	2.7"	5.4"

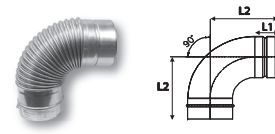

VP#-90ELB

90° Vent pipe elbow stainless steel single wall

Model Number	Qty	Description	L1	L2
VP4-90ELB	6	4" SUS	2.1"	6.2"
VP5-90ELB	6	5" SUS	2.7"	7.9"



VP#-18FLEX

Semi-flexible vent pipe stainless steel single wall

Model Number	Qty	Description	L1	L2
VP4-18FLEX	6	4" SUS	2.1"	16.75"
VP5-18FLEX	6	5" SUS	2.1"	16.75"

4" SUS	For NR98SV
5" SUS	For NC380 Series
Concentric SUS	For DVC Series

Single Wall Vent Accessories

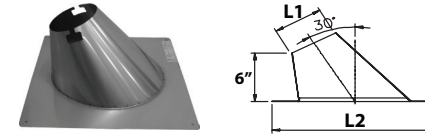

ARF#

Angled roof flashing stainless steel single-wall

Model Number	Qty	Description	L1	L2
ADJRF34 ²	1	4" ¹	5.7"	14.3"
ARF5	1	5" SUS	5.8"	7.8" - 14"
CARF-1	1	Concentric SUS ¹	5.8"	7.8" - 14"

¹ Galvalume for ADJRF34
² 0-45 degree roof pitch

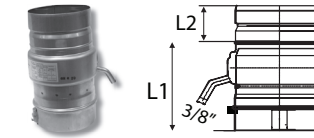

DT#-V

Vent pipe vertical drain tee stainless steel single wall

Model Number	Qty	Description	L1	L2
DT4-V	6	4" SUS	5.1"	2.1"
DT5-V	6	5" SUS	6.2"	2.1"

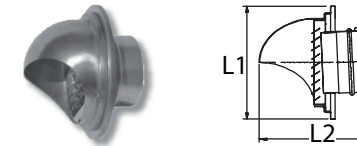

VT#-SH

Vent pipe termination w/ hood stainless steel single-wall vent pipe

Model Number	Qty	Description	L1	L2
VT4-SH	6	4" SUS	7.4"	6.1"
VT5-SH	6	5" SUS	7.4"	6.6"

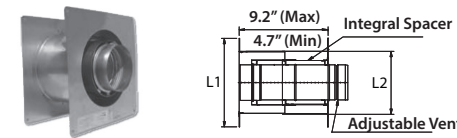

WT#

Vent pipe wall thimble stainless steel single-wall

Model Number	Qty	Description	L1	L2
WT4	1	4" SUS	10"	7"
WT5	1	5" SUS	12.2"	10.7"

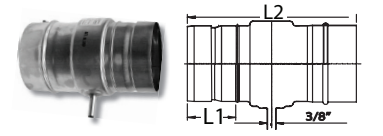

DT#

Vent pipe horizontal drain tee stainless steel single wall

Model Number	Qty	Description	L1	L2
DT4	6	4" SUS	2.1"	7.2"
DT5	6	5" SUS	2.1"	8.0"



SS to PVC Vent Adapters

4" Adapter

Model Number	Qty	Description
VK4-PVC2SUS	1	Convert from 4" for PVC to 4" single-wall stainless steel venting
PVC4XVP5-ADAPT	1	4" for PVC to 5" stainless steel vent adapter (NCC300)

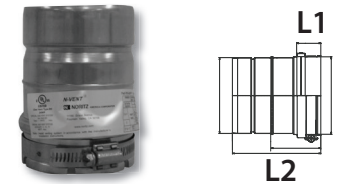

VP4-ADAPT-1

Appliance adapter vent pipe stainless steel single-wall

Model Number	Qty	Venting Series	L1	L2
VP4-ADAPT1*	6	4" SUS	1.2"	4.9"

*Only used with non-Noritz units to use with our VP4 venting.

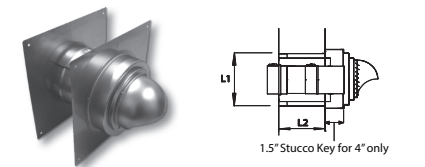

WT4-H-#

Adjustable wall thimble w/ termination stainless steel single-wall vent pipe

Model Number	Qty	Description	L1	L2
WT4-H-8-1	1	4" SUS	5.8"	4.1" - 7.8"
WT4-H-14-1	1	5" SUS	5.8"	7.8" - 14"

Single Wall Vent Accessories

BG-DVC-#

Stainless Steel Bug Guard



Model Number	Qty	Venting Series	Description
BG-DVC-H	1	Concentric SUS	Horizontal
BG-DVC-V	1	Concentric SUS	Vertical

Image and drawing shown: BG-DVC-V

FP-5-OUT

Stainless Steel Face Plates



Model Number	Qty	Venting Series	L1	L2
FP-5-OUT	1	Concentric SUS	6.7"	8.7"

4" SUS	For NR98
5" SUS	For NC380 Series
Concentric SUS	For DVC Series

RC#

Venting Pipe Rain Cap

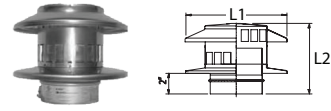

Model Number	Qty	Venting Series	L1	L2
RC4	6	4" SUS	7.8"	6.6"
RC5	6	5" SUS	11"	7.2"

SCR#

Storm Collar Ring

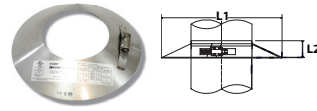

Model Number	Qty	Venting Series	L1	L2
SCR4-1	1	4"	9"	6"
CSCR-1	6	Concentric and 5" SUS	9.1"	4"

4" SUS	For NR98
5" SUS	For NC380 Series
Concentric SUS	For DVC Series

SS5-#

5" And Concentric Sus Venting Series Stainless Steel Support Straps

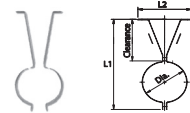

Model Number	Qty	Clearance	L1	L2
SS5-1	5 Sets	1"	6.8"	6"
SS5-2	5 Sets	2"	7.8"	6"
SS5-4	5 Sets	4"	9.8"	6"
SS5-6	5 Sets	6"	11.8"	6"

CR#

Stainless Steel Cosmetic Ring



Model Number	Qty	Venting Series	L1	L2
CR4-SUS	1	4" SUS	7.2"	4.3"
CR5-SUS	1	Concentric and 5" SUS	9.9"	5.4"

FS#

Stainless Steel Fire Stop

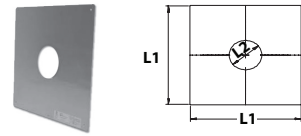

Model Number	Qty	Venting Series	L1	L2
FS4	6	4" SUS	18"	4.4"
FS5	6	5" SUS	20.4"	5.4"

SC#

Stainless Steel Support Clamp

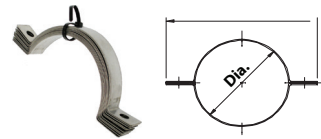

Model Number	Qty	Venting Series	Diameter
SC4	5 Sets	4" SUS	6"
SC5	5 Sets	5" SUS	7"

SS4-#

4" Sus Venting Series Stainless Steel Support Straps

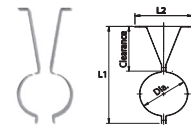

Model Number	Qty	Clearance	L1	L2
SS4-1	5 Sets	1"	5.7"	4.7"
SS4-2	5 Sets	2"	6.6"	4.7"
SS4-4	5 Sets	4"	8.7"	4.7"
SS4-6	5 Sets	6"	10.7"	4.7"

VK4-V1

Vent Pipe Vertical Kit (Stainless steel single wall)

Model Number	Qty	Venting Series
VK4-V1	1	4" SUS

4" SUS	For NR98
--------	----------

N-Vent Vertical Vent Kit VK4-V1

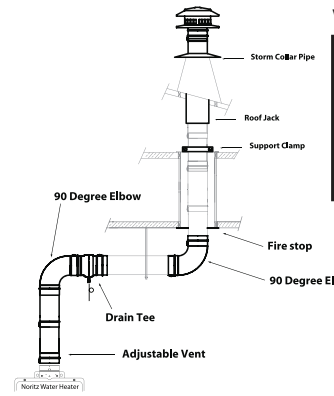

Vertical Kit Contains:

Description	Part Number	Quantity
Drain Tee	DT4	1
90 Degree Elbow	VP4-90ELB	2
Firestop	FS4	1
Support Clamp	SC4	1
Roof Jack	RJ4	1
Storm Collar Pipe	SCP4	1
Rain Cap	RC4	1
9"- 13.4" Adjustable Vent	VP4-13.4ADJ	1



VK4-H-#-1

Vent Pipe Horizontal Kit (Stainless steel single wall)

Model Number	Qty	Venting Series
VK4-H-8-1	1	4" SUS ¹

VK4-H-14-1	1	4" SUS ²
------------	---	---------------------

¹ 4.1 - 7.4" Wall thickness
² 7.4 - 14" Wall thickness

4" SUS	For NR98
--------	----------

N-Vent Horizontal Vent Kit VK4-H-*

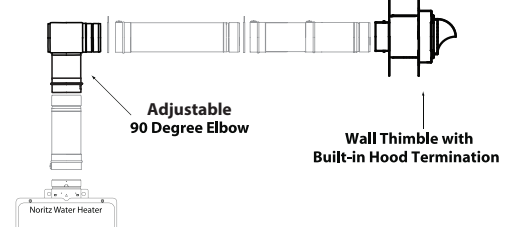

Horizontal Kit Contains:

Description	Part Number	Quantity
Wall Thimble with Built-in Hood Termination	WT4-H-#-1 (# Based on wall thickness)	1
Vertical Adjustment Range (7.5" - 11")	VP4-90ADJELB	1

Wall Thickness	Venting Kit Number
4.1" - 7.4"	VK4-H-8-1
7.4" - 14"	VK4-H-14-1



Concentric Venting

Build your own kit Horizontal Concentric Venting

Customize and design your own concentric venting setup with our available venting accessories.

No	1	2	3	4	5	6	7
Description	Straight Bird Screen w/ Outer Plate	90° Adj w/ Wall Flange	Straight Vent Pipe w/ Wall Flange	Straight	Adjustable	45/90 Degree	M2M
Part Number	CVT-S	CWF-90ELB	CWF-F	CVP-4/12/24/36STR	CVP-11/16/40ADJ	CVP-45/90ELB	CVP-ADAPT-M2M

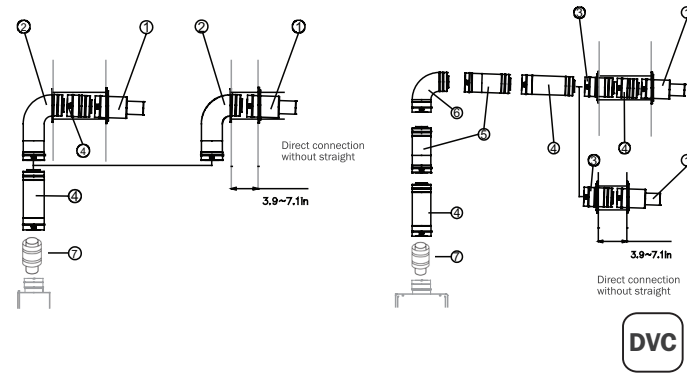

CVP-#STR

Rigid Vent Pipe Stainless Steel Double-Wall

Model Number	Qty	Venting Series	L1
CVP-4STR	5 Sets	Concentric SUS	3.3"
CVP-12STR	5 Sets	Concentric SUS	11.8"
CVP-24STR	5 Sets	Concentric SUS	23.6"
CVP-36STR	5 Sets	Concentric SUS	35.4"



CVP-45ELB

45° Vent Pipe Elbow - Stainless Steel Double-Wall

Model Number	Qty	Venting Series	L1	L2
CVP-45ELB ¹	6	Concentric SUS	5.3"	2.2"

¹ Non-Flexible



CVP-90ADJELB

90° Adjustable Vent Pipe Elbow - Stainless Steel Double-Wall

Model Number	Qty	Venting Series	L1	L2
CVP-90ADJELB	6	Concentric SUS	12.6 - 15.8"	4.9"



CVP-#ADJ

Adjustable Vent Pipe Stainless Steel Double-Wall

Model Number	Qty	Venting Series	L1
CVP-11ADJ	6	Concentric SUS	8.3 - 11.2"
CVP-16ADJ	6	Concentric SUS	11 - 16.7"
CVP-40ADJ	6	Concentric SUS	22.8 - 40.6"



CVP-90ELB

90° Vent Pipe Elbow - Stainless Steel Double-Wall

Model Number	Qty	Venting Series	L1	L2
CVP-90ELB ¹	6	Concentric SUS	8.1"	4.9"

¹ Non-Flexible



CWF-90ELB

90° Adjustable Vent Pipe Elbow W/ Wall Flange - Stainless Steel Double-Wall

Model Number	Qty	Venting Series	L1	L2
CWF-90ELB	6	Concentric SUS	12.6 - 15.8"	4.9"

Concentric SUS	For DVC Series
----------------	----------------

Concentric Venting

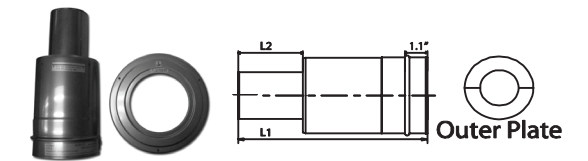

CVT-S

Straight Termination W/ Bird Screen - Stainless Steel Double-Wall Vent Pipe

Model Number	Qty	Venting Series	L1	L2
CVT-S	6	Concentric SUS	11"	3.9"

CRCAI-1-F

Vent Pipe Rain Cap - Stainless Steel Double-Wall

Model Number	Qty	Venting Series	L1	L2
CRCAI-1-F	1	Concentric SUS	10.6"	26.5"



CWF-F

Vent Pipe W/ Wall Flange - Stainless Steel Double-Wall

Model Number	Qty	Venting Series	L1	L2
CWF-F	6	Concentric SUS	2"	8.7"

Note the venting has changed. Before installation, confirm the termination piece ordered on the table below. If a vent termination piece from the "Existing Vent Kit" column is being utilized, a CVP-ADAPT-M2M (Fig 1) adapter must be utilized. If a vent termination from the "New Vent Kit" column is utilized, no adapter is necessary.



	Existing Vent Kit	New Vent Kit
Horizontal	CVK-H CVK-H2 CWF	CVK-H-F CVK-H2-F CWF-F
Vertical	CRCAI-1 CVK-V-1	CRCAI-1-F CVK-V-1-F

CVP-ADAPT-M2M

Concentric Vent Pipe Male To Male - Stainless Steel Double-Wall

Model Number	Qty	Venting Series	L1	L2
CVP-ADAPT-M2M	1	Concentric	5"	5.5"

Note the venting has changed. Before installation, confirm the unit ordered on the table below. If a vent termination piece from the "Existing Unit" column is being utilized, a CVP-ADAPT-F2F (Fig 1) adapter must be utilized. If a vent termination from the "New Unit" column is utilized, no adapter is necessary.



Existing Unit	New Unit
NR83-DVC	NR83DVC (GQ-2457WS-FFA US)
NR98-DVC	NR98DVC (GQ-2857WX-FFA US)
NR981-DVC	NC199DVC (GQ-2857WZ-FFA US)
NC199-DVC	
NC1991-DVC	

CVP-ADAPT-F2F

Concentric Vent Pipe Adapter Female To Female - Stainless Steel Double-Wall

Model Number	Qty	Venting Series	L1	L2
CVP-ADAPT-F2F	1	Concentric	5"	7.5"

Prior heater models. Version 2 venting.

Concentric SUS	For DVC Series
----------------	----------------

HORIZONTAL INSTALLATIONS

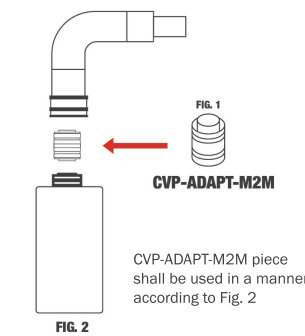

CVP-ADAPT-M2M piece shall be used in a manner according to Fig. 2

VERTICAL INSTALLATIONS

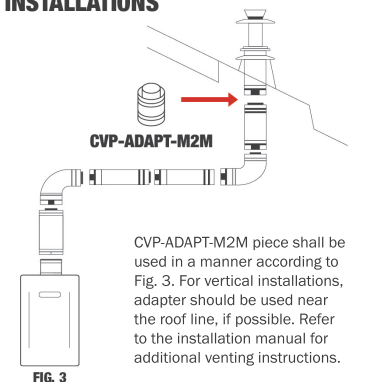

CVP-ADAPT-M2M piece shall be used in a manner according to Fig. 3. For vertical installations, adapter should be used near the roof line, if possible. Refer to the installation manual for additional venting instructions.

HORIZONTAL INSTALLATIONS

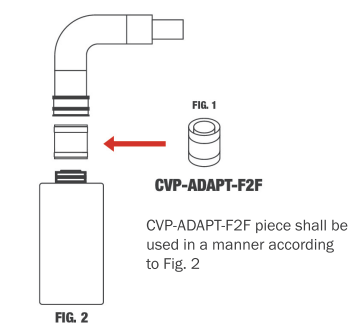

CVP-ADAPT-F2F piece shall be used in a manner according to Fig. 2

VERTICAL INSTALLATIONS

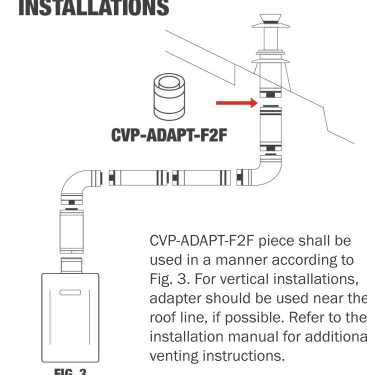

CVP-ADAPT-F2F piece shall be used in a manner according to Fig. 3. For vertical installations, adapter should be used near the roof line, if possible. Refer to the installation manual for additional venting instructions.

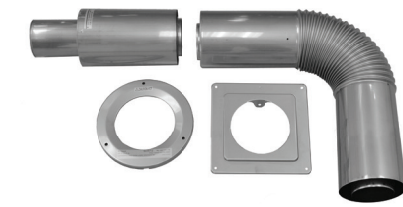

CVK-H-F

Vent Pipe Horizontal Kit - Stainless Steel Double-Wall

Model Number	Qty	Venting Series	L1
CVK-H-F	1	Concentric SUS ¹	8.3 - 11.2"
CVK-H2-F	1	Concentric SUS ²	11 - 16.7"

¹ (5.8 - 13.2" Wall thickness)
² (10.3 - 17.8" Wall thickness)

CVK-V-1-F

Vent Pipe Vertical Kit - Stainless Steel Double-Wall

Model Number	Qty	Venting Series
CVK-V-1-F	1	Concentric SUS ¹

CVK-V-1 Contents		
No	Description	Part Number
1	Concentric Rain Cap	CRCAI-1-F
2	Storm Collar	CSCR-1
3	Adjustable Roof Flashing (0-45 Degrees)	CARF-1

¹10-45° Roof Pitch

CVK-SNRK-F

Vent Pipe Horizontal Snorkel Kit - Stainless Steel Double-Wall

Model Number	Qty	Venting Series
CVK-SNRK-F	1	Concentric SUS

Snorkel Kit (CVK-SNRK) Contents		
PCS	Description	Part #
1	Snorkel case top	SNRK-C1
2	Snorkel case bottom	SNRK-C2
3	Concentric 11" adjustable vent pipe	CVP-11ADJ
4	Concentric 16" adjustable vent pipe	CVP-16ADJ
5	Concentric snorkel termination elbow	CVI-SNRK-90ELB
6	Concentric 90 degree elbow	CVP-90ELB
7	Concentric 90 degree adjustable elbow	CVP-90ADJELB
8	Adjustable support strap	SSS-3ADJ
9	Screw set	S-12
10	Concentric vent pipe, male to male	CVP-ADAPT-M2M

Horizontal - Kits

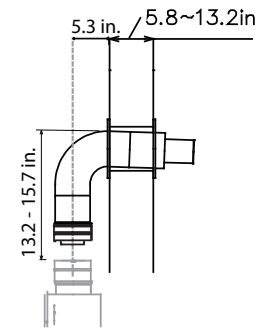

CVK-H-F
Standard Wall Kit
 Includes inner & outer plates
 Wall thickness range from 5.8" to 13.2"

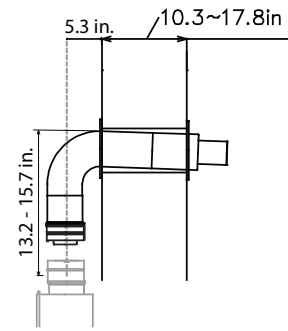

CVK-H2-F
Thick Wall Kit
 Includes inner & outer plates
 Wall thickness range from 10.3" to 17.8"

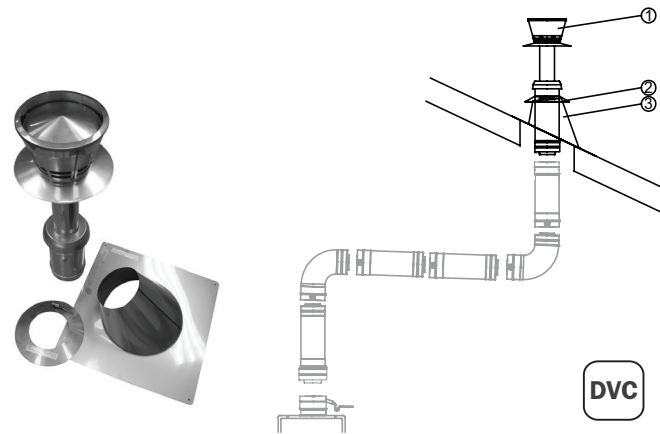

DVC

Snorkel Kit

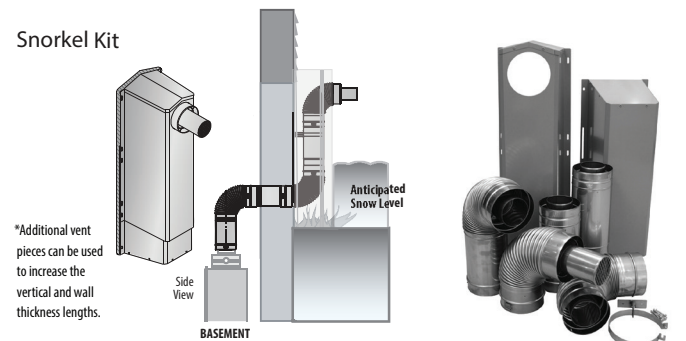

*Additional vent pieces can be used to increase the vertical and wall thickness lengths.

DVC

America's Most Trusted Tankless Manufacturer

Noritz is redefining water heating with cutting-edge technology built for performance, reliability, and efficiency. Backed by world-class customer support, Noritz is the trusted choice for installers and homeowners alike—providing confidence and peace of mind.



New for 2026

Take Control with our Upgraded Pro Line

Our Pro line of flagship tankless has been upgraded with a new full function display, which helps speed up the installation process and gives homeowners and servicers greater access to heater functions, temperature controls, and more.



11160 Grace Avenue
Fountain Valley, CA 92708

Phone:
1-866-766-7489

Tech Support Hours:
Monday - Friday
5am - 5pm PST
Saturday
6am - 3pm PST

Follow us on social media
@NoritzAmerica

Noritz America | www.noritz.com



05/2026 v1.0