

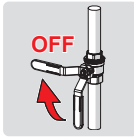

①

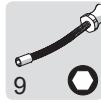

①



②



A B

④

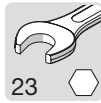

A

⑥



B

⑥

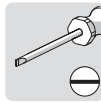

A B

⑨

①

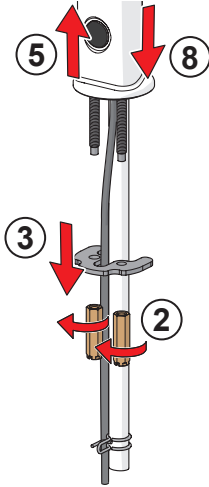

② A

-05/2023 06/2023-

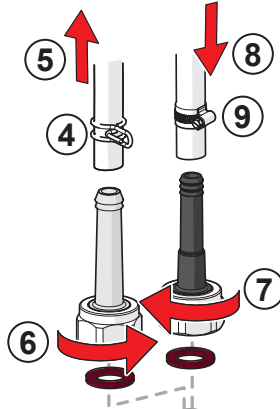

② B

06/2023-



-05/2023

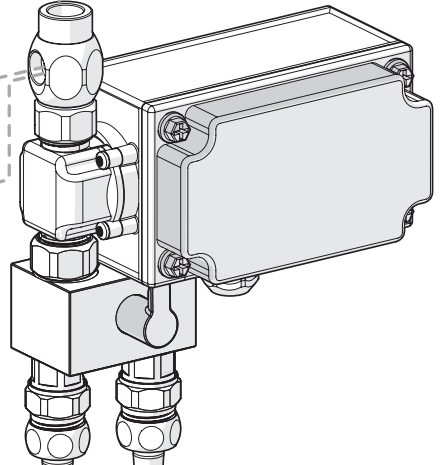
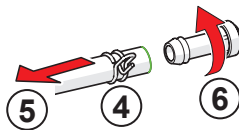

orasgroup



ORAS Ltd.
Isometsäntie 2, P.O. Box 40
FI-26101 Rauma
Finland

Tel. +358 2 83 161
Fax +358 2 831 6300
info.finland@oras.com
www.oras.com

HANSA Armaturen GmbH
P. O. BOX 81 02 40
D-70519 Stuttgart
Sigmaringer Strasse 107
D-70567 Stuttgart
Tel.: +49 711 16 14 0
Fax: +49 711 16 14 368
info@hansa.de
www.hansa.com

943514-02-23