

全能冷熱破壁養生機 | PS810

Intelligent Food Processor

ZH-HK 說明書

EN Instruction Manual

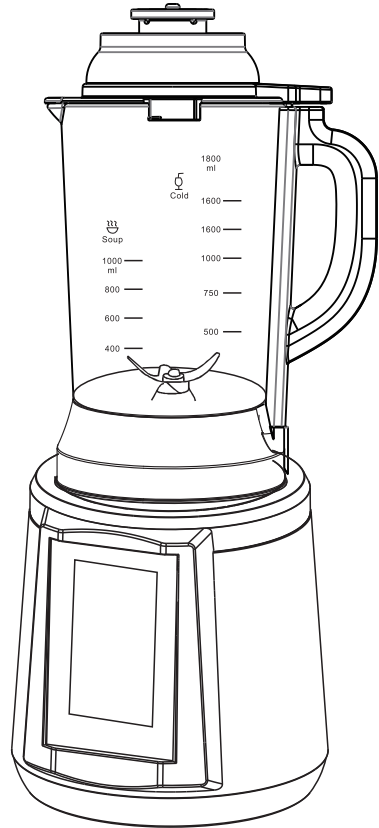

Primada 實康達®

ZH-HK

說明書

2

EN

Instruction Manual

15

感謝您選購寶康達產品——全能冷熱破壁養生機！希望您使用愉快，我們相信這款全新全能冷熱破壁養生機將幫助您烹調更快速方便，讓您重新感受到烹飪的樂趣及擁有不一樣的美食滋味。

使用中如果遇到任何問題，請聯絡我們的售後服務中心，將有專業人員為您解答問題。

如欲了解更多產品資訊，請瀏覽：www.primada.com.hk

本資料產品以實物為準，本公司保留產品更新的權利，如有變動，恕不另行通知。

感謝您的選擇！

目錄

1. 安全注意事項	2
2. 產品組成	4
2.1 包裝隨附物件	4
2.2 技術參數	4
2.3 電器原理圖	5
2.4 組件名稱	5
2.5 各部件說明	6
3. 產品使用	7
3.1 使用流程及操作說明	7
3.2 控制面板說明	9
3.3 啟動應用程序	10
3.4 預約應用程序	11
4. 清洗與保養	12
4.1 清洗與保養方法	12
4.2 主機清洗及保養	12
4.3 杯子清洗及保養	13
5. 疑難排解	14

1. 安全注意事項

**使用電器產品前請仔細閱讀此說明書。
請保管好此說明書。**

使用產品時，請保持一貫的警惕性，遵循以下事項：

- 1.請核對並確認銘牌上所標註的電源，確保產品是在符合標籤的狀態下使用。
- 2.此產品適合於家庭使用，不適合工業或商業使用。
- 3.請勿將產品放在靠近煤氣爐或煮食爐等高溫度環境中使用。
- 4.請勿將產品靠近易燃物品使用，如窗簾或窗紗等。
- 5.請勿將本產品放在易爆物品附件使用，如汽油等。
- 6.請勿將產品放置於不平穩的位置。並需與牆面或其他物品保持一定的距離，以保持機器外圍通風良好，確保機器的使用壽命。
- 7.請勿使用非本產品製造商提供的零部件及配件。
- 8.請勿在無人看管的情況下使用本產品。
- 9.產品不能由8歲以下兒童或精神上有障礙的人使用。若需要使用，請在監護人的監護指導下進行。請不要讓兒童將產品作玩具玩耍。
- 10.請勿將產品主機，電源線及插頭等浸入水中清洗，以免導致故障或引發不可預期的意外。
- 11.請勿使用已有損傷或破裂的電源線或插座。
- 12.請勿讓電源線接觸熱的物體表面。
- 13.若不使用，請將電源關閉，再拔掉插頭。
- 14.拔除插頭時，請勿直接拉扯電源，以免觸電。
- 15.使用的電源線必須可靠接地，且拿出或放上攪拌杯部分前請先切斷電源。
- 16.請勿用濕的手接觸電源線及電器，以免觸電。
- 17.若電源線或插頭出現破損或產品故障時，請將產品送到指定的維修中心修理，切勿自行維修。
- 18.請勿自行拆卸或改裝本產品，以免造成組裝不良而引起不可預測的故障及意外。
- 19.機器在工作過程中，杯體表面溫度會升高，請不要用手直接觸摸，並且不能讓兒童接近或使用。
- 20.請勿將主機或攪拌杯直接放入冰箱或冰櫃中，因為急驟的冷卻及低溫會使杯座內部產生“冷凝水”，容易損壞產品零件導致故障。做某些果蔬飲品後杯蓋有可能染色，屬於正常現象，無損健康。

1. 安全注意事項

21. 攪拌刀刃鋒利，請勿用手觸摸。
22. 使用熱飲功能時，份量控制在攪拌杯800ml-1000ml刻度之間，切勿多放或少放，以免造成燒焦或煮不熟等情況。
23. 產品在工作過程中，杯內液體沸騰後請小心杯嘴噴出的水蒸氣和濺出的熱水。工作過程中切勿揭開杯蓋。
24. 本產品採用高速電機，電源板智能變速控制，粉碎時出現間歇性忽快忽慢的聲音屬正常現象。
25. 使用前，請將接觸電極等擦拭乾淨，防止其具備的功能失效或引起警報。
26. 由於杯蓋內部有感應開關，請勿在產品工作過程中打開杯蓋，導致機器提示警報不工作或溢出。
27. 產品工作過程中請勿添加調味料(砂糖、黑糖等)，以避免調味料在加熱時粘著攪拌杯底部。
28. 接通電源前，請確保杯體，杯蓋及進料口蓋正確安裝。
29. 產品通電時，嚴禁將手或尖銳硬物等伸入杯體內，以免受傷或使產品受損。

2. 產品組成

2.1 包裝隨附物件

隨機配件



PS810

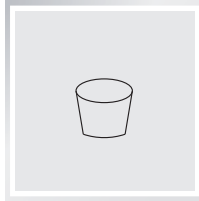

量杯

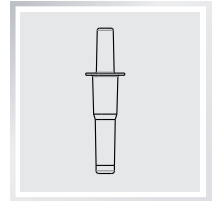

攪拌棒

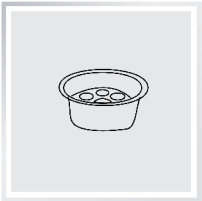

蒸煮架



說明書



產品保用證

2.2 技術參數

產品名稱	全能冷熱破壁養生機
型號	PS810
電源	220-240V~50/60Hz
攪拌功率	800w
加熱功率	800w
容量	1750ml

* 因產品持續改善，原廠保留產品更新的權利，如有變動，恕不另行通知。

2. 產品組成

2.3 電氣原理圖

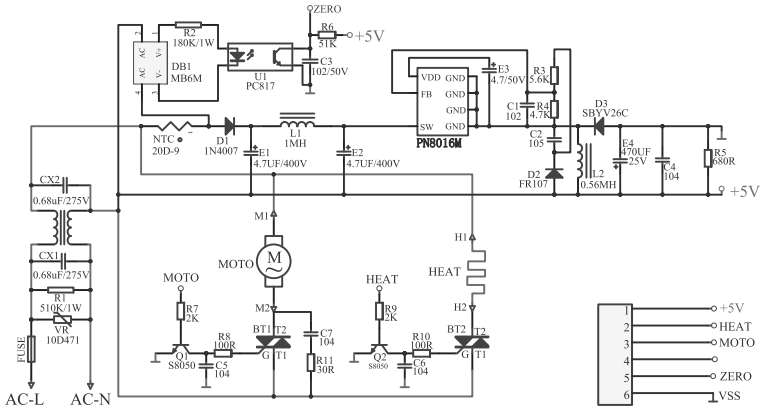

2.4 組件名稱

主機

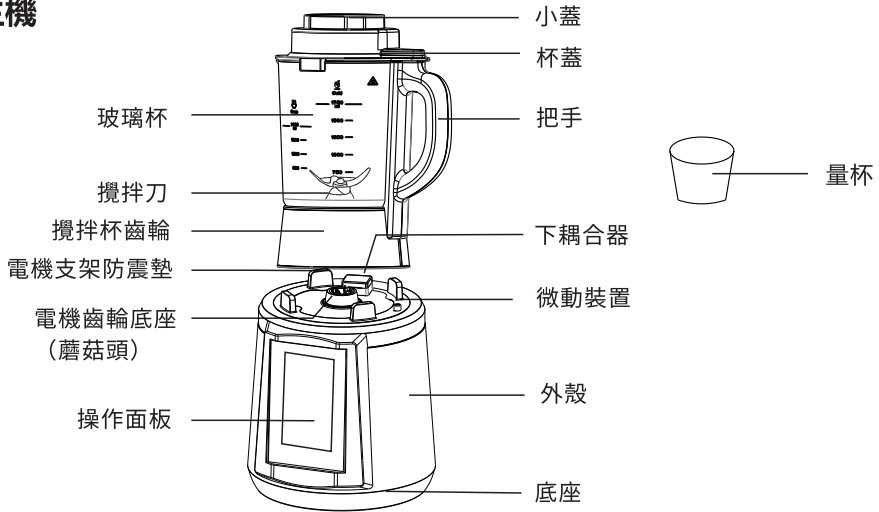

*以上圖片僅供參考，具體產品外觀以及顏色請以實物為準。

*玻璃杯因人為造成損壞，本公司不承擔任何更換，不作保修處理。

2. 產品組成

2.5 各部件說明

1. 杯蓋：採用食品級環保料，配合杯體使用，防止食物溢出。
2. 玻璃杯：採用高硼矽玻璃，底部有加熱裝置，用於盛煮湯液。
3. 電機支架防震墊：採用軟膠材質，用於固定杯體使用。
4. 電機齒輪底座：電機傳遞動力的裝置。
5. 操作面板：可以在此選擇與設定所需要的功能。
6. 小蓋：用於阻擋冒出的蒸汽，防止燙手。
7. 把手：用於取出杯體時握持位置。
8. 攪拌刀：採用不銹鋼材質，用於切割和粉碎各種食物。
9. 下耦合器：提供杯體工作電源，請注意不能直接沖水。
10. 上耦合器：配合下耦合器使用，需對準下耦合器方位壓合。
11. 底座微動裝置：配合杯體上的裝置，接通電源後切勿將手或尖銳硬物按壓。
12. 底座：支撐機器，底部有防震膠腳。
13. 量杯：用於量取食材份量。

3. 產品使用

3.1 使用流程及操作說明

1. 按食譜要求準備好適量食材並切塊放入玻璃杯。

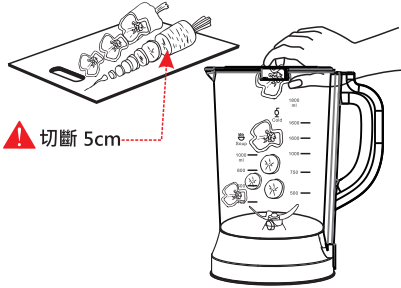

2. 加水不能超過水位最高刻度位置。

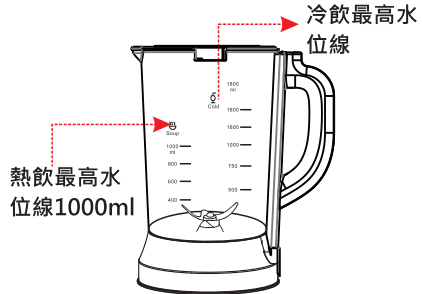

3. 將小蓋逆時針擰緊在杯蓋上。

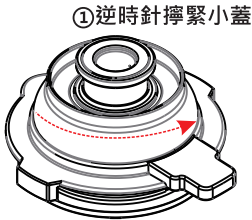

4. 按杯蓋提示方向蓋在玻璃杯上。

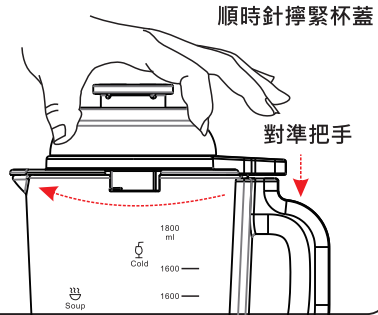

5. 杯體把手對準屏幕正右方安裝在主機上。

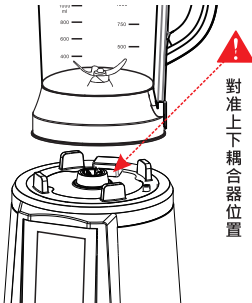

6. 接上電源。



3. 產品使用

3.1 使用流程及操作說明

7. 按“電源開關”鍵進入待機狀態。

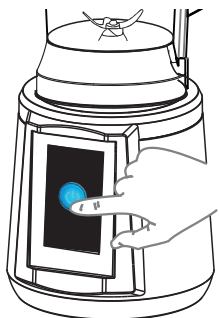

8. 選擇快捷功能自動開始應用程序。



9. 程序完成打開小蓋加入調料。



10. 長按點動程序進行攪拌幾秒。



11. 切斷電源，緩慢取出大杯製作完成。

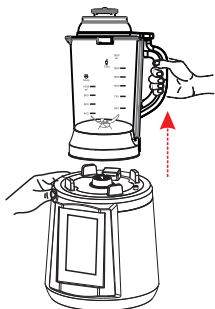

12. 倒入杯即可食用。

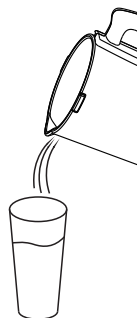

3. 產品使用

3.2 控制面板說明

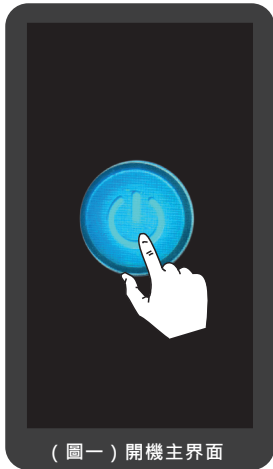

- ▶ 開機操作：接通電源後，控制面板中“電源開關”指示燈亮起。觸摸“電源開關”按鈕，主界面開始顯示，並伴隨2秒激活的提示聲，機器進入待機狀態。（圖一）
- ▶ 關閉操作：在待機狀態下，如沒有選擇任何功能。請輕按主界面上的“關機”圖標關閉，此時屏幕的燈滅。回到通電待機狀態，斷開電源即可。
- ▶ 前往另一個界面：輕按主界面上的“更多功能”按鈕，進入下一個界面。（圖二）
- ▶ 返回到菜單屏幕：輕按應用程序屏幕上的“返回”按鈕，直接返回到上一級菜單屏幕。
- ▶ 打開應用程序：輕按菜單屏幕任意一個應用程序圖標，即可打開該應用程序。（圖三）

3. 產品使用

3.3 啟動應用程序



- ▶ 啟動應用程序：進入"養顏豆漿"應用程序,屏幕將顯示養顏豆漿的食材份量。用戶根據屏幕上的份量要求進行操作,再按"啟動"按鈕即可自動完成。(圖四)
- ▶ 取消應用程序：養顏豆漿功能啟動運行時,如需終止程序,請輕按應用程序屏幕上的"取消"按鈕。(圖五)
- ▶ 退出應用程序：屏幕上出現對話框"此功能正在進行是否退出"提示,再輕按屏幕上的"確認"按鈕即可退到主界面屏幕。(圖六)
- ▶ 完成顯示保溫：機器工作完成後,進入養顏豆漿"保溫"應用界面。界面上顯示30分鐘倒計時的保溫時間,當保溫時間到達30分鐘後自動回到菜單屏幕。(圖七)
- ▶ 取消保溫應用程序：機器進入"保溫"應用程序,如需停止保溫,輕按應用程序屏幕上的"取消"按鈕,回到菜單屏幕。

3. 產品使用

3.4 預約應用程序

- ▶ 預約設定功能: 輕按"養顏豆漿"應用程序內的"預約"按鈕, 進入"預約設置"界面。預約按24小時設置, 用戶根據使用情況自由編輯時間。每按一次"▲" 按鈕增量為1。預約時間設定好後按"確認"按鈕進入程序, 預約程序開始倒計時。待設定的時間達到, 程序按照預先設定好的功能進行工作。



預約應用程序



(圖八) 設置預約示意圖

- 加+

- 減-

分鐘調節框,以分鐘為單位,
可調節0-59分鐘



(圖九) 預約中示意圖

預約中時間以分鐘為單位進行倒計時。
(注: 預約時間不包括功能完成時間)

因部分食材長時間泡水會導致食材變質, 如要設定預約的時間過長時, 不建議用預約功能製作。

含以下食材的食譜不建議用預約功能: 牛奶、魚、蝦米、雞肉、排骨、豬肉、牛肉等。

4. 清洗與保養

4.1 清洗與保養方法

- 產品使用後請及時清洗。
- 清洗產品前，請先拔掉電源插頭。
- 清洗時，替換主機與杯體分開處理。

4.2 主機清洗及保養

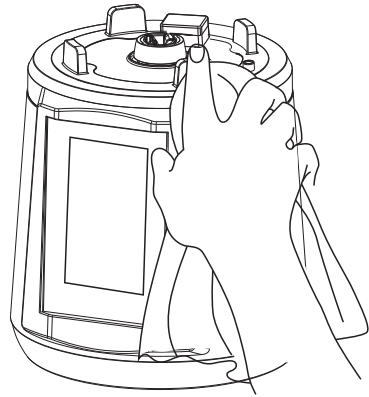
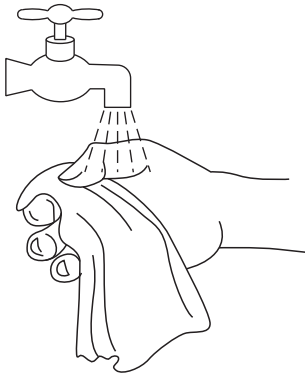

- 可用濕布沾中性洗潔精擦拭，再用乾布擦乾淨。

清潔示範



正確

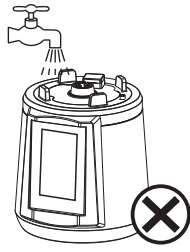

錯誤

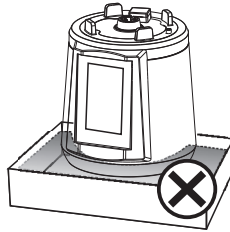

錯誤

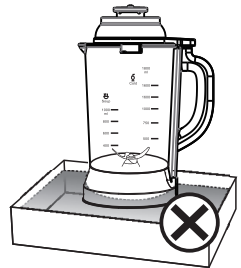

錯誤

4. 清洗與保養

4.3 杯子清洗及保養

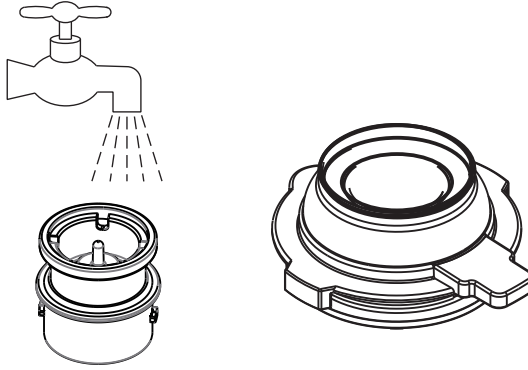

- 杯蓋，小蓋，可直接沖洗，可浸水。
- 清洗後再用乾布擦乾淨，放於陰涼處風乾。
- 清洗時小心刀片傷手。

小心刀片傷手



- 用海綿，清潔刷或抹布擦洗杯體與杯蓋，再倒放晾乾，放入乾燥處。
- 如杯內底部殘留物等難以清洗時，可先以溫熱水浸泡，然後使用清潔刷向同一方向刷拭，再用清水沖洗乾淨。



杯子清潔技巧

可往杯內加入適量水，長按點動功能，自動攪拌清洗。

5. 疑難排解

產品使用過程中，若遇以下情況可對照查詢，自主解決。

故障情況	可能原因	解決辦法
指示燈不亮	指示燈不亮	檢查電源線並保證插好
	杯體與主機沒有安裝到位	將杯體安裝到位
	攪拌杯未放置到位、杯蓋未裝配到位（杯蓋有感應開關）	取下攪拌杯重新放置，將杯蓋裝配到位
機器不能工作	電壓過低	檢查電壓是否過低
	長時間連續工作，電機過熱保護	自然冷卻30分鐘到室溫 按說明書規定的時間操作
	食材過量，超負荷工作	減少加入食材，按說明書或食譜規定的量加入食材
	電機過載保護	待冷卻30分鐘後再使用
食材打不碎	加入食材太大或太少	取出切小塊再加入或按食譜配方操作
	功能選擇錯誤	請按食譜選擇正確的功能
溢出或糊底	加入食材過多	請按食譜配方操作
	杯內未清洗乾淨	請將杯內清洗乾淨再使用
產品工作時有異味	產品初次使用，電機磨合階段屬於正常現象	使用幾次後異味自動消除，建議放置在通風處散味
工作中異常噪音	未正確安裝攪拌杯、杯墊等	關掉機器、取下攪拌杯，檢查杯墊是否有異物，重新放置攪拌杯
只加熱不攪拌 (非預設程序)	機器電路板故障	送修

Congratulations on the purchase of your Primada Intelligent Food Processor ! We hope it brings you many years of satisfaction. We trust the purchase of your new processor will help you for fast/convenient cooking. Let you enjoy cooking and delicious foods.

Should you encounter situations that have not been properly addressed in this Instruction Manual, please contact our Customer Service Center where a technician can address your specific problem or question.

For more information, please visit the official website: www.primada.com.hk

The Company reserves the right to make technological and/or design changes to this product for continuous improvement.

Contents

1. Important Safety Instructions.....	15
2. Package Contents and Technical Specifications.....	16
2.1 Package Contents.....	16
2.2 Technical Specifications.....	16
2.3 Circuit Diagram.....	17
2.4 Product Diagram.....	17
2.5 Parts Description.....	18
3. Operating.....	19
3.1 Operation and Use.....	19
3.2 Control Panel.....	21
3.3 Activate Program.....	22
3.4 Scheduling.....	23
4. Cleaning and Maintenance.....	25
4.1 Instructions for cleaning and maintenance.....	25
4.2 Cleaning and maintenance of motor unit.....	25
4.3 Cleaning and maintenance of blender cup.....	26
5. Troubleshooting.....	27

1. Important Safety Instructions

**READ ALL INSTRUCTIONS BEFORE USING THIS APPLIANCE.
PLEASE KEEP THE INSTRUCTION MANUAL**

When using our product, basic precautions should always be followed, including the following:

1. Please make sure your power supply voltage matches the power voltage marked on rating label.
2. For INDOOR household use ONLY. Do not use the appliance in outdoor, commercial or industrial environments.
3. Do not operate the appliance in high temperature environment, especially next to gas stove.
4. Do not operate the appliance near flammable materials, such as curtains.
5. Do not operate the appliance near explosives, such as gasoline.
6. Place the appliance on flat and heat-resistance surface with good ventilation to maximize its service life.
7. Please always use the original spare parts.
8. Do not use the appliance without attention.
9. This appliance is not intended to be used by children under 8 or anyone lacking knowledge on proper use. Supervision may be necessary. Do not allow children to sit on or play with the appliance.
10. Do not immerse the appliance, power cord and plug into water to avoid malfunction or danger.
11. Do not use the appliance if the power cord or plug is damaged.
12. Do not allow the power cord to contact with hot surface.
13. Disconnect power and remove the plug when not in use.
14. Do not remove power plug by pulling the power cord to avoid electric shock.
15. Power cord must be with reliable ground protection. Disconnect power before removing or placing the blending cup on the base.
16. Do not touch power cord or the appliance with wet hands to avoid electric shock.
17. If the power cord/plug is damaged or malfunction on the appliance, it must be repaired by the manufacturer or the service agent.
18. Do not repair or modify the appliance to avoid danger.
19. When in operation, do not touch the appliance to avoid scald. Keep away from children.
20. Do not put the appliance in fridge or freezer to avoid damage to electronic components. Coloring of the cup and lid from making some fruit and vegetable drinks is considered normal.
21. Do not touch the sharp blades to avoid injuries.
22. Please control the ingredient in between 800ml - 1000ml when preparing hot drink to avoid overcooked or uncooked.
23. Do not open the lid during cooking process. Beware of the steam and spilled of hot water.
24. The appliance uses high-speed motor which is controlled by the intelligent power board, intermittent sound occurs when blending is a normal phenomenon.
25. Dry the spill detector and electrode before using to avoid malfunction and the warning alarm.
26. To avoid pausing or overflowing. Do not open the lid during cooking process as there is a built-in safety sensor.
27. Do not add seasonings during cooking process to avoid scorching.
28. Make sure the blending cup, lid and feeding cover are in correct position before connecting to power.
29. When connected to power, do not place hands or sharp materials into the blending cup to avoid injury or damaging the appliance.

2. Package Contents and Technical Specifications

2.1 Package Contents

Standard Accessories



PS810

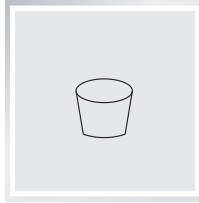

Measuring cup

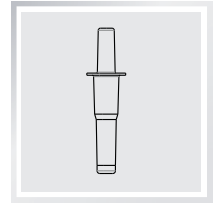

Stirring rod

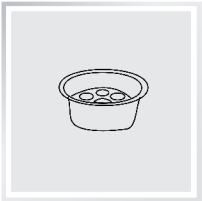

Steaming rack



Instruction Manual



Warranty

2.2 Technical Specifications

Product Name	Intelligent Food Processor
Model	PS810
Voltage	220-240V~50/60Hz
Motor loading power	800w
Heating power	800w
Volume	1750ml

* Package Contents and Technical and design specifications may be changed in the course of continuous product improvement.

2. Package Contents and Technical Specifications

2.3 Circuit Diagram

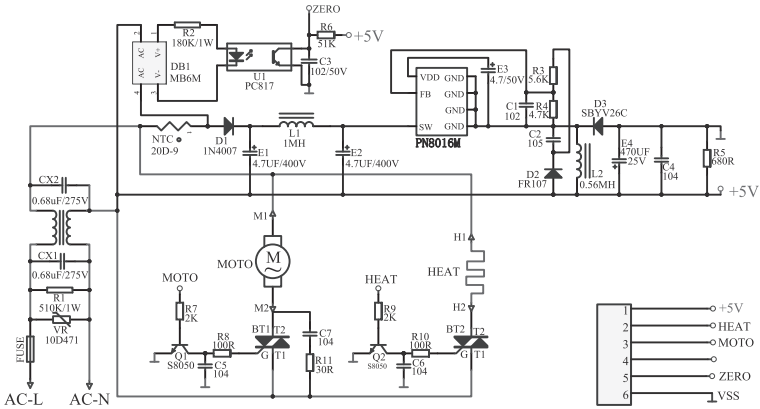

2.4 Product Diagram

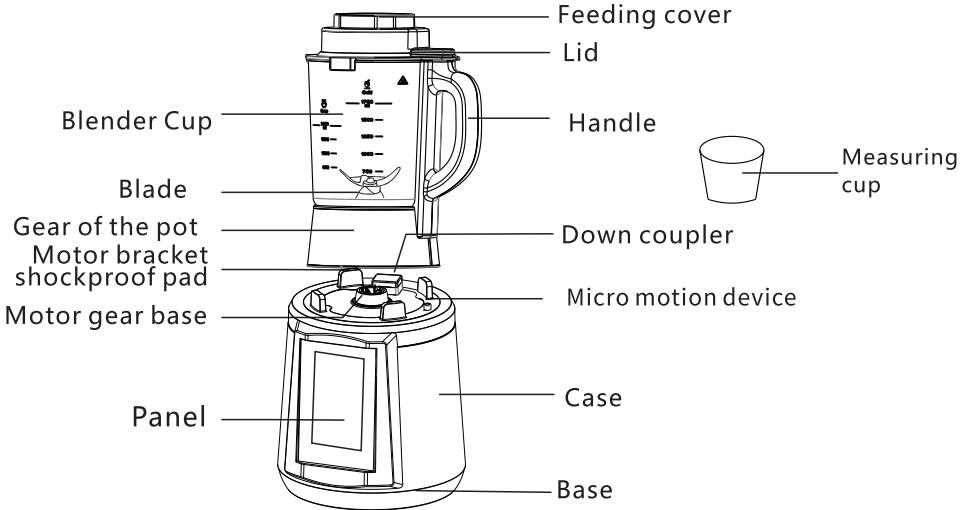

*The above pictures are for reference only, the specific product appearance and color refer to the actual product.

*Damages caused by the user's abuse and neglect in relation to the use of the blender cup will not be covered by the warranty. The Company shall not be responsible or liable for any repairs and maintenance for the blender cup.

2. Package Contents and Technical Specifications

2.5 Parts Description

1. Lid: made of food grade eco-materials, using with the blender cup to avoid spillage of the food.
2. Blender Cup: made from high quality borosilicate glass material; with stainless steel heating plate at the bottom for cooking the food.
3. Motor bracket shockproof pad: silicone pads for stabilizing the blender cup.
4. Gear motor base: power transmission unit.
5. Touch screen control panel: for choosing the desired function.
6. Feeding cover: block the hot steam to prevent burns.
7. Handle: used for moving the blender cup.
8. Blade: made of stainless steel, used for cutting and crushing food.
9. Lower clutch: supply working power; never place it under running water.
10. Upper clutch: must be align with the lower clutch in order to work properly.
11. Micro device on the base: work together with the corresponding micro device on the cup; do not press with hand or sharp hard objects when the power is on.
12. Base: support the machine with shockproof feet at the bottom.
13. Measuring cup: used for measuring the food portions.

3. Operating

3.1 Operation and Use

1. Prepare food ingredients in the recipe and put them into the blender cup

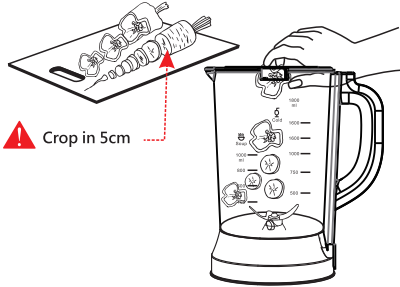

2. Add water not over the maximum level marking

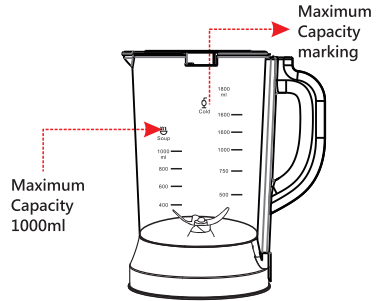

3. Tighten the feeding cover anti-clockwise on the lid

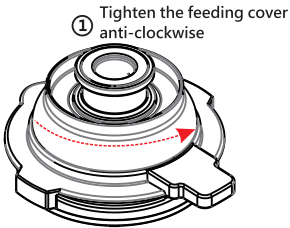

4. Tighten the lid clockwise on the blender cup

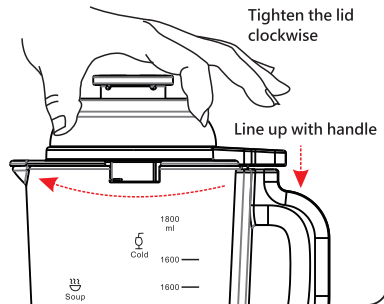

5. Place the blender cup on top of the motor base.

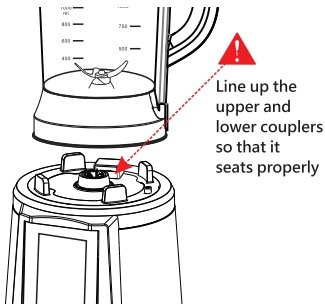

6. Connect to power supply

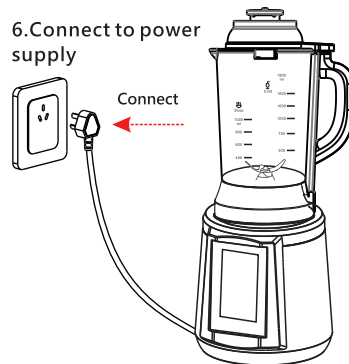

3. Operating

3.1 Operation and Use

7. Touch the "POWER" button to go to standby mode

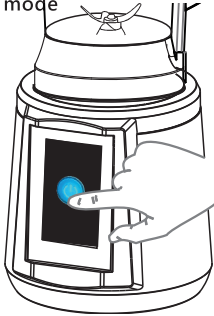

8. Go to the program menu and choose the desired program



9. After the program is finished, remove the feeding cover and add seasoning

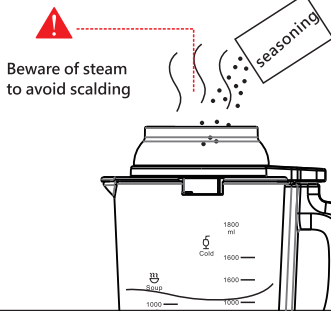

10. Press and hold the stir button for a few seconds



11. After done, disconnect the power supply and carefully remove the blender cup from the motor base

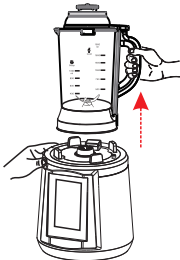

12. Pour it into cup to serve

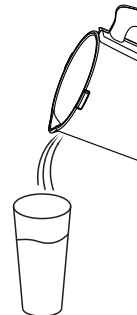

3. Operating

3.2 Control Panel

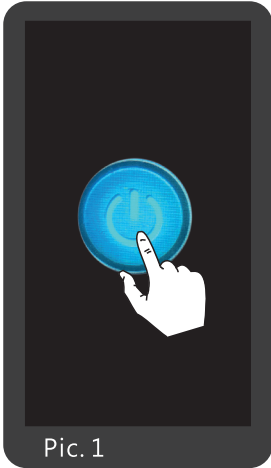

- ▶ **Power on:** After connecting to the electricity supply, the "POWER" button lights on. Touch the "POWER" button to activate the main control interface which is accompanied with a 2-second reminder tone. The machine will then be on standby mode (Pic. 1)
- ▶ **Power off:** Under standby mode and no function is selected, touch the "POWER off" button on the main control interface to turn off. Disconnect the power after the screen turns off.
- ▶ **Go to the program menu:** Touch the "more functions" button on the main control interface to go to the program menu (Pic. 2)
- ▶ **Return to the previous program menu:** Touch the "back" button to return to the previous program menu
- ▶ **Open the program:** Touch the program button to open the desired program (Pic. 3)

3. Operating

3.3 Activate Program



- ▶ Activate the program: After opening the program, the screen will show the food ingredients portions. User can follow the instructions to prepare the ingredient portions and then touch the activate button to start the cooking process (Pic. 4)
- ▶ Cancel the program: If the program needs to be stopped, touch the “cancel” button to stop the program (Pic. 5)
- ▶ Leave the program menu: The screen will show the reminder dialog box “this program is running and confirm leaving” . Touch the confirm button to return to the main control interface (Pic. 6)
- ▶ Keep Warm: After finishing the cooking, the program will go to keep warm page. The display will show the 30 minutes keep warm time and count down automatically. The display will return to the program menu after the count down. (Pic. 7)
- ▶ Cancel the keep warm: If keep warm needs to be stopped, touch the “cancel” button to stop keep warm and go back to the program menu.

3. Operating

3.4 Scheduling

- ▶ Scheduling: Touch the “preset” button in the program menu to enter the preset control panel. The timer uses a 24 hour display and the user can set the time as needed. Press “Λ” will increase hour/minute by 1, vice versa. After setting the time, press the “confirm” button and count down will start. The program will be executed when countdown finished.



3. Operating

3.4 Scheduling



Pic. 9

Scheduling function counts down in minutes.
(Note: preset time does not include the program execution time)

Some food ingredients could decay if immersed in water for too long. So it is not recommended to use scheduling function for time too long.

Recipes using the following food ingredients are not recommended to use scheduling function: milk, fish, dried shrimp, chicken meat, pork ribs, pork meat, beef etc.

4. Cleaning and Maintenance

4.1 Instructions for cleaning and maintenance

- Clean the blender cup and other accessories after use
- Switch off and unplug the machine before cleaning.
- Clean the motor unit and blender cup separately.

4.2 Cleaning and maintenance of motor unit

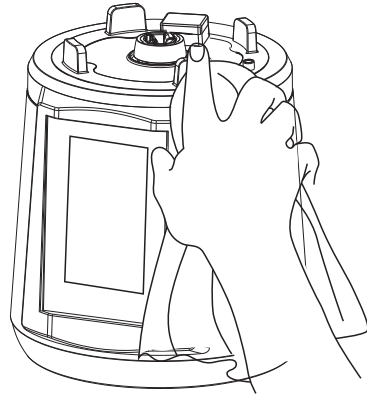
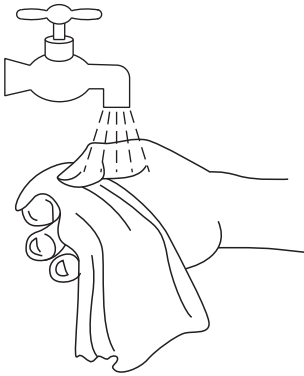

- Wipe the motor unit with cloth soaked in mild detergent and then clean with a dry cloth

Demonstrations

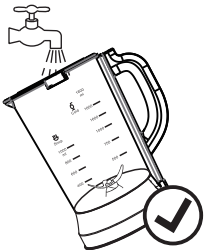

correct

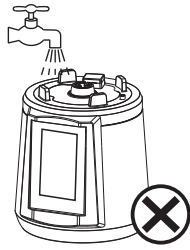

incorrect

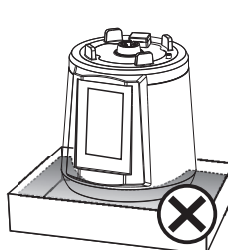

incorrect

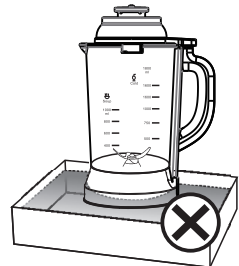

incorrect

4. Cleaning and Maintenance

4.3 Cleaning and maintenance of blender cup

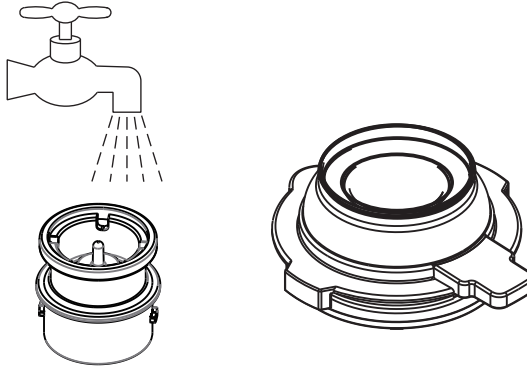

- Lid and feeding cover can be washed under running water and immersed in water.
- Wipe it with a dry cloth after cleaning with water and place it in dry cool place.
- Never touch the sharp blades with your fingers

CAUTION
for the sharp
blades



- Clean the blender cup and lid with sponge and brush or a dry cloth and then place them in dry cool place
 - If there are food residue got stuck at the bottom and hard to be removed, soak with warm water and then scrub with a brush and wash again with water thoroughly
- Cleaning tip and technique



Technique of blender cup cleaning

Put adequate amount of water into the blender cup and then press and hold the stir button to clean the cup automatically.

5. Troubleshooting

Please use this chart to troubleshoot common problems using PS810 Intelligent Food Processor.

Fault	Possible Causes	Solution
Indicator light does not come on	Indicator light failure	Check and make sure the appliance is connected with power supply
	Blender cup is not assembled on the motor unit properly	Assemble the cup and motor unit properly
	Blender cup or lid is not in the right place	Remove and reposition the blender cup and lid in the right place
The appliance is not working	Voltage too low	Check if the voltage is too low
	Used for a long time continuously and the motor unit is protected from overheating	Allow the motor unit to cool down at room temp for approx. 30 minutes Follow the user instruction on operating time
	The food processor is overloaded	Reduce the amount of food, follow the user instruction on maximum amount of food allowed
Food ingredients are not crushed properly	Too much or too few food ingredients added	Follow the recipe instructions on ingredient portions
	Incorrect program selection	
Overflow or scorched bottom	Too much food ingredients	Follow the recipe instructions on ingredient portions
	Blender cup is not cleaned thoroughly	Clean the blender cup thoroughly before using it again
Unpleasant odor	Odor is considered normal during initial use of the product when the motor unit is warming up	The odor will gradually disappear after several uses of the product. It is recommended to place the product at well-ventilated area to allow the odor to be adequately dispersed
Abnormal noise generated in operation	Blender cup or lid is not assembled correctly	Switch off the machine and remove the blender cup, Examine if any foreign object inside and re-assemble the blender cup and lid again
Heating but not stirring	Circuit board malfunction	Repair service



總代理 Sole Agent :

昇鋒國際有限公司 Pro Logic International Limited

香港九龍紅磡鶴園東街4號恆藝珠寶大廈1樓106-107室

Unit 106-107, 1/F, Heng Nagai Jewelry Centre, 4 Hok Yuen Street East,
Hung Hom, Kowloon, HK

Tel.: (852) 2365 0655



www.primada.com.hk

分銷商 Distributor :



愛家名品有限公司 iPlusHome Limited

www.iplushome.hk

