



Vegetable Over Spray Watering  
Vegetable Drip Watering  
Container Watering  
Hobby Greenhouse Watering

# Your Kitchen Garden Watering Solutions

- **Innovation:**  
Advanced water saving technology
- **Simplicity:**  
Designed for easy use by all hobby gardeners
- **All in One:**  
Each product is a complete watering system
- **Modification:**  
Watering solutions for every growing style

**ELGO**<sup>™</sup>  
SAVING WATER SINCE 1906  
[www.elgo-irrigation.com](http://www.elgo-irrigation.com)



# Basic Kits

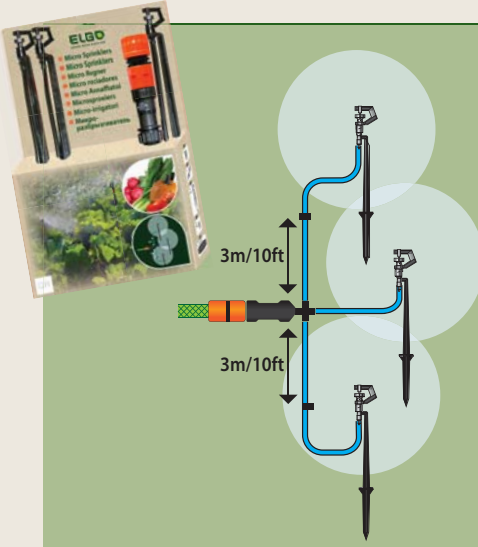

## MS3

### Micro Sprinklers for over spray watering

- Connect directly to the garden hose
- 2 minutes to place on ground
- No tools required
- Gentle spray watering
- Option for half circle nozzles
- Covers up to 50 m<sup>2</sup> / 540 ft<sup>2</sup>

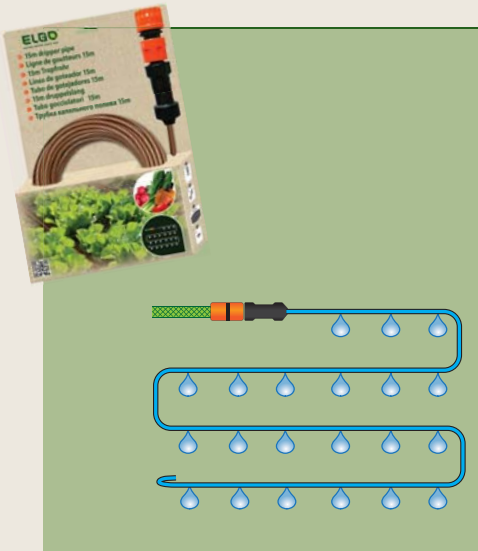
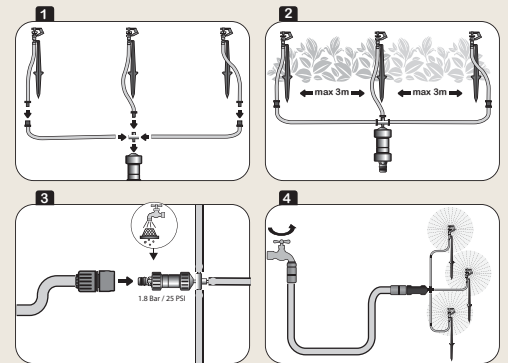

## DP15

### Dripper Pipe for accurate watering of vegetable rows

- Roll on card
- More precise than porous pipe
- Nicer look on ground
- Including pressure regulator and filter
- Length 15m/50ft, dripper spacing 0.3m/1ft
- Can be used for watering from water tank (minimum outlet height of 35cm/1.15 ft)

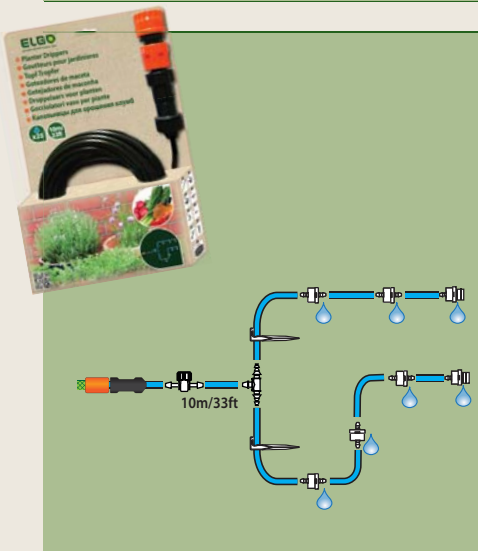
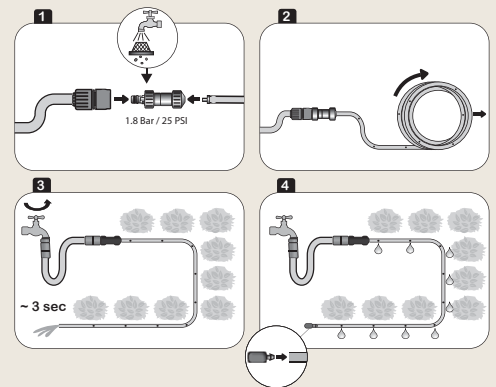

## PD25

### Planter Drippers for balcony and hobby greenhouse plants

- Simply cut and push drippers along the hose.
- Precise watering for planters and pots

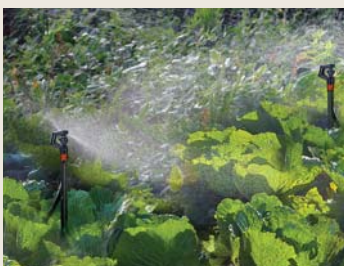
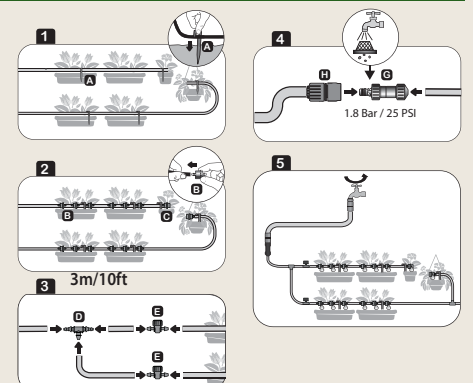
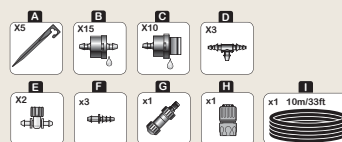



# Grower Line - Over Spray Watering

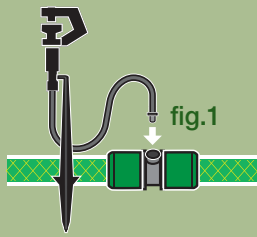

## SP20

### QuickUp - Portable Spray Watering System

#### Advantages

##### Complete watering system in one product

- Simple plug-and-play concept, no design skills required, mistake-free
- Allows you to cultivate vegetable rows freely
- Lawn watering without turf disturbance
- Takes only a few minutes to install or move between different vegetable or lawn areas
- Can be stored between usages
- Can be operated automatically during vacations

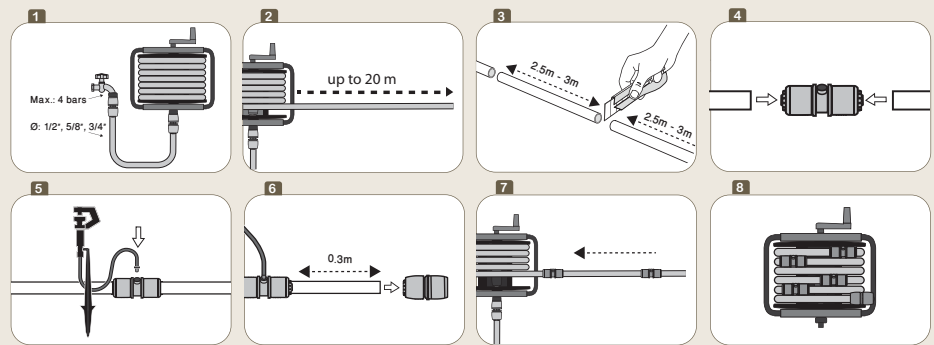
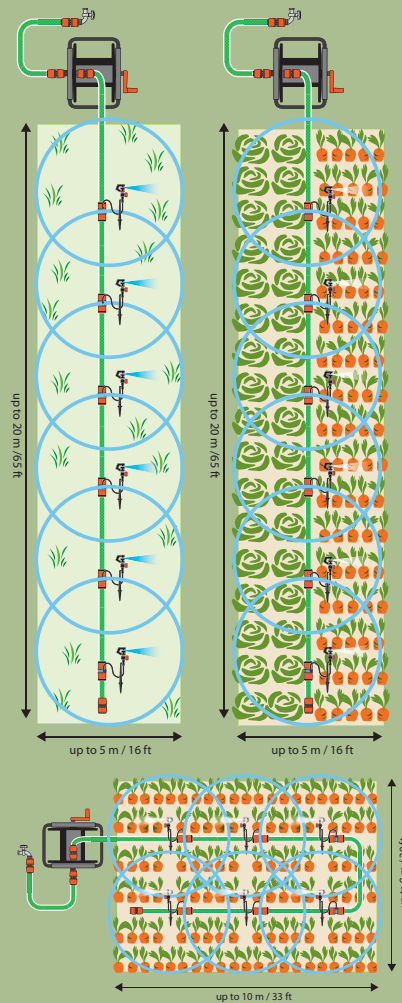

#### Specifications

- Uses innovative Quick-Up garden hose connector (fig.1), which can be rolled up with the hose on any hose reel
- Enables to connect and disconnect the micro sprinkler and seconds by simple push or pull action at the Quick-Up outlet
- Efficient water saving and gentle watering by micro sprinklers
- Option to fit variety of garden and lawn shapes with additional nozzles for different watering arc



|   |                             |                         |                         |
|---|-----------------------------|-------------------------|-------------------------|
| 100m <sup>2</sup><br>1000ft <sup>2</sup><br>max | 1<br>1/2"-5/8"<br>12.5-15mm | 900l/h<br>240gph<br>max | 4 bars<br>60 psi<br>max |
|---|-----------------------------|-------------------------|-------------------------|

#### Product Content

- 6 x Quick-Up connectors
- 1 x Line End connector
- 6 x Micro sprinklers, 360° on spike
- 6 x Flow control valves
- 6 x 180° replacement nozzles
- 4 x 90° replacement nozzles





# Grower Line - Drip Watering

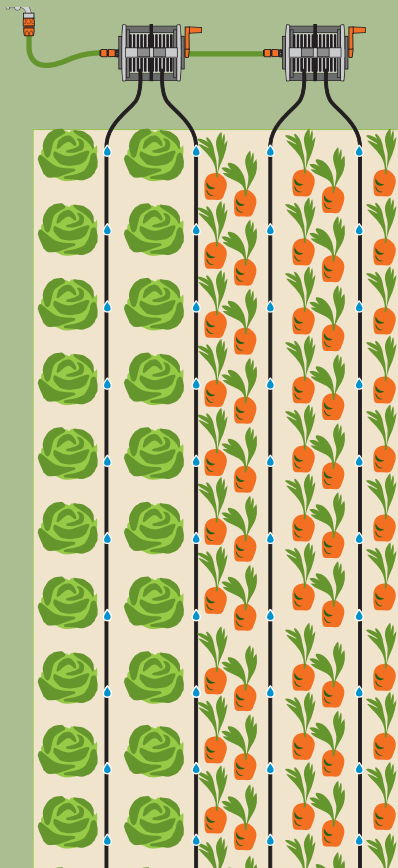

## DNR

### Drip'N Roll - Portable Drip Watering System

#### Advantages

##### Complete watering system in one product

- Simple plug-and-play concept, no design skills required, mistake-free
- Takes only a few minutes to install and to move between different garden areas
- Can be stored between usages
- Can be operated automatically during vacations

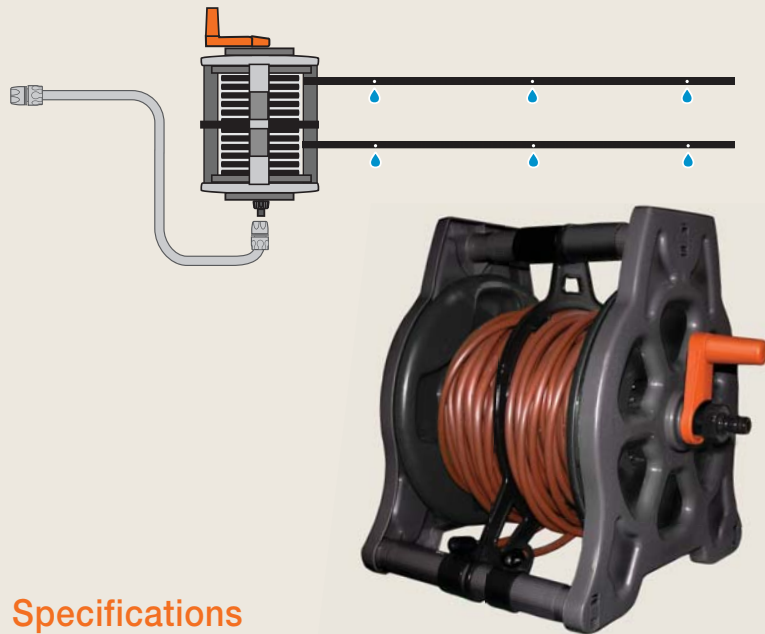

#### Specifications

- Uses water saving drip-lines pre-rolled on a multi-compartment roller
- Ready-to-use system, pre-assembled
- Efficient watering also in low pressure (rain water tanks)
- Connect multiple systems to each other to cover large areas



#### Product Content

- 1x Dual section hose reel
- 2 x 15m/60ft Drip lines 8mm, spacing of 0.3 / 12" between drippers
- 1 x 3/4" Pressure regulator 1.8bar/25psi
- 2 x 8mm repair joiner
- 4 x Metal spikes





# Grower Line - Hobby Greenhouse Watering

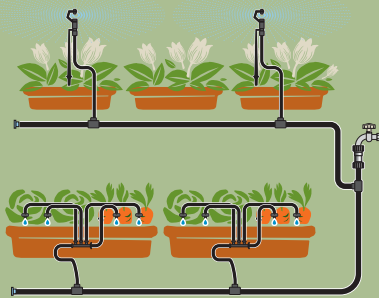

## EMGS

### Greenhouse Watering System

#### Advantages

#### 2 Watering systems in one kit

- 48 drippers for containers and pots
- 4 misting sprinklers for humidifying
- Assembly in minutes
- No tools required

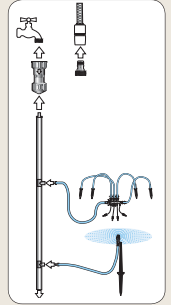

#### Product Content

- 1 x Pressure regulator
- 2 x Garden hose connector
- 5 x Cross connector
- 4 x End plug
- 1 x 3.6m/12ft supply pipe
- 4 x Micro sprinklers, 360° on spike
- 12 x Dripper sets (4 drippers each)



Elgo presents an inventive new Kitchen Garden watering kits range especially designed for hobby gardeners. This range provides the solution that many customers in Europe are looking for.

Simple, easy to install systems, enabling you to grow your own vegetable and fruit garden with exciting benefits:

1. Water saving
2. High yield from even a small garden
3. Saving money by growing your own food



Elgo's Kitchen Garden watering kits integrate the most advanced micro irrigation components in the industry, using the highest quality materials by leading producers.

All Elgo's products come assembled, enabling each hobby gardener, regardless of physical strength, to assemble and use the Kitchen Garden Watering Kits in a few minutes, without any effort.

#### Elgo Irrigation Ltd.

4 Shoham St., P.O.B 3147 Business Industrial Park Caesarea 38900, Israel  
 Tel: +972 4 9111444 Fax: +972 4 6231167 www.elgo.co.il / www.elgo-irrigation.com