



*Omer Ltd.*



---

# Home & Gardening Products

# Garden Trolley

- Multi-functional
- Strong
- Lightweight
- Weather resistant
- Garden tool holder
- Easy to assemble
- UV Protected
- Assembled size:  
60x50x87 cm  
23.6x19.7x34.2 inch

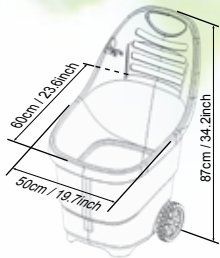

Item No.	Description	Price per Unit	Product Dim cm/inch			Weight per Unit Kg/Lbs	Qty Per Master	Packaging Details Master cm/inch			Master Pack Weight Kg/Lbs	Pallet Dim cm/inch	Qty per pallet	Container load		
			L	W	H			L	W	H				20"	40"	40"HC
GT008	Garden trolley 40" HC load-Poly bag		60.0 / 23.6	50.0 / 19.7	87.0 / 34.2	2.5 / 5.5	9	50.0 / 19.7	60.0 / 23.6	119.0/46.9	22.5 / 49.6	100x120 / 39x47.2	144	—	—	3,168
GT008	Garden trolley 20"/40" load-Poly bag		60.0 / 23.6	50.0 / 19.7	87.0 / 34.2	2.5 / 5.5	8	50.0 / 19.7	60.0 / 23.6	115.0/57.8	20 / 44	100x120 / 39x47.2	128	1,280	2,816	—
GT008	Garden trolley 40" HC load - Box		60.0 / 23.6	50.0 / 19.7	87.0 / 34.2	2.5 / 5.5	9	50.0 / 19.7	60.0 / 23.6	120.0/47.2	23 / 55	100x120 / 39x47.2	54/72	540		1,512

# Roll N' Kneel - 4 in 1

Roll, Kneel, Seat, Garden stool with storage compartment & removable cover for dual purpose

- Multi-functional
- Strong wheels
- Lightweight
- Storage compartment
- Weather resistant
- Easy to clean
- Max Weight: 100kg /220lb
- Foam pad for comfort kneeling
- UV Protected

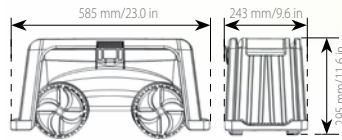

Item No.	Description	Price per Unit	Product Dim cm/inch			Weight per Unit Kg/Lbs	Qty Per Master	Packaging Details Master cm/inch			Master Pack Weight Kg/Lbs	Pallet Dim cm/inch	Qty per pallet 20"	Qty per pallet 40HC"	20' Container load	40HC' Container load
			L	W	H			L	W	H						
SNK005	Roll N' Kneel 4 in 1		58.5 / 23.2	24.3 / 9.6	29.5 / 11.6	2.0 / 4.4	4	50.0 / 19.7	60.0 / 23.6	59 / 23.2	8.0 / 17.6	100x120 / 39x47.2	48	64	480	1,408

# Roll N' Kneel - 3 in 1

Roll, Kneel, Seat, Garden stool with storage compartment & removable cover for dual purpose

- Multi-functional
- Strong wheels
- Lightweight
- Storage compartment
- Weather resistant
- Easy to clean
- Max Weight: 100kg /220lb
- Foam pad for comfort kneeling
- UV Protected

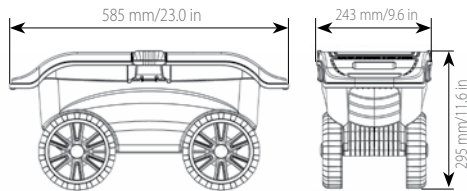

Item No.	Description	Price per Unit	Product Dim cm/inch			Weight per Unit Kg/Lbs	Qty Per Master	Packaging Details Master cm/inch			Master Pack Weight Kg/Lbs	Pallet Dim cm/inch	Qty per pallet 20"	Qty per pallet 40HC"	20' Container load	40HC' Container load
			L	W	H			L	W	H						
SNK003	Roll N' Kneel 3 in 1		58.5 / 23.0	24.3 / 9.6	29.5 / 11.6	1.7 / 3.7	4	50.0 / 19.7	60.0 / 23.6	59 / 23.2	6.8 / 14.8	100x120 / 39x47.2	48	64	480	1,408

# Fishing Roll & Storage Chair

Roll & Seat with storage compartment for Fishing accessories.

- Multi-functional Rolling storage/Seating
- Strong wheels
- Lightweight
- Storage compartment for fishing accessories
- Weather resistant
- UV Protected

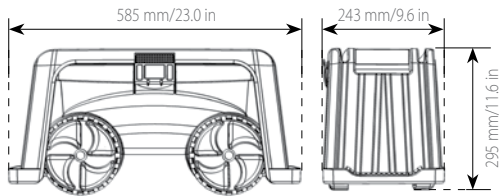

Item No.	Description	Price per Unit	Product Dim cm/inch			Weight per Unit Kg/Lbs	Qty Per Master	Packaging Details Master cm/inch			Master Pack Weight Kg/Lbs	Pallet Dim cm/inch	Qty per pallet 20"	Qty per pallet 40HC"	20' Container load	40HC' Container load
			L	W	H			L	W	H						
SNK005	Roll N' Kneel 4 in 1		58.5 / 23.2	24.3 / 9.6	29.5 / 11.6	2.0 / 4.4	4	50.0 / 19.7	60.0 / 23.6	59 / 23.2	8.0 / 17.6	100x120 / 39x47.2	48	64	480	1,408

# 2x70 Liter / 2x18.5 Gallon Dual Chamber Tumbling Composter

- Metal legs
- Dual compartments for more efficient use of home and garden waste
- Easy to assemble
- Aeration system to speed up composting process.
- Heavy Duty all-season construction for year-round composting
- Easy to slide doors
- Mixing bars are included
- 2 Stoppers for comfortable use
- 2x70 Liter /18.5 Gallon / 2.47 cubic feet
- UV Protected
- Product dimensions: 63x60x74 cm  
24.8x23.6x29.1 inch



®  
Reg.  
Design



Mixing bars



Stopper

Item No.	Description	Price per Unit	Product Dim cm/inch			Weight per Unit Kg/Lbs	Qty Per Master	Packaging Details Master cm/inch			Master Pack Weight Kg/Lbs	Pallet Dim cm/inch	Qty per pallet 20"	Qty per pallet 40HC"	20' Container load	40HC' Container load
			L	W	H			L	W	H						
DC140	Composter 2 Cells 70L		63.0 / 24.8	60.0 / 23.6	74.0 / 29.1	9.4/20.7	1	66.0 / 26.0	56.0/22.0	16.0 / 6.3	—	124x109 / 48.8x42.9	56	64	448	1,152

# 2x105 Liter / 2x28 Gallon Dual Chamber Tumbling Composter

- Metal legs
- Dual compartments for more efficient use of home and garden waste
- Easy to assemble
- Aeration system to speed up composting process
- Heavy Duty construction for year-round composting
- Easy to slide doors
- Mixing bars are included
- 2x105 Liter /28 Gallon / 3.7 cubic feet
- 2 Stoppers for comfortable use
- UV Protected
- Product dimensions: 88x60x74 cm  
34.6x23.6x29.1 inch

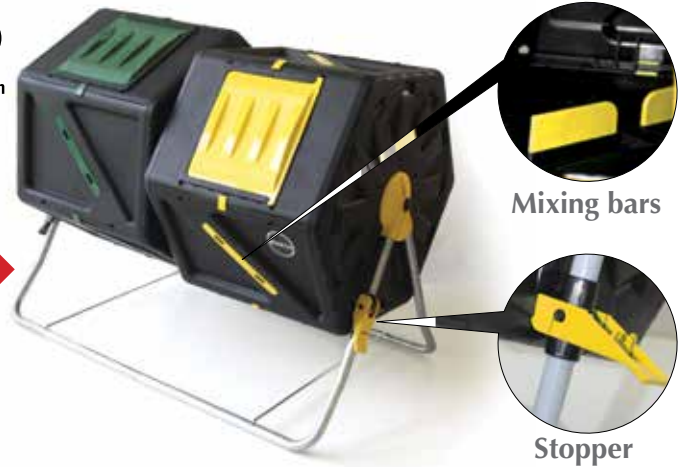

Item No.	Description	Price per Unit	Product Dim cm/inch			Weight per Unit Kg/Lbs	Qty Per Master	Packaging Details Master cm/inch			Master Pack Weight Kg/Lbs	Pallet Dim cm/inch	Qty per pallet 20"	Qty per pallet 40HC"	20' Container load	40HC' Container load
			L	W	H			L	W	H						
DC210	Composter 2 Cells 105L		88.0 / 34.6	60.0 / 23.6	74.0 / 29.1	11.0/24.2	1	66.0 / 26.0	56.0/22.0	16.0 / 6.3	—	124x109 / 48.8x42.9	56	64	448	1,152

# 70 Liter / 18.5 Gallon Tumbling Composter

- Metal legs
- Speeds up composting – saves effort in turning backyard waste into compost
- Easy to assemble
- Aeration system to speed up composting process.
- Heavy Duty all-season construction for year-round composting
- Easy to slide door
- Mixing bars are included
- 70 Liter /18.5 Gallon / 2.47 cubic feet
- Stopper for comfortable use
- UV Protected
- Product dimensions: 43x60x74 cm  
16.9x23.6x29.1 inchh



®  
Reg.  
Design

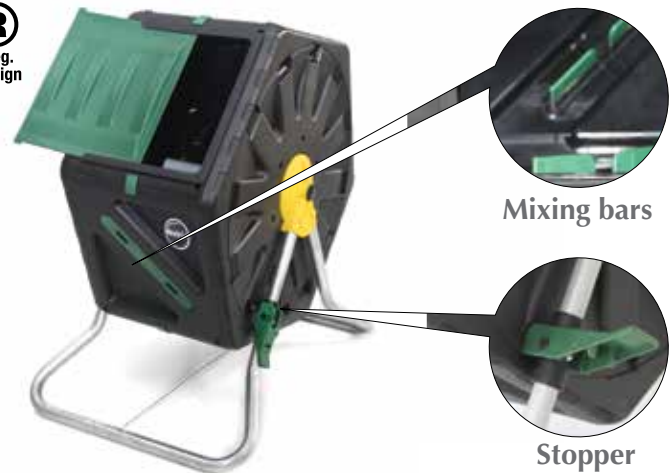

Item No.	Description	Price per Unit	Product Dim cm/inch			Weight per Unit Kg/Lbs	Qty Per Master	Packaging Details Master cm/inch			Master Pack Weight Kg/Lbs	Pallet Dim cm/inch	Qty per pallet 20"	Qty per pallet 40HC"	20' Container load	40HC' Container load
			L	W	H			L	W	H						
SC70	Single Composter 70L		43.0 / 16.9	60.0 / 23.6	74.0 / 29.1	5.1/11.2	1	61.0 / 24.0	56.0 / 22.0	12.0 / 4.7	—	124x109 / 48.8x42.9	68	80	544	1,440



# 105 Liter / 28 Gallon Tumbling Composter

- Metal legs
- Speeds up composting – saves effort in turning backyard waste into compost
- Easy to assemble
- Aeration system to speed up composting process.
- Heavy Duty all-season construction for year-round composting
- Easy to slide door
- Mixing bars are included
- 105 Liter /28 Gallon / 3.7 cubic feet
- Stopper for comfortable use
- UV Protected
- Product dimensions: 58x60x74 cm  
22.8x23.6x29.1 inch



®  
Reg. Design

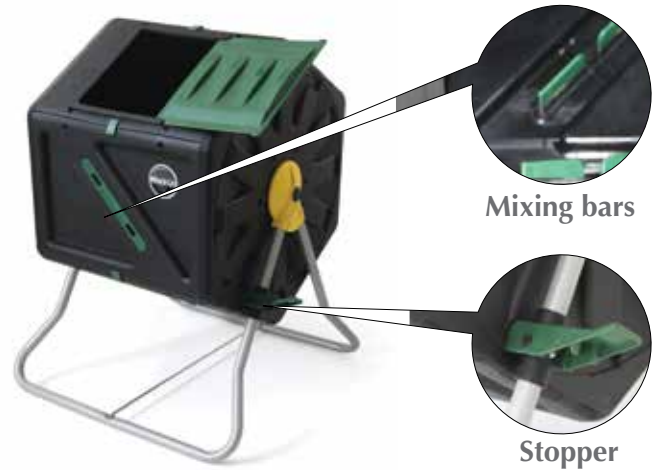

Item No.	Description	Price per Unit	Product Dim cm/inch			Weight per Unit Kg/Lbs	Qty Per Master	Packaging Details Master cm/inch			Master Pack Weight Kg/Lbs	Pallet Dim cm/inch	Qty per pallet 20"	Qty per pallet 40HC"	20' Container load	40HC' Container load
			L	W	H			L	W	H						
SC105	Single Composter 105L		43.0 / 16.9	60.0 / 23.6	74.0 / 29.1	5.6/12.3	1	61.0 / 24.0	56.0 / 22.0	12.0 / 4.7	—	124x109 / 48.8x42.9	68	80	544	1,440

# Trolley Tumbling Composter

70/105/2x70 Liter / 18.5/28/2x18.5 Gallon

- Metal legs
- Speeds up composting – saves effort in turning backyard waste into compost
- Easy to assemble
- Aeration system to speed up composting process.
- Heavy Duty all-season construction for year-round composting
- Easy to slide door
- Mixing bars are included
- 70/105/2x70Liter /18.5/28/2x18.5 Gallon
- Stopper for comfortable use
- UV Protected

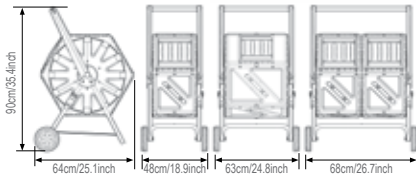

Item No.	Description	Price per Unit	Product Dim cm/inch			Weight per Unit Kg/Lbs	Qty Per Master	Packaging Details Master cm/inch			Master Pack Weight Kg/Lbs	Pallet Dim cm/inch	Qty per pallet 20"	Qty per pallet 40HC"	20' Container load	40HC' Container load
			L	W	H			L	W	H						
TC70	Trolley Composter 70L		48.0 / 18.9	63.0 / 24.8	90.0 / 35.4	5.8/12.8	1	61.0 / 24.0	56.0 / 22.0	12.0 / 4.7	—	124x109 / 48.8x42.9	68	80	544	1,440
TC105	Trolley Composter 105L		63.0 / 24.8	63.0 / 24.8	90.0 / 35.4	6.3/13.9	1	61.0 / 24.0	56.0 / 22.0	12.0 / 4.7	—	124x109 / 48.8x42.9	68	80	544	1,440
TC2X70	Trolley Composter 2X70L		64.0 / 25.1	63.0 / 24.8	90.0 / 35.4	10.2/22.5	1	66.0 / 26.0	56.0/22.0	16.0 / 6.3	—	124x109 / 48.8x42.9	56	64	448	1,152

# 180 Liter / 47.5 Gallon Tumbling Composter

- Plastic legs
- Speeds up composting – saves effort in turning backyard waste into compost
- Internal aeration accelerates process to make compost in 3-4 weeks
- 180 Liter /47.5 Gallon / 6.5 cubic feet
- 2 Positions stopper for comfortable use
- UV Protected
- Product dimensions: 76(w) x 104(d) x 107cm(h)  
30.5”(w) x 41”(d) x42.5”(h)



Compost is nature's way of recycling and the benefits of compost are many

- Composting reduces the amount of organic waste that goes into trash collection and land fills
- Compost contains a full range of essential plant nutrients and decrease need for fertilizers
- Compost alters soilcomposting, making it less likely to erode and easier to work with



Item No.	Description	Price per Unit	Product Dim cm/inch			Weight per Unit Kg/Lbs	Qty Per Master	Packaging Details Master cm/inch			Master Pack Weight Kg/Lbs	Pallet Dim cm/inch	Qty per pallet 20"	Qty per pallet 40HC"	20' Container load	40HC' Container load
			L	W	H			L	W	H						
C1180	Tumbling Composter		76.0 / 29.9	79.0 / 31.1	45.0 / 17.7	8.0 / 17.6	12	82.0 / 32.3	76.0 / 29.9	117.0 / 46.0	96.7 / 212.7	76x78 / 29.9x30.1	—	12	—	1,056
C1180	Tumbling Composter		76.0 / 29.9	79.0 / 31.1	45.0 / 17.7	8.0 / 17.6	10	82.0 / 32.3	76.0 / 29.9	110.0 / 43.3	80.7 / 177.5	76x78 / 29.9x30.1	10	—	420	—
C1180	Tumbling Composter		76.0 / 29.9	79.0 / 31.1	45.0 / 17.7	8.0 / 17.6	6	82.0 / 32.3	76.0 / 29.9	73.0 / 28.7	48.5 / 106.8	76x78 / 29.9x30.1	—	6	—	792

# 50L /13.2 Gallon Tumbling Composter

## Single / Dual Chamber

- Single/Dual compartments for more efficient use of home and garden waste
- Aeration system to speed up composting process
- Heavy Duty all-season construction for year-round composting
- Easy to assemble
- Built-in mixers
- Large door
- Steady base with Liquid compost drawer
- 2x50 Liter /13.2 Gallon / 1.76 cubic feet
- UV Protected
- Product dimensions:

Single: 49.5x44.5x57.0cm/19.5x17.5x22.4inch

Dual: 49.5x89.0x57.0cm/19.5x35.0x22.4inch

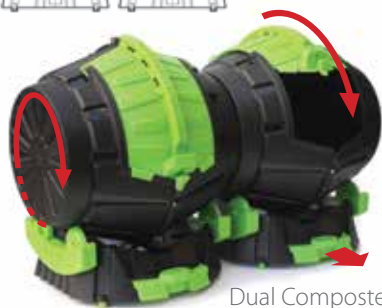
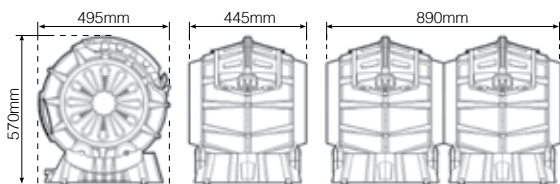

Dual Composter



Single Composter



Liquid compost drawer



Item No.	Description	Price per Unit	Product Dim cm/inch			Weight per Unit Kg/Lbs	Qty Per Master	Packaging Details Master cm/inch			Master Pack Weight Kg/Lbs	Pallet Dim cm/inch	Qty per pallet 20"	Qty per pallet 40HC"	20' Container load	40HC' Container load
			L	W	H			L	W	H						
DC50	Composter 2 Cells 50L		49.5 / 19.5	89.0 / 35.0	57.0 / 22.4	6.2/13.6	1	49.0 / 19.3	49.0 / 19.3	30.0 / 11.8	7.6/16.8	100x100 / 39.4x39.4	32	40	320	880
C50	Composter 50L		49.5 / 19.5	44.5 / 17.5	57.0 / 22.4	3.1/6.8	1	49.0 / 19.3	49.0 / 19.3	24.0 / 9.4	3.9/8.6	120x100 / 47.2x39.4	36	50	360	1,100

# Garden Kneeler

- Multi-functional
- Strong
- Lightweight
- Storage compartment
- Weather resistant
- Easy to clean
- Max Weight: 100kg /220lb
- UV Protected
- Foam pad for comfort kneeling
- Size: 58(w) x 22.5(d) x 38cm(h)  
22.8"(w) x 8.8"(d) x 15"(h)



Item No.	Description	Price per Unit	Product Dim cm/inch			Weight per Unit Kg/Lbs	Qty Per Master	Packaging Details Master cm/inch			Master Pack Weight Kg/Lbs	Pallet Dim cm/inch	Qty per pallet 20"	Qty per pallet 40HC"	20' Container load	40HC' Container load
			L	W	H			L	W	H						
GK25	Garden Kneeler		58.0 / 22.8	22.5 / 8.8	38.0 / 15.0	1.175 / 2.59	12	23 / 9.0	60.0 / 23.6	123.0 / 48.4	14.1 / 31.0	116x118 / 45.6x46.4	240	240	2,400	4,800
GK25	Garden Kneeler		58.0 / 22.8	22.5 / 8.8	38.0 / 15.0	1.175 / 2.59	6	23 / 9.0	60.0 / 23.6	78.0 / 30	7.0 / 15.5	116x118 / 45.6x46.4	240	240	2,400	4,800
GK25	Garden Kneeler		58.0 / 22.8	22.5 / 8.8	38.0 / 15.0	1.175 / 2.59	6	23 / 9.0	60.0 / 23.6	78.0 / 30	7.0 / 15.5	No Pallate				6,200
GK25	Garden Kneeler		58.0 / 22.8	22.5 / 8.8	38.0 / 15.0	1.175 / 2.59	6	23 / 9.0	60.0 / 23.6	78.0 / 30	7.0 / 15.5	80x120 / 31.5x47.2	120	132	1,320	3,300

# Seat N' Kneel - 2 in 1

- Multi-functional Seat & Kneel
- Strong
- Lightweight
- Easy to carry and use
- Weather resistant
- Easy to clean
- Max Weight: 100kg /220lb
- Foam pad for comfort kneeling
- UV Protected

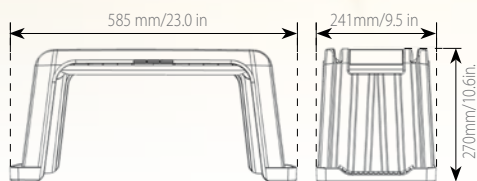

Reg. Design



Item No.	Description	Price per Unit	Product Dim cm/inch			Weight per Unit Kg/Lbs	Qty Per Master	Packaging Details Master cm/inch			Master Pack Weight Kg/Lbs	Pallet Dim cm/inch	Qty per pallet 20"	Qty per pallet 40HC"	20' Container load	40HC' Container load
			L	W	H			L	W	H						
SNK002	Seat N' Kneel-2 in 1		58.5 / 23.0	24.1 / 9.5	27.0 / 10.6	0.75 / 1.65	6	58.9 / 23.2	24.1 / 9.5	47.0 / 18.5	4.5 / 9.92	100x120 / 39x47.2	336	432	3,360	9,504

# Easy Kneel

- Strong
- Lightweight
- Easy to carry and use
- Weather resistant
- Easy to clean
- Foam pad for comfort kneeling
- UV Protected

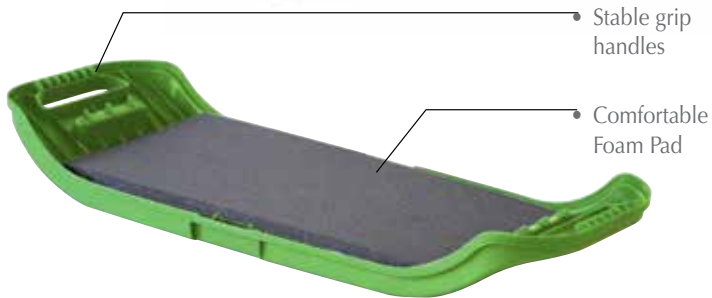
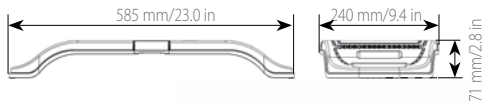

Item No.	Description	Price per Unit	Product Dim cm/inch			Weight per Unit Kg/Lbs	Qty Per Master	Packaging Details Master cm/inch			Master Pack Weight Kg/Lbs	Pallet Dim cm/inch	Qty per pallet 20"	Qty per pallet 40HC"	20' Container load	40HC' Container load
			L	W	H			L	W	H						
SNK001	Easy Kneel		58.5/23.0	24.0/9.4	7.1/2.8	0.56/1.2	10	58.5/23.0	25.5/10.0	26.0/10.2	5.6/12.3	100x120/39x47.2	270	320	2,700	7,040

# Raised Garden Bed

## 4 Panel Raised Garden Bed

- Panel dimensions: 60x20x3 cm / 23.6x7.9x1.2 in
- RGB Assemble dimensions: 120x120x20cm / 47.2x47.2x7.9 in
- Volume: Holds 260 L / 68.7 Gallons / 9.2 cubic feet
- Colors: Brown / Green
- Customize your garden shape
- Create larger gardens by using multiple kits
- Easy to setup
- Rigid resin construction
- Easy to use connectors keeps panels securely in place
- Includes 4 panels
- UV Protected

Panel include Connector system allows you to create a wide range of shapes to designs that best suit your space by purchasing additional Raised Garden Bed kits.



60x60



120x60



120x120

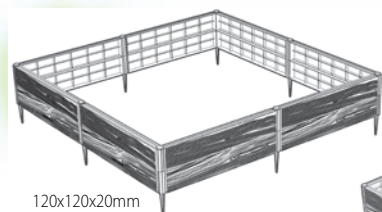

120x120x20mm

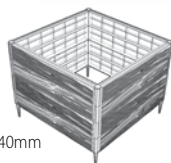

60x60x40mm

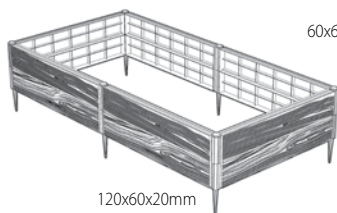

120x60x20mm

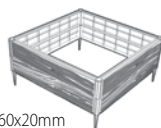

60x60x20mm

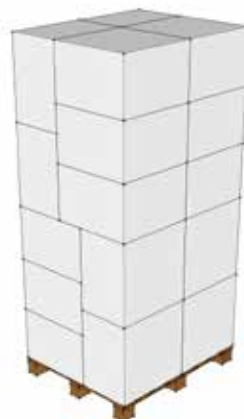

Item No.	Description	Price per Unit	Product Dim			Weight per Unit	Qty Per Master	Packaging Details Master			Master Pack Weight	Pallet Dim	Qty per pallet	Qty per pallet	20' Container load	40HC' Container load
			L	W	H			L	W	H						
RGB 120	Raised Garden Bed 120x120		60.0 / 23.6	40.0 / 15.8	12.0 / 4.7	3.50 / 7.7	5	60.0 / 23.6	60.0 / 23.6	40.0 / 15.8	17.5 / 38.6	100x120 / 39.4x47.2	80	100	800	2,200
RGB 60120	Raised Garden Bed 120x60		60.0 / 23.6	20.0 / 7.9	18.0 / 7.1	2.62 / 5.8	5	60.0 / 23.6	45.0 / 17.7	40.0 / 15.8	17.5 / 38.6	90x120 / 35.4x47.2	90	120	900	2,640
RGB 60	Raised Garden Bed 60x60		60.0 / 23.6	20.0 / 7.9	12.0 / 4.7	1.75 / 3.9	10	60.0 / 23.6	60.0 / 23.6	40.0 / 15.8	17.5 / 38.6	100x120 / 39.4x47.2	160	200	1,600	4,400



# Hose Hanger 001

- Protective door cover
- Ideal for keeping your hose tidy and manageable
- Easy to assemble
- Suitable for up to 150ft (45m) hose
- Storage space with shelf
- UV Protected

Product dimensions: 34.9(w) x 16(d) x 31.6cm(h)  
13.8"(w) x 6.3"(d) x 12.4"(h)

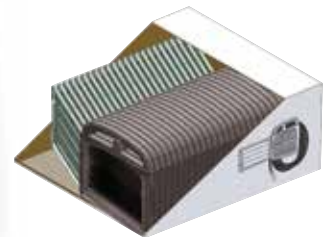

Item No.	Description	Price per Unit	Product Dim cm/inch			Weight per Unit Kg/Lbs	Qty Per Master	Packaging Details Master cm/inch			Master Pack Weight Kg/Lbs	Pallet Dim cm/inch	Qty per pallet 20"	Qty per pallet 40HC"	20' Container load	40HC' Container load
			L	W	H			L	W	H						
HRW001	Hose Hanger 001		34.9 / 13.8	16.0 / 6.3	31.6 / 12.4	0.63 / 1.38	22	57.0 / 22.4	32.5 / 12.8	71.0 / 27.9	13 / 28.6	100x120 / 39.4x47.2	396	440	3,960	9,240
HRW001	Hose Hanger 001		34.9 / 13.8	16.0 / 6.3	31.6 / 12.4	0.63 / 1.38	10	57.0 / 22.4	32.5 / 12.8	48.3 / 19.0	13 / 28.6	100x120 / 39.4x47.2	260	300	2,600	7,200



Home & Gardening Products

www.dfomer.com

# Hose Hanger 002

- Ideal for keeping your hose tidy and manageable
- Easy to assemble
- Suitable for up to 150ft (45m) hose
- Storage space
- UV Protected

Product dimensions:

27.6(w) x 14.6(d) x 27.8cm(h)

10.8"(w) x 5.7"(d) x10.9"(h)



Hose & Accessories are not included



Item No.	Description	Price per Unit	Product Dim cm/inch			Weight per Unit Kg/Lbs	Qty Per Master	Packaging Details Master cm/inch			Master Pack Weight Kg/Lbs	Pallet Dim cm/inch	Qty per pallet 20"	Qty per pallet 40HC"	20' Container load	40HC' Container load
			L	W	H			L	W	H						
HRW002	Hose Hanger 002		32.0 / 12.6	15.5 / 6.1	28.0 / 11.0	0.23 / 0.51	24	50.0 / 19.7	33.6 / 13.2	28.0 / 11.0	5.7 / 12.6	100x120 / 39.4x47.2	1152	1344	11,520	28,224
HRW002	Hose Hanger 002		32.0 / 12.6	15.5 / 6.1	28.0 / 11.0	0.23 / 0.51	10	33.0 / 13.0	28.0 / 11.0	41.0 / 16.1	2.4 / 5.3	100x120 / 39.4x47.2	600	600	6,000	13,200

# Hose Hanger 003

- Ideal for keeping your hose tidy and manageable
- Easy to assemble
- Suitable for up to 15m (50ft) hose
- Hanging hooks
- UV Protected

Product dimensions:

23.3(w) x 14(d) x 15cm(h)

9.2"(w) x 5.5"(d) x 5.9"(h)



Hose & Accessories are not included



Item No.	Description	Price per Unit	Product Dim cm/inch			Weight per Unit Kg/Lbs	Qty Per Master	Packaging Details Master cm/inch			Master Pack Weight Kg/Lbs	Pallet Dim cm/inch	Qty per pallet 20"	Qty per pallet 40HC"	20' Container load	40HC' Container load
			L	W	H			L	W	H						
HRW003	Hose Hanger 003		23.5 / 9.2	17.0 / 6.7	15.0 / 5.9	0.15 / 0.33	24	35.0 / 13.8	24.0 / 9.4	43.0 / 16.9	3.8 / 8.4	100x120 / 39.4x47.2	1,800	2,040	16,200	42,840
HRW003	Hose Hanger 003		23.5 / 9.2	17.0 / 6.7	15.0 / 5.9	0.15 / 0.33	12	42.5 / 16.7	24.0 / 9.4	18.0 / 7.1	1.8 / 4.0	100x120 / 39.4x47.2	1,632	2,040	16,320	42,840



Home & Gardening Products

www.dfomer.com

# Garden Leaf/Rubbish Collector

- Comfortable use
- Ergonomic handles
- Strong
- Lightweight
- Weather resistant
- Dual colors
- UV Protected



Item No.	Description	Price per Unit	Product Dim cm/inch			Weight per Unit Kg/Lbs	Qty Per Master	Packaging Details Master cm/inch			Master Pack Weight Kg/Lbs	Pallet Dim cm/inch	Qty per pallet 20"	Qty per pallet 40HC"	20' Container load	40HC' Container load
			L	W	H			L	W	H						
LC10	Garden Leaf collector		50.0 / 19.7	35.0 / 13.8	12.0 / 4.7	0.575 / 1.26	12	77.0 / 30.3	35.0 / 13.8	50.0 / 19.7	7.2 / 15.9	75x106 / 29.5x41.7	156	180	2,496	5,940
LC06	Garden Leaf collector		50.0 / 19.7	35.0 / 13.8	12.0 / 4.7	0.575 / 1.26	6	47.0 / 18.5	35.0 / 13.8	50.0 / 19.7	3.4 / 7.5	100x100 / 39.4x39.4	-	168	-	4,032

# Complete Solar Garden Tower with worm farm

6 tier's garden tower with 36 slots for vertical growing of many different plants such as:

- Fruits & Berries Gardens
- Herb/Spices Gardens
- Organic Gardens
- Tomato Gardens
- Flower Gardens
- Vegetable Gardens

- 6 tiers tower with 6 slots in each tier.
- Worm farm.
- Solar Self watering system.
- Easy to assemble.
- Easy to use and maintain.
- Environmental friendly.
- 30L Large watering tank.
- Compost pipe + lid.
- All watering systems are included.
- UV protected.
- Assembled sizes: 68cm/27"(Dia) x 132cm/52"(H).

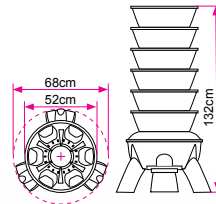

Item No.	Description	Price per Unit	Product Dim cm/inch			Weight per Unit Kg/Lbs	Qty Per Master	Packaging Details Master cm/inch			Master Pack Weight Kg/Lbs	Pallet Dim cm/inch	Qty per pallet 20"	Qty per pallet 40HC"	20' Container load	40HC' Container load
			L	W	H			L	W	H						
GT00	Garden Tower		55.0 / 21.6	55.0 / 23.6	33.0 / 13.0	13.4 / 29.5	1	55.0 / 21.6	55.0 / 21.6	33.0 / 13.0	13.4 / 29.5	100x120 / 39.4x47.2	—	32	—	640

# Window Bird Feeder

## See Birds Up Close!

- Extra clear XL Window Bird Feeder  
Let's watch the birds in the best way possible
- A removable feeding tray  
Enables easy grain fill-in
- Large drainage channels  
Allows good drainage of rainwater
- 4 Vacum nippels  
Strong snap to the window



A removable feeding tray



Large drainage channels



4 Vacum nippels



Item No.	Description	Price per Unit	Product Dim cm/inch			Weight per Unit Kg/Lbs	Qty Per Master	Packaging Details Master cm/inch			Master Pack Weight Kg/Lbs	Pallet Dim cm/inch	Qty per pallet 20"	Qty per pallet 40HC"	20' Container load	40HC' Container load
			L	W	H			L	W	H						
WBF	Window Bird Feeder		30.0 / 11.8	14.0 / 5.5	10.0 / 3.9	— / —	12	29 / 11.4	25 / 9.8	30 / 11.8	—	120x100 / 47.2x39.4	960	1152	9,600	25,344

## Company Profile

Established in 2005, D. F. Omer Ltd. has quickly established itself as one of the largest suppliers of home and garden products around the globe. With over 100 combined years of product development, production and international export expertise, the skilled leadership team at D. F. Omer Ltd. has the experience to meet the ever changing needs and challenges in the retail marketplace.

D. F. Omer Ltd. was recently awarded the Miracle-Gro license by Scotts for their lawn and garden division, winning out over 10 other major suppliers. Chosen for their commitment to quality, expansive category depth, and innovative product development, D. F. Omer Ltd. is proud to offer the Miracle-Gro brand name on many of their most popular items in North America.

The foundation to their success is the core principle that quality, design creativity, manufacturing proficiency and overall product excellence all starts at the beginning. The emphasis on these core building blocks allows D. F. Omer Ltd. to consistently produce goods that are of the highest value in the marketplace.

Their commitment to quality has enabled D. F. Omer Ltd. to be a certified ISO9001 manufacturer. They also routinely successfully pass all major international retailer factory audits and individual product testing standards. This overall emphasis on quality is backed up by an extensive in-house Quality Assurance department committed to every day quality excellence. The company is committed to the preservation of the planet and uses recycled product at all opportunities to reduce their own company carbon footprint.

D. F. Omer Ltd. prides itself on being flexible and responsive so in keeping with that commitment recently established D. F. Omer USA, Inc. with a fulfillment center in North Carolina to meet the needs of their ever expanding North America customer base. Quick bulk order turnarounds and same day e-commerce shipments are the warehouse standards.

Whether your retail needs are reliability, on-time complete shipments, new product innovation, product quality, a marquee brand name, or simply overall value, D. F. Omer Ltd. has made the choice an easy one by "checking all the boxes" for your search. A new D. F. Omer Ltd. customer quickly becomes a loyal, long term partner.



INDUSTRIAL ZONE ITZHAKI  
BUILDING 4  
Israel 3784000

Kibbutz Mishmarot, Israel

**Tel: 00972-4-8844038**

**Fax: 00972-4-8416377**

**E-mail: [hagai@dfomer.com](mailto:hagai@dfomer.com)**

**[www.dfomer.com](http://www.dfomer.com)**



PUR1108 May 2023

[www.dfomer.com](http://www.dfomer.com)