



Carmit	1	Gel	27	Agas	53
Skincare	2	TW	28	Diana	54
JP	3	NY	29	Pro v	55
Dafna	4	NY ALE	30	OV	56
HW	5	NYCR	31	SQM	57
Balls	6	NYB	32	EST	58
Sandra	7	NYD	33	Balance	59
Mali	8	RD	34	Foam	60
Kopa	9	LA	35	Med	60
Nicole	10	Formula	36	Smadar	61
DP	11	Sapir	37	Talc	61
DG	12	Zohar	38	Paamon	62
Double Wall	13	Candela	39	Gaya	63
Body	14	NF	40	Teamo	63
Nature	15	Talia	41	IND	64
Lilian	16	Japan	42	Special 1 to 200	65
Inbar	17	E	43	Special 201 to 500	66
Luca	18	Life	44	Special 501 to 1000	67
Vitamin E	19	Prina	45	One Liter	68
Milk	20	Yafit	46	MG	69
Gever	21	Claudia	47	SASA	69
Malben	22	Amigos	48	WS	70
SW	23	Tubes	49	LYN	71
Botanic	24	Gali	50	SAN	72
Rollon	25	SQ-TR	51	NL	73
Aroma	26	Biss	52	NETA	74

SANWA

Packaging and Plastic goods
 18 Tnuva St. Beer Tuvia Industrial Zone 83815, ISRAEL
 Tel. +972 8 86 000 18 • Fax. +972 8 86 000 98
 e-mail: info@sanwa.co.il • website: www.sanwa.co.il



INDEX

Agas	53	IND	64	Paamon	62
Amigos	48	Japan	42	Pnina	45
Aroma	26	JP	3	Pro v	55
Balance	59	Kopa	9	RD	34
Balls	6	LA	35	Rollon	25
Biss	52	Life	44	SASA	69
Body	14	Lilian	16	SAN	72
Botanic	24	Luca	18	Sandra	7
Candela	39	LNY	71	Sapir	37
Carmit	1	Malben	22	Skincare	2
Claudia	47	Mali	8	Smadar	61
Dafna	4	Med	60	Special 1 to 200	65
DG	12	MG	69	Special 201 to 500	66
Diana	54	Milk	20	Special 501 to 1000	67
Double Wall	13	Nature	15	SQM	57
DP	11	NETA	74	SQ-TR	51
E	43	NF	40	SW	23
EST	58	Nicole	10	Talc	61
Foam	60	NL	73	Talia	41
Formula	36	NY	29	Teamo	63
Gali	50	NY ALE	30	Tubes	49
Gaya	63	NYB	32	TW	28
Gel	27	NYCR	31	Vitamin E	19
Gever	21	NYD	33	WS	70
HW	5	One Liter	68	Yafit	46
Inbar	17	OV	56	Zohar	38

SANWA

Packaging and Plastic goods

18 Tnuva St. Beer Tuvia Industrial Zone 83815, ISRAEL
 Tel. +972 8 86 000 18 • Fax. +972 8 86 000 98
 e-mail: info@sanwa.co.il • website: www.sanwa.co.il

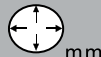

CARMIT

Ref	Vol cc	 mm	 mm	Cap	Neck Finish	Material
-----	-----------	--	--	-----	----------------	----------

Bottles



180	180	156	55	LP+OV 328	28/410	PP
181	180	126	55	CARMIT 320	Special	PP
226	200	175	47	LP/DT/SP	24/415	PE
283	280	197	55	LP+OV 328	28/410 24/410	PP
284	280	167	55	CARMIT 320	Special	PP

Jars

306-329	30	43	55	CARMIT 320	Special	PP
340-329	50	56	55	CARMIT 320	Special	PP
306-326	30	43	63	CARMIT 320	Special	PP
340-326	50	56	63	CARMIT 320	Special	PP
214-246	50	46	60	ST13/ST21/D/ AL/ALU18/R3	58/400	PP



SKINCARE

Ref	Vol cc	 mm	 mm	Cap	Neck Finish	Material
-----	--------	--	--	-----	-------------	----------

Bottles

263	250	180	42x71	LP+Overcap 203	28/410	PE/PP
356	330	196	46x74	sw128		PE/PP

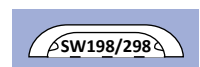
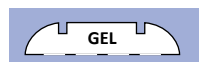
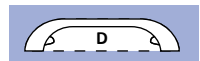
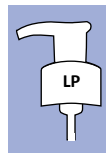
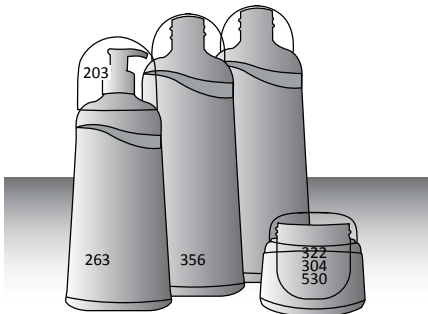

Jars

322	50	67	71	SW198/298	Special	PP
455	250	77	99	D 454	83/400	PP
528	500	86	106	ST15/D 454 /AL	83/400	PE
530	500	93	107	GEL	Special	PP





JP

Ref	Vol cc	 mm	 mm	Cap	Neck Finish	Material
92	100	40	94	ST16/ST25/AL/R3/ALU16/ ALU25/NYJ/D/GAL	89/400	PET
2100	100	43	73	ST12 /ST20 / D	70/400	PET
2150	150	53	73	ST12 /ST20 / D	70/400	PET
198	180	49	94	ST16/ST25/AL/R3/ALU16/ ALU25/NYJ/D/GAL/CARMIT	89/400	PET
245	250	61	94	ST16/ST25/AL/R3/ALU16/ ALU25/NYJ/D/GAL /CARMIT	89/400	PET
399	350	68	94	ST16/ST25/AL/R3/ALU16/ ALU25/NYJ/D/GAL /CARMIT	89/400	PET
545	500	95	94	ST16/ST25/AL/R3/ALU16/ ALU25/NYJ/D/GAL /CARMIT	89/400	PET
1016	1000	172	93	ST16/ST25/AL/R3/ALU16/ ALU25/NYJ/D/GAL /CARMIT	89/400	PET

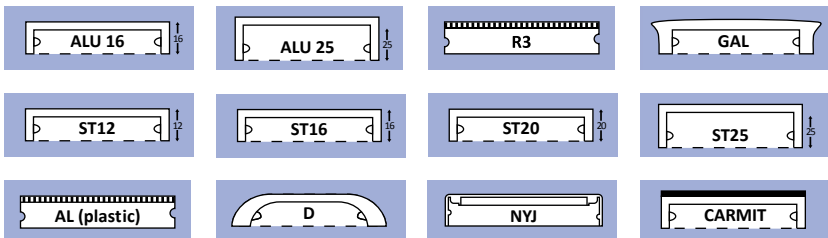

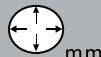

DAFNA

Ref	Vol cc	 mm	 mm	Cap	Neck Finish	Material
-----	-----------	--	--	-----	----------------	----------

Bottles

287A	250	158	43x70	SP/LP	24/410	PP/PE
287B	250	163	43x70	FT 410	Special	PP/PE
326A	330	184	43x74	SP/LP	24/410	PP/PE
326B	330	192	43x74	FT 410	Special	PP/PE

Jars

376	50	46	75	SW374/375	Special	PP
-----	----	----	----	-----------	---------	----

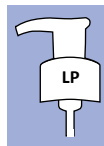
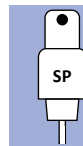
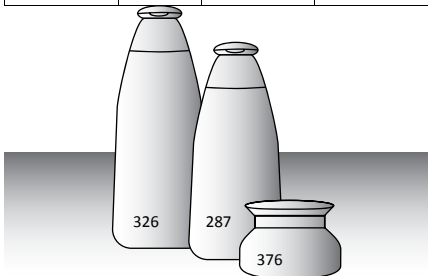



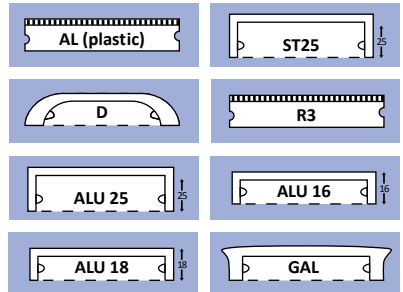

Ref	Vol cc	 mm	 mm	Cap	Neck Finish	Material
382	10	26	33	A	Special	PS
469	15	28	60	ST13/ST21/D/AL/ALU18/R3	58/400	PP
477	30	33	60	ST13/ST21/D/AL/ALU18/R3	58/400	PP
478	50	46	60	ST13/ST21/D/AL/ALU18/R3	58/400	PP
143	50	45	70	188-189	Special	Acrylic
173	50	47	60	ST13/ST21/D/AL/ALU18/R3 /ST22 ABS	58/400	PETG
247	50	45	56	ST13 Special 249	53/400	PP
7924	50	39	68	ST13/ST21/D/AL/ALU18/R3	58/400	Glass
470	60	32	71	ST12/ST20/D	70/400	PP
490	150	38	91	ST16/ST25/AL/R3/ALU16/ALU25/D/GAL	89/400	PP
439	250	56	91	ST16/ST25/AL/R3/ALU16/ALU25/D/GAL	89/400	PP
252 S	250	56	91	ST16/ST25/AL/R3/ALU16/ALU25/D/GAL	89/400	PP
451	400	71	103	ST18	100/400	PP

S = Shiny





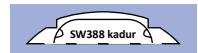
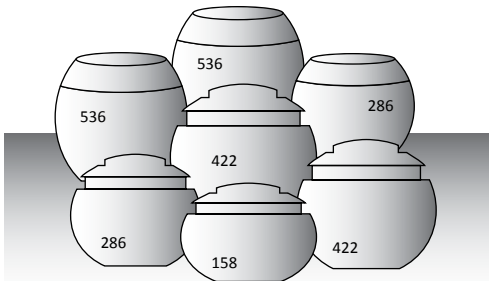

BALLS

Ref	Vol cc	 mm	 mm	Cap	Neck Finish	Material
158	150	69	100	SW388/430	Special	PP
158-397/98	3x20	69	100	SW388/430	Special	PP
286	250	80	100	SW388/430	Special	PP
2300	300	75	90	Special	Special	PET
422	400	78	106	SW388/430	Special	PP/ PVC
536	500	88	110	SW388/430	Special	PP/ PVC







SANDRA

Ref	Vol cc	 mm	 mm	Cap	Neck Finish	Material
131	100	120	39	LP/FT/DT	24/410	PE/PP
132	120	126	41	LP/FT/DT	24/410	PE/PP
134	150	134	45	LP/FT/DT	24/410	PE/PP
150 A	150	118	47	LP/FT/DT	24/410	PE/PP
150 B	150	114	47	FT 410	Snap	PE/PP
215	220	120	56	LP/FT/DT	24/410	PE
224	240	146	54	LP/FT/DT	28/410	PE/PP
225 A	240	146	54	LP/FT/DT	24/410	PE/PP
225 B	240	142	54	FT 410	Snap	PE/PP
246 A	230	173	47	LP/FT/DT	24/410	PE/PP
246 B	230	168	47	FT 410	Snap	PE/PP
279 A	250	173	47	LP/FT/DT	24/410	PE/PP
279 B	250	169	47	FT 410	Snap	PE/PP
323	300	151	59	LP/FT/DT	28/410	PE/PP
299	300	190	52	LP/FT/DT	24/410	PE/PP
359 A	350	187	57	LP/FT/DT	24/410	PE/PP
359 B	350	183	57	FT 410	Snap	PE/PP
565	500	157	75	LP/FT/DT	28/410	PE/PP
547	500	195	64	LP/FT/DT	24/410	PE/PP
1014	1000	197	91	LP/FT/DT	28/410	PE/PP
1018	1000	263	77	LP/FT/DT	28/410	PE/PP
1021	1160	286	77	LP/FT/DT	28/410	PE/PP



SANDRA

Ref	Vol cc	 mm	 mm	Cap	Neck Finish	Material
-----	--------	--	--	-----	-------------	----------

Bottles

1103	100	125	39	LP/SP/DT /FT	24/410	PET
149	150	150	42	LP/DT	24/410	PET
277	250	173	49	LP/FT/DT	24/410	PET
1506	500	235	59	LP/SP/DT /FT	28/410	PET

Jars

447 M	30	38	71	D/ST16/AL/CB	58/400	PP
476 M	50	49	71	D/ST16/AL/CB	58/400	PP
177 S	50	49	69	D/ST16/AL/CB	58/400	PP
540/446	250	80	108	D/ST16/AL/NYJ	89/400	PP
540	500	79	108	D/ST16/AL/NYJ	89/400	PP

M = Matt

S = Shiny



MALI



Ref	Vol cc	mm	mm	Cap	Neck Finish	Material
483	50	28	68	SW 484	Special	PP
217	100	45	70	SW 312	Special	PP
191A M&S	200	41	99	SW 459	Special	PP
191B S	2x100	41	99	SW 459	Special	PP

M = Matt

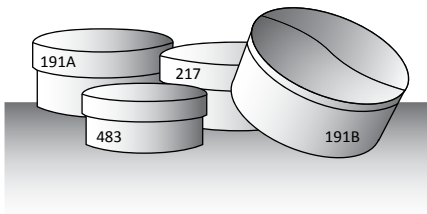
S = Shiny



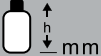

Ref	Vol cc	 mm	 mm	Cap	Neck Finish	Material
-----	--------	--	--	-----	-------------	----------

Bottles

103	100	125	40	SW42	Special	PE
101	125	132	42	SW40	Special	PE
111	125	130	42	LP / SP / DT	20/410	PE
251	250	147	57	SW56	Special	PE
351	350	184.5	57	Cos.75 / LP / SP	24/410	PP
358	350	190	57	SW56	Special	PE

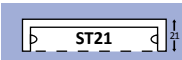
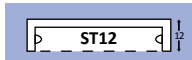
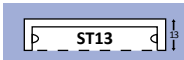
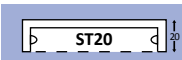
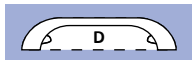

Jars

483	50	28	68	SW484	Special	PP
217	100	45	70	SW312	Special	PP
425	125	70	57	ST13/ST21/D/AL/ALU18/R3	58/400	PP
117	150	69	69	SW312 -316	Special	PP
141	150	60	71	ST12/ST20/D	70/400	PETG
251	250	93	69	SW312 -316	Special	PP





NICOLE

Ref	Vol cc	 mm	 mm	Cap	Neck Finish	Material
-----	--------	--	--	-----	-------------	----------

Bottles

276	250	148	84x54	FT410	Special	PP
362	350	159	84x54	LP	24/410	PP
458	400	193	84x54	FT 410	Special	PP

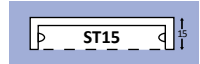
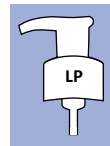
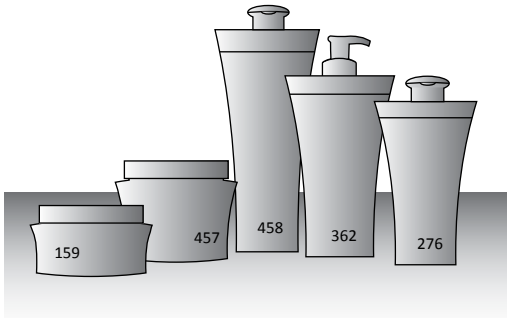

Jars

159	200	53	103x89	ST15 / AL	83/400	PP
457	400	84	105x90	ST15 / AL	83/400	PP





DP

Ref	Vol CC	 mm	 mm	Cap	Neck Finish	Material
138 S	50	38	72	ST12/ST20/D	70/400	PP
163 M	50	38	72	ST12/ST20/D	70/400	PP
133 S	100	49	72	ST12/ST20/D	70/400	PP
170/507 DPH S	200	67	92	ST16/ST25/AL/R3/ ALU16/ALU25/D/GAL	89/400	PP
170/508 DPH S	250	67	92	ST16/ST25/AL/R3/ ALU16/ALU25/D/GAL	89/400	PP
506/507 M	200-54	67	92	ST16/ST25/AL/R3/ ALU16/ALU25/D/GAL	89/400	PP
506/508 M	250-54	67	92	ST16/ST25/AL/R3/ ALU16/ALU25/D/GAL	89/400	PP
509/507 S	200-54	67	92	ST16/ST25/AL/R3/ ALU16/ALU25/D/GAL	89/400	PP
509/508 S	250-54	67	92	ST16/ST25/AL/R3/ ALU16/ALU25/D/GAL	89/400	PP
499/500 M	250-66	80	70	ST16/ST25/AL/R3/ ALU16/ALU25/D/GAL	89/400	PP
169 S	250	100	70	ST12/ST20/D	70/400	PP

M = Matt S = Shiny

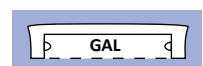
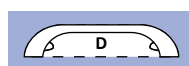
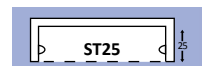
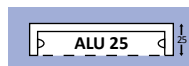
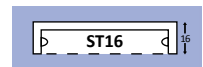
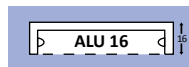
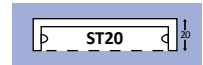
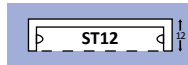
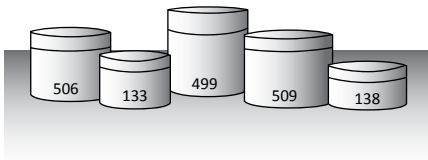

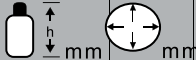

DG

Ref	Vol cc		Cap	Neck Finish	Material
-----	--------	---	-----	-------------	----------

Bottles

1061	60	75	41	DT/SP	20/410	PET
88	100	105	41	SP / DT / LP	24/410	PE
1212	200	105	60	SP / DT / LP	24/410	PET
194	250	105	67	SP / DT / LP	28/400	PE
1302	300	143	61	SP / DT / LP	24/410	PET
1320	320	182	53	SP / DT / LP	28/410	PET
373	350	124	72	SP / DT / LP	28/400	PE
1407	400	139	72	SP / DT / LP	28/410	PET
507	500	125	86	SP / DT / LP	28/400	PE
1509	500	160	72	SP / DT / LP	28/410	PET

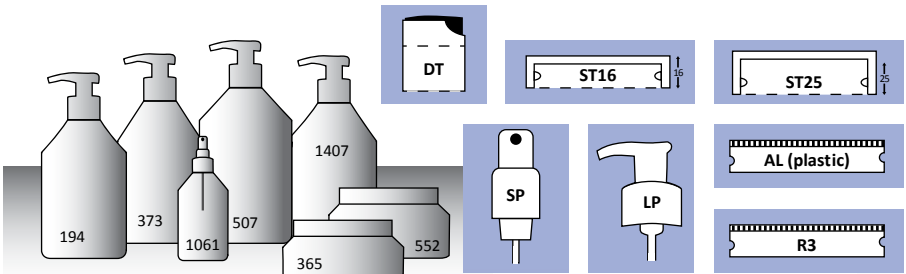

Jars

365	350	58	110	ST16/ST25/AL/R3/ALU16/ ALU25	89/400	PET
552	500	73	110	ST16/ST25/AL/R3/ALU16/ ALU25	89/400	PET





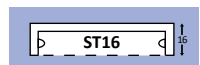
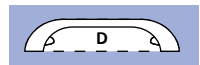
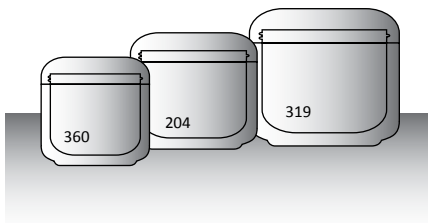

DOUBLE WALL

Ref	Vol cc	 mm	 mm	Cap	Neck Finish	Material
212	50	48	62	D SW280	Special	PP
360	50	51	62	D SW280	Special	PP
317	100	60	71	D SW316 / SW312 / SW256	Special	PP
408	100	60	71	D SW316 / SW312 / SW256	Special	PP
204/220	220	67	93	D SW294/ AL / ST16	89/400	PP
319/220	230	79	93	D SW294/ AL / ST16	89/400	PP
196	300	95	93	D SW363 / D SW338	Special	PP





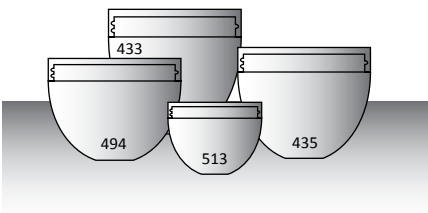
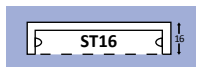
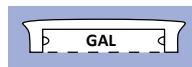
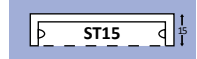
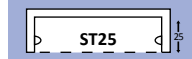
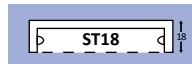

BODY

Ref	Vol cc	 mm	 mm	Cap	Neck Finish	Material
513	50	37	55	SW 522 / SW536	Special	PP
494	200	63	86	AL / ST15	83/400	PP
435	300	68	92	GAL / AL / ST16 / ST25	89/400	PP
2301	300	69	92	GAL / AL / ST16 / ST25	89/400	PET
433	500	86	102	ST18	100/400	PP



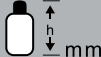

NATURE

Ref	Vol cc	 mm	 mm	Cap	Neck Finish	Material
-----	-----------	--	--	-----	----------------	----------

Bottles

182	150	164	50x60	SW372	Special	PP
307	300	198	54x65	SW372	Special	PP
456	450	216	69x79	SW372	Special	PP

Jars

376	50	46	75	SW374	Special	PP
271	250	67	99	SW374	Special	PP
308	350	79	99	SW374	Special	PP
600	600	120	99	SW374	Special	PP



LILIAN

Ref	Vol cc	 mm	 mm	Cap	Neck Finish	Material
-----	--------	--	--	-----	-------------	----------

Bottles

1152	150	123	46	LP / FT	24/410	PET
1330	330	135	62	LP / FT	28/410	PET
314	330	135	62	LP / FT	28/410	PE
1403	400	154	68	LP / FT	28/410	PET
430	400	154	68	LP / FT	28/410	PE
556	500	180	67	LP / FT	28/410	PE
1505	500	190	60	LP / FT	28/410	PET
1017	1000	204	86	LP / FT	28/410	PE
1997	1000	215	85	LP / FT	28/410	PET

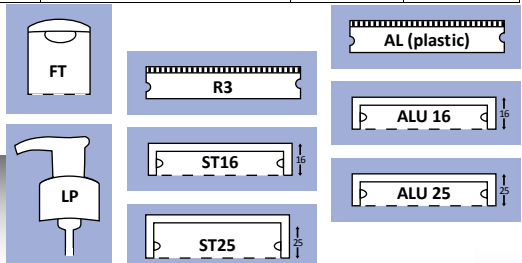

Jars

511	500	80	108	ST16 / ST25 / AL / R3 / ALU16 / ALU25	89/400	PE
2501	500	72	118	ST16 / ST25 / AL / R3 / ALU16 / ALU25	89/400	PET
596	500	82	109	ST16 / ST25 / AL / R3 / ALU16 / ALU25	89/400	PE





INBAR

Ref	Vol cc	 mm	 mm	Cap	Neck Finish	Material
1400	400	157	65	LP / FT	28/410	PET
1750	750	182	80	LP / FT	28/410	PET
1998	1000	230	85	LP / FT	28/410	PET

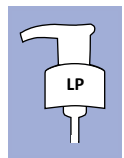



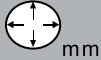

LUCA

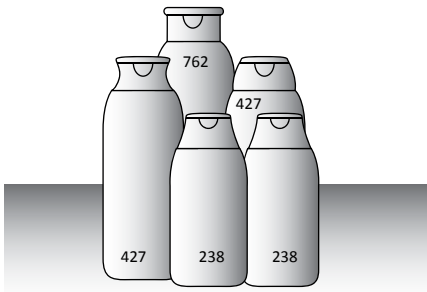
Ref	Vol cc	 mm	 mm	Cap	Neck Finish	Material
238	280	158	75	CB	Pco 28	PE
427	400	211	82	CB	Pco 28	PE
762	750	242	92	CB	Pco 28	PE





VITAMIN E

Ref	Vol cc	 mm	 mm	Cap	Neck Finish	Material
411	400	163	80	LP / SP / DT / FT	28/410	PP
539	500	245	87	WP1001	Special	PP
543	500	175	80	LP / SP / DT / FT	28/410	PP

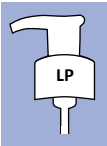
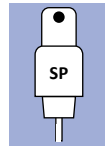
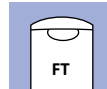
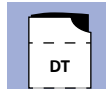



MILK

Ref	Vol CC	 mm	 mm	Cap	Neck Finish	Material
-----	--------	--	--	-----	-------------	----------

Bottles

146	150	134	49	LP / FT	24/410	PE
232	250	165	55	LP / FT	28/410	PE
321	300	164	60	FTP Flip Top Push NYB / DTP Disc Top Push NYD	Special Push	PE
489	500	195	69	LP/SP/DT/FT	28/410	PE
551	500	190	70	LP / FT	28/410	PE
563	500	205	64	FTP Flip Top Push NYB / DTP Disc Top Push NYD	Special Push	PE
1508	500	192	68	LP/SP/DT/FT	28/410	PET
1015	1000	230	88	LP / FT	38/410	PE
1996	1000	220	90	LP/SP/DT/FT	28/410	PET

Jars

474	500	82	108	ST16 / ST25 / AL / R3 / ALU16 / ALU25 / GAL	89/400	PE
2502	500	82	104	ST16 / ST25 / AL / R3 / ALU16 / ALU25 / GAL	89/400	PET

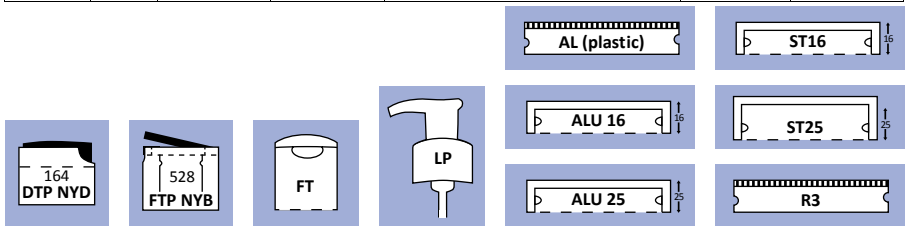



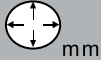

GEVER

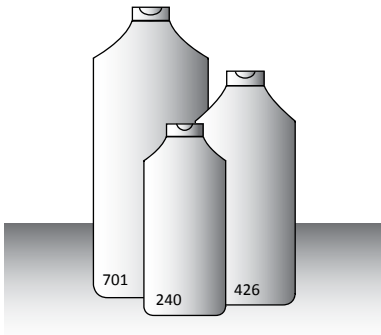
Ref	Vol cc	 mm	 mm	Cap	Neck Finish	Material
240	250	135	60	743	Special	PE
426	400	170	83	743	Special	PE
701	700	222	95	743	Special	PE





MALBEN

Ref	Vol cc	 mm	 mm	Cap	Neck Finish	Material
-----	-----------	--	--	-----	----------------	----------

Bottles

94	100	115	45	SP / DT / LP / FT	20/415	PET
96	100	108	49	SP / DT / LP / FT	20/415	PE/PP
1252	250	125	60	SP / DT / LP / FT	28/410	PET
217	250	118	90	SP / DT / LP / FT	28/410	PE
1301	300	170	75	SP / DT / LP / FT	28/410	PET
1409	400	165	80	SP / DT / LP / FT	28/410	PET
428	400	175	88	SP / DT / LP / FT	28/410	PET
396	400	184	74	SP / DT / LP / FT	28/410	PE
1501	500	193	88	SP / DT / LP / FT	28/410	PET

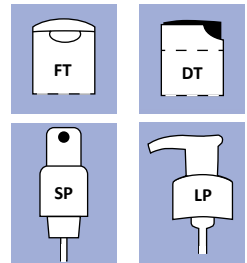
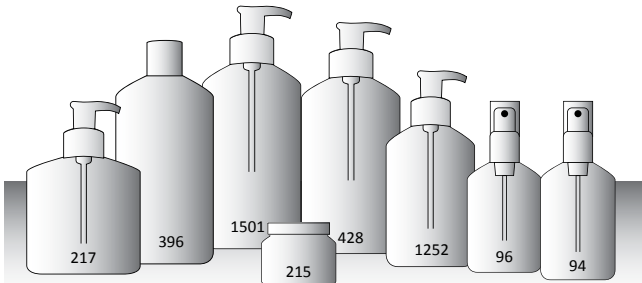

Jar

215	50	44	70X65	SW280 / ST16	Special	PP
-----	----	----	-------	--------------	---------	----





SW

Ref	Vol cc	 mm	 mm	Cap	Neck Finish	Material
-----	--------	--	--	-----	-------------	----------

Bottles

1100	100	117	42	LP / SP / DT / FT	24/410	PET
1205	200	148	52	LP / SP / DT / FT	24/410	PET
1255	250	163	55	LP / SP / DT / FT	24/410	PET
1260	250	163	55	LP / SP / DT / FT	28/410	PET
236	250	184	56x39	LP / SP / DT / FT	24/410	PE
289	280	154	61	LP / SP / DT / FT	28/410	PET
1406	400	200	50x60	LP / SP / DT / FT	24/410	PET

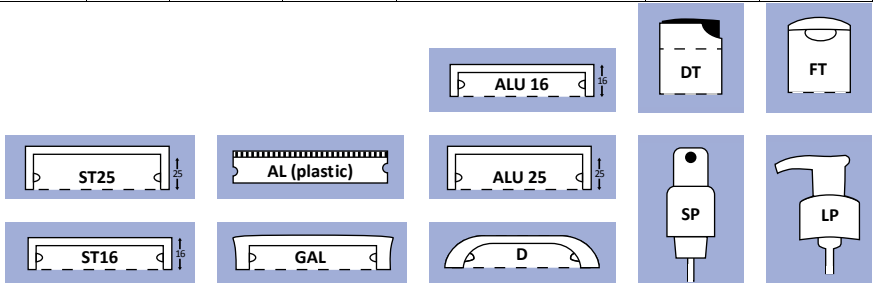

Jars

2250	250	62	92	ST16 / ST25 / ALU16 / ALU25 / D / AL / GAL	89/400	PET
184	250	61	92		89/400	PP
2352	350	77	92		89/400	PET
546	500	75	107		89/400	PE
279	500	87	100	ST18	100/400	PP
331	1000	135	110	sw336	Special	PP





BOTANIC

Ref	Vol cc	 mm	 mm	Cap	Neck Finish	Material
-----	--------	--	--	-----	-------------	----------

Bottles

227	200	182	48	LP	24/410	PP
534	500	204	69	LP	28/410	PP

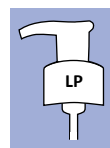
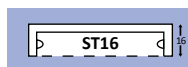

Jars

309	150	68	80	D Pro Botanic 310	Special	PP
226	250	82	95	D Pro Botanic 227	Special	PP
550	500	100	107x100	ST16	89/400	PP



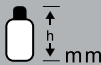

ROLLON

Ref	Vol cc	 mm	 mm	Cap	Neck Finish	Material
52	70	111	52x32	ROLL ON -343 A	Special	PE
57	70	116	48	ROLL ON -448	Special	PP
91	90	101	40x48	ROLL ON Cream -412	Special	PP
117	90	128	51x50	ROLL ON-385	Special	PP
119	90	130	57x44	ROLL ON -503	Special	PP
98	100	76	48	ROLL ON-343	Special	PP
61	90	114	57x44	ROLL ON -503	Special	PP

Ref	Material	 mm	 mm
-----	----------	--	--

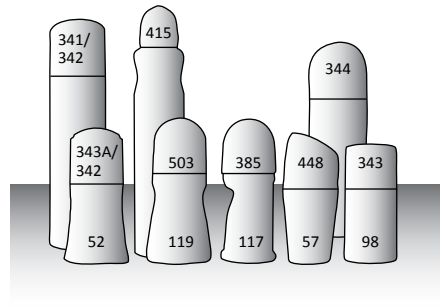

Caps

341/342	PP	48	46
343	PP	38	47
344	PP	37	53
385	PP	46	47
415	PP	30	34
448	PP	50	47
503	PP	47	47





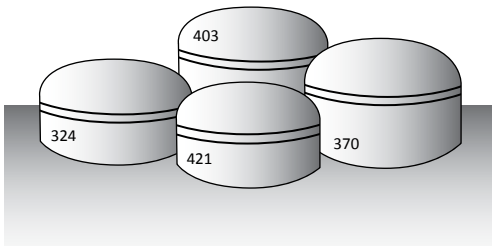

AROMA

Ref	Vol cc	 mm	 mm	Cap	Neck Finish	Material
421 A	50	38	86	sw419	70/400	HISP
421 B	60	38	86	sw419	70/400	HISP
324 A	100	54	93	sw313	83/400	HISP
324 B	125	54	93	SW313	83/400	HISP
370	150	66	93	SW159	83/400	HISP
403	150	67	93	SW159	83/400	HISP





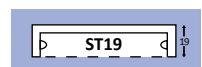
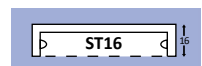
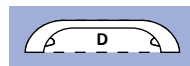
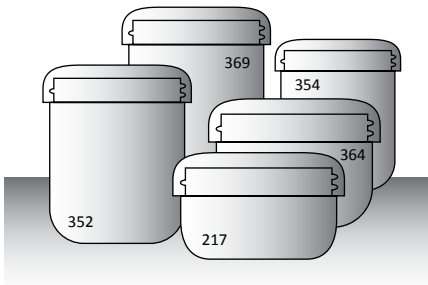

GEL

Ref	Vol cc	 mm	 mm	Cap	Neck Finish	Material
217	200	53	93	D / ST16 / AL	89/400	PP
364	300	72	93	D / ST16 / AL / GEL SW519	89/400	PP
352	400	82	91	GEL SW363	Special	PP
519	400	112	93	D / ST16 / AL / GEL SW519	89/400	PP
354	500	100	91	GEL SW363	Special	PP
221	500	103	92	D / ST16 / AL / GEL SW519	89/400	PP
369	1000	142	108	ST19 / D / GEL SW359 / SW495	118	PP



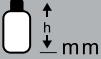

TW

Ref	Vol cc	 mm	 mm	Cap	Neck Finish	Material
225	100	36	72	ST12 / ST20 / D	70/400	PP
154 S	150	51	72	ST12 / ST20 / D	70/400	PP
186 S	250	60	91	ST16 / ST25	89/400	PP
514	300	64	89	ST16 / ST25	89/400	PP
511	500	95	89	ST16 / ST25	89/400	PP
135 S	500	60	118	ST19	118	PP
502	600	90	100	ST18	100/400	PP

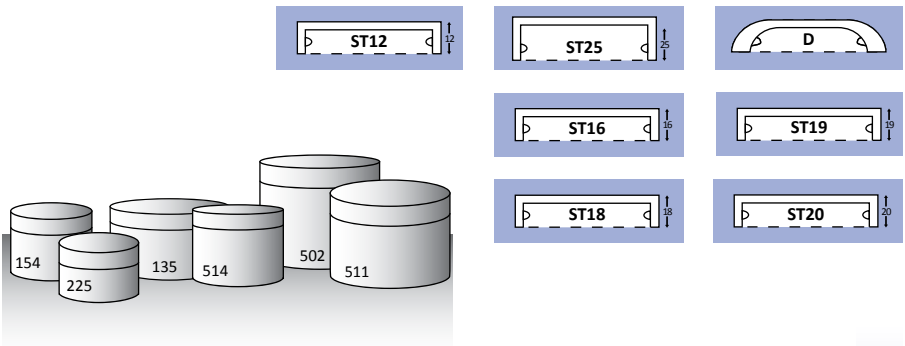

S = Shiny





NY



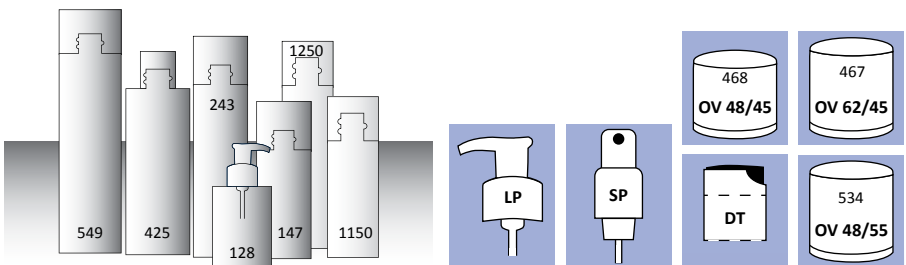

Ref	Vol cc	 mm	 mm	Cap	Neck Finish	Material
128	100	88	48	OV 48/45 -55 +SP/DT/LP	24/400 24/410 28/400	PE
147	150	110	48	OV 48/45 -55 +SP/DT/LP	24/400 24/410 28/400	PE
1150	150	95	48	OV 48/45 -55 +SP/DT/LP	24/410	PET
196	200	130	48	OV 48/45 -55 +SP/DT/LP	24/410	PE
1209	200	148	48	OV 48/45 -55 +SP/DT/LP	24/410	PET
1250	250	174	48	OV 48/45 -55 +SP/DT/LP	24/410	PET
243	250	180	48	OV 48/45 -55 +SP/DT/LP	24/400 24/410 28/400	PE
425	400	206	62	OV 62/45 -68 SP/DT/LP	28/410 28/400	PE
549	500	225	62	OV 62/45 -68 SP/DT/LP	28/410 28/400	PE





NY ALE

Ref	Vol cc	 mm	 mm	Cap	Neck Finish	Material
128	100	88	48	OV Ale +SP/DT/LP	24/400 24/410 28/400	PE
147	150	110	48	OV Ale +SP/DT/LP	24/400 24/410 28/400	PE
1150	150	95	48	OV Ale +SP/DT/LP	24/410	PET
196	200	130	48	OV Ale +SP/DT/LP	24/410	PE
1209	200	148	48	OV Ale +SP/DT/LP	24/410	PET
243	250	180	48	OV Ale +SP/DT/LP	24/400 24/410 28/400	PE
1250	250	174	48	OV Ale +SP/DT/LP	24/410	PET
425	400	206	62	OV Ale +SP/DT/LP	28/410 28/400	PE
549	500	225	62	OV Ale +SP/DT/LP	28/410 28/400	PE

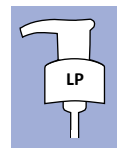
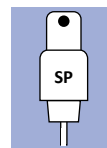
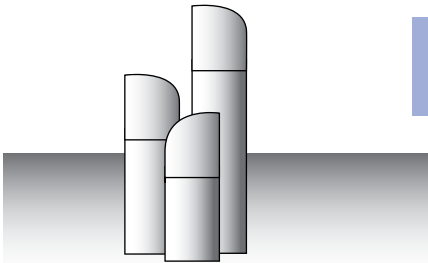



NYCR

Ref	Vol cc	 mm	 mm	Cap	Neck Finish	Material
59	50	95	30	Special	Special	PE
1060	60	82	39	Special	20/410	PET
130	100	97	48	Special Twist / NYAL	24/410	PE
1120	120	138	39	Special	20/410	PET
213	200	165	48	Special Twist / NYAL	Special	PE
293	250	194	48	Special Twist / NYAL	Special	PE
244	250	185	48	NYAL	24/415	PET

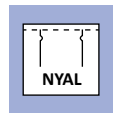
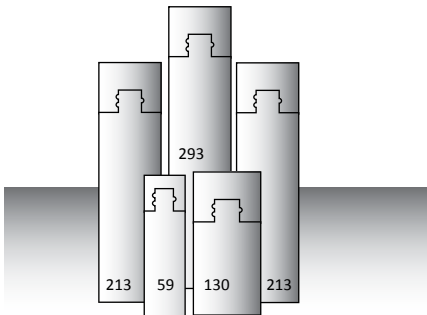



NYB

Ref	Vol cc	 mm	 mm	Cap	Neck Finish	Material
130	100	90	48	FTP Flip Top Push NYB	Special Push	PE
163	150	122	48	FTP Flip Top Push NYB	Special Push	PE
1150	150	117	48	FTP Flip Top Push NYB	24/410 - Special Push	PET
197	200	155	48	FTP Flip Top Push NYB	Special Push	PE
1209	200	148	48	FTP Flip Top Push NYB	24/410 - Special Push	PET
229	250	183	48	FTP Flip Top Push NYB	Special Push	PE
1257	250	176	48	FTP Flip Top Push NYB	24/410 - Special Push	PET
315	300	210	48	FTP Flip Top Push NYB	Special Push	PE
375	300	176	55	FTP Flip Top Push NYB	Special Push	PE
423	400	206	56	FTP Flip Top Push NYB	Special Push	PE

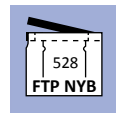
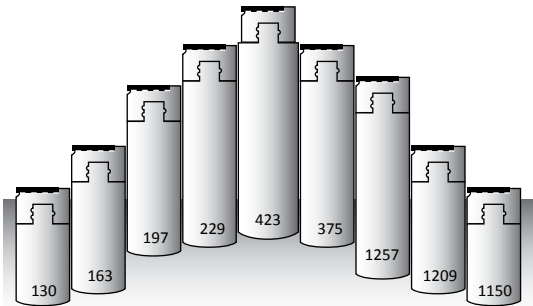

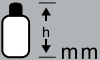
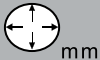

NYD

Ref	Vol CC	 mm	 mm	Cap	Neck Finish	Material
130	100	90	48	DTP Disc Top Push NYD	Special Push	PE
163	150	122	48	DTP Disc Top Push NYD	Special Push	PE
1150	150	117	48	DTP Disc Top Push NYD	24/410 - Special Push	PET
197	200	155	48	DTP Disc Top Push NYD	Special Push	PE
1209	200	148	48	DTP Disc Top Push NYD	24/410 - Special Push	PET
229	250	183	48	DTP Disc Top Push NYD	Special Push	PE
1257	250	176	48	DTP Disc Top Push NYD	24/410 - Special Push	PET
315	300	210	48	DTP Disc Top Push NYD	Special Push	PE
375	300	176	55	FTP Flip Top Push NYD	Special Push	PE
423	400	206	56	FTP Flip Top Push NYD	Special Push	PE

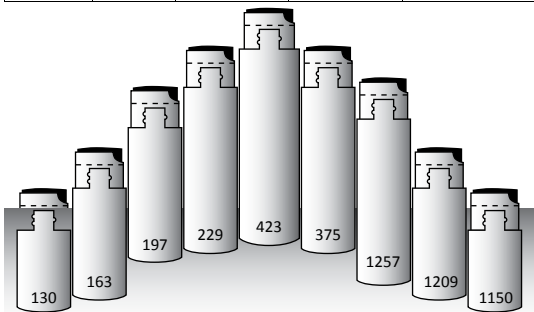



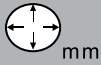

RD

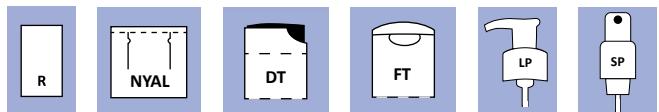
Ref	Vol cc	 mm	 mm	Cap	Neck Finish	Material
1070	75	105	36	LP/SP/DT /FT	20/410	PET
1102	100	119	39	LP/SP/DT /FT	24/410	PET
164	150	164	40	SP / LP / R	24/415	PET
1151	150	155	40	SP / DT / LP / FT	24/410	PET
1170	170	137	47	SP / DT / LP / FT	24/415	PET
210	200	120	54	SP / DT / LP / FT	28/410	PETG
1204	200	150	47	SP / DT / LP / FT	24/415	PET
1208	210	151	47	SP / DT / LP / FT / NYAL	24/415	PET
244	250	178	48	SP / NYAL / R / LP	24/415	PET
1251	250	148	54	SP / DT / LP / FT	24/410	PET
1254	250	170	48	SP / DT / LP / FT	24/410	PET
309	300	185	52	SP / NYAL / R / LP	24/415	PET
366	300	120	67	SP / DT / LP / FT	28/410	PETG
424	400	207	56	SP / NYAL / R / LP	24/415	PET
1402	400	194	56	SP / NYAL / R / LP	24/410	PET
1504	500	198	63	SP / DT / LP / FT	28/410	PET
1999	1000	217	84	SP / NYAL / R / LP	28/410	PET





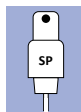
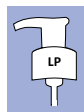
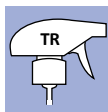

RD

Ref	Vol cc	 mm	 mm	Cap	Neck Finish	Material
70	70	95	35	LP / FT / DT	20/410	PE
192	200	115	56	Special	32/400	PE
208	200	142	52	SP / DT / LP / FT	24/415	PE
237	250	159	52	SP / DT / LP / FT	24/410	PE
369	300	169	54	SP / DT / LP / FT	24/410	PE
394	400	152	62	SP / DT / LP / FT	24/410	PE
505	500	201	67	SP / DT / TR	24/415	PE





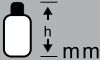

LA

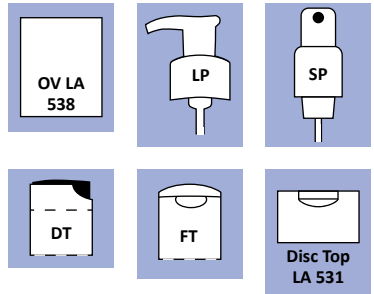
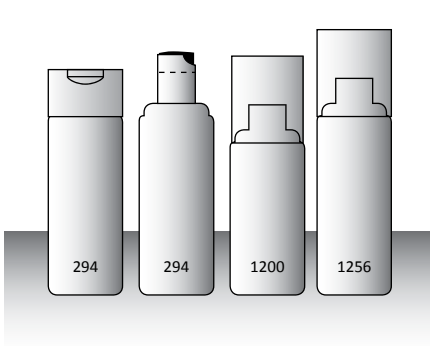
Ref	Vol CC	 mm	 mm	Cap	Neck Finish	Material
294	250	135	48x48	DT LA 531 / OV LA 538 SP / DT / LP / FT	Special	PP
1200	200	105	48x48	DT LA 531 / OV LA 538 SP / DT / LP / FT	24/410	PET
1256	250	153	48x48	DT LA 531 / OV LA 538 SP / DT / LP / FT	24/410	PET





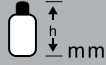

FORMULA

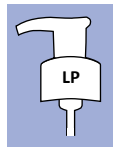
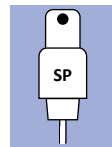
Ref	Vol cc	 mm	 mm	Cap	Neck Finish	Material
269	250	172	60x46	SP / LP	28/410	PE/PP
270	250	174	60x43	SP / LP	20/410	PVC
281	250	115	100x46	SP / LP	28/410	PE
418	400	178	68x62	SP / LP	28/410	PE/PP
419	400	178	68x62	SP / LP	28/410	PE/PP



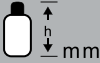

SAPIR

Ref	Vol cc	 mm	 mm	Cap	Neck Finish	Material
-----	--------	--	--	-----	-------------	----------

Bottles

1075	75	94	42	SW527 / LP / DT	24/410	PET
1101	100	119	42	SW527 / LP / DT	24/410	PET
218	220	144	44	SW174	28/410	PET
1259	250	157	54	SW527 / LP / DT	24/410	PET

Jars

50XLA	50	48	70	Special	Special	Acrylic
518	200	68	92	ST16/ST25/ALU16/ALU25/AL	89/400	PP
517	250	78	92	ST16/ST25/ALU16/ALU25/AL	89/400	PP
239	250	67	92	ST16/ST25/ALU16/ALU25/AL	89/400	PET

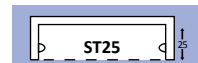
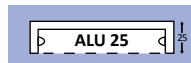
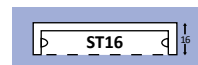
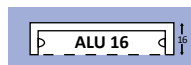
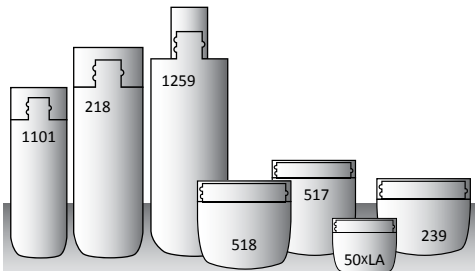

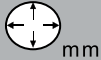

ZOHAR

Ref	Vol CC	 mm	 mm	Cap	Neck Finish	Material
-----	--------	--	--	-----	-------------	----------

Bottles

193	200	185	60x40	FT	24/415	PE
219	236	157	74x35	LP/DT/FT/SP	24/410	PP
256	250	205	70	FT	20/415	PE
272	250	171	36x76	wp1010	Special	PE
342	350	180	90x47	PCF 003	Special	PE
363	350	193	90x36	wp1010	Special	PP
370	350	170	47x87	LP/DT/FT/SP	28/410	PP
434	400	185	82x48	LP/DT/FT/SP	28 mm 28/410	PE
391	400	162	99x 43	CB	Special28	PP
465	500	177	95x62	LP/DT/FT/SP	28/410	PE
1401	400	177	82.5x45	CB	Pco 28	PET
538	500	230	45x90	wp1010	Special	PE
768	750	222	98x60	LP/DT/FT/SP	28 mm 28/410	PE
1753	750	226	97x60	LP/DT/FT/SP	28/410	PET
1031	1000	263/258	109x61	LP/DT/FT/SP	28 mm 28/410	PE

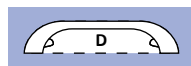
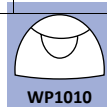
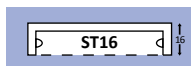
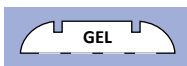

Jars

532	500	78	99x120	D / GEL	Special	PE
1008	1000	108	125x148	GEL	118/400	PP
282	280	67	72x98	D / ST16	70	PE
529	500	77	94x116	D	Special	PE





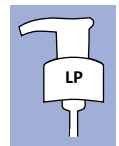
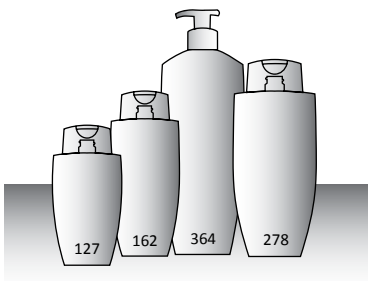

CANDELA

Ref	Vol cc	 mm	 mm	Cap	Neck Finish	Material
127	100	121	62x34	WP1005	Special	PE/PP
162	150	154	62x34	WP1005	Special	PE/PP
278	250	175	73x40	WP1005	Special	PE/PP
364	350	195	79x44	LP	28/410	PE/PP





NF

Ref	Vol cc	 mm	 mm	Cap	Neck Finish	Material
-----	--------	--	--	-----	-------------	----------

Bottles

328	300	118	67	LP	28/410	PP
-----	-----	-----	----	----	--------	----

Jars

273	250	62	91	AL/D	83/400	PP
2350	350	72	98	ST16/ST25/AL/R3/ ALU16/ALU25/D/GAL	89/400	PET
421	400	88	91	AL/D	83/400	PP
544	500	100	91	AL/D	83/400	PVC
2500	500	95	98	ST16/ST25/AL/R3/ ALU16/ALU25/D/GAL	89/400	PET

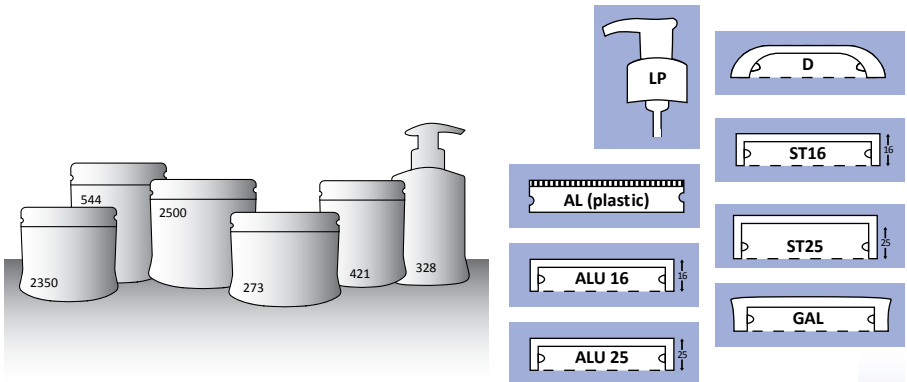



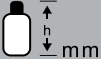
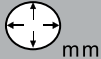

TALIA

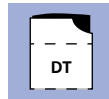
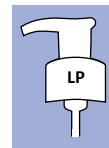
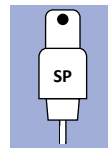
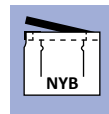
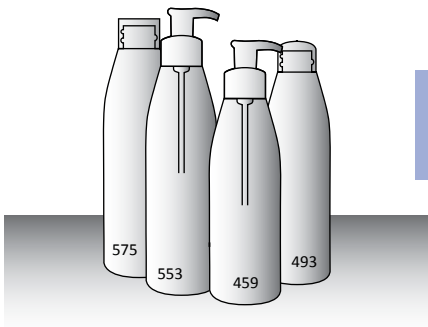
Ref	Vol cc	 mm	 mm	Cap	Neck Finish	Material
62	60	87	38	DT / LP / SP / FT	20/410	PE
145	150	130	46	DT / LP / SP / FT	24/410	PE
1154	150	130	46	DT / LP / SP / FT	24/410	PET
1240	240	166	50	DT / LP / SP / FT	24/411	PET
459	400	190	62	LP	28/410	PE
471	400	190	62	LP	28/410	PE
493	400	210	62	DT	24/410	PE
553	500	230	62	LP	24/410 28/410	PE
575	550	245	62	DS / NYB	24/410	PE
764	750	233	74	DT / LP / SP / FT	28/410	PE





JAPAN

Ref	Vol cc	 mm	 mm	Cap	Neck Finish	Material
268	250	175	79x33	Japan 255	Special	PVC
285	250	176	79x33	Japan 255	Special	PP/PE
303	300	175	91x42	Japan 255	Special	PP/PE
405	400	138	108x58	Japan 255	Special	PP/PE
409	400	197	92x41	Japan 255	Special	PP/PE

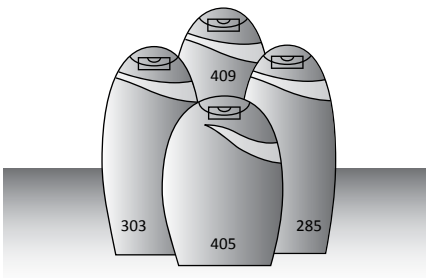

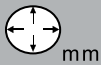

E

Ref	Vol cc	 mm	 mm	Cap	Neck Finish	Material
115	125	135	34x53	WP1005	Special	PE/PP
157	150	145	38x56	WP1001	Special	PE/PP
202	200	164	41x66	WP1001	Special	PE/PP
260	250	191	41x66	WP1001	Special	PE/PP
1267	250	150	66x42	Pco 28	28/410	PET
414	400	169	46x88	LP	28/410	PE/PP
1408	400	165	84x46	LP/DT/FT/SDP	28/410	PET
490	500	198	50x93	WP1001	Special	PE
533	500	229	47x88	WP1001	Special	PE/PP
1007	1000	273	57x99	wp1001	Special	PE/PP



LIFE

Ref	Vol cc	 mm	 mm	Cap	Neck Finish	Material
166	150	140	62	Special	Special	PP / PE
234	200	141	68	EC 6	Special	PE
241	250	165	67	Special	Special	PP / PE
554	500	177	84	LP / DT	28/410	PE
760	750	228	89	SW510	Special	PE

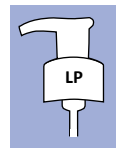
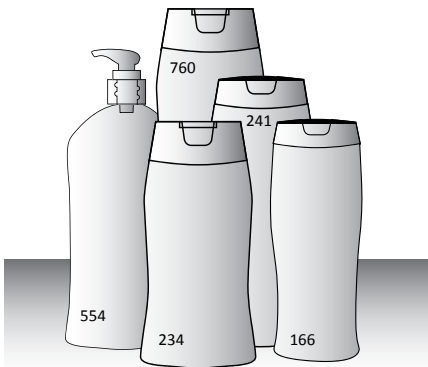



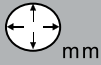

PNINA

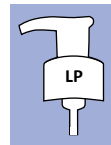
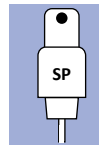
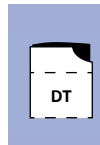
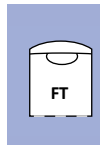
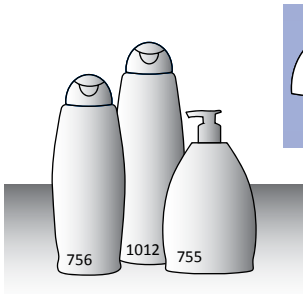
Ref	Vol cc	 mm	 mm	Cap	Neck Finish	Material
537	500	172	88x72	DT / LP / SP / FT	28/410	PE
755	750	180	113x70	DT / LP / SP / FT	28/410	PE
756	750	232	80x69	1013	Special	PE
1012	1000	271	83x72	1013 SW544	Special	PE





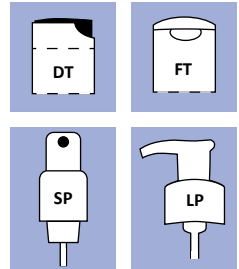

YAFIT

Ref	Vol cc	 mm	 mm	Cap	Neck Finish	Material
1203	200	151	65x36	LP / SP / DT / FT	24/410	PET
1404	400	167	73	LP / SP / DT / FT	28/410	PET
1751	750	222	90	Cap Zeus	29/21	PET





CLAUDIA

Ref	Vol cc	 mm	 mm	Cap	Neck Finish	Material
-----	--------	--	--	-----	-------------	----------

Bottles

58	60	105	41x28	DT / SP / LP	20/415	PET
95	100	117	48x33	DT / SP / LP	20/415	PE
120	110	115	47x32	DT / SP / LP	20/415	PET
275	250	184	68x36	DT / SP / LP	24/415	PE
431	400	200	80X50	ST / LP / DT / FT	24/415	PE

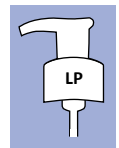
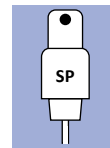
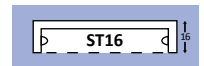

Jars

381	50	43	67x80	ST16	53	PP
-----	----	----	-------	------	----	----





AMIGOS

Ref	Vol cc	 mm	 mm	Cap	Neck Finish	Material
99	110	96	53	LP	24/410	PE
497	380	152	79	LP	24/410	PE
496	390	149	78	LP	24/410	PE
495	420	152	80	LP	24/410	PE
498	420	150	81	LP	24/410	PE
499	460	152	84	LP	24/410	PE

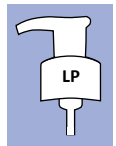
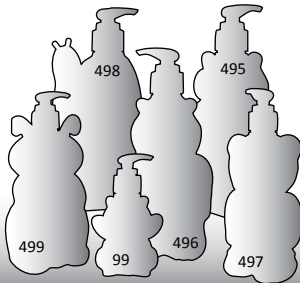



TUBES

Ref	Vol cc	mm	mm	Cap	Neck Finish	Material
53	60	142	30x65	WP1002	Special	PE
97	100	134	37x63	FT/DT	24/410	PE
125	125	155	38x50	40	Special	PE
154	125	127	47x70	50	Special	PE
155	150	130	47x70	50	Special	PE
261	250	196	49x71	50	Special	PE

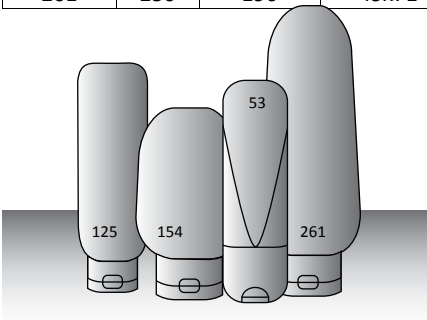

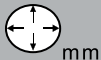

GALI

Ref	Vol cc	 mm	 mm	Cap	Neck Finish	Material
-----	--------	--	--	-----	-------------	----------

Bottles

126	125	131	31x67	WP1005	Special	PP
249	250	163	38x78	LP	24/410	PP
250	250	182	38x78	WP1005	Special	PP
500	500	220	49x92	WP1005	Special	PP
542	500	215	53x92	WP1005	Special	PP

Jars

381	50	43	67x80	ST16	53	PP
455	450	99	75x93	D / ST16	70/400	PP

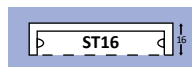
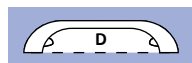
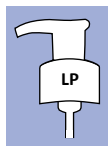
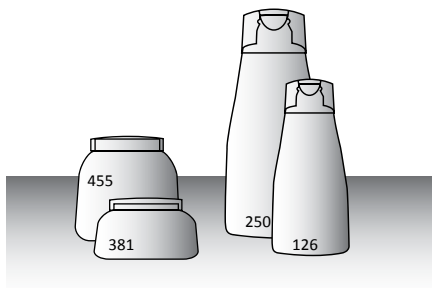

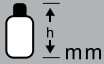
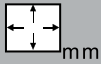

Ref	Vol cc	 mm	 mm	Cap	Neck Finish	Material
-----	--------	--	--	-----	-------------	----------

SQ

Bottles

1062	60	63	34x34	SP/LP/FT/DT	20/410	PET
1153	150	130	44x44	SP/LP/FT/DT	24/415	PET
1201	200	130	48x48	SP/LP/FT/DT	24/410	PET
752	750	200	65x65	LP	28/400	PE

Jars

561	500	74	99X99	ST16/ST25/D/ALU/AL/GAL	89/400	PE
597	550	80	99X99	ST16/ST25/D/ALU/AL/GAL	89/400	PE

TR

1211	200	136	65x37	SP/LP/FT/DT	24/415	PET
1202	200	102	65x48	SP / DT / LP / FT	28/410	PET
1502	500	195	65x48	SP / DT / LP / FT	28/410	PET
1503	500	128	85x62	SP / DT / LP / FT	28/410	PET
559	500	155	60x79	SP / DT / LP / FT	28/410	PE
1019	1000	210	70x96	SP / DT / LP / FT	28/410	PE
1028	1000	172	95x86	Pump	33/400	PE

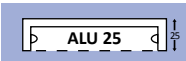
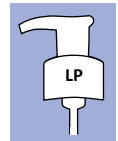
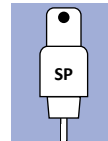
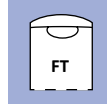
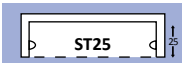
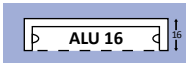
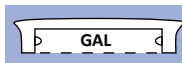
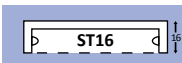



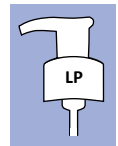
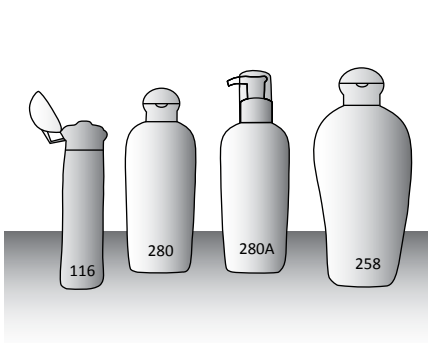

BISS

Ref	Vol cc	 mm	 mm	Cap	Neck Finish	Material
116	120	141	32x58	WP1208	Special	PE
258	250	183	30x82	wp1208	Special	PE
280 A	280	163	43x69	LP	28/400 28/410	PE
280 B	280	180	43x69	WP1208	Special	PE
404	400	192	48x82	WP1208	Special	PE







AGAS

Ref	Vol cc	 mm	 mm	Cap	Neck Finish	Material
102	100	119	30x60	15	Special	PE
135	150	156	68x37	LP / DT / FT	24/415	PE
247	250	189	65x53	LP / DT / FT	24/410	PP
248	250	174	74x42	LP / DT / FT	28/410	PVC
1253	250	155	35x80	LP / DT / FT	24/410	PET
349	350	198	40x88	LP / DT / FT	28/410	PE
402	400	190	45x86	70	Special	PE
1405	400	210	35x83	LP / DT / FT	28/410	PET
460	400	214	81	SP / DT / LP	28/410	PVC
510	500	225	90x45	NA	Special	PE
1001	1000	254	55x106	sw42	Special	PE



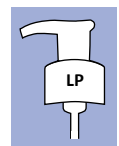
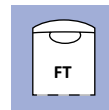
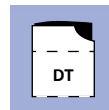
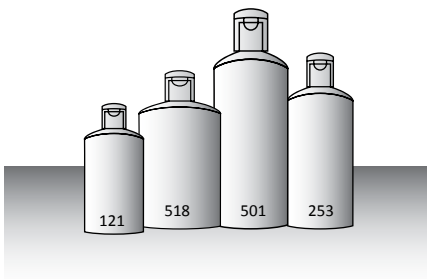

DIANA

Ref	Vol cc	 mm	 mm	Cap	Neck Finish	Material
121	100	114	56x27	LP/DT/FT	20/410	PE
253	250	179	37x71	70	Special	PP
501	500	240	45x87	70	Special	PP
518	500	141	71x85	LP	28/410	PP





PRO V

Ref	Vol cc	 mm	 mm	Cap	Neck Finish	Material
201	200	177	36x66	FT	24/410	PVC
201A	200	177	36x66	DT / LP	24/410	PP
223	250	182	38x70	Snap	Special	PE
350	350	180	42x77	DT / LP	28/410	PE
406	400	181	45x84	Coster 233	28/410	PVC
415	400	181	45x84	LP	28/410	PE
516	500	234	45x89	FT 800	Special	PP/PE
519	500			P 1000	28/400	PE
520	500	235	45x88	wp1001	Special	PE
522	500	147	67x90	LP	28/400	PE
526	500			Zeller	Special	PE
754	750	214	59x 103	WP1104	Special	PE



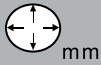

OV

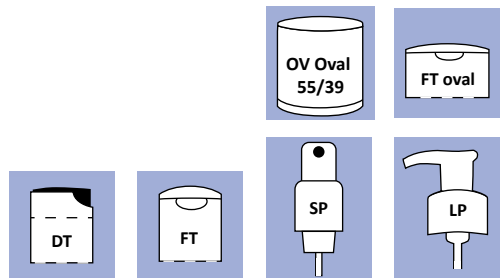
Ref	Vol CC	 mm	 mm	Cap	Neck Finish	Material
122	150	131	55x39	Overcap OVAL 55x39 + LP/SP/DT/FT + FT Oval	24/410	PE
178	200	164	55x39	Overcap OVAL 55x39 + LP/SP/DT/FT + FT Oval	24/410	PE
195	250	195	55x39	Overcap OVAL 55x39 + LP/SP/DT/FT + FT Oval	24/410	PE
1207	200	161	55x39	Overcap OVAL 55x39 + LP/SP/DT/FT + FT Oval	24/410	PET





SQM

Ref	Vol cc	 mm	 mm	Cap	Neck Finish	Material
-----	--------	--	--	-----	-------------	----------

Bottles

488	500	200	59x59	LP/DP/SP/FT	28/410	PE
703	700	225	64x64	Disc Push 254	Special	PE

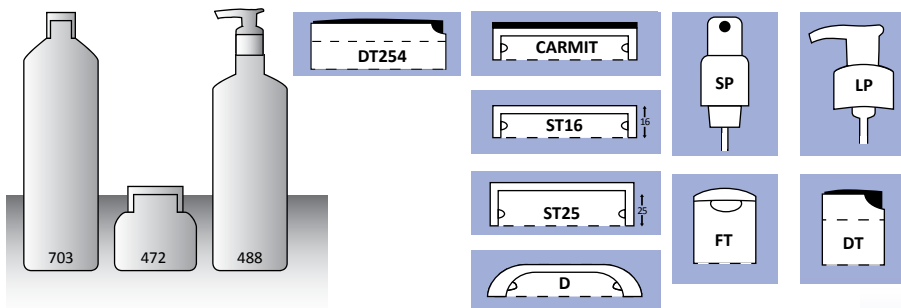

Jars

472	500	86	96x96	ST16/ST25/D/GAL/ CARMIT	89/400	PE
577	550	84	97x97	ST16/ST25/D/GAL/ CARMIT	89/400	PE





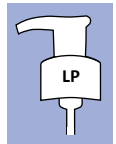
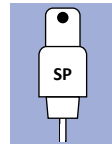
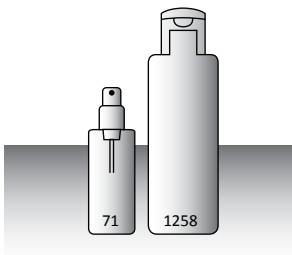

EST

Ref	Vol cc	 mm	 mm	Cap	Neck Finish	Material
71	76	116	27x41	SP/LP/DT/FT	20/410	PE
1258	250	190	39x55	SP/LP/DT/FT	24/415	PET









BALANCE

Ref	Vol cc	 mm	 mm	Cap	Neck Finish	Material
230	200	154	38x65	Special	Special	PE
228	250	170	40x66	Special	Special	PE
449	400	215	46x75	Special	Special	PE



Ref	Vol cc	 mm	 mm	Cap	Neck Finish	Material
235	200	160	48	Foam	38/410	PE
179	230	167	48	Foam	Foam	PE
311	250	185	48	Foam	38/410	PE
574	500	175	70	Foam	43/410	PE

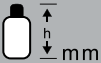

Ref	Vol cc	 mm	 mm	Cap	Neck Finish	Material
90	130	90	51	Special	38/400	PP
242	250	118	59	Special	38/400	PP
312	250	120	59	Special	38/400	PP
324	320	117	66	ST13 / ST12 / D / AL	58/400	PP



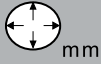

SMADAR

Ref	Vol cc	 mm	 mm	Cap	Neck Finish	Material
Bottles						
290	250	156	52	SP / DT / LP	28/410	PP
310	300	147	60	SP / DT / LP	28/410	PP
Jars						
2302	350	67	94	ST16/ST25/D/GAL	89/400	PET





TALC

Ref	Vol cc	 mm	 mm	Cap	Neck Finish	Material
372	360	160	63x50	Talc	Special	PE
274	430	167	80x45	Talc	Special	PE



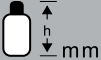

PAAMON

Ref	Vol cc	 mm	 mm	Cap	Neck Finish	Material
1104	100	100	47	SP / DT/ LP/ FT	24/410	PET
1160	160	117	54	SP / DT/ LP/ FT	24/410	PET
1280	280	140	58	SP / DT/ LP/ FT	24/410	PET
1300	300	140	60	SP / DT/ LP/ FT	24/410	PET
401	450			sw42		





GAYA

Ref	Vol cc	 mm	 mm	Cap	Neck Finish	Material
327	300	125	66x60	ST/LP/DT/FT	24/410	PETG
541	500	152	77x66	ST/LP/DT/FT	24/410	PETG



TEAMO

Ref	Vol cc	 mm	 mm	Cap	Neck Finish	Material
304	300	160	41x79	ST/LP/DT/FT	24/410	PP
523	600			LP/FT/DT/SW 124	24/410	PP



IND

Ref	Vol cc	 mm	 mm	Cap	Neck Finish	Material
393	400	170	70	Special	Special	PE
398	400	183	64	SP / DT / LP	28/410	PE
602	600	241	97X51	Special	Special	PE
603	600	258	69	Special	Special	PE
604	650	222	75	SP / DT / LP	28/410	PE
605	650	227	64	Special	Special	PE
1003	1000	290	76	SP / DT / LP	28/410	PE
1011	1000	72	154	Special	Special	PE
1023	1000					
1024	1000	200	87X87	SP / DT / LP	38/410	PE
1025	1000	274	83	SP / DT / LP / FT	28/410	PE

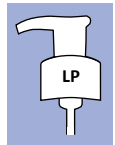
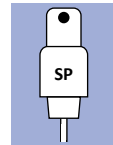

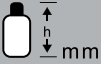
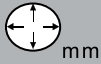

Special 1 to 200cc

Ref	Vol cc	 mm	 mm	Cap	Neck Finish	Material
93	120	115	65	LP/SP/DT/FT	24/415	PE
106	125	127	71x37	WP1002 WEENER		
133	125	155	67x30	Special	Special	PE
167	150	129	60	SP / DT / LP / FT	24/410	PETG
168	150	105	105x36	Special	Special	PE
160	170	177	60x44	Special + Overcap	Special	PVC
105	200			Crim 15	Special	PE
199	200	127	71x37	Control cap Tecnoplast		
203	200	140	77x36	wp1005	Special	
204	200					PVC
207	200	176	46	crim 20	Special	PE
209	200	171	80x30	Maplast	Special	PE
216	200	148	60	GP	Special	PE
231	200	171	55x37	ST/LP/DT/FT	24/410	PP
1206	200	141	73x34	LP/DT/FT/SP	28/410	PET
262	250			WP1002 WEENER		
214	260	170	42x42	Pco 28 / Overcap	Pco 28	PETG



Special 201 to 500cc

Ref	Vol cc	 mm	 mm	Cap	Neck Finish	Material
222	220	176	50x70	FT Pert Cap	Special	PP
220	250	156	80x40	Special	Special	
233	250					PET
288	250			GIFLOR (Crema)		
298	250					
257	250	127	96	ST/LP/DT/FT	28/400	
306	300	169	43x89	Bell	Special	PE
398	300	184	63x54	SW 450	Special	PE
329	300	222	40x65	DT/FT/LP/SP	24/410	PE
264b	300			ST/LP/DT/FT Mushroom Sanwa	28/410	
2302	300				89/400	PET
330	330	185	39x90	Maplast	Special	
361	350			24/415		PVC
355	350			Capsol		PE
352	350					PE
302	350	160	80x40	ST/LP/DT/FT	24/410	PE
379	380	205	90x36	Mantin	28/145	
451	400			Sanwa Mushroom	Special	PE
461	400	199	44x86	ST/LP/DT/FT	24/410	PE
395	400	210	55x45	CB Square	Special	PE
413	400	215	45x69	Wp1005	18/410	
450	450	201	83x42	Snap Square Sanwa	Special	PP
401	450			sw42		
473	473	163	100	ST/LP/DT/FT	24/415	PE
494	500				63/400	PET
491	500					PET
296						
429				Special	18/410	PE
413	400	215	45x69	Wp1005	18/410	

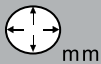

Special 501 to 1000cc

Ref	Vol cc	 mm	 mm	Cap	Neck Finish	Material
502	500	155	74	LP	24/410	PE
506	500	224	88x41	Snap Square Sanwa	Special	PP
508	500	239	79x50	Yacum 70	Special	PE
527	500					
528	500	86	106	ST15/D 454 /AL	83/400	PE
562	500	227	50x62	Lumson Cap	Special	
598	750	185	135	ST/LP/DT/FT	28/410	PE
702	700	247	57x87	SW 510	Special	PE
758	750	225	69x75	NYB Push	Special	PE
761	750	230	96	CB	Pco 28	PE
763	750	232	77	CB	Pco 28	PE
766	750			Special	Special	PE
801	750				70/400	
900	900	269	66x119	LP / TR	28/410	PE



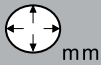

ONE LITER

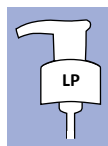
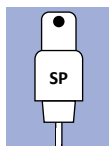
Ref	Vol cc	 mm	 mm	Cap	Neck Finish	Material
Luna						
1002	1000	266	105	CB	Special	PE
Family						
1006	1000	275	100	WP1001	Special	PE
Super Class						
1009	1000	262	100	WP1001	Special	PE
DG PLUS						
1013	1000	285	75	SP / DT / LP	28/410	PE







MG

Ref	Vol cc	 mm	 mm	Cap	Neck Finish	Material
432	400	196	45x77	CB Zeus	special	PE
704	750	245	56x86	CB Zeus	special	PE





SASA



Ref	Vol cc	 mm	 mm	Cap	Neck Finish	Material
Bottles						
389	350	167	47x81	FT 510	special	PE
702	700	245	56x86	FT 510	special	PE
Jars						
360	350	71	90x105	ST/ AL(Plastic)	83/400	PP



WS



Ref	Vol cc	 mm	 mm	Cap	Neck Finish	Material
Bottles						
1249	250	120	69	DT/FT/LP/SP	24/410	PET
Jars						
2253	250	52	97	ST/D/AL(plastic)/ALU	89/400	PET



Ref	Vol cc	 mm	 mm	Cap	Neck Finish	Material
1261	250	145	42x70	DT/FT/LP/SP	28/410	PET
452	400	185	45x90	wp1001	Special	PE/PP
1408	400	165	84x46	DT/FT/LP/SP	28/410	PET
751	750	235	54x88	wp1001	Special	PE



SAN

Ref	Vol CC	 mm	 mm	Cap	Neck Finish	Material
433	400	188	52x60	Lumson Cap	Special	PE
470	400	187	52x60	CAP Special + OV SAN Soap	28mm	PE
562	500	227	50x62	Lumson Cap	Special	PE

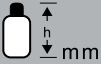

NL

Ref	Vol cc	 mm	 mm	Cap	Neck Finish	Material
316	300	133	62	DT/FT/LP/SP	28/400 28/410	PE
566	500	103	96	DT/FT/LP/SP	28/410	PE

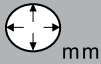

NETA

Ref	Vol cc	 mm	 mm	Cap	Neck Finish	Material
335	345	160	74x49	Maxi WP	34/400	PE/PP