

SERIE526

SET DI MOBILI MODULARI (7PCS) - ESTENSIONE CON
ARMADIO A 4 CASSETTI (RIF.16627)

ACERO
STEEL

MDF

67,90Kg



INCLUDE

x1	16494	ARMADIO A MURO (RIF. 54327)
x1	16497	PANNELLO MDF 680X500X40MM (RIF. 16627/16628/16500)
x2	16498	PANNELLO 680X340X25MM (RIF.54327)
x1	16627	ARMADIO CON 4 CASSETTI (REF.54327)
x2	16561	BARRA DI SUPPORTO (RIF.54327)

Il modulo include cordoli frontali e laterali

JBM CAMPLLONG S.L.

CIM La Selva - Ctra. Aeropuerto, Km 1,6 Nave 2.2 CP 17185
Vilobí d'Onyar - GIRONA - ESB17419292 - SPAIN

www.jbmcamp.com
jbmcamp@jbmcamp.com
+34 972 24 55 53

COMPONENTI

16627

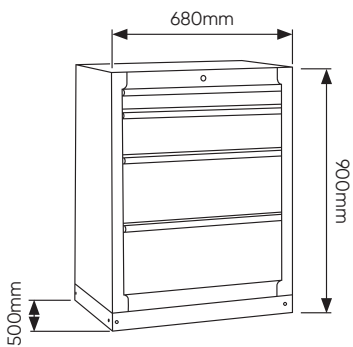

16494

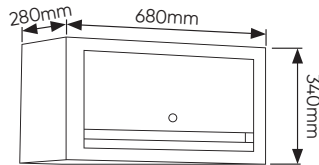

16498

338x25x680mm

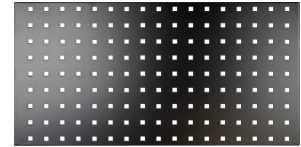

16497

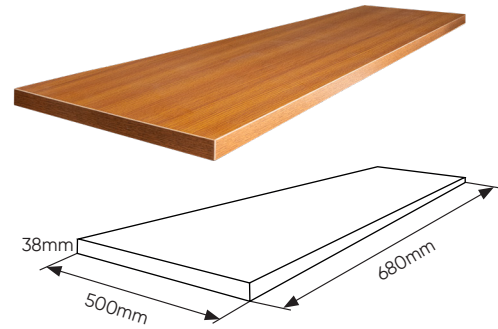

16561



COMPONENTI

SERIE526

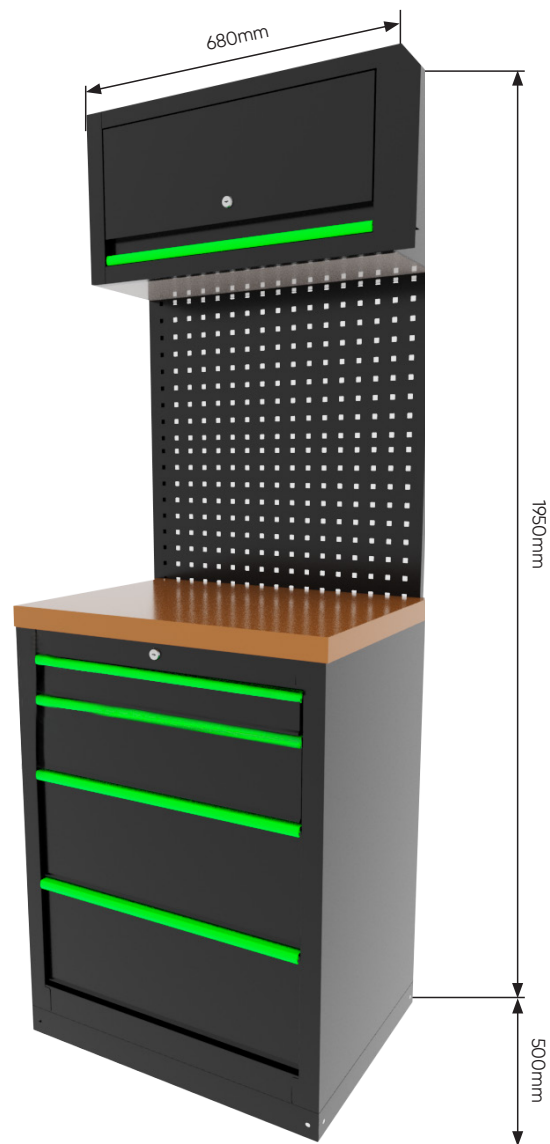

COLORI DISPONIBILI

SERIE526R



SET DI MANIGLIE

18005

SERIE526B



SET DI MANIGLIE

18006

SERIE526Y

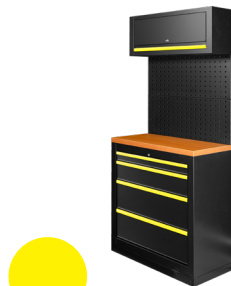

SET DI MANIGLIE

18007

SERIE526O



SET DI MANIGLIE

18008

SERIE526G

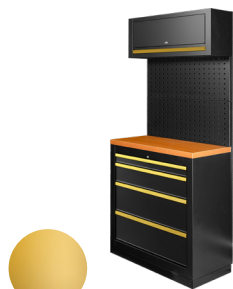

SET DI MANIGLIE

18009

SERIE526P



SET DI MANIGLIE

18010

SERIE526K



SET DI MANIGLIE

18019

SERIE526S



SET DI MANIGLIE

18020



I nostri set modulari vengono forniti con maniglie verdi di serie, ma ricevi anche le maniglie nel colore che preferisci dalla nostra palette. In questo modo puoi personalizzare facilmente e velocemente il tuo set per abbinarlo ai colori aziendali della tua officina. Un metodo di personalizzazione pratico che ti aiuta a mantenere un'immagine professionale e coerente nel tuo spazio di lavoro.