

## SERIE526

CONJUNTO DE MÓVEIS MODULARES (7PCS) - EXTENSÃO  
COM ARMÁRIO DE 4 GAVETAS (REF.16627)

ACERO  
STEEL

MDF

67,90Kg



## INCLUI

x1	16494	ARMÁRIO DE PAREDE (REF. 54327)
x1	16497	PLACA DE MDF 680X500X40MM (REF. 16627/16628/16500)
x2	16498	PANEL DE FERRAMENTAS 680X340X25 MM (REF. 54327)
x1	16627	ARMÁRIO COM 4 GAVETAS (REF.54327)
x2	16561	BARRA DE SUPORTE (REF.54327)

O módulo inclui lancis frontais e laterais

**JBM CAMPLLONG S.L.**

CIM La Selva - Ctra. Aeropuerto, Km 1,6 Nave 2.2 CP 17185  
Vilobí d'Onyar - GIRONA - ESB17419292 - SPAIN

[www.jbmcamp.com](http://www.jbmcamp.com)  
[jbm@jbmcamp.com](mailto:jbm@jbmcamp.com)  
+34 972 24 55 53

COMPONENTES

16627

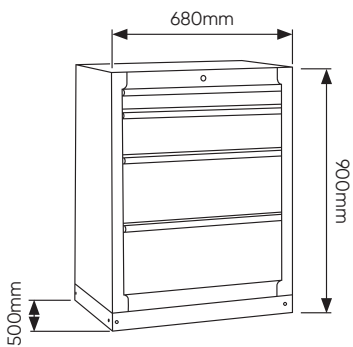

16494

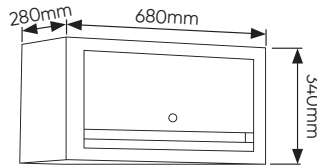

16498

338x25x680mm

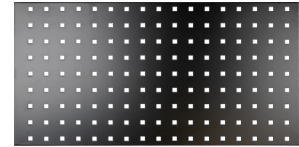

16497

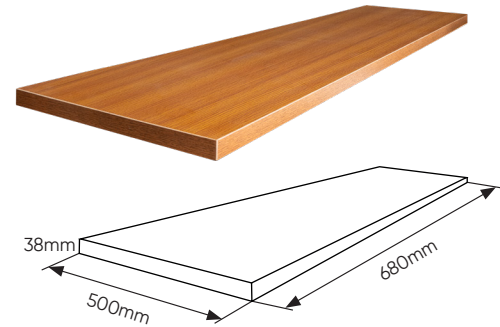

16561



COMPONENTES

SERIE526

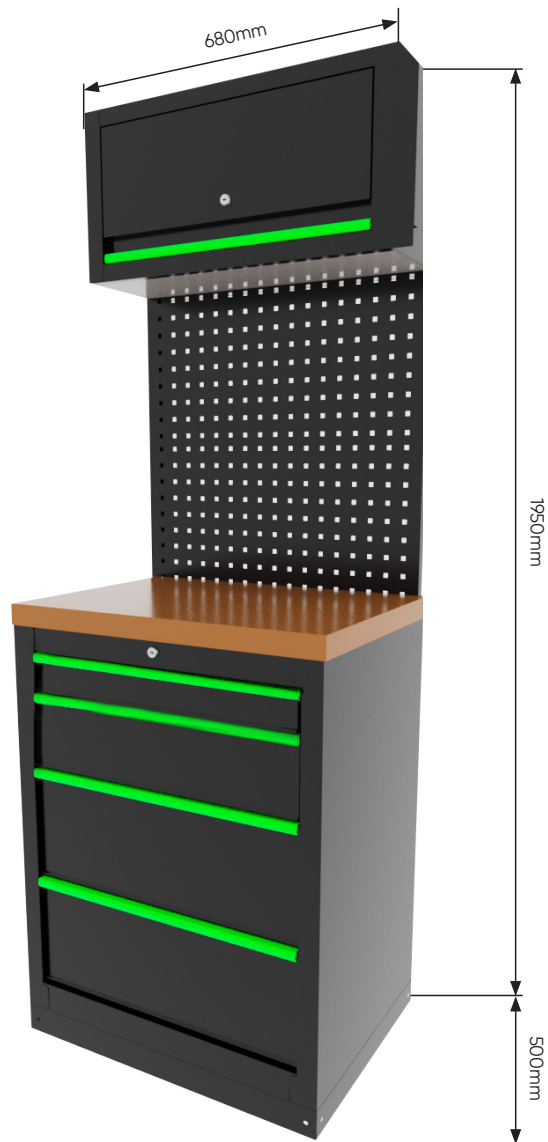

**CORES DISPONÍVEIS**
**SERIE526R**



JOGO DE PUXADORES

18005

**SERIE526B**

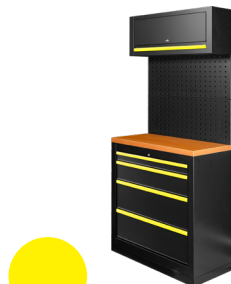

JOGO DE PUXADORES

18006

**SERIE526Y**

JOGO DE PUXADORES

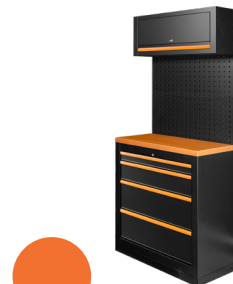
18007

**SERIE526O**

JOGO DE PUXADORES

18008

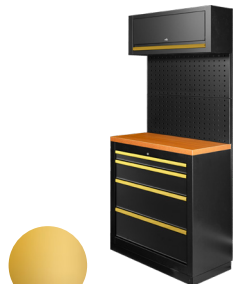
**SERIE526G**

JOGO DE PUXADORES

18009

**SERIE526P**



JOGO DE PUXADORES

18010

**SERIE526K**

JOGO DE PUXADORES

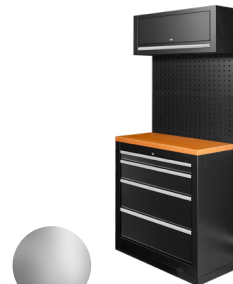
18019

**SERIE526S**

JOGO DE PUXADORES

18020



Os nossos conjuntos modulares são entregues com puxadores verdes de série, mas também recebe puxadores na cor que escolher dentro da nossa paleta. Assim, pode personalizar o seu conjunto de forma rápida e simples para combinar com as cores corporativas da sua oficina. Um método de personalização prático que o ajuda a manter a imagem profissional e coerente do seu espaço de trabalho.