

## SERIE526

MODULARES MÖBEL SET (7PCS) - ERWEITERUNG MIT  
SCHRANK MIT 4 SCHUBLADEN (REF.16627)

ACERO  
STEEL

MDF

67,90Kg



## BEINHALTET

x1	16494	WANDSCHRANK (ART. 54327)
x1	16497	MDF-PLATTE 680X500X40MM (ART. 16627/16628/16500)
x2	16498	STECKTAFEL 680X340X25MM (ART.54327)
x1	16627	4-SCHUBLADEN-SCHRANK (REF.54327)
x2	16561	STÜTZSTANGE (ART.54327)

Das Modul enthält vordere und seitliche Bordsteine

**JBM CAMPLLONG S.L.**

CIM La Selva - Ctra. Aeropuerto, Km 1,6 Nave 2.2 CP 17185  
Vilobí d'Onyar - GIRONA - ESB17419292 - SPAIN

[www.jbmcamp.com](http://www.jbmcamp.com)  
[jbm@jbmcamp.com](mailto:jbm@jbmcamp.com)  
+34 972 24 55 53

KOMPONENTEN

16627

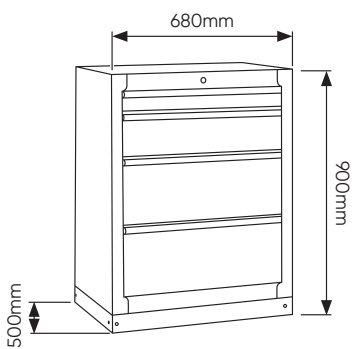

16494

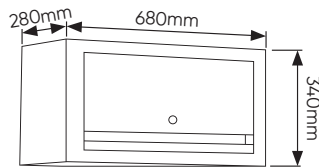

16498

338x25x680mm

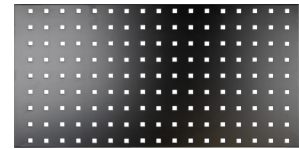

16497

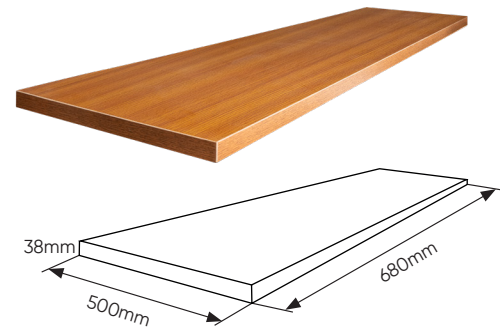

16561



KOMPONENTEN

SERIE526

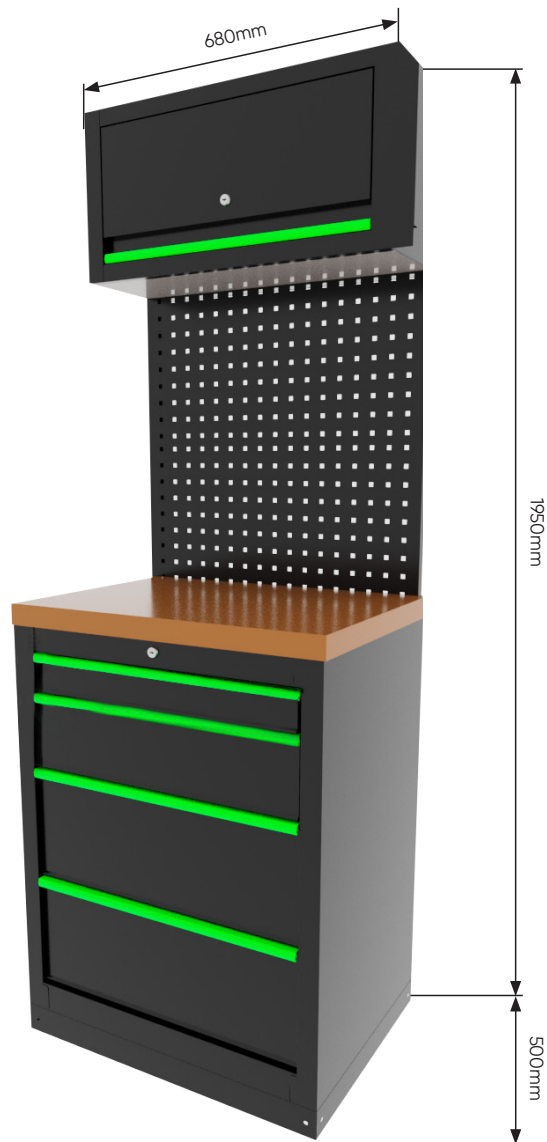

VERFÜGBARE FARBEN

SERIE526R

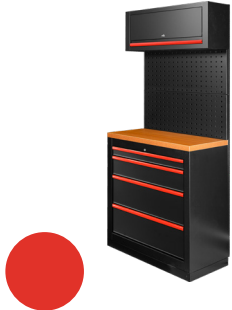

SCHRANKGRIFF-SET

18005

SERIE526B



SCHRANKGRIFF-SET

18006

SERIE526Y

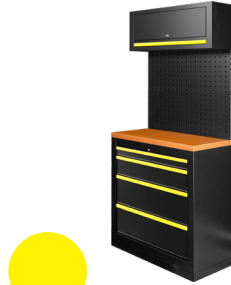

SCHRANKGRIFF-SET

18007

SERIE526O

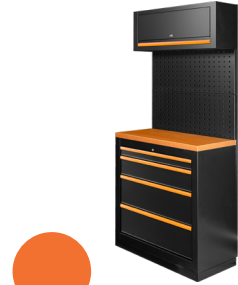

SCHRANKGRIFF-SET

18008

SERIE526G

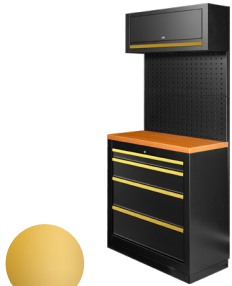

SCHRANKGRIFF-SET

18009

SERIE526P



SCHRANKGRIFF-SET

18010

SERIE526K



SCHRANKGRIFF-SET

18019

SERIE526S



SCHRANKGRIFF-SET

18020



Unsere modularen Sets werden mit standardmäßigen grünen Griffen geliefert, aber Sie erhalten auch Griffe in der von Ihnen gewählten Farbe aus unserer Palette. So können Sie Ihr Set schnell und einfach an die Unternehmensfarben Ihrer Werkstatt anpassen. Eine praktische Personalisierungsmöglichkeit, die Ihnen hilft, ein professionelles und einheitliches Erscheinungsbild in Ihrem Arbeitsbereich zu bewahren.