

SERIE526**MODULAR FURNITURE SET (7PCS) - EXTENSION WITH 4 DRAWER CABINET (REF.16627)****ACERO
STEEL****MDF****67,90Kg****IT CONTAINS**

x1	16494	WALL CABINET (REF. 54327)
x1	16497	MDF BOARD 680X500X40MM (REF. 16627/16628/16500)
x2	16498	PEG BOARD 680X340X25MM (REF.54327)
x1	16627	4-DRAWER CABINET (REF.54327)
x2	16561	SUPPORT BAR (REF.54327)

The module includes front and side curbs

JBM CAMPLLONG S.L.CIM La Selva - Ctra. Aeropuerto, Km 1,6 Nave 2.2 CP 17185
Vilobí d'Onyar - GIRONA - ESB17419292 - SPAIN**www.jbmcamp.com**
jbm@jbmcamp.com
+34 972 24 55 53

COMPONENTS

16627

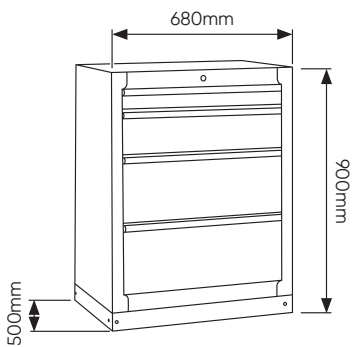

16494

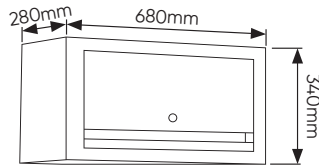

16498

338x25x680mm

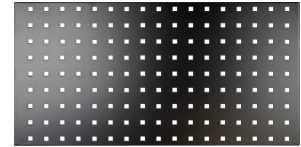

16497

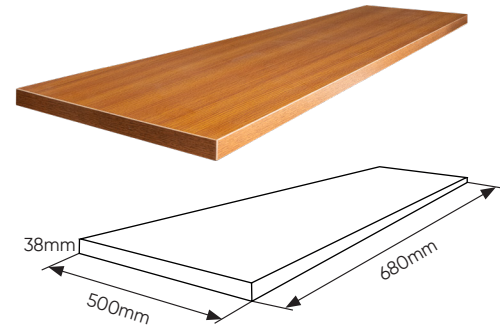

16561



COMPONENTS

SERIE526

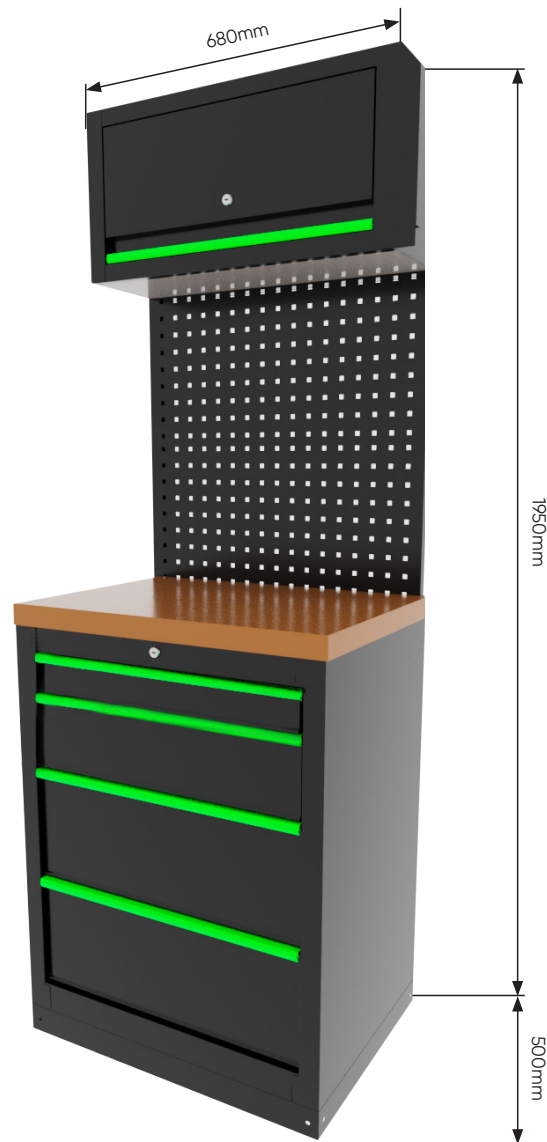

AVAILABLE COLORS

SERIE526R

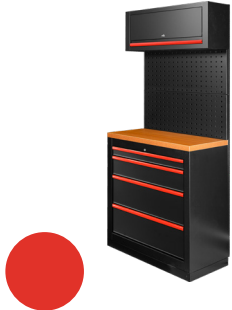

CABINET PULL HANDLE SET

18005

SERIE526B



CABINET PULL HANDLE SET

18006

SERIE526Y



CABINET PULL HANDLE SET

18007

SERIE526O

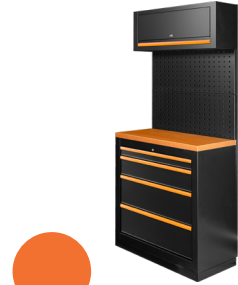

CABINET PULL HANDLE SET

18008

SERIE526G

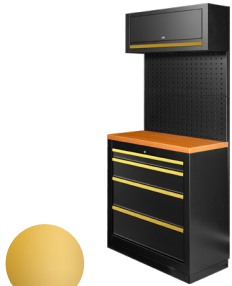

CABINET PULL HANDLE SET

18009

SERIE526P



CABINET PULL HANDLE SET

18010

SERIE526K



CABINET PULL HANDLE SET

18019

SERIE526S



CABINET PULL HANDLE SET

18020



Our modular furniture sets are delivered with standard green handles, but you also receive handles in the color of your choice from our palette. This way, you can easily and quickly customize your set to match your workshop's corporate colors. A practical personalization method that helps you maintain a professional and consistent image in your workspace.